



US00D859906S

(12) **United States Design Patent** (10) **Patent No.:** **US D859,906 S**  
**Salamon-Hickey** (45) **Date of Patent:** **\*\* Sep. 17, 2019**

(54) **SOUP BAR**

(71) Applicant: **Campbell Soup Company**, Camden, NJ (US)

(72) Inventor: **Talia Salamon-Hickey**, Marlton, NJ (US)

(73) Assignee: **Campbell Soup Company**, Camden, NJ (US)

(\*\*) Term: **15 Years**

(21) Appl. No.: **29/618,294**

(22) Filed: **Sep. 20, 2017**

(51) **LOC (12) Cl.** ..... **07-02**

(52) **U.S. Cl.**

USPC ..... **D7/347**; D34/14; D6/699.3

(58) **Field of Classification Search**

USPC ..... D6/536, 539, 663, 664, 665, 667, 668, D6/668.1, 668.2, 672, 675.1, 675.3, 680, D6/680.2, 699-699.5; D7/347; D30/127, D30/128; D34/14, 19

CPC ... A47B 31/00; A47B 31/02; A47B 2031/002; A47B 2031/008; A47B 2031/023; A47B 2031/026; B62B 3/10; B62B 2202/67; B67D 2210/00133

See application file for complete search history.

(56) **References Cited**

**U.S. PATENT DOCUMENTS**

D43,741 S *	3/1913	Faissole	.....	D6/686
1,850,193 A *	3/1932	Zahner	.....	F24C 7/00
				126/33
D185,939 S *	8/1959	Frick	.....	D34/14
D188,154 S *	6/1960	Frick	.....	D34/14
D197,394 S *	1/1964	Werner	.....	D7/347
D228,063 S	8/1973	Keeshin et al.		
D235,009 S *	4/1975	Thompson	.....	D34/14
4,572,598 A	2/1986	Moore et al.		
D326,024 S	5/1992	Boyd et al.		
D346,514 S	5/1994	Barish		

D349,617 S	8/1994	Herman		
D371,660 S	7/1996	Wilson		
D383,013 S *	9/1997	Newhouse	.....	D6/675.1
D383,016 S	9/1997	Mckee		
D385,429 S *	10/1997	Biggel	.....	D6/642
D413,211 S	8/1999	Baluk et al.		
D443,069 S	5/2001	Horton et al.		
6,598,514 B2	7/2003	Leggi et al.		
D515,845 S	2/2006	Knudsen et al.		

(Continued)

**FOREIGN PATENT DOCUMENTS**

CA 166317 8/2016

**OTHER PUBLICATIONS**

“Ex Parte Quayle Action,” for U.S. Appl. No. 29/547,371 mailed Dec. 22, 2017 (6 pages).

*Primary Examiner* — Mary Ann Calabrese

*Assistant Examiner* — Catherine Ho

(74) *Attorney, Agent, or Firm* — Pauly, DeVries Smith & Deffner LLC

(57) **CLAIM**

I claim the ornamental design for a soup bar, as shown and described.

**DESCRIPTION**

FIG. 1 is a top left front perspective view of a soup bar showing our new design.

FIG. 2 is a front elevation view thereof.

FIG. 3 is a rear elevation view thereof.

FIG. 4 is a right side elevation view thereof.

FIG. 5 is a left side elevation view thereof.

FIG. 6 is a top plan view thereof; and,

FIG. 7 is a bottom plan view thereof.

The broken line portion of the figure drawings is included to show portions of the article that form no part of the claimed design.

**1 Claim, 5 Drawing Sheets**

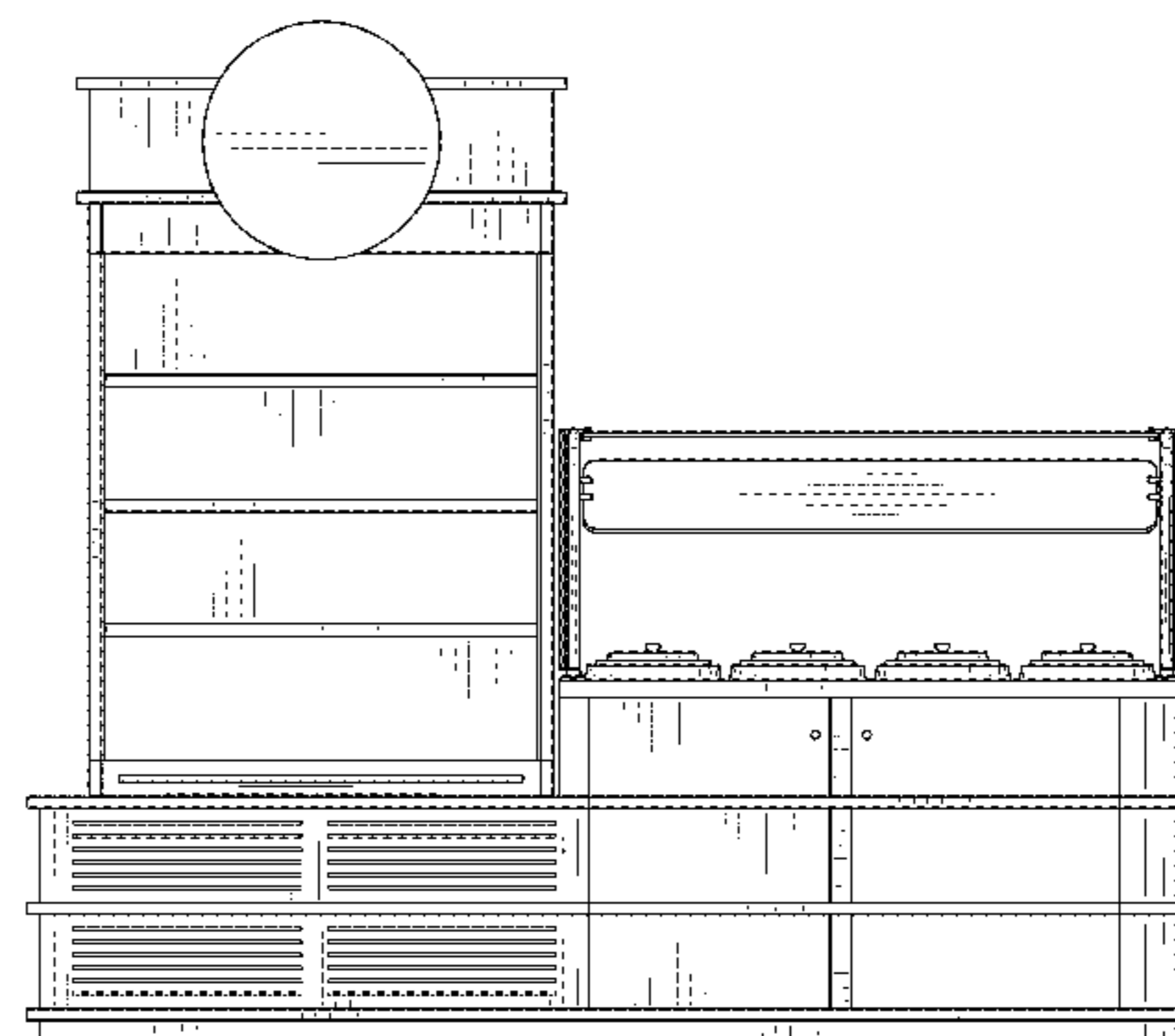
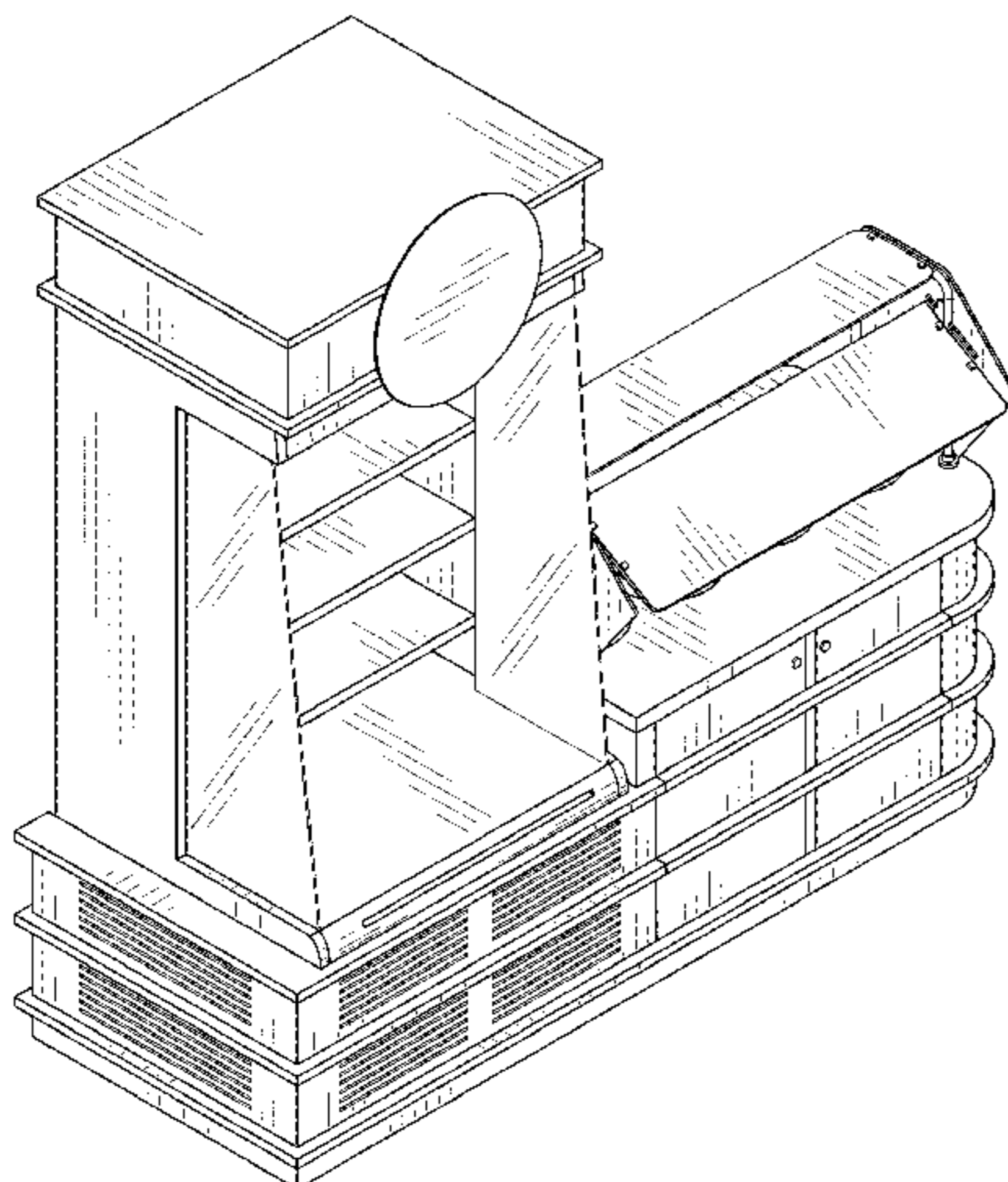

(56)

**References Cited**

U.S. PATENT DOCUMENTS

D591,551 S \* 5/2009 Boisvert ..... D7/339  
D618,008 S 6/2010 Verhaar  
D651,024 S \* 12/2011 Shenkin ..... D6/675.3  
D730,665 S \* 6/2015 Murakami ..... D6/675.3

\* cited by examiner

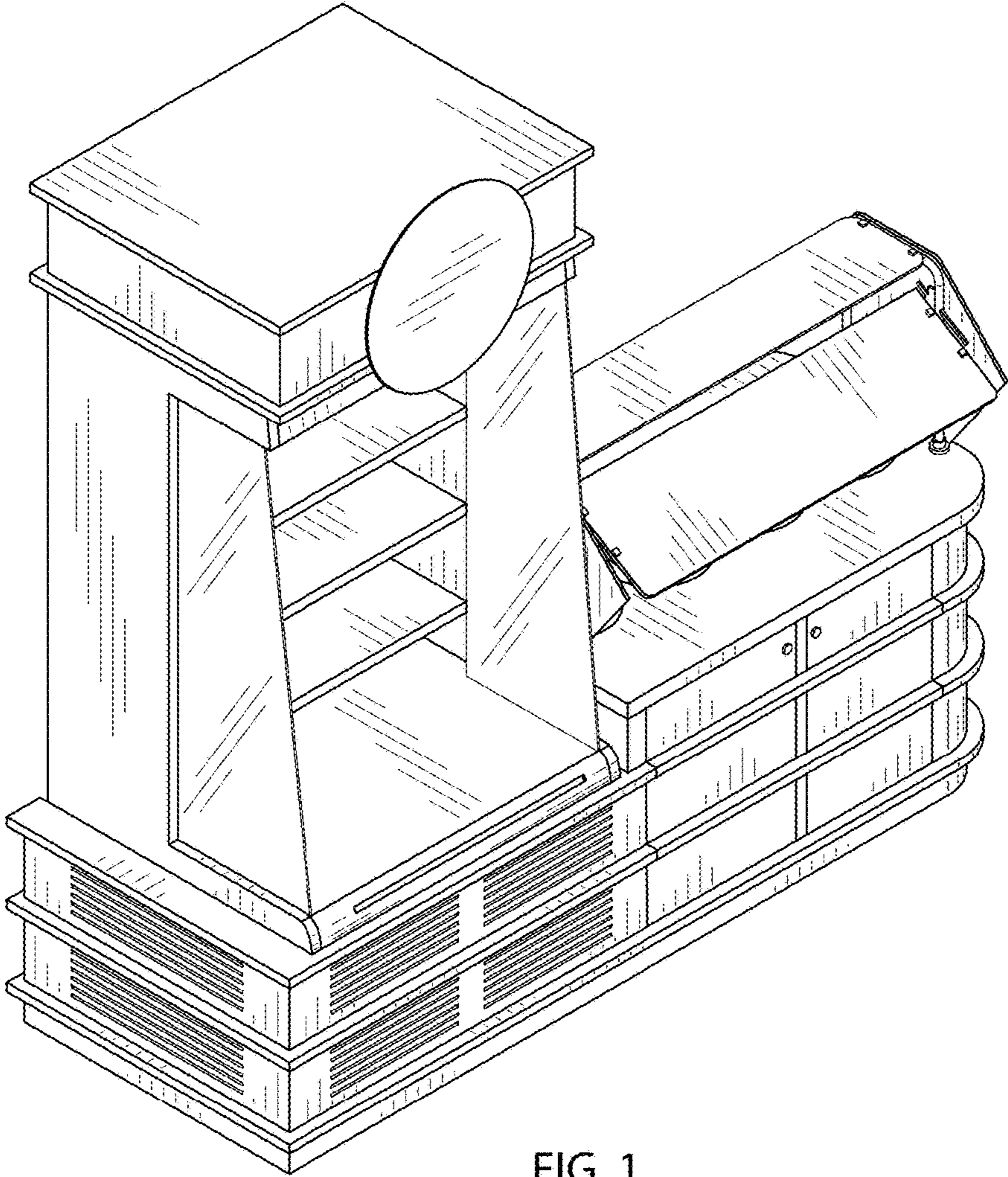

FIG. 1

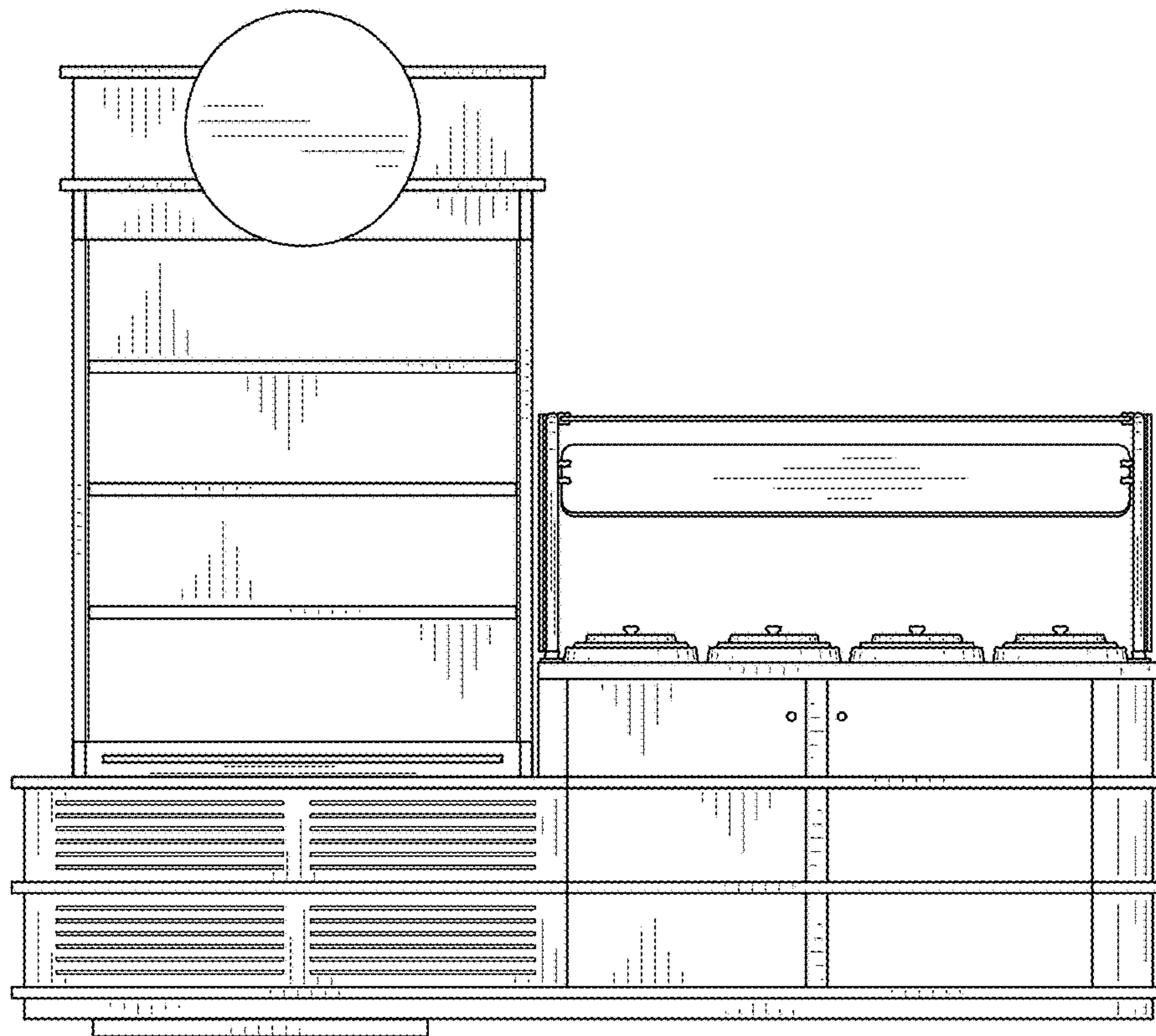

FIG. 2



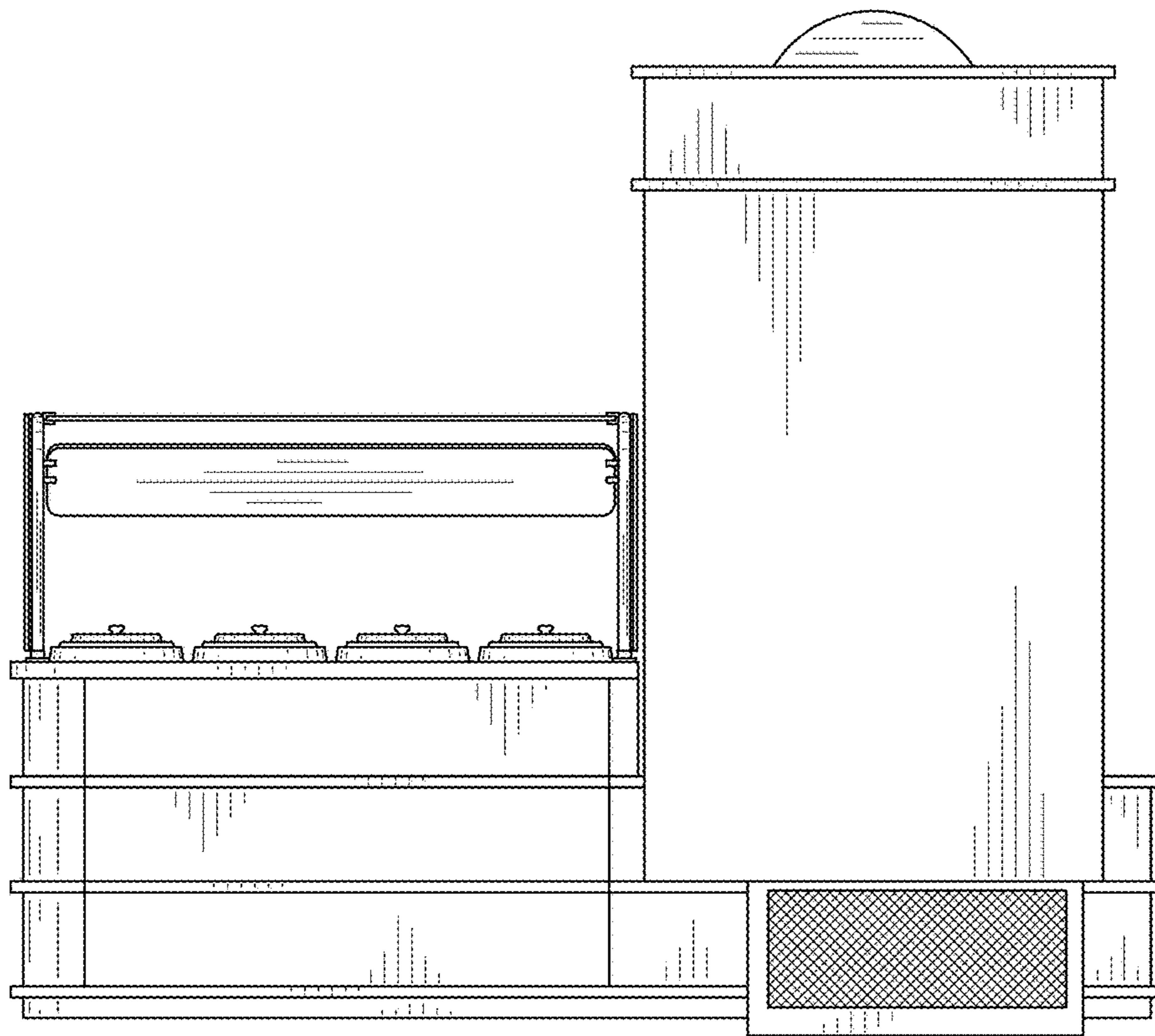

FIG. 3

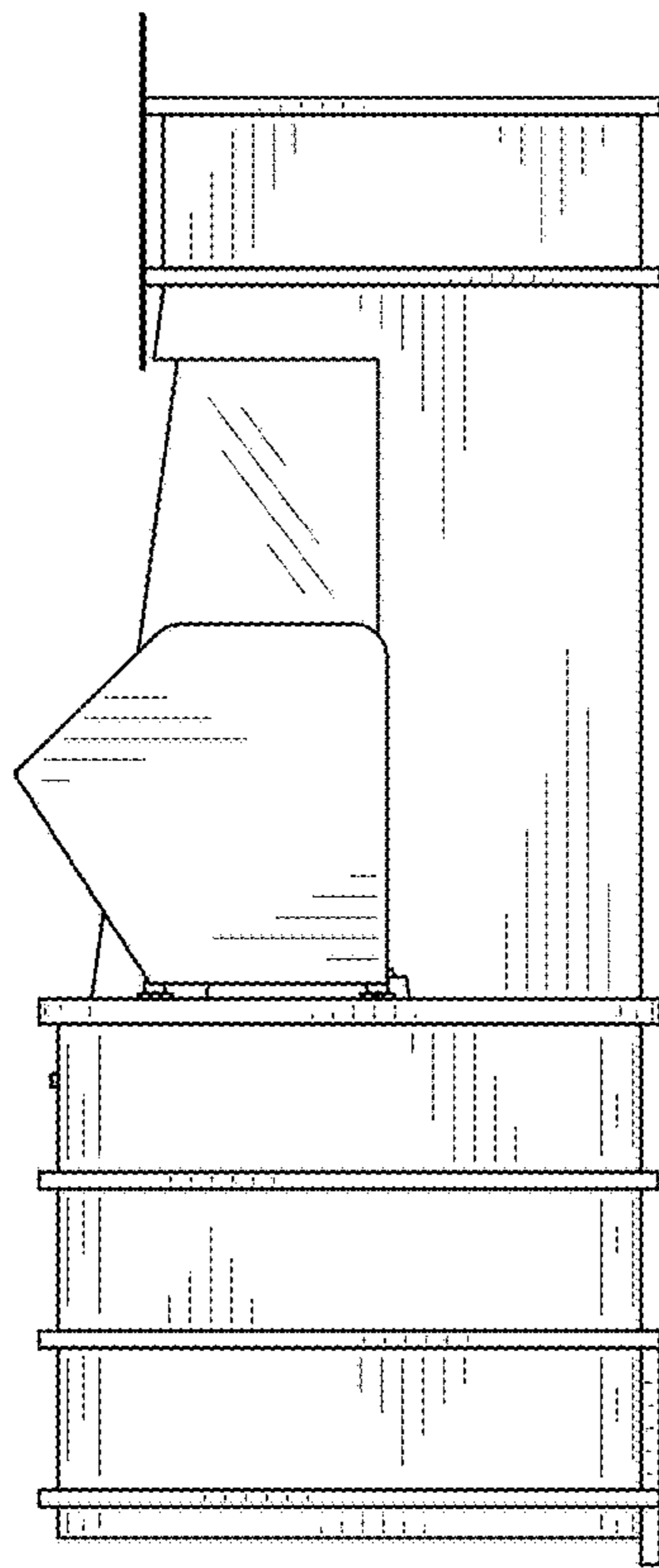

FIG. 4

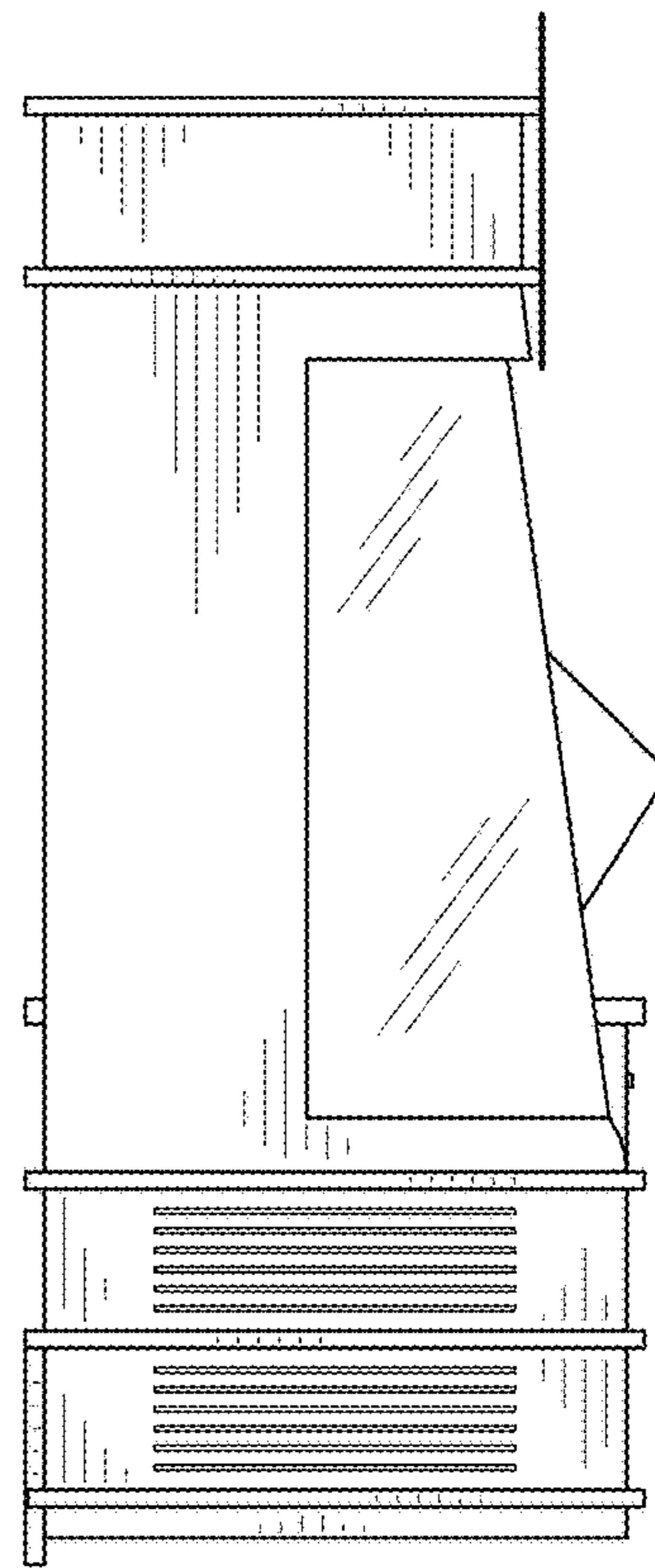

FIG. 5

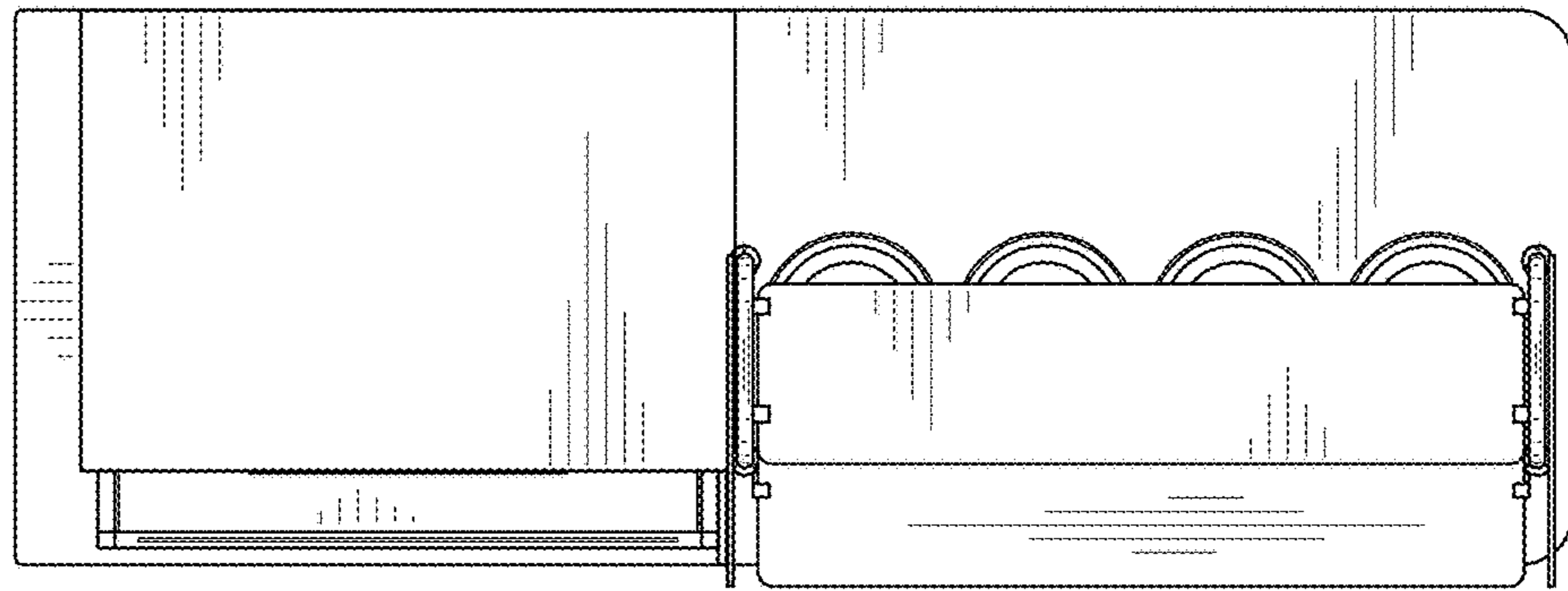

FIG. 6

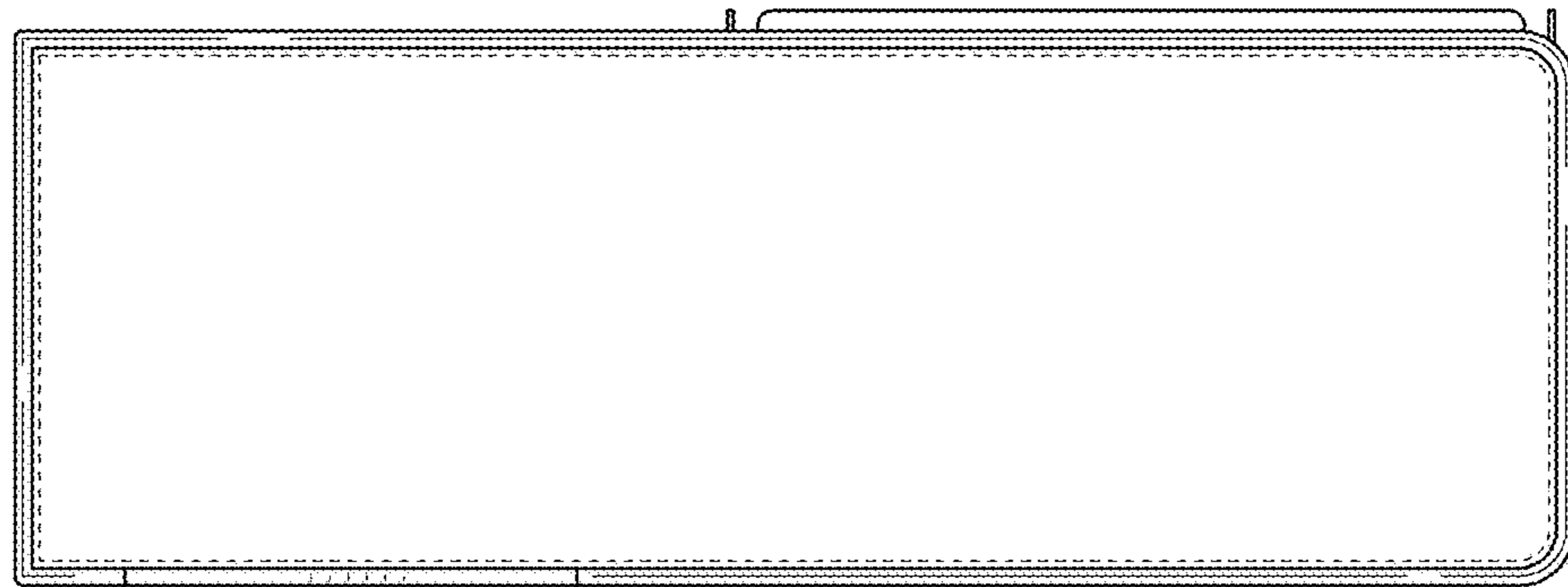

FIG. 7