



US00D859881S

(12) **United States Design Patent** (10) **Patent No.:** **US D859,881 S**
McGarry (45) **Date of Patent:** **** Sep. 17, 2019**

(54) **SHOWER TIDY**

(71) Applicant: **THE TIDYSHOWER COMPANY,**
Westport (IE)

(72) Inventor: **Sean David McGarry,** Westport (IE)

(73) Assignee: **THE TIDYSHOWER COMPANY,**
Westport (IE)

(**) Term: **15 Years**

(21) Appl. No.: **29/682,126**

(22) Filed: **Mar. 1, 2019**

Related U.S. Application Data

(62) Division of application No. 29/607,459, filed on Jun. 13, 2017, now Pat. No. Des. 850,147.

(30) **Foreign Application Priority Data**

Dec. 13, 2016 (EP) 003516160

(51) **LOC (12) Cl.** **23-02**

(52) **U.S. Cl.**
USPC **D6/525**

(58) **Field of Classification Search**

USPC D6/529, 329, 397, 524, 525, 562, 536,
D6/540, 574; D3/308, 313, 315;
D7/500, 505, 555, 601, 637, 701;
D11/131, 143, 146, 152; D28/73;
47/41.1, 65.5, 66.1, 66.6, 66.7, 69;
211/13.1, 71.01, 72, 74, 75, 86.01, 87.01;
248/205.1, 235, 317; D23/304; D8/354
CPC E03C 1/06; B05B 15/60

See application file for complete search history.

(56) **References Cited**

U.S. PATENT DOCUMENTS

D268,383 S *	3/1983	Peabody	D6/529
D442,812 S	5/2001	McMahon et al.	
D549,503 S	8/2007	Nagoya	
D690,533 S	10/2013	Majcher	
D699,474 S	2/2014	Roberts	
D850,147 S *	6/2019	McGarry	D6/525

* cited by examiner

Primary Examiner — Wan Laymon

Assistant Examiner — Mark Booker

(74) *Attorney, Agent, or Firm* — Klein, O'Neill & Singh, LLP

(57) **CLAIM**

The ornamental design for a shower tidy, as shown and described.

DESCRIPTION

FIG. 1 is a front elevation view of a shower tidy in accordance with my design;
FIG. 2 is a bottom plan view of the shower tidy of FIG. 1;
FIG. 3 is a side elevation view of the shower tidy of FIG. 1, taken from the left side of FIG. 1;
FIG. 4 is a top plan view of the shower tidy of FIG. 1;
FIG. 5 is a side elevation view of the shower tidy of FIG. 1, taken from the right side of FIG. 1;
FIG. 6 is a perspective view of the shower tidy of FIG. 1, taken from the bottom and front of FIG. 1; and
FIG. 7 is a rear elevation view of the shower tidy of FIG. 1.

1 Claim, 2 Drawing Sheets

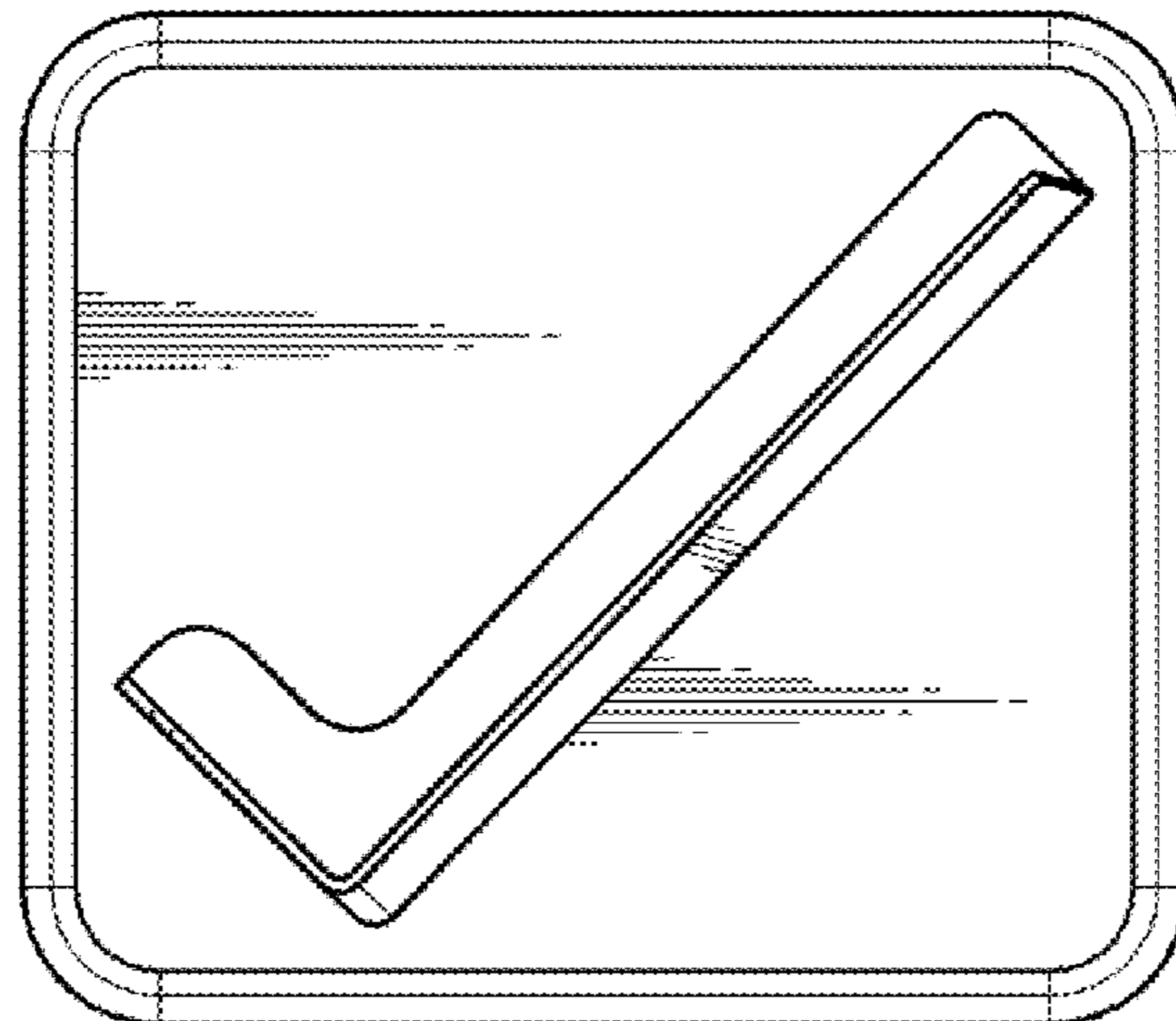

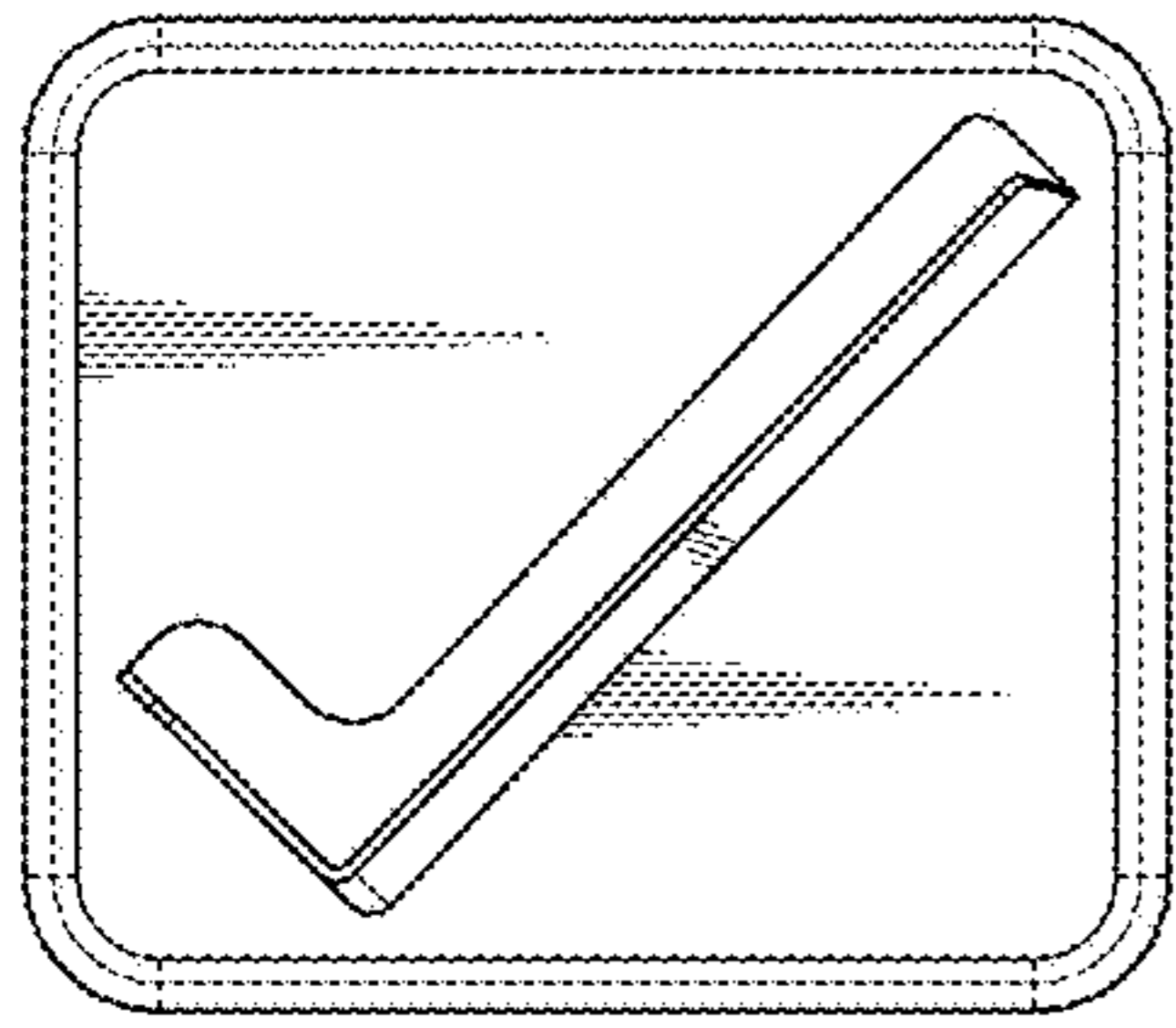

FIG. 1

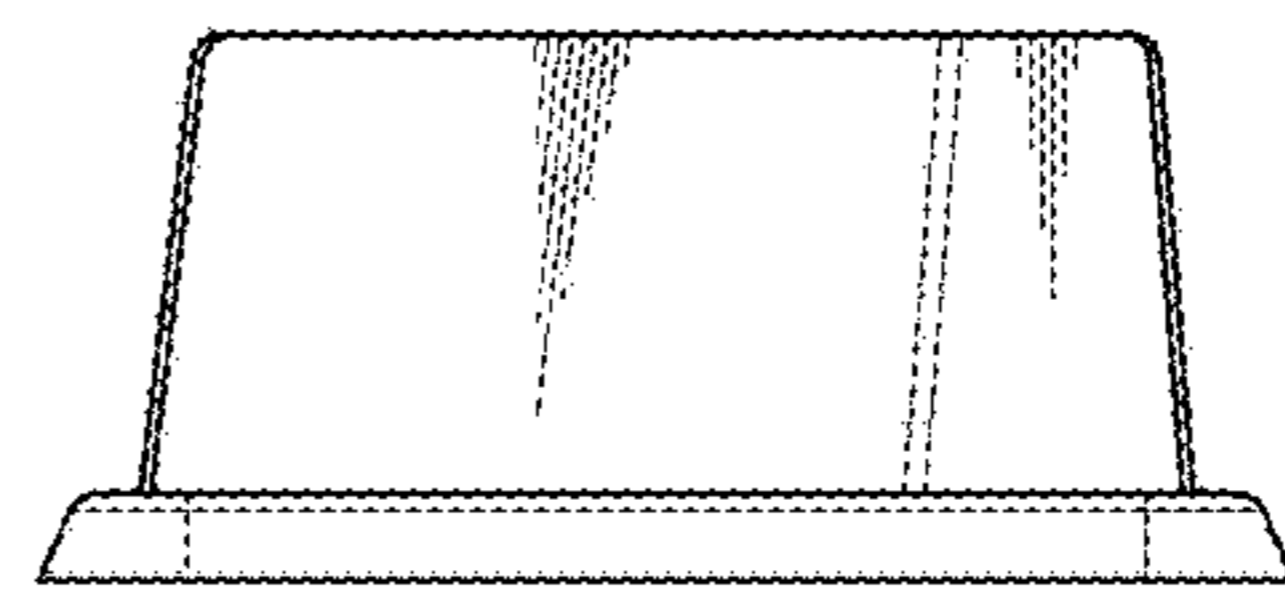

FIG. 2

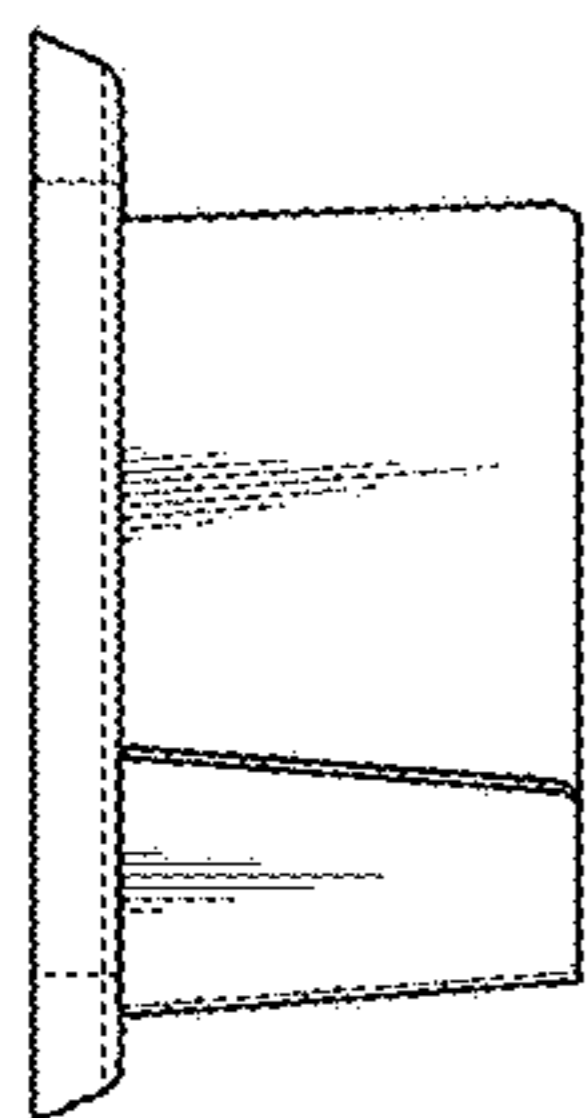

FIG. 3

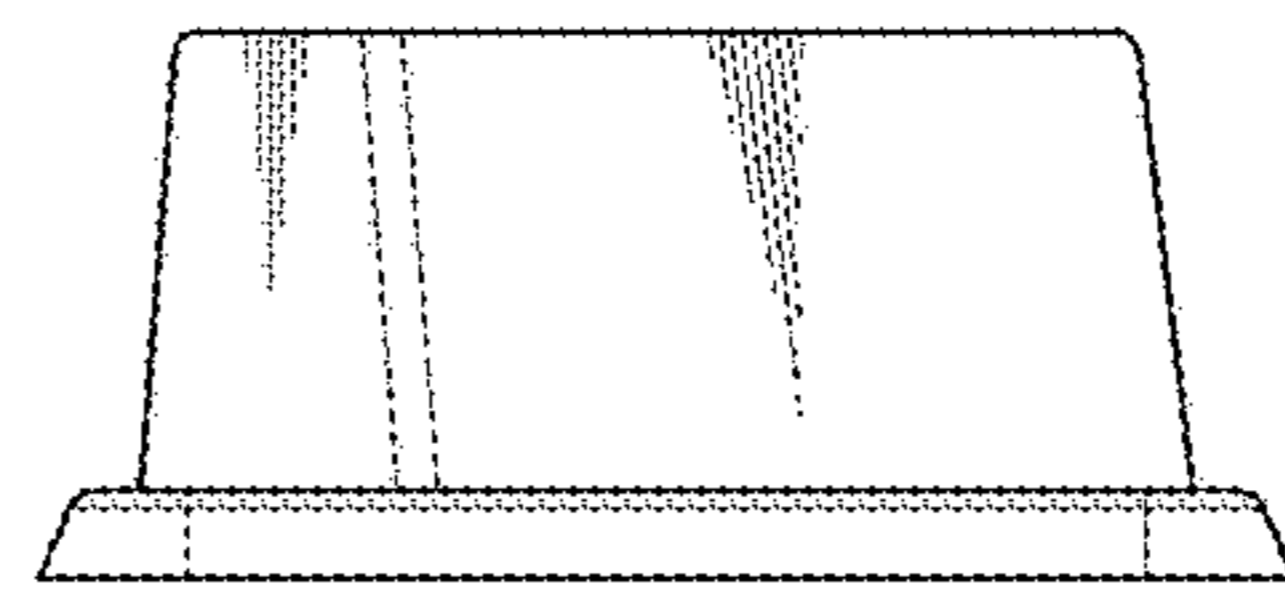

FIG. 4

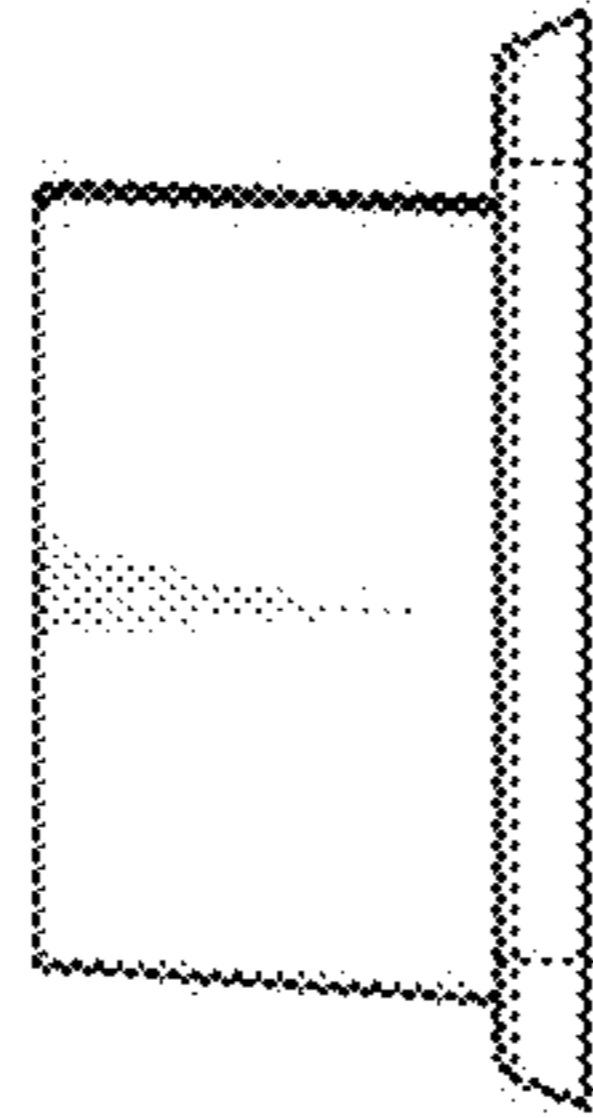

FIG. 5

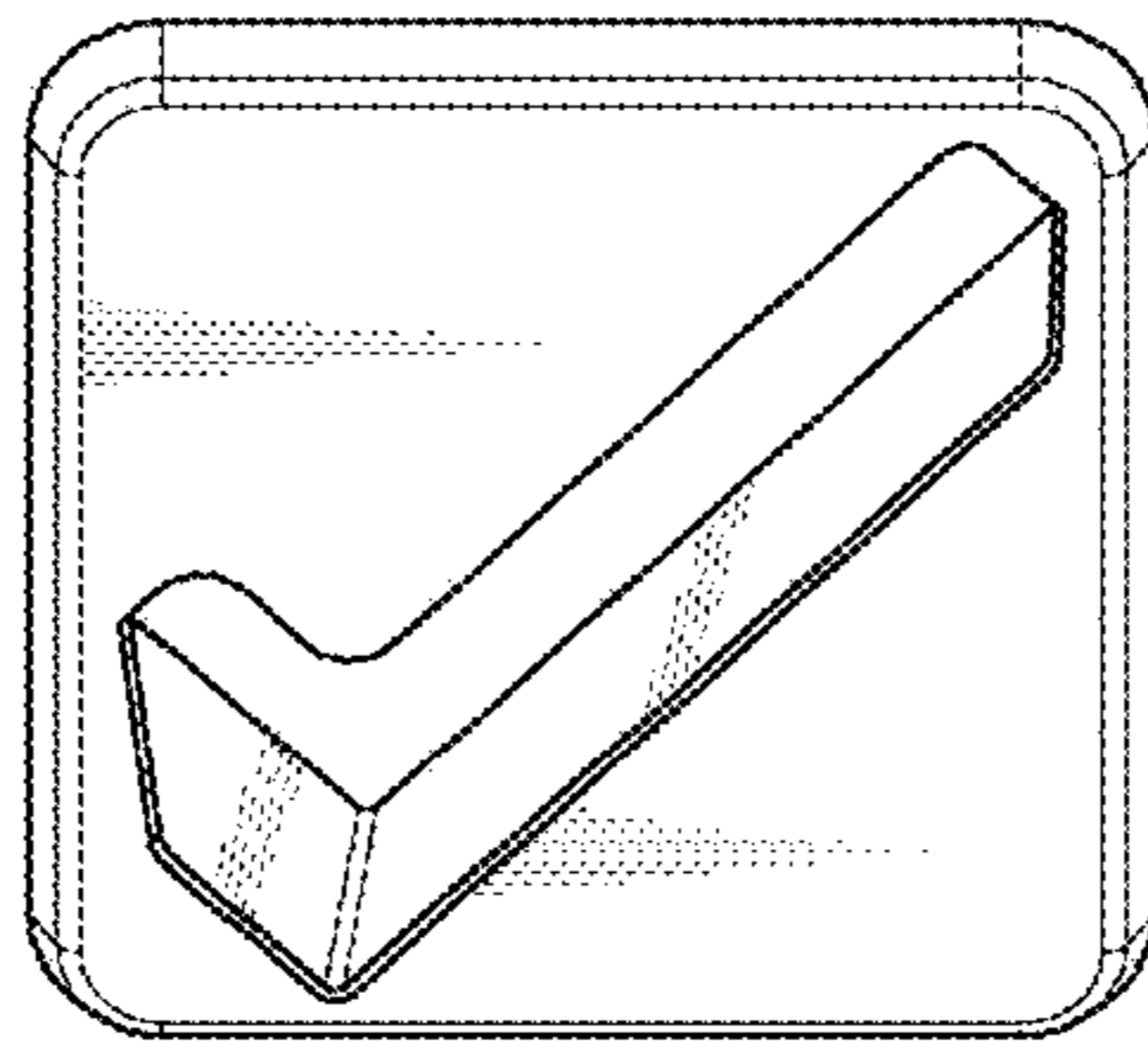

FIG. 6

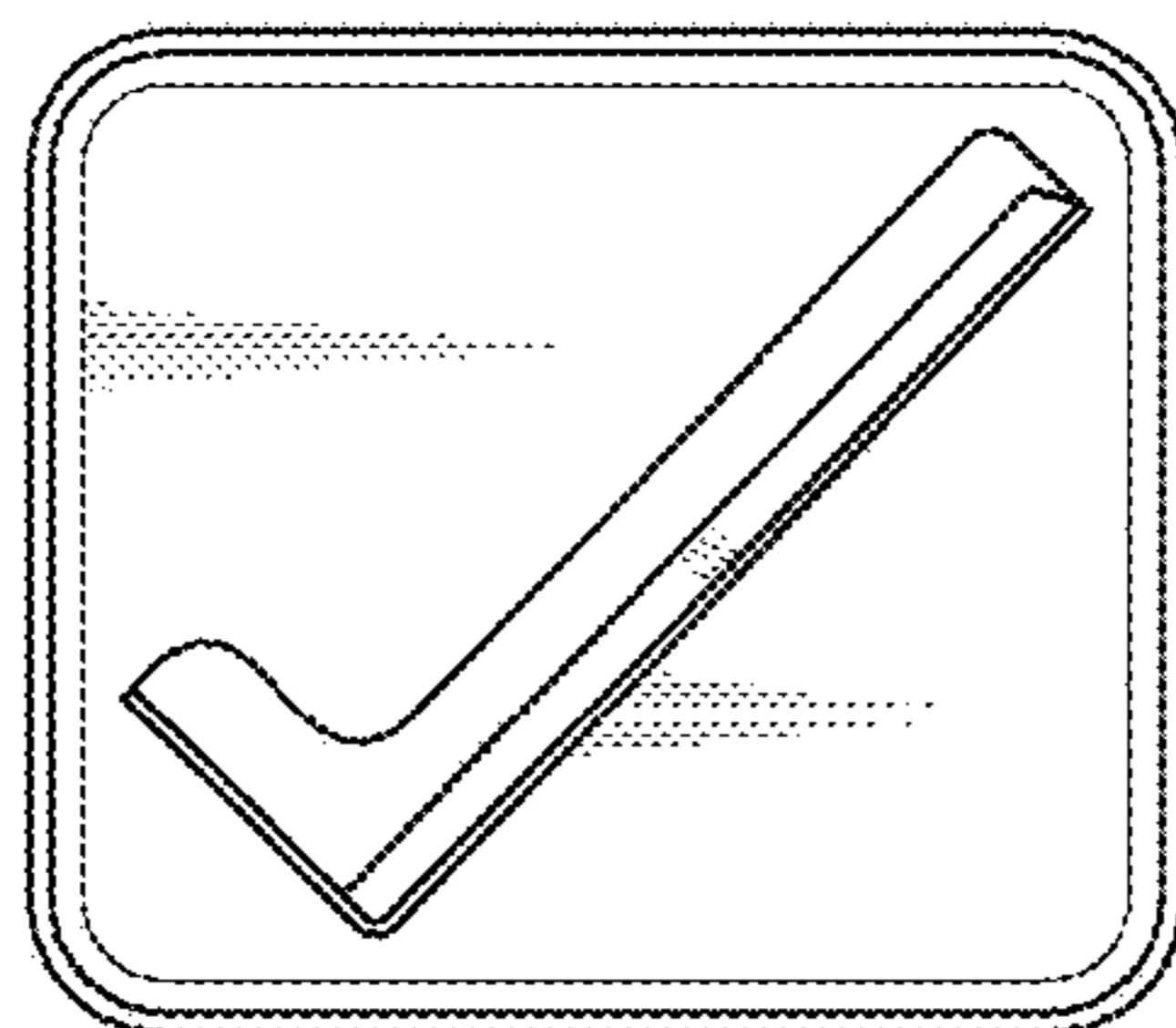

FIG. 7