



US00D859869S

(12) **United States Design Patent** (10) **Patent No.:** **US D859,869 S**
Lievore et al. (45) **Date of Patent:** **** Sep. 17, 2019**

(54) **ARMCHAIR**

(56) **References Cited**

(71) Applicant: **ARPER S.P.A.**, Monastier di Treviso (IT)

U.S. PATENT DOCUMENTS

(72) Inventors: **Alberto Lievore**, Treviso (IT);
Jeannette Altherr, Treviso (IT)

D205,939 S *	10/1966	Laverne et al.	D6/375
3,281,185 A *	10/1966	Albinson	A47C 5/12
			297/218.5
3,999,802 A *	12/1976	Powers	A47C 3/04
			297/447.3
D393,956 S *	5/1998	Kane	D6/334
D564,248 S *	3/2008	Alter Molina	D6/373
D746,609 S *	1/2016	Lievore	A47C 5/12
			D6/375
9,398,811 B1 *	7/2016	Williams	A47C 3/12
D766,640 S *	9/2016	Kubryk	D6/716
D802,321 S *	11/2017	Martinez	D6/373
D811,757 S *	3/2018	Moscheri	A47C 3/04
			D6/334
D814,814 S *	4/2018	Spoelhof	D6/349
D825,215 S *	8/2018	Olofsson	D6/373

(73) Assignee: **ARPER S.P.A.**, Monastier di Treviso (IT)

(**) Term: **15 Years**

(21) Appl. No.: **35/503,898**

(22) Filed: **Aug. 29, 2017**

(80) **Hague Agreement Data**

Int. Filing Date: **Aug. 29, 2017**

Int. Reg. No.: **DM/098141**

Int. Reg. Date: **Aug. 29, 2017**

Int. Reg. Pub. Date: **Nov. 3, 2017**

(30) **Foreign Application Priority Data**

Mar. 31, 2017 (WO) DM/096824

(51) **LOC (12) Cl.** **06-01**

(52) **U.S. Cl.**
USPC **D6/375; D6/374**

(58) **Field of Classification Search**
USPC D6/334, 360, 369-377
CPC A47C 3/00; A47C 4/00; A47C 4/02; A47C
5/00; A47C 5/04; A47C 5/12; A47C 7/00;
A47C 7/002; A47C 7/004; A47C 7/006
See application file for complete search history.

* cited by examiner

Primary Examiner — Mary Ann Calabrese
(74) *Attorney, Agent, or Firm* — Thomas|Horstemeyer, LLP

(57) **CLAIM**

The ornamental design for an armchair, as shown and described.

DESCRIPTION

1. Armchair
1.1 is a perspective view; 1.2 is a right side view; 1.3 is a left side view; 1.4 is a front view; 1.5 is a rear view; 1.6 is a top view; 1.7 is a bottom view.
The broken lines shown in the drawings of the armchair are for the purposes of illustrating the environment and form no part of the claimed design.

1 Claim, 7 Drawing Sheets

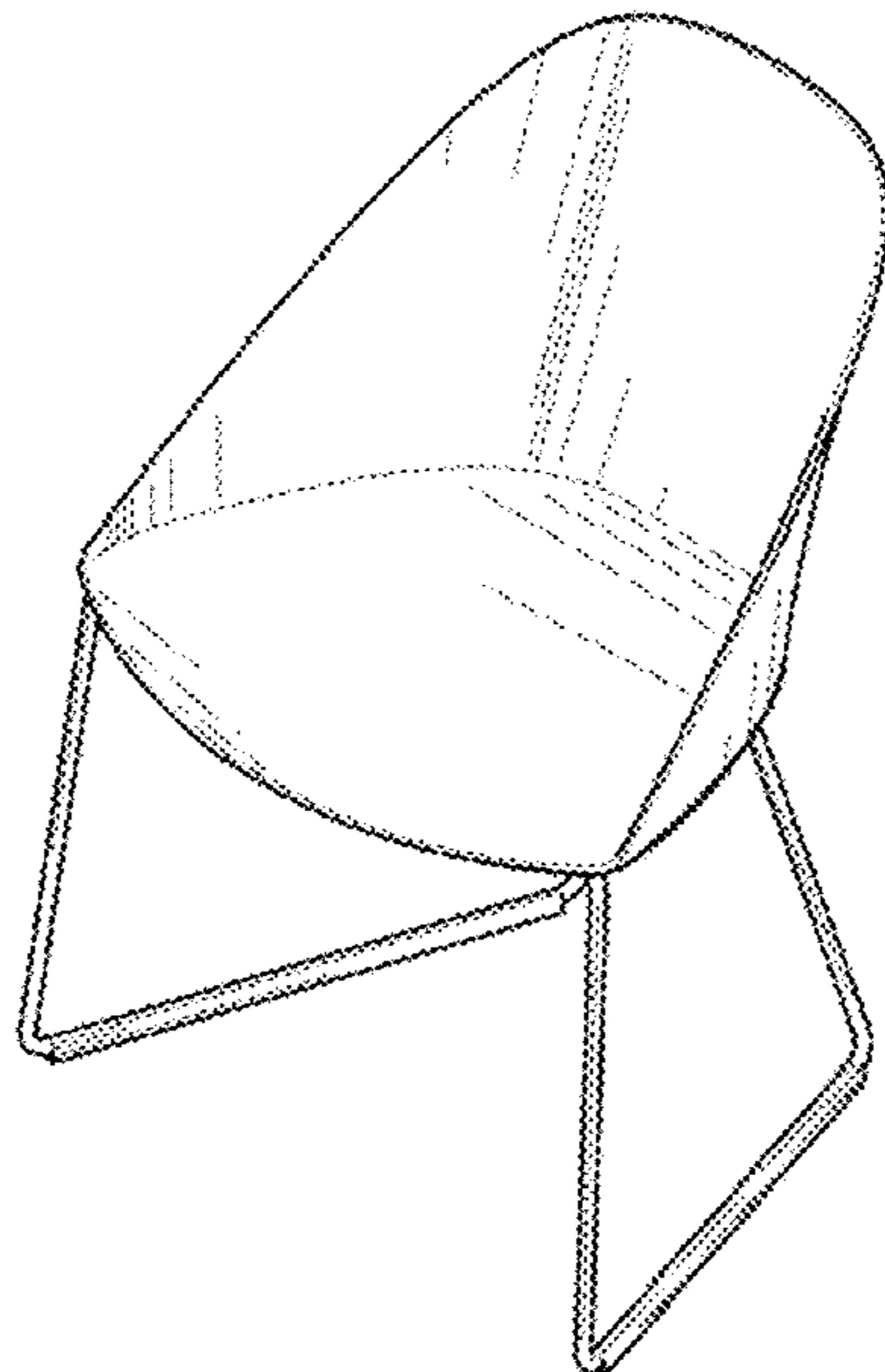

1.1

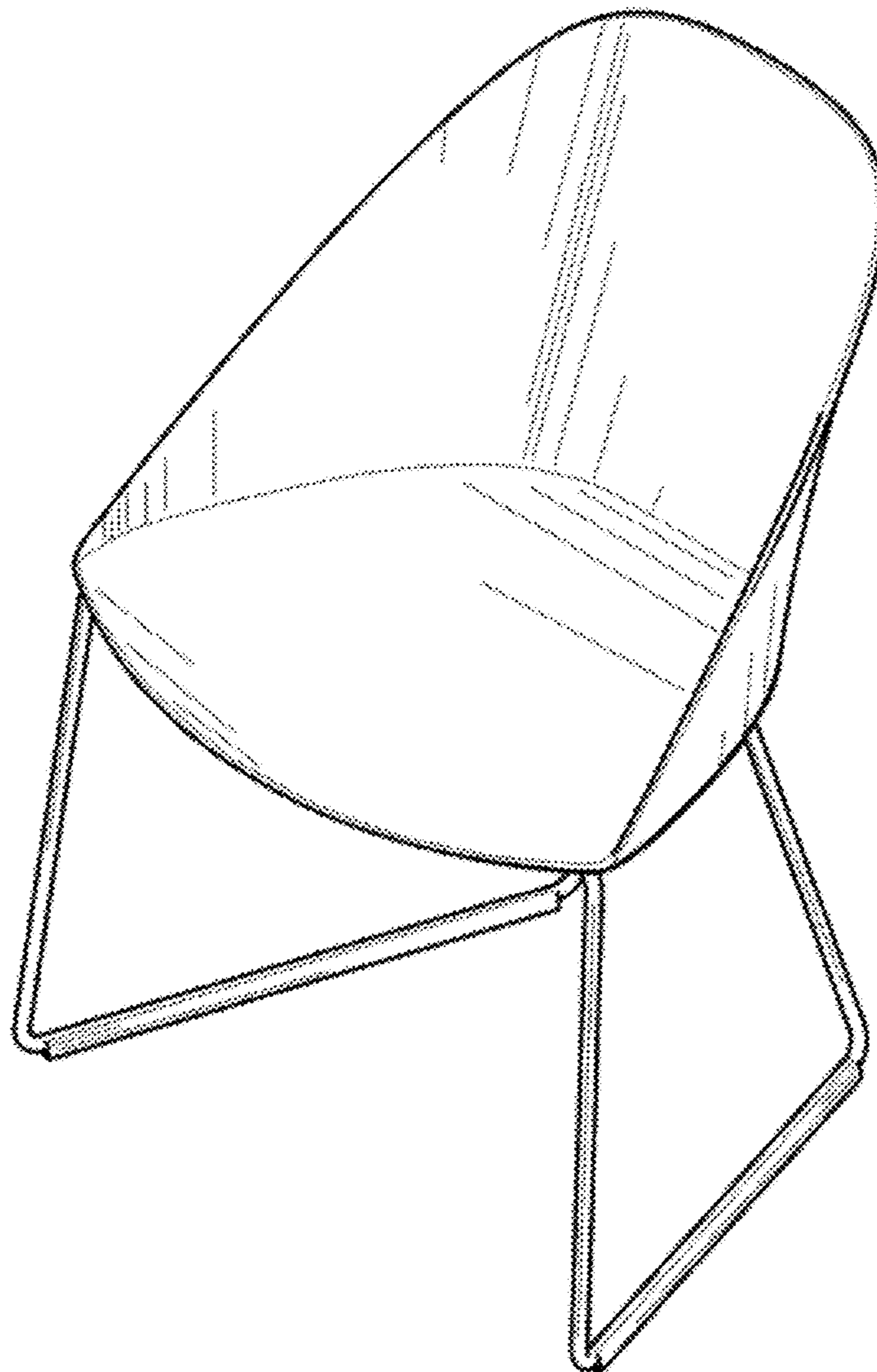

1.2

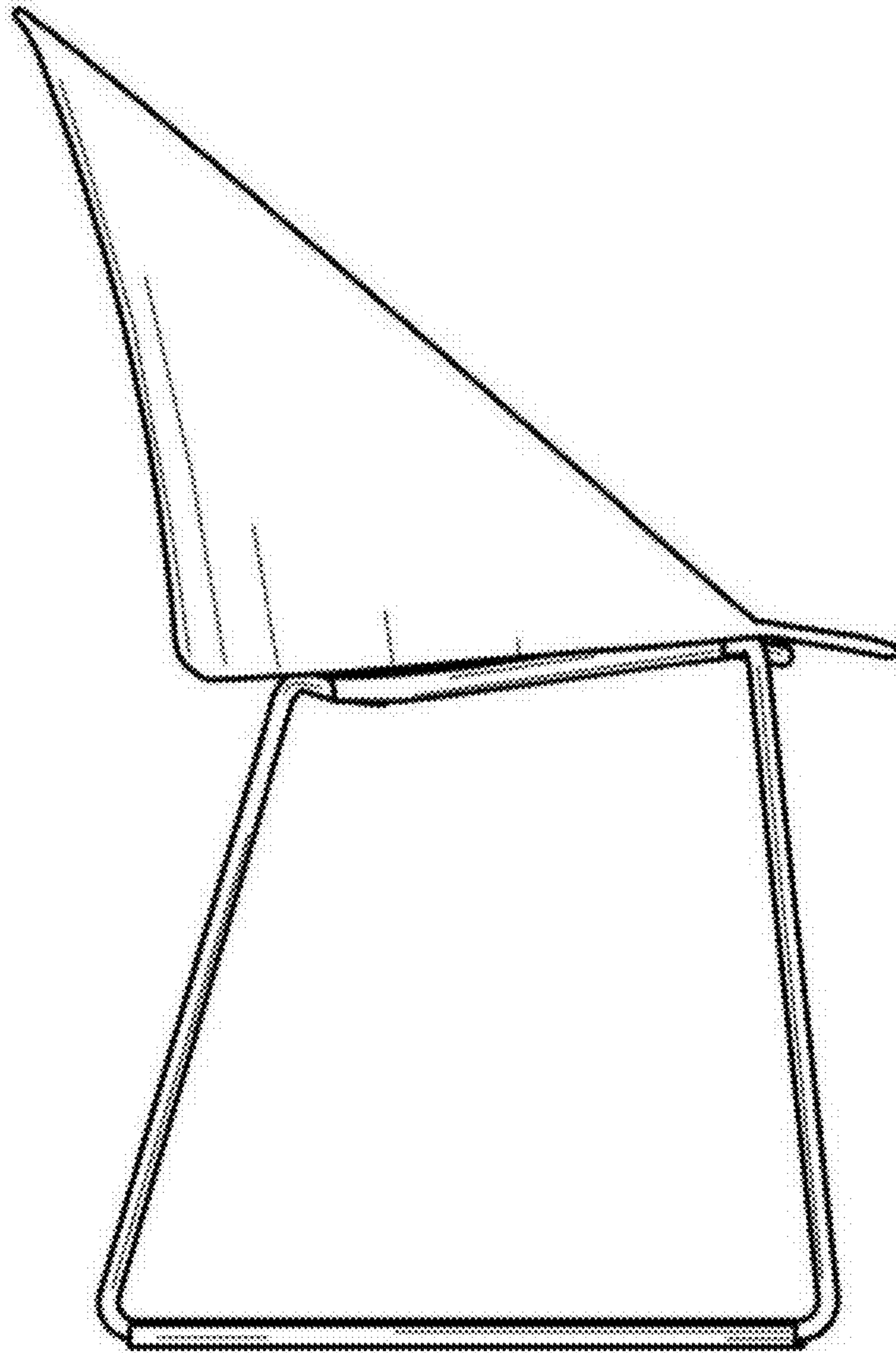

1.3

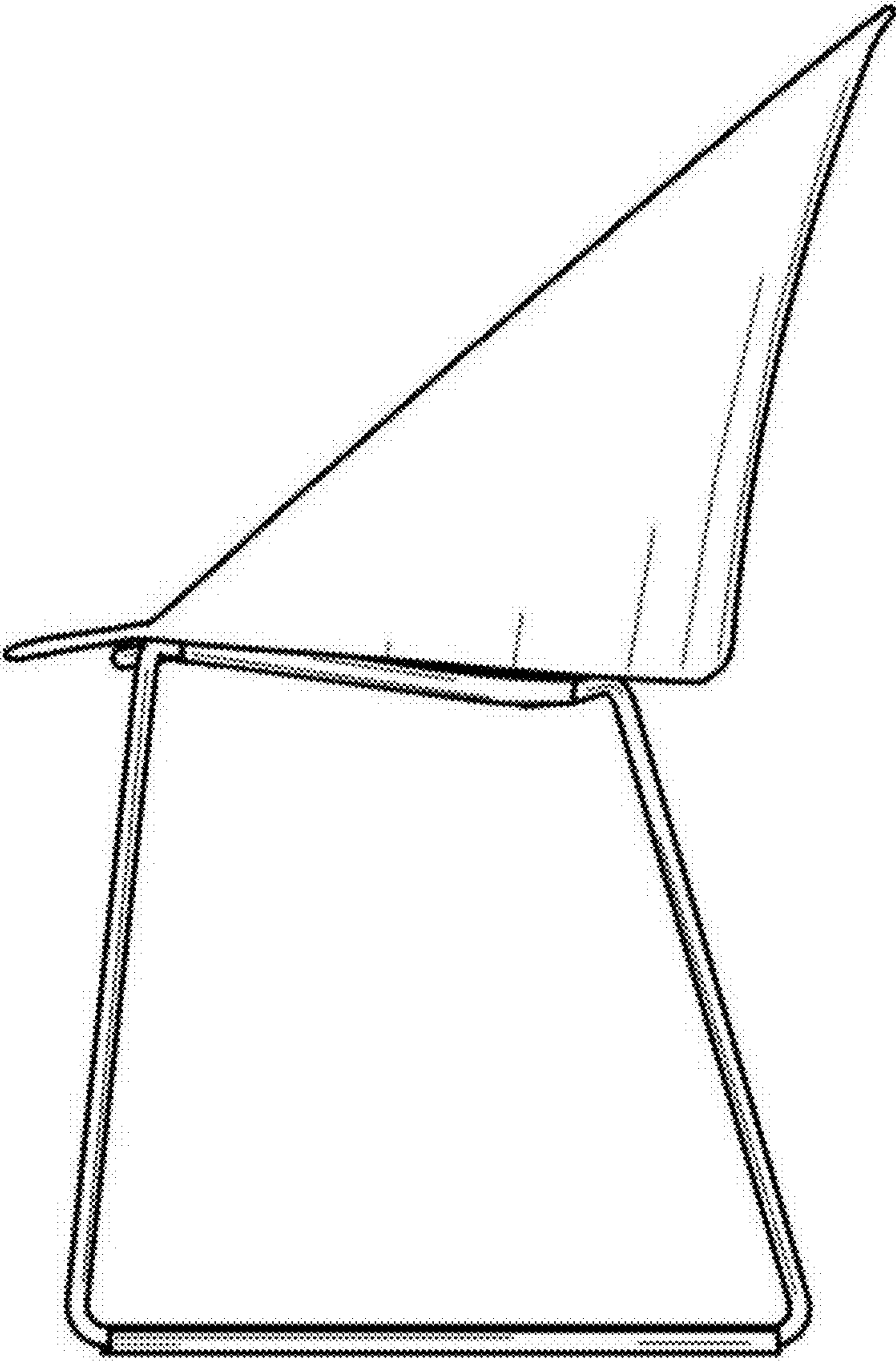

1.4

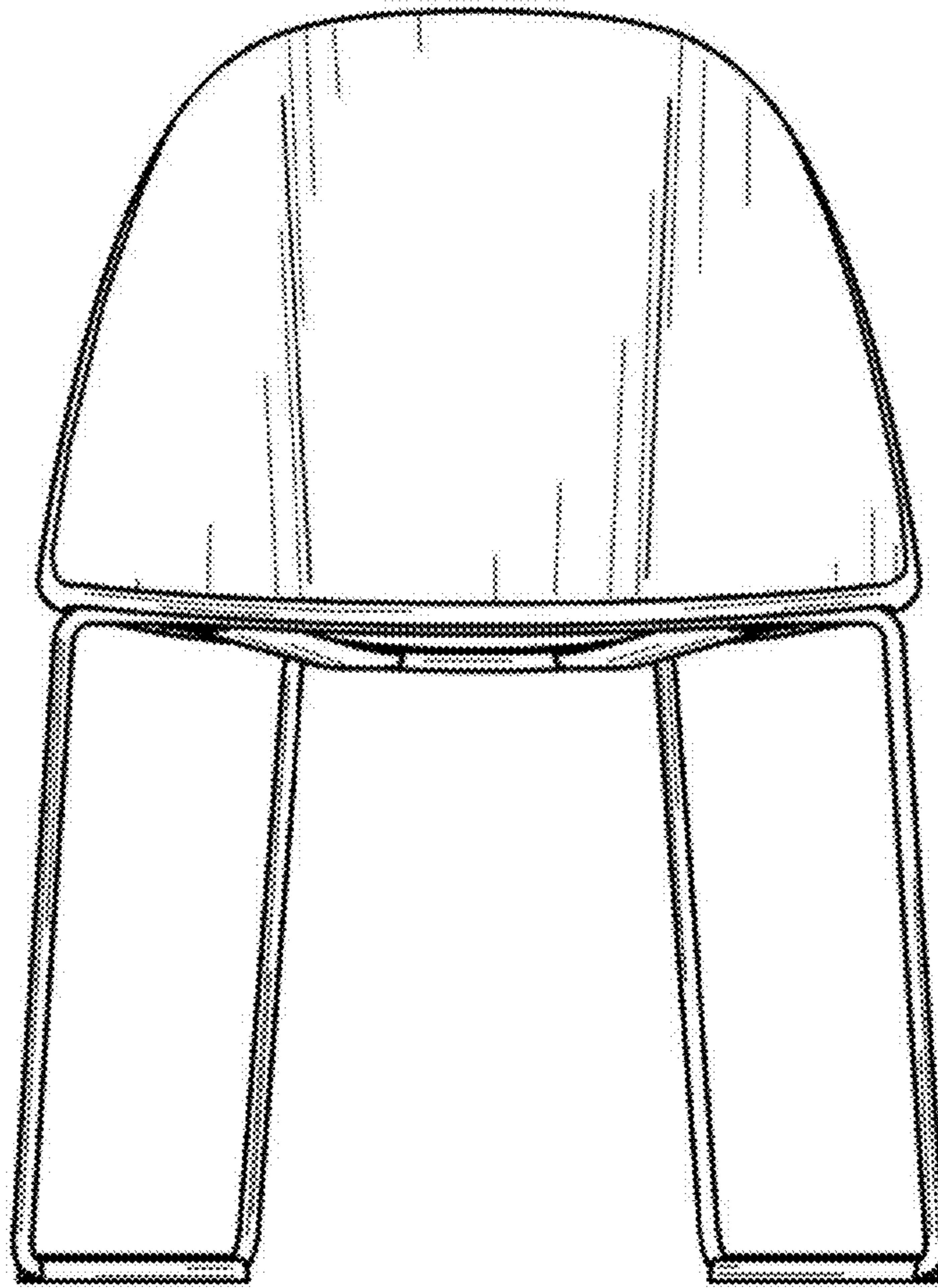

1.5

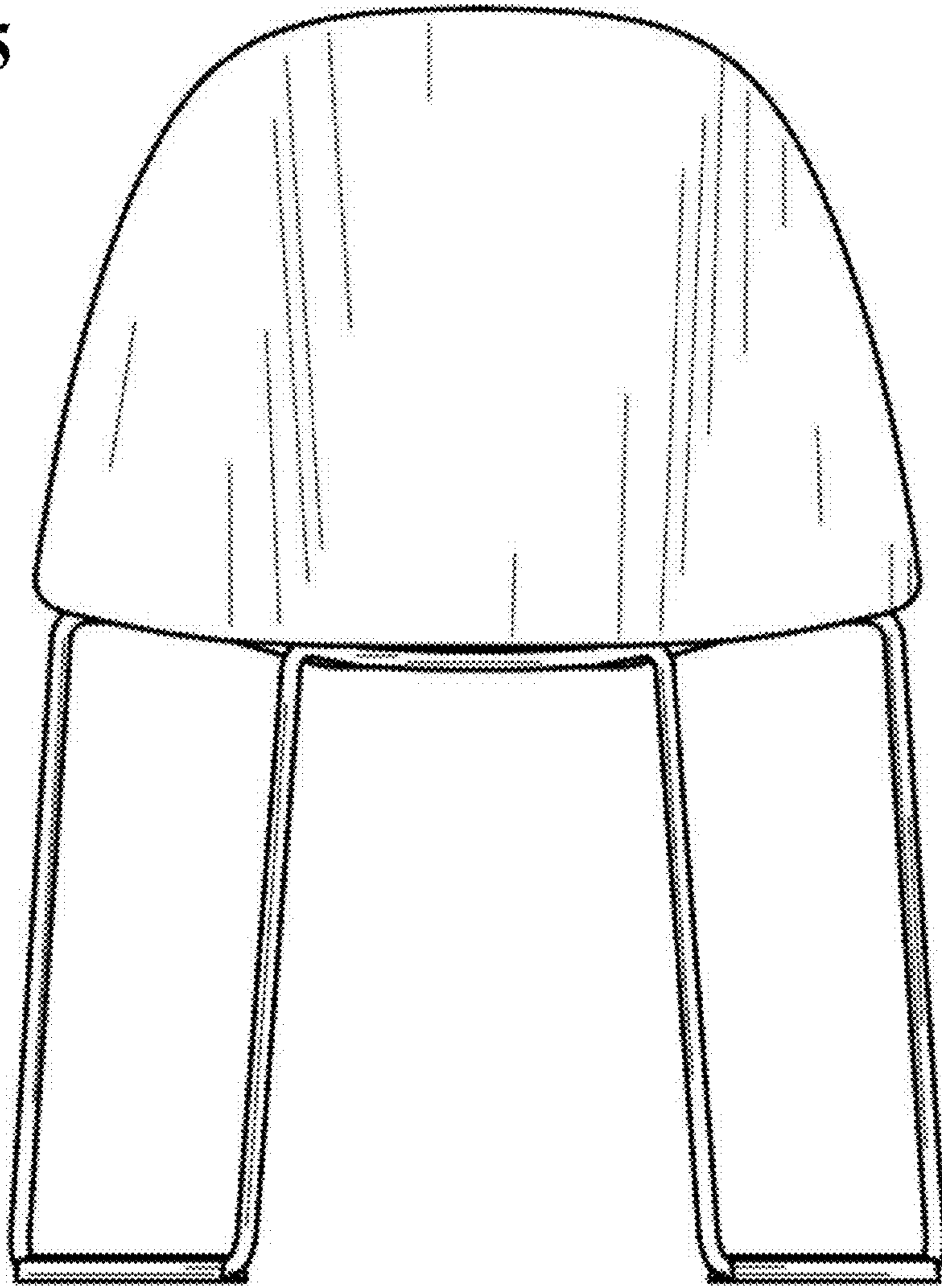

1.6

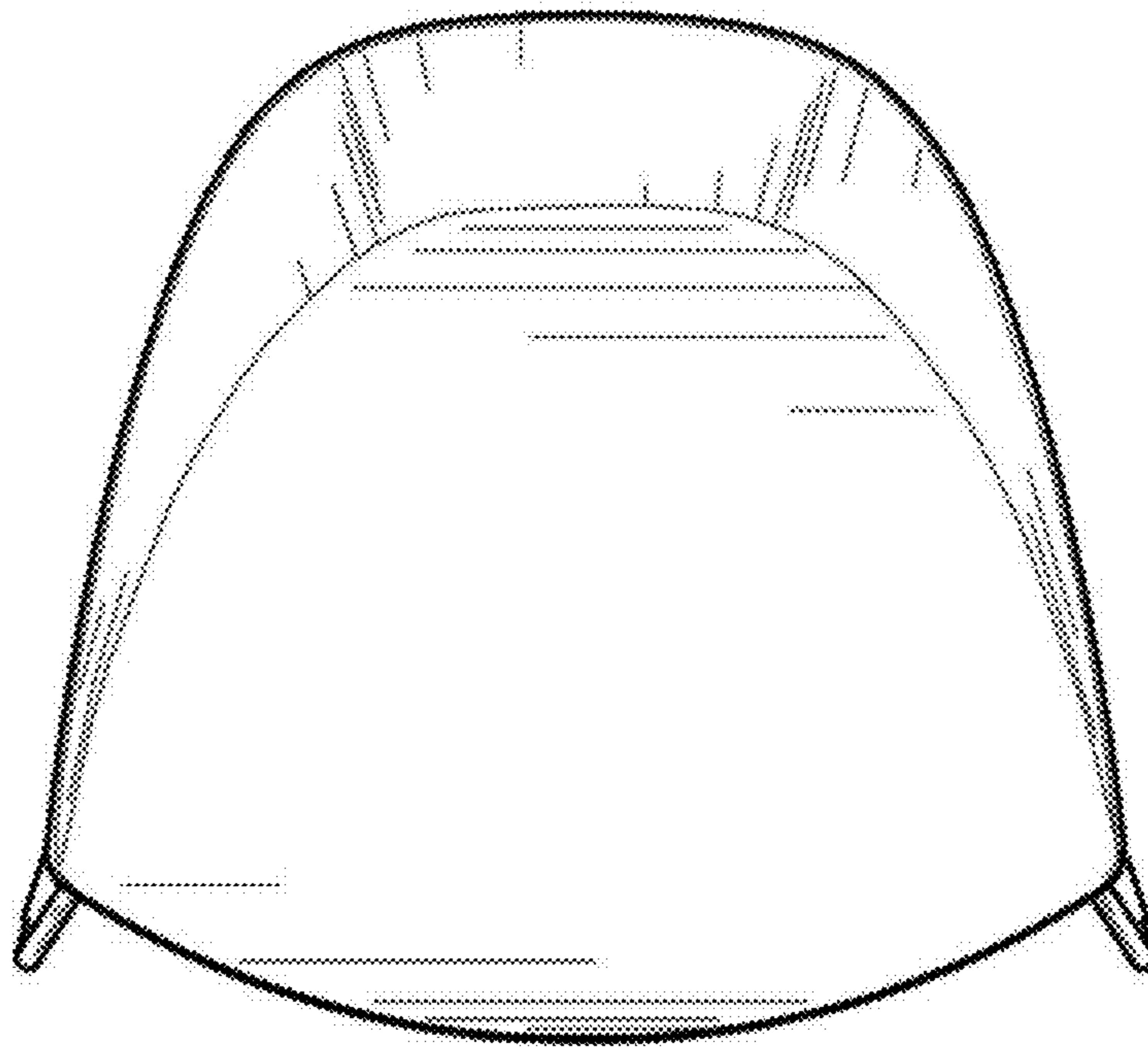

1.7

