



US00D859841S

(12) **United States Design Patent**  
**Zhong**

(10) **Patent No.:** **US D859,841 S**

(45) **Date of Patent:** **\*\* Sep. 17, 2019**

- (54) **STRAP**
- (71) Applicant: **Shenzhen Shengyoutiandi Technology Co., Ltd.**, Shenzhen, Guangdong (CN)
- (72) Inventor: **Yuyue Zhong**, Guangdong (CN)
- (73) Assignee: **Shenzhen ShengYouTianDi technology co., LTD**, Shenzhen (CN)

(\*\*) Term: **15 Years**

(21) Appl. No.: **29/613,105**

(22) Filed: **Aug. 7, 2017**

(51) **LOC (12) Cl.** ..... **03-01**

(52) **U.S. Cl.**  
USPC ..... **D3/327**

(58) **Field of Classification Search**  
CPC ..... A45F 3/04; A45F 3/14; A45F 3/02; A45C 3/00; A45C 9/00; A45C 13/30  
See application file for complete search history.

(56) **References Cited**

U.S. PATENT DOCUMENTS

- 4,127,223 A \* 11/1978 Uchin ..... A45F 5/00  
224/250
- D386,125 S \* 11/1997 Anscher ..... D11/200
- D386,310 S \* 11/1997 Smith ..... D3/327
- D420,514 S \* 2/2000 Morlet ..... D3/327
- 6,390,345 B1 \* 5/2002 Brown ..... A45C 3/00  
190/110
- D488,922 S \* 4/2004 Refsum ..... D3/213
- D609,011 S \* 2/2010 Cucuzza ..... A45F 5/12  
D3/327
- D617,561 S \* 6/2010 Salerno-Tortora ..... D3/318

- D623,861 S \* 9/2010 Kope ..... G03B 17/566  
D3/327
- D691,809 S \* 10/2013 Palevac ..... D3/327
- D732,295 S \* 6/2015 Aafjes ..... D3/318
- D793,089 S \* 8/2017 Jackson ..... D3/327
- D815,433 S \* 4/2018 Gerbelle ..... D3/246
- D836,334 S \* 12/2018 Chung ..... A45C 3/06  
D3/243
- D841,985 S \* 3/2019 Venturini Fendi ..... D3/327

\* cited by examiner

*Primary Examiner* — Holly H Baynham

(74) *Attorney, Agent, or Firm* — ScienBiziP, P.C.

(57) **CLAIM**

The ornamental design for a strap, as shown and described.

**DESCRIPTION**

FIG. 1 is a first perspective view of a strap showing my new design;

FIG. 2 is a second perspective view thereof;

FIG. 3 is a front elevational view thereof;

FIG. 4 is a rear elevational view thereof;

FIG. 5 is a left side view thereof;

FIG. 6 is a right side view thereof;

FIG. 7 is a top plan view thereof;

FIG. 8 is a bottom plan view thereof;

FIG. 9 is an enlarged view of portion 9 of FIG. 7; and,

FIG. 10 is a perspective view showing the strap in a use state.

The broken lines in the drawings illustrate portions of the strap which form no part of the claimed design.

The broken lines in FIG. 10 depicting a person and a camera also form no part of the claimed design.

**1 Claim, 10 Drawing Sheets**

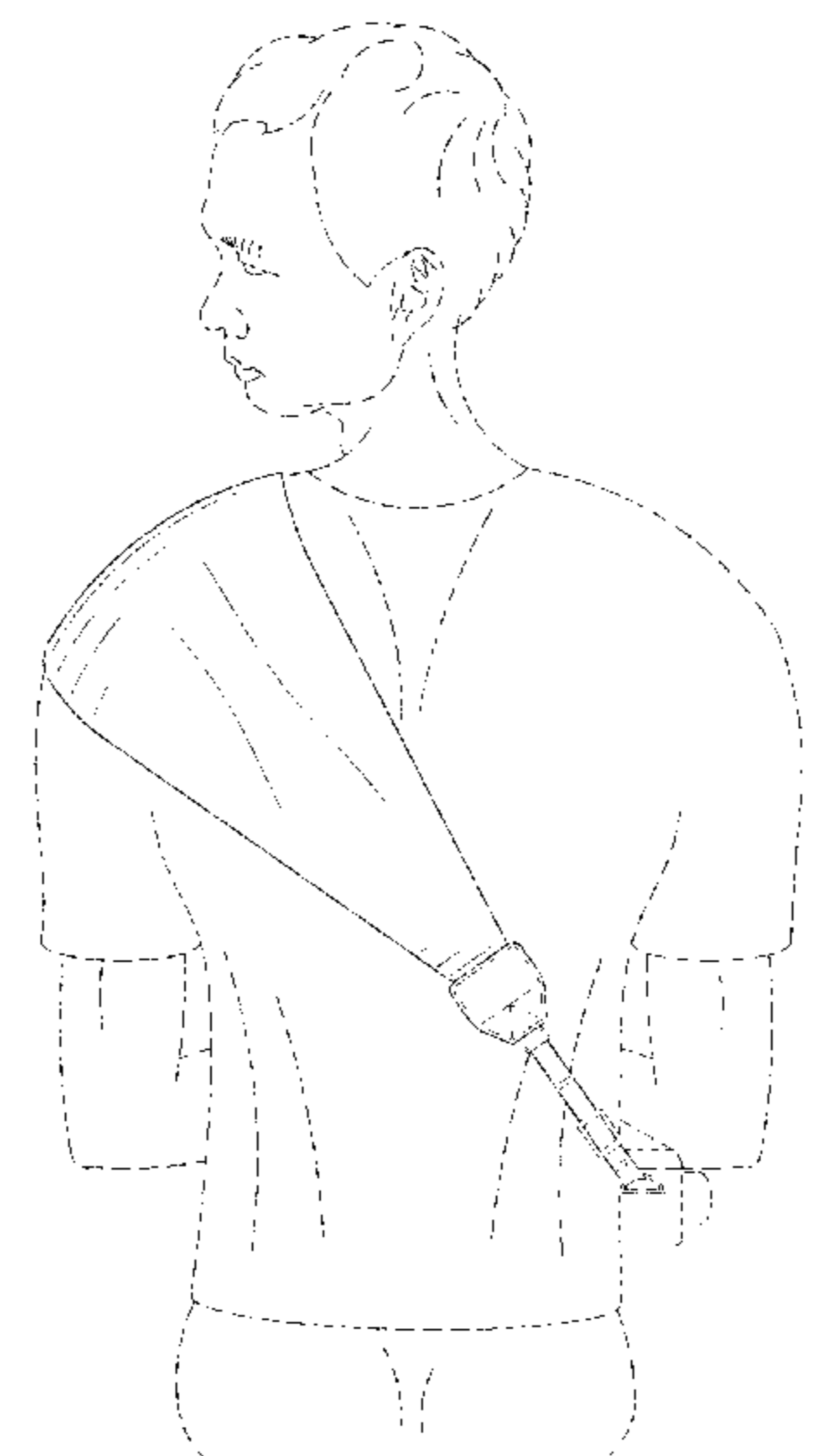
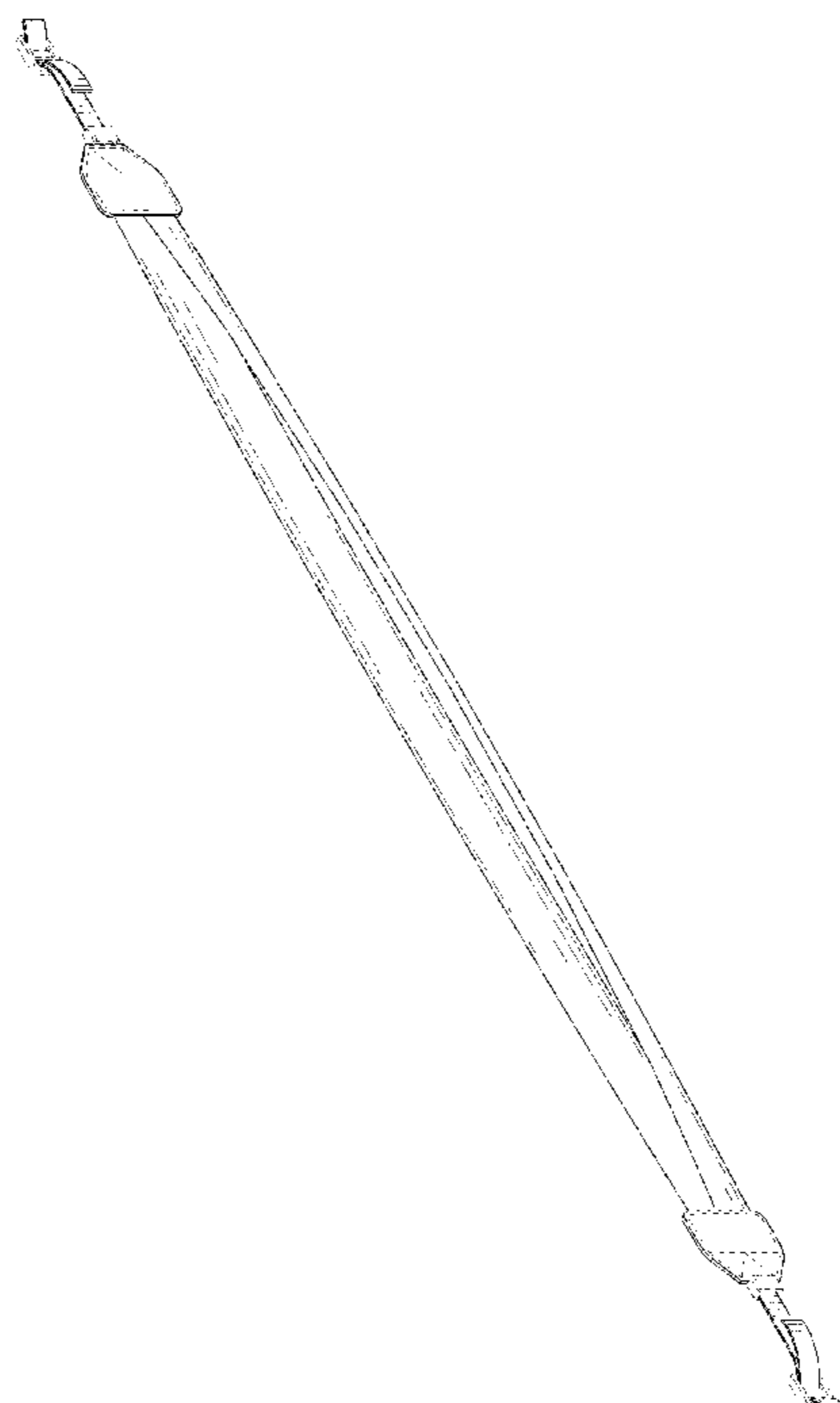

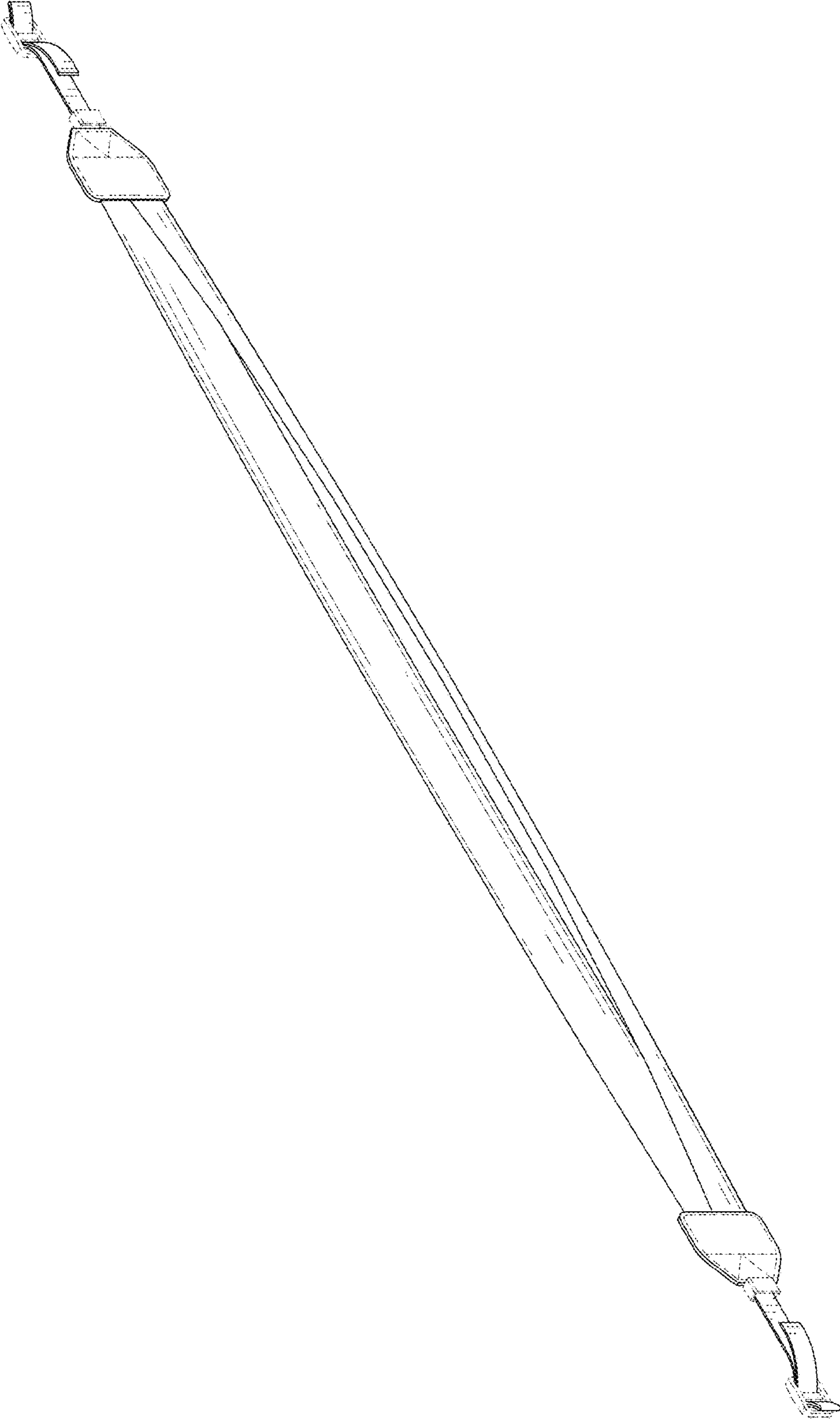

Fig. 1

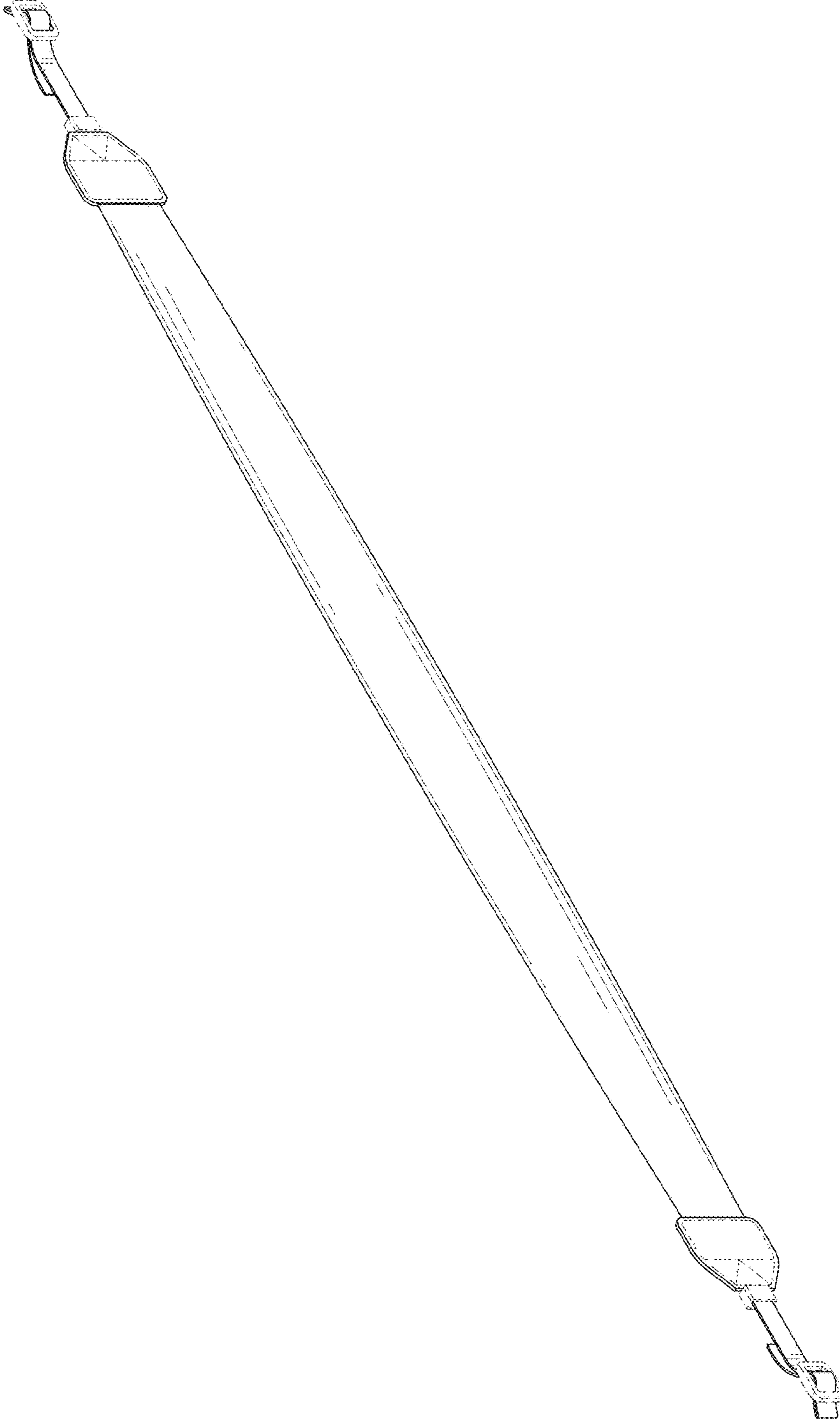

Fig. 2

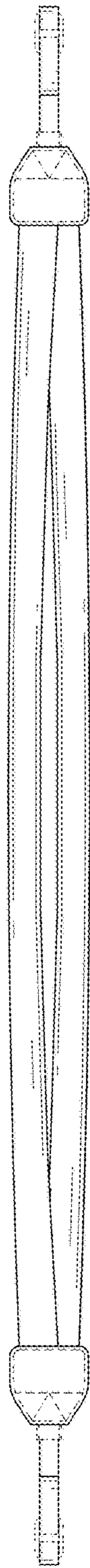

Fig. 3

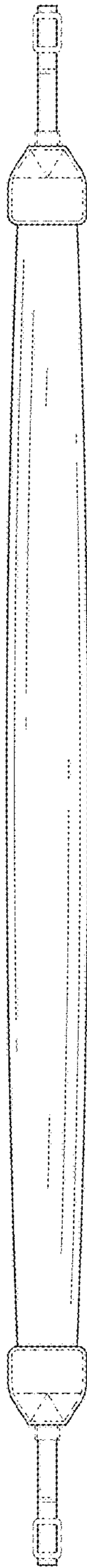

Fig. 4

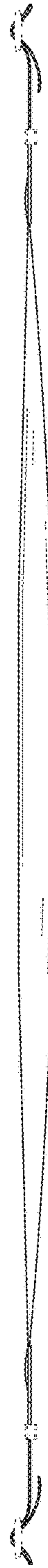

Fig. 5

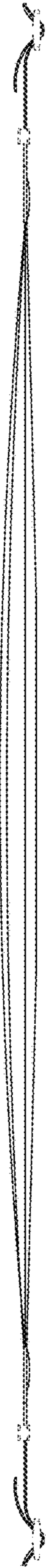

Fig. 6

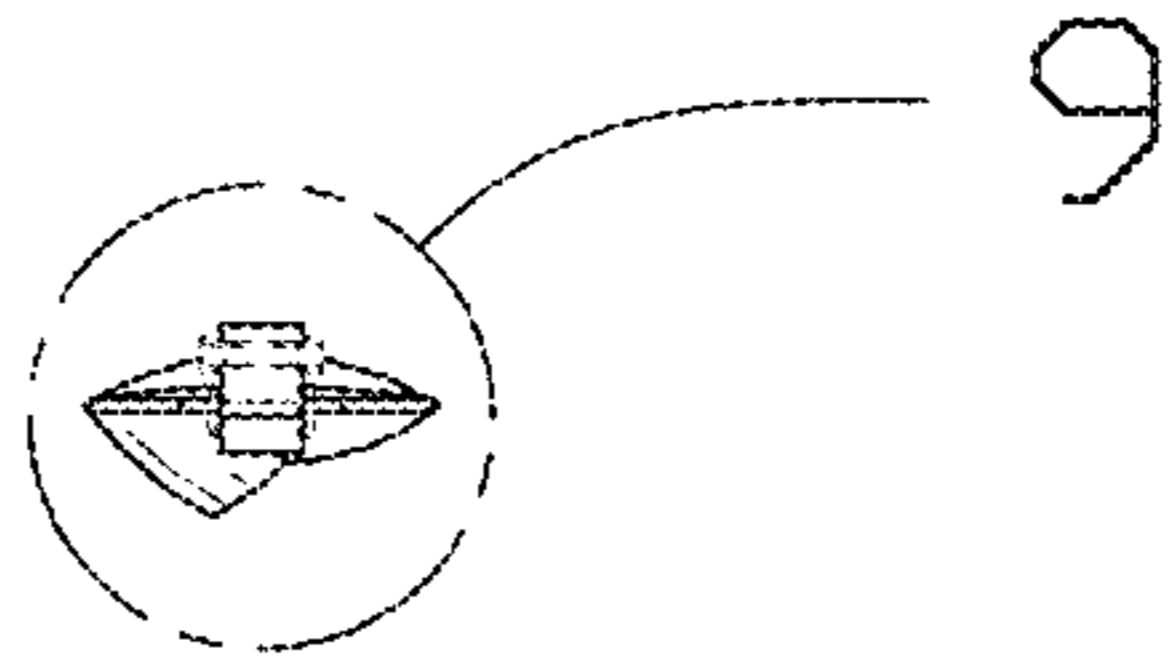

Fig. 7





Fig. 8

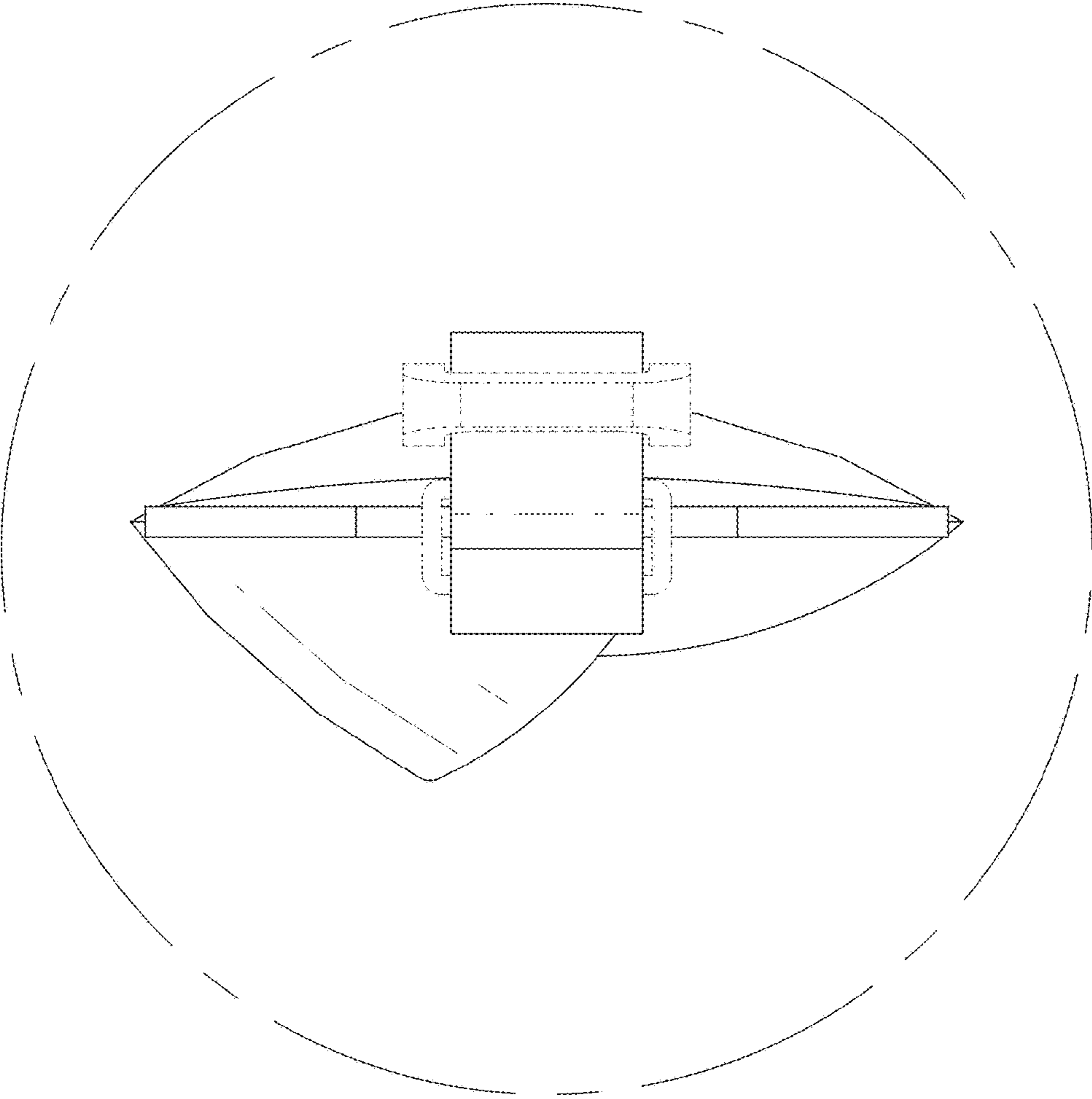

Fig. 9

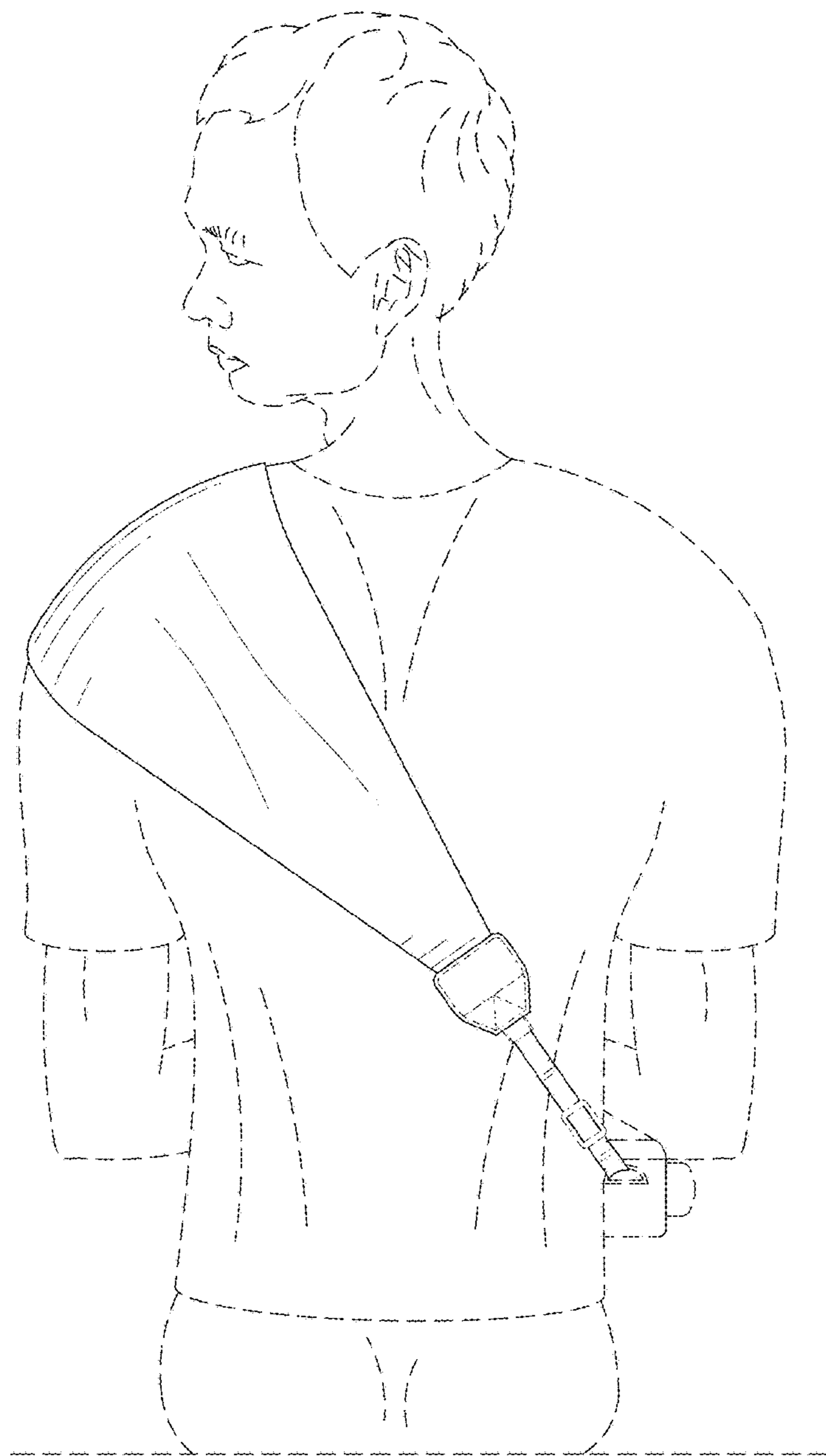

Fig. 10