



US00D859817S

(12) **United States Design Patent** (10) **Patent No.:** **US D859,817 S**  
**Chiesa et al.** (45) **Date of Patent:** **\*\* Sep. 17, 2019**

(54) **NEONATE MEDICAL WRAP** 4,987,612 A \* 1/1991 Middleton ..... A41D 1/215  
2/104  
(71) Applicant: **Saplacor, LLC**, La Jolla, CA (US) 5,224,637 A \* 7/1993 Colombo ..... A47D 13/025  
224/158  
(72) Inventors: **Mary Chiesa**, Brentwood, CA (US); 5,632,425 A \* 5/1997 Hull ..... A47D 13/025  
2/111  
**Laney Chiesa**, Los Angeles, CA (US); 5,946,725 A \* 9/1999 Shatzkin ..... A41D 1/215  
2/106  
**Carin Johnson**, Los Angeles, CA (US); 6,065,655 A 5/2000 Parewick  
**Kailey Watson**, Los Angeles, CA (US) 6,343,727 B1 \* 2/2002 Leach ..... A47D 13/02  
2/102  
(\*\*) Term: **15 Years**

(Continued)

(21) Appl. No.: **29/626,905**

(22) Filed: **Nov. 21, 2017**

FOREIGN PATENT DOCUMENTS

CN 202588350 U 3/2012  
CN 204379553 U 12/2014

**Related U.S. Application Data**

(63) Continuation of application No. 15/591,802, filed on May 10, 2017.

(51) **LOC (12) Cl.** ..... **03-99**

(52) **U.S. Cl.**  
USPC ..... **D3/214**

(58) **Field of Classification Search**  
USPC ..... D3/213, 214, 215, 216  
CPC ..... A47D 13/02; A47D 13/025; A45F 3/04;  
A45F 4/02; A45F 2200/0525; A45F  
2003/045  
See application file for complete search history.

*Primary Examiner* — John Windmuller

*Assistant Examiner* — Steven J Czyz

(74) *Attorney, Agent, or Firm* — Buche & Associates, P.C.; John K. Buche; Bryce A. Johnson

(57) **CLAIM**

We claim the ornamental design for a neonate medical wrap, as shown and described.

**DESCRIPTION**

FIG. 1. is a perspective view of a neonate medical wrap;  
FIG. 2. Is a front view thereof;  
FIG. 3. Is a rear view thereof;  
FIG. 4. Is a right-side view thereof;  
FIG. 5. Is a left-side view thereof;  
FIG. 6. Is a top view thereof;  
FIG. 7. Is a bottom view thereof; and,  
FIG. 8. Is a perspective view of the neonate medical wrap, shown in use.

The broken lines depict environment that forms no part of the claimed design.

The depicted neonate medical wrap features a novel and unique appearance over the prior art.

(56) **References Cited**

U.S. PATENT DOCUMENTS

2,237 A 9/1841 Cook  
336,413 A 2/1886 Karp  
3,229,873 A \* 1/1966 Hershman ..... A47D 13/025  
224/160  
3,443,066 A 5/1969 Weibel  
4,079,467 A 3/1978 Baldwin  
4,089,067 A 5/1978 Valesco  
4,166,558 A \* 9/1979 Schroeder ..... A47D 13/025  
224/158  
4,773,102 A 9/1988 Curtis et al.

**1 Claim, 4 Drawing Sheets**

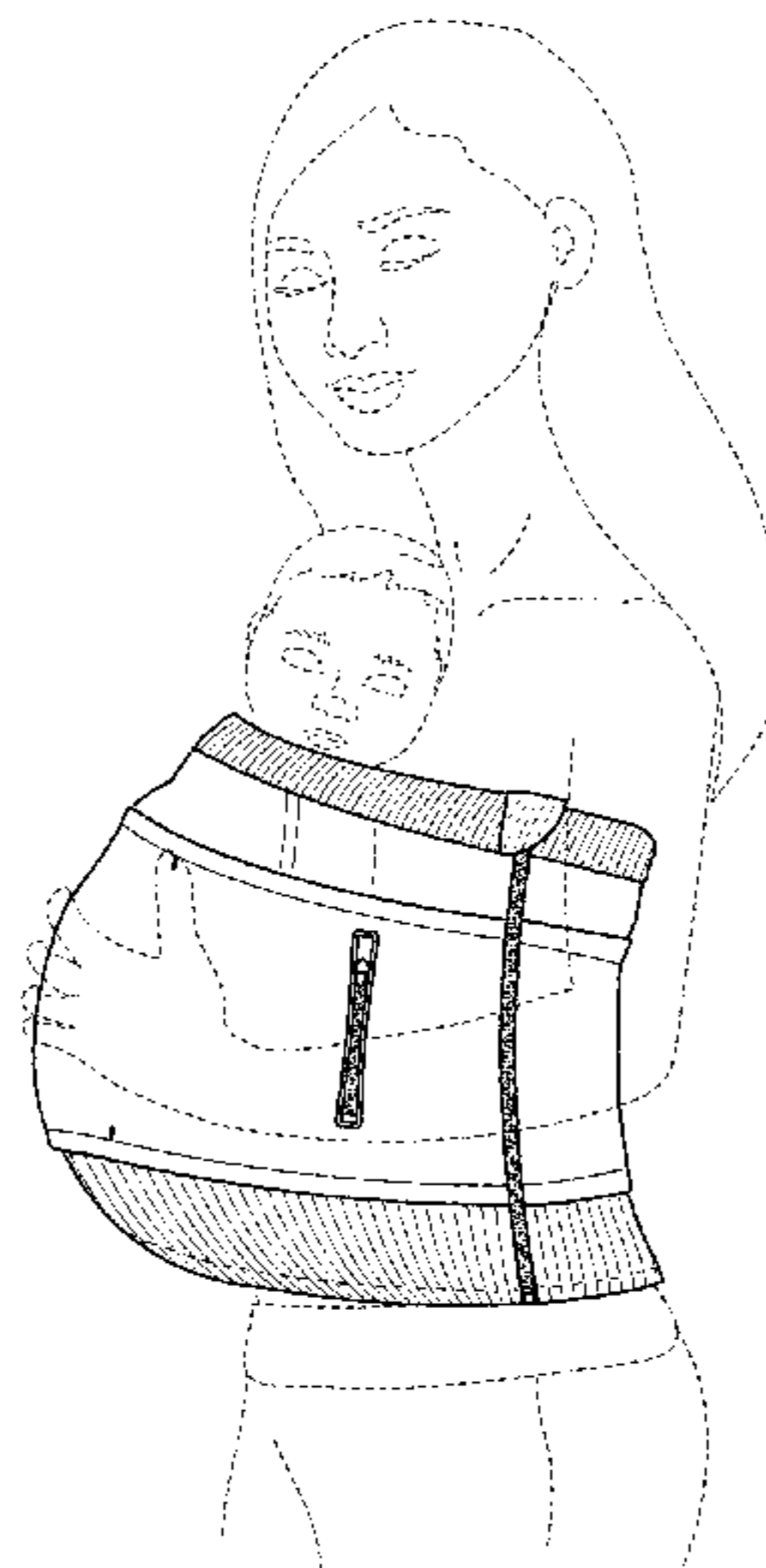

(56)

**References Cited**

U.S. PATENT DOCUMENTS

6,434,750 B1 *	8/2002	Hunter	.....	A41B 13/00	2/104	2006/0206978 A1 *	9/2006	Hilton	.....	A41D 13/1245
6,443,885 B1 *	9/2002	Schuler	.....	A61G 11/00	600/22	2007/0062987 A1 *	3/2007	Murakami	.....	A47D 13/025
6,918,770 B2 *	7/2005	Odiwo	.....	A47D 9/04	434/262	2008/0148482 A1 *	6/2008	Gonzalez	.....	A47D 13/025
7,188,372 B2 *	3/2007	Stockard	.....	A41D 1/215	2/104	2008/0149674 A1 *	6/2008	Hiniduma-Lokuge	.....	A47D 13/025
7,260,852 B2 *	8/2007	Sheetz	.....	A41D 7/00	2/104	2009/0285872 A1	11/2009	Labelle		
D574,579 S *	8/2008	Kang	.....	D2/840		2010/0288802 A1 *	11/2010	Sakanishi	.....	A47D 13/025
D672,137 S *	12/2012	Jackson	.....	D3/214		2011/0240693 A1 *	10/2011	Parness	.....	A47D 13/025
8,491,555 B2 *	7/2013	Bracci	.....	A61F 13/15	604/385.11	2013/0291279 A1 *	11/2013	Jensen	.....	A41D 1/22
8,973,793 B2	3/2015	Aryan				2014/0166705 A1 *	6/2014	Vukovics	.....	A47D 13/02
D742,630 S *	11/2015	Mullins	.....	D3/215		2014/0283277 A1 *	9/2014	Wilhelm	.....	A41B 13/00
D808,639 S *	1/2018	Gillam	.....	D3/213		2017/0013971 A1 *	1/2017	Harris	.....	A47D 13/025
2005/0133551 A1 *	6/2005	Heidt	.....	A47D 13/025	224/160	2017/0360217 A1 *	12/2017	Simmer	.....	A41D 27/20

\* cited by examiner

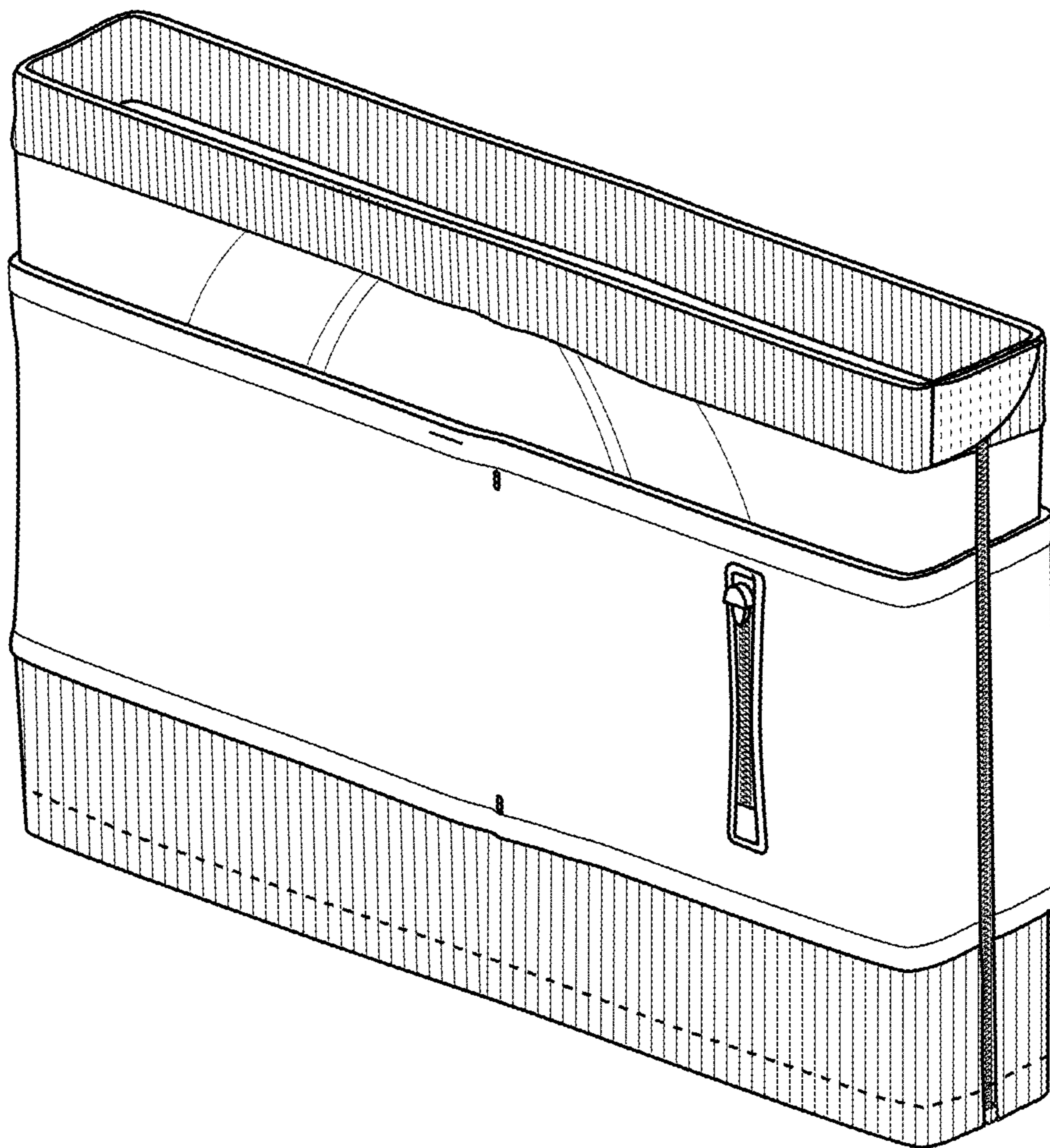

FIG. 1

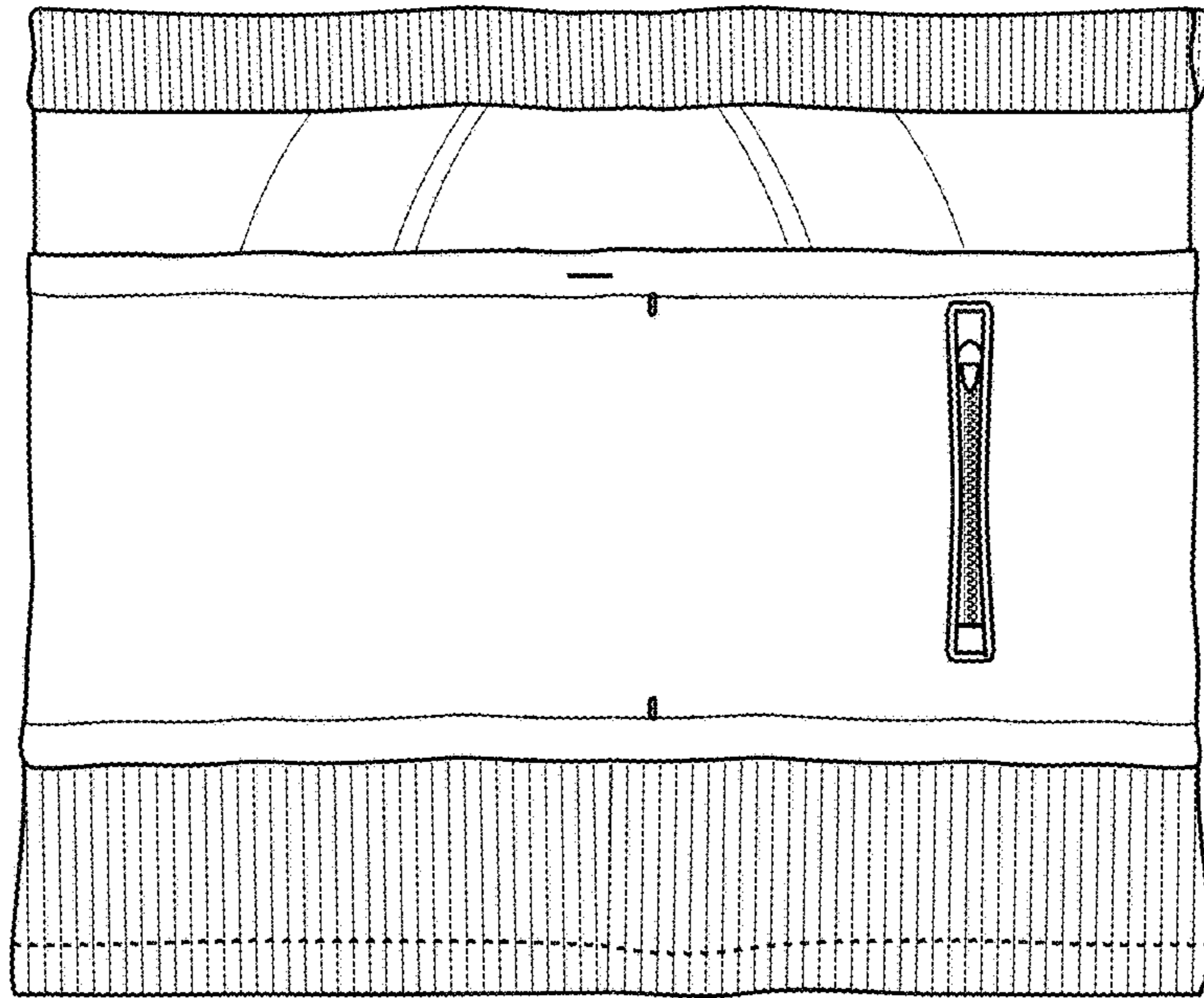

FIG. 2

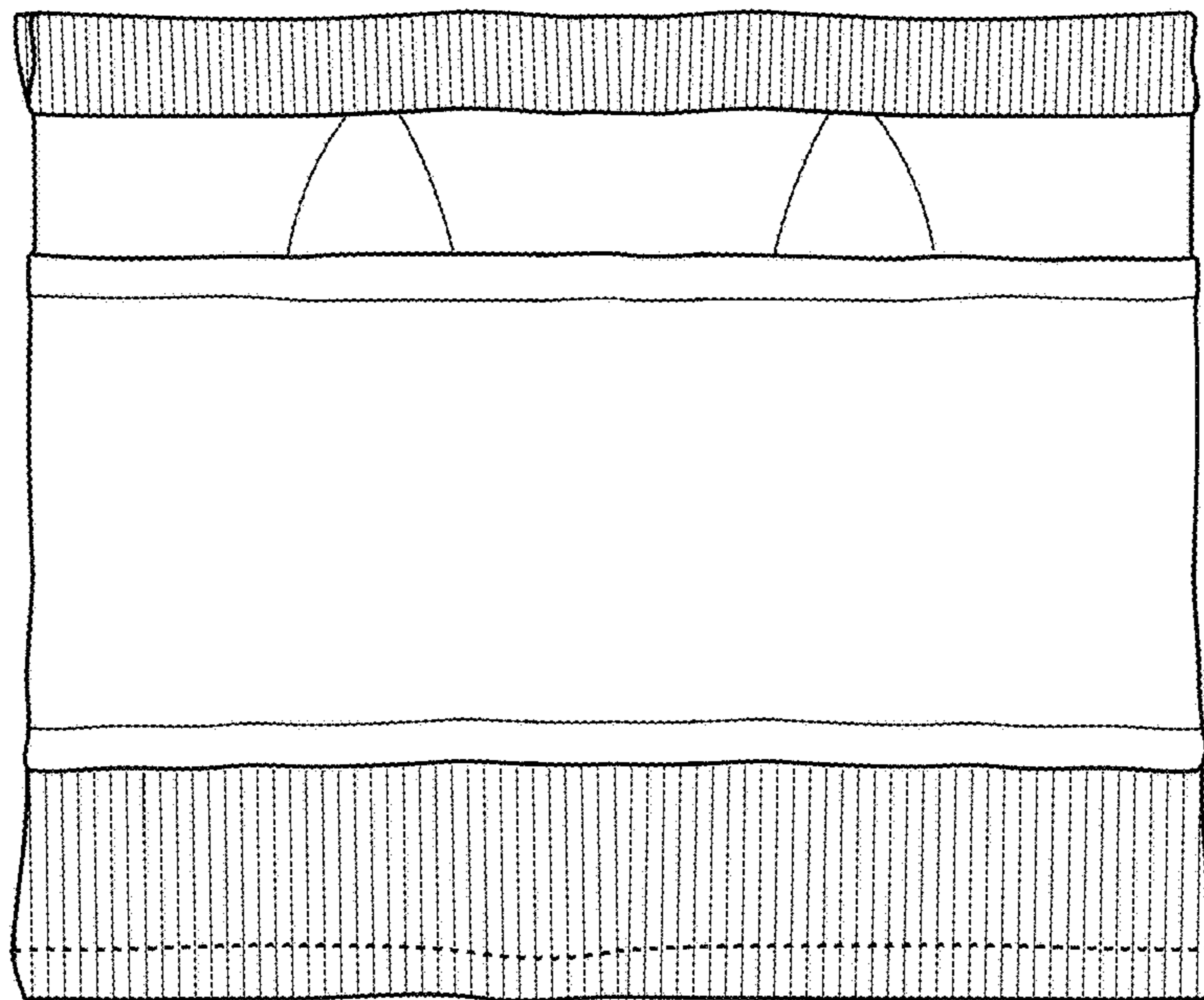

FIG. 3

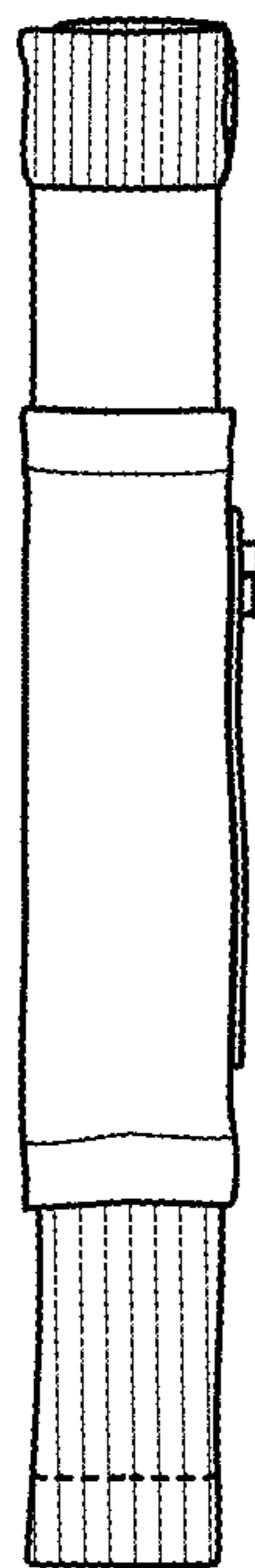

FIG. 4

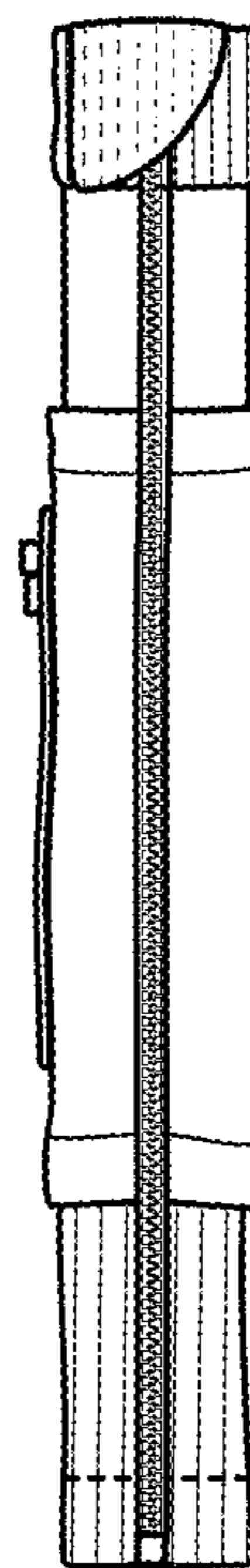

FIG. 5

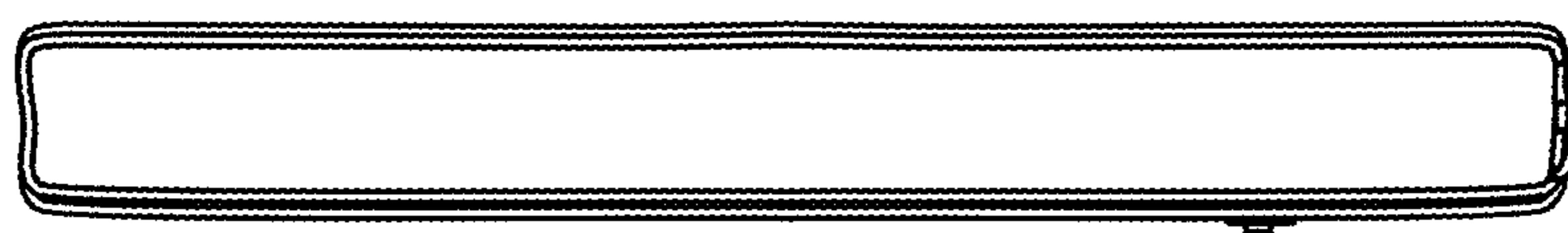

FIG. 6



FIG. 7

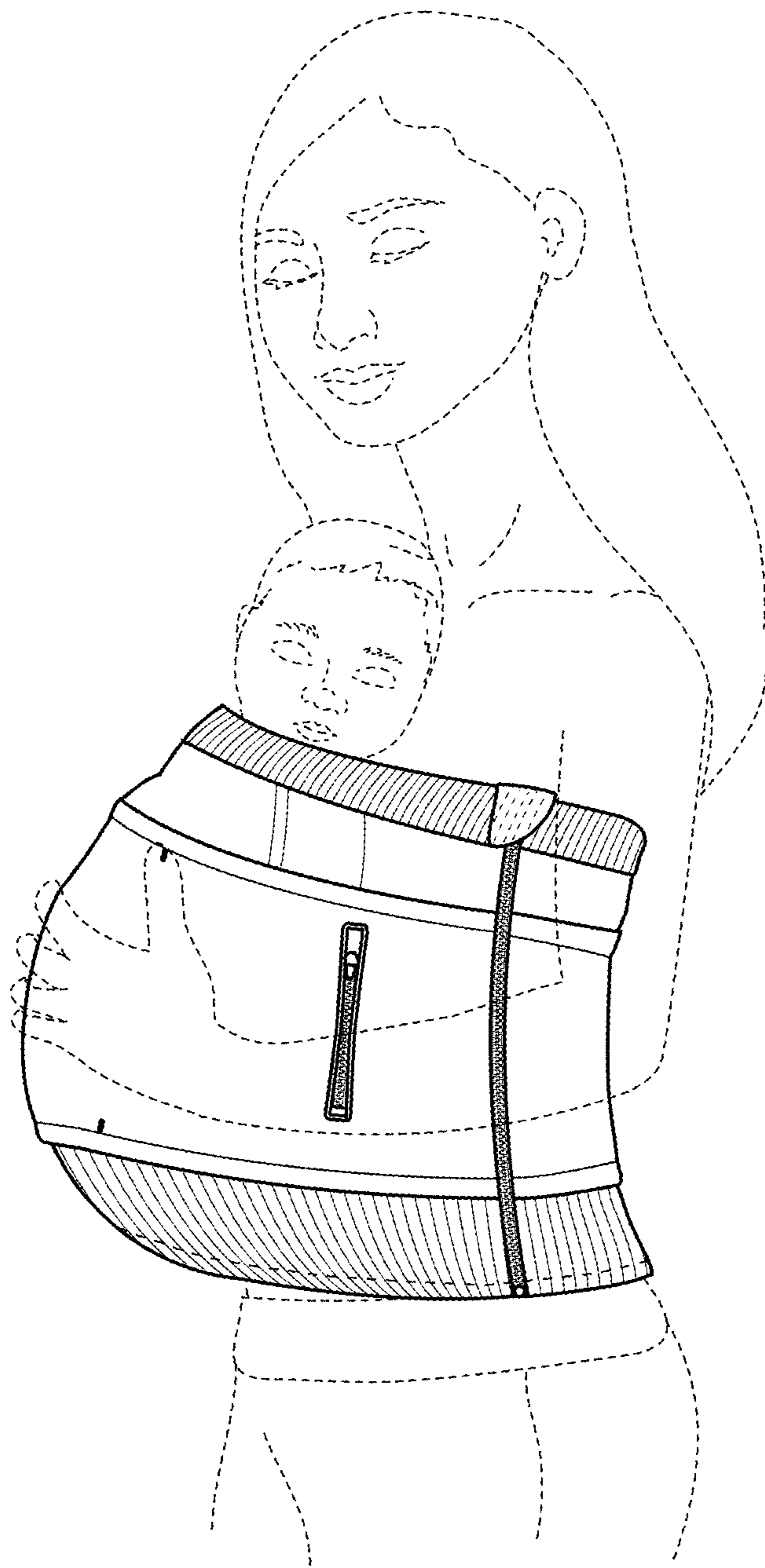

FIG. 8