



US00D859711S

(12) **United States Design Patent** (10) **Patent No.:** **US D859,711 S**
Yan (45) **Date of Patent:** **** Sep. 10, 2019**

(54) **DENTAL LED HEADLIGHT**
(71) Applicant: **Hongming Yan**, Jiangsu (CN)
(72) Inventor: **Hongming Yan**, Jiangsu (CN)
(**) Term: **15 Years**
(21) Appl. No.: **29/605,650**
(22) Filed: **May 29, 2017**
(51) **LOC (12) Cl.** **26-02**
(52) **U.S. Cl.**
USPC **D26/39**
(58) **Field of Classification Search**
USPC D26/37-51
CPC F21L 2003/00; F21L 4/00; F21L 4/005;
F21L 4/02; F21L 4/025; F21L 4/027;
F21L 4/04; F21L 4/08; F21L 2005/00;
F21L 7/00; F21L 11/00; F21L 13/00;
F21L 13/04; F21L 13/08; F21L 14/02;
F21L 17/00; F21L 19/00; F21L 25/00
See application file for complete search history.

(56) **References Cited**
U.S. PATENT DOCUMENTS
D313,662 S * 1/1991 Caires D26/37
D375,569 S * 11/1996 Hwang D26/37
D390,187 S * 2/1998 Urvoy D13/103
D510,722 S * 10/2005 Kosiba D13/103
D525,536 S * 7/2006 Chan D10/2
D568,240 S * 5/2008 Haydvogel D13/103
D580,349 S * 11/2008 Haydvogel D13/103

7,722,205 B2 * 5/2010 Kim A42B 3/044
248/229.12
D650,933 S * 12/2011 Cheng D26/37
D683,489 S * 5/2013 Lee D26/39
8,529,082 B1 * 9/2013 Baker F21V 33/0076
362/105
D696,803 S * 12/2013 Kingston D26/39
D726,356 S * 4/2015 Windom D13/103

* cited by examiner
Primary Examiner — Lakiya G Rogers
Assistant Examiner — Carissa C Fitts
(74) *Attorney, Agent, or Firm* — Law Offices of Steven
W. Weinrie

(57) **CLAIM**
The ornamental design for a dental LED headlight, as shown
and described.

DESCRIPTION
FIG. 1 is a perspective view of a dental LED headlight
showing my new design;
FIG. 2 is a front elevational view thereof;
FIG. 3 is a rear elevational view thereof;
FIG. 4 is a left side view thereof;
FIG. 5 is a right side view thereof;
FIG. 6 is a top plan view thereof; and,
FIG. 7 is a bottom plan view thereof.
The broken lines in the drawings illustrate portions of the
dental LED headlight which form no part of the claimed
design.

1 Claim, 7 Drawing Sheets

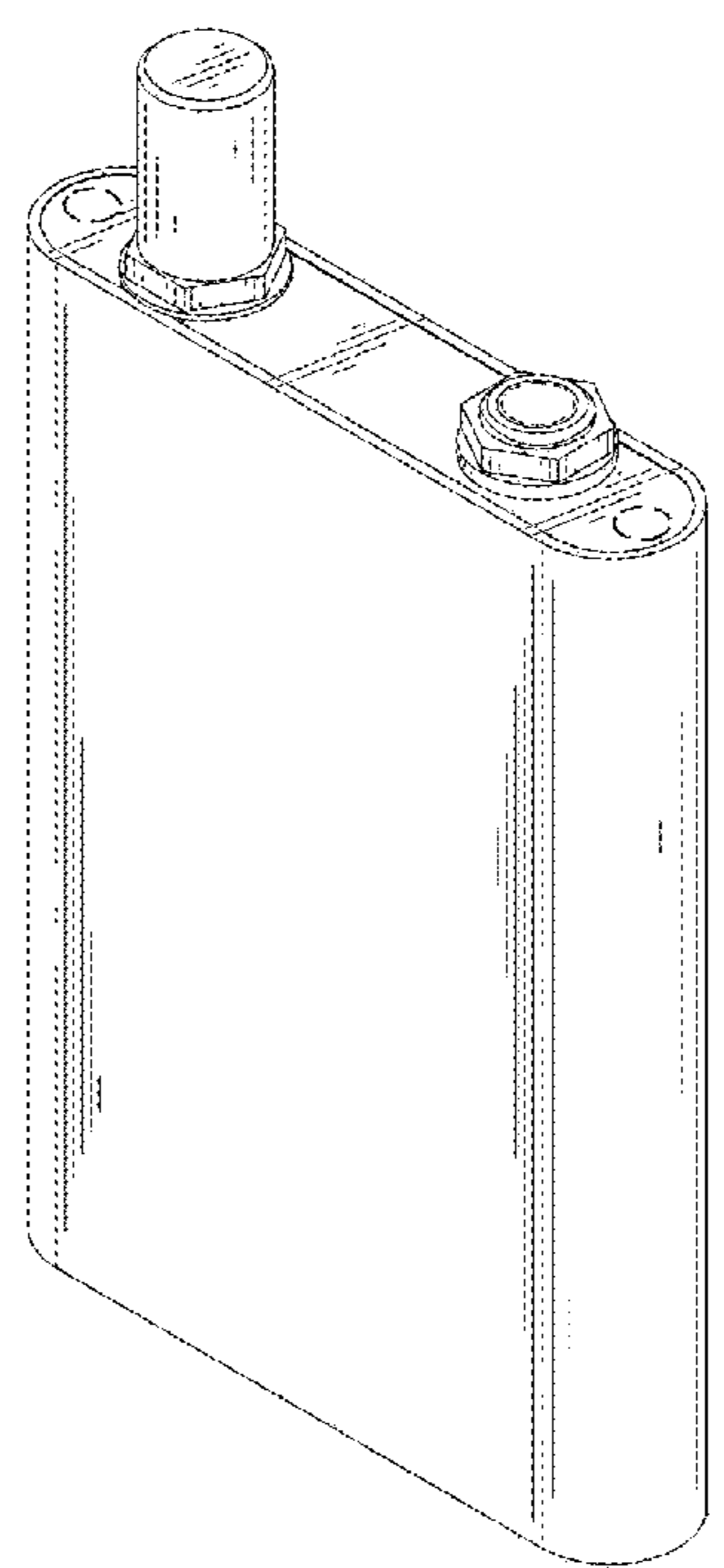

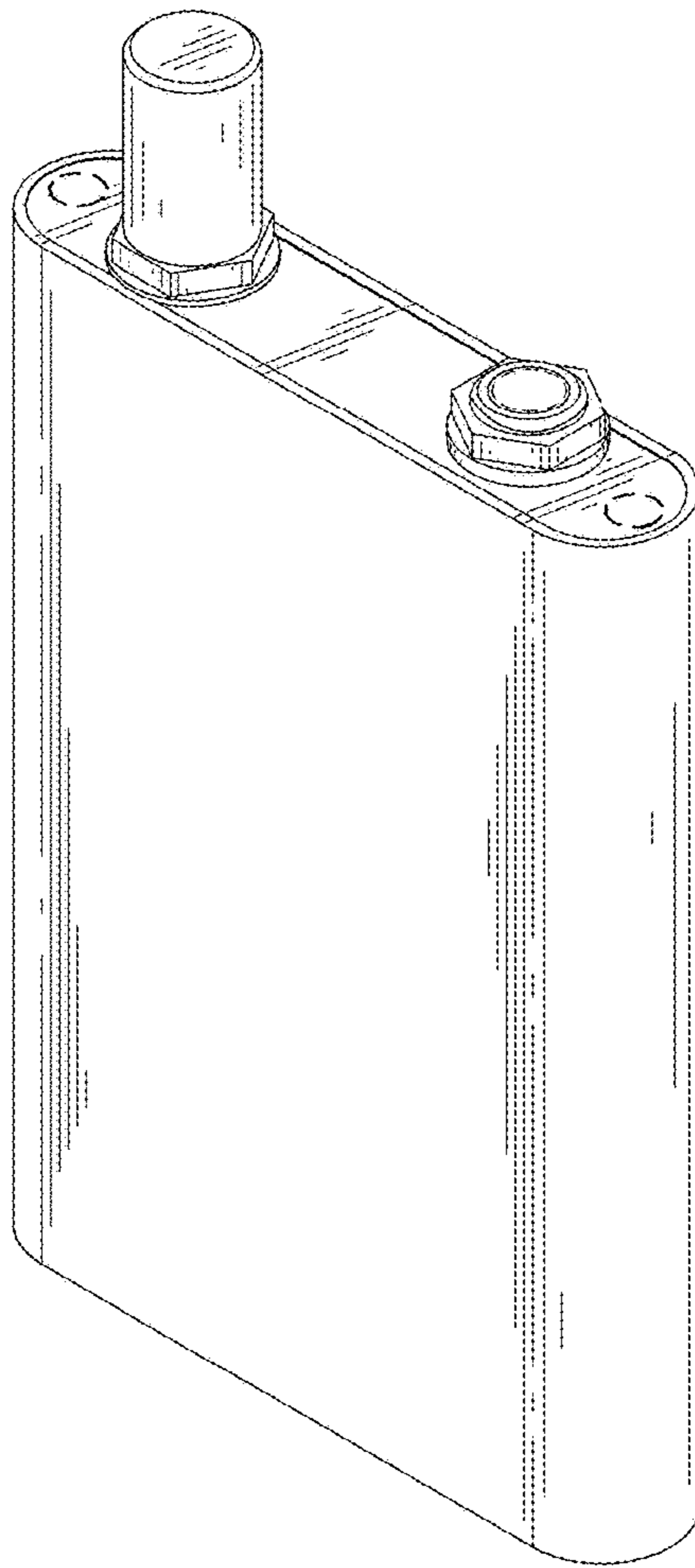

FIG. 1

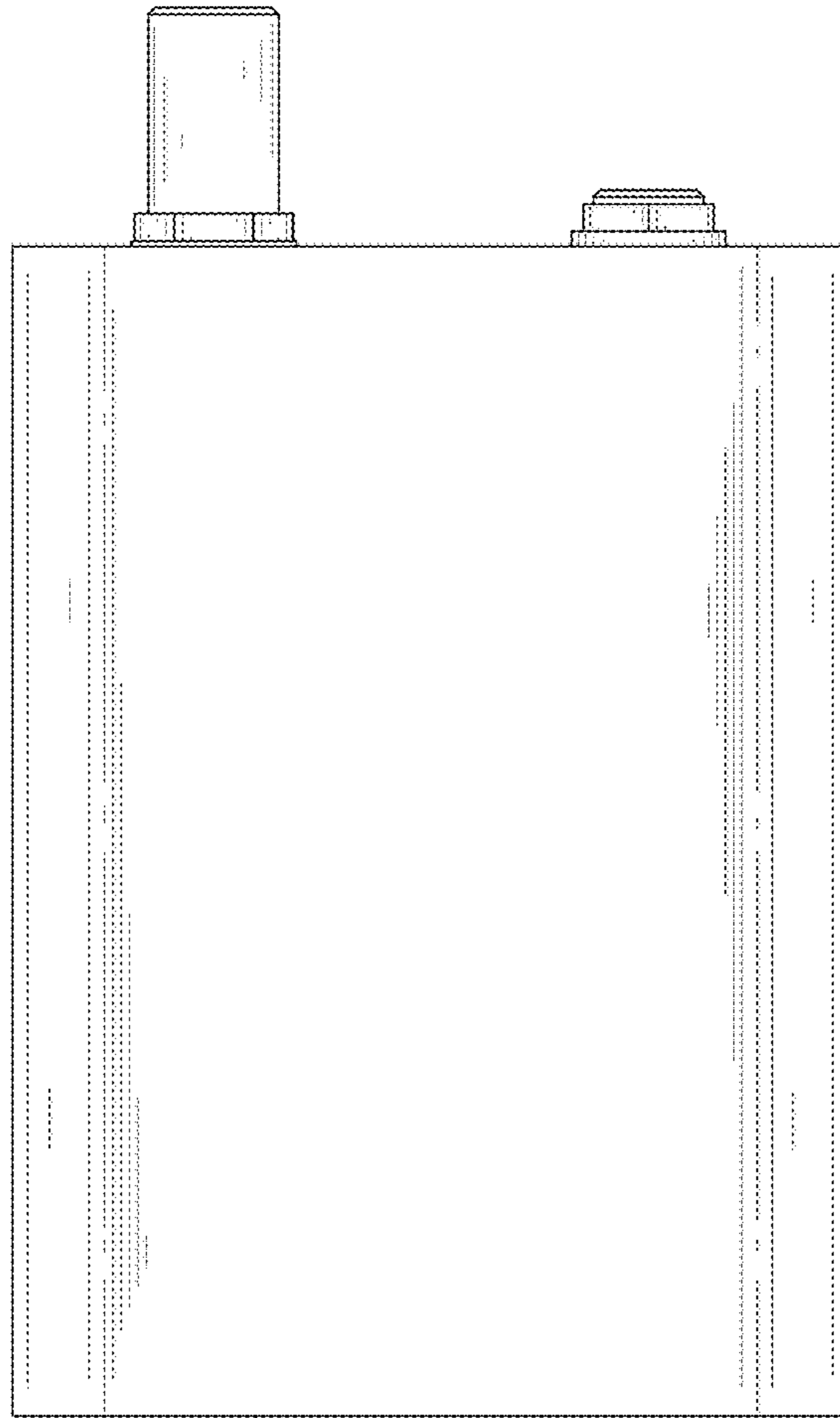

FIG. 2

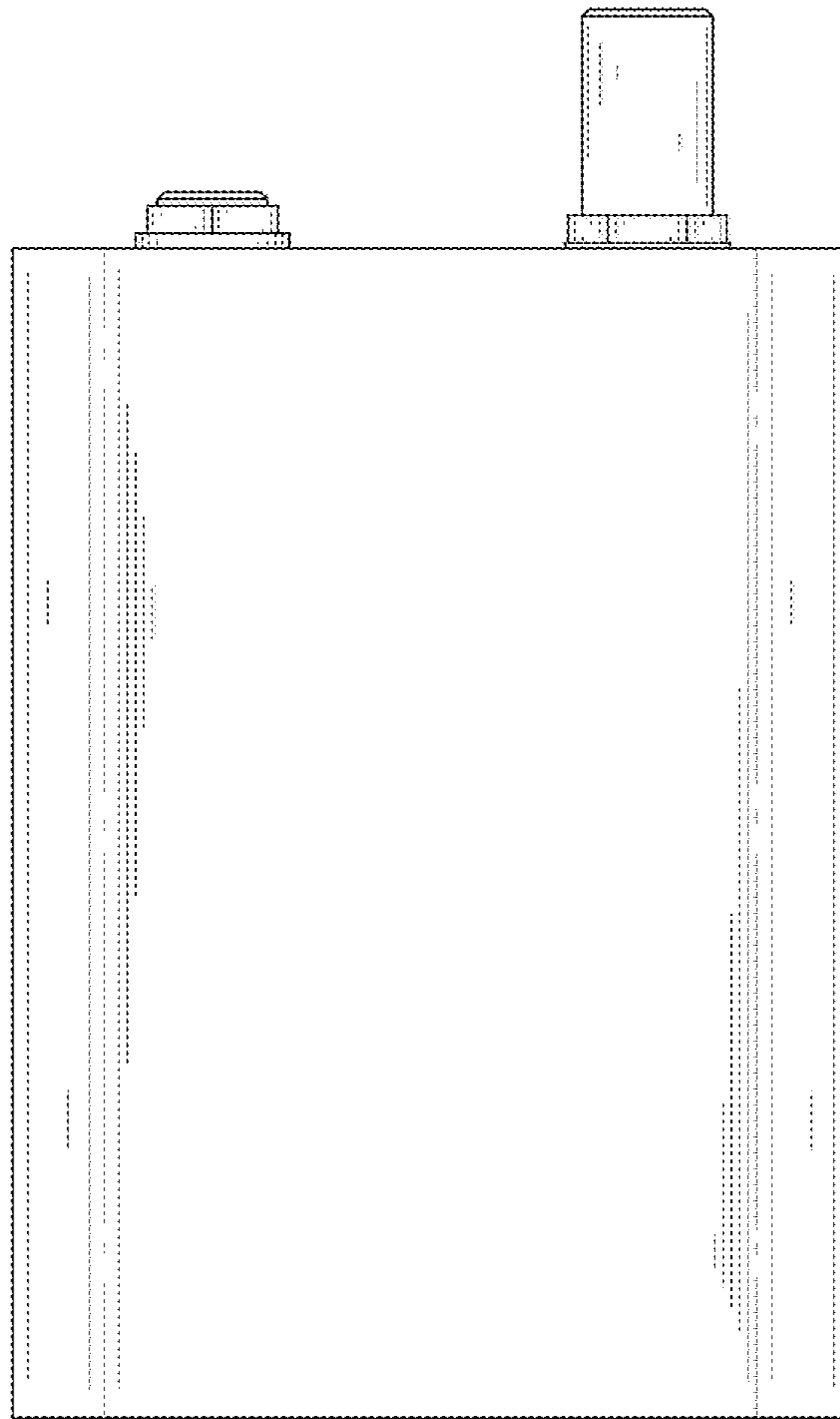

FIG. 3

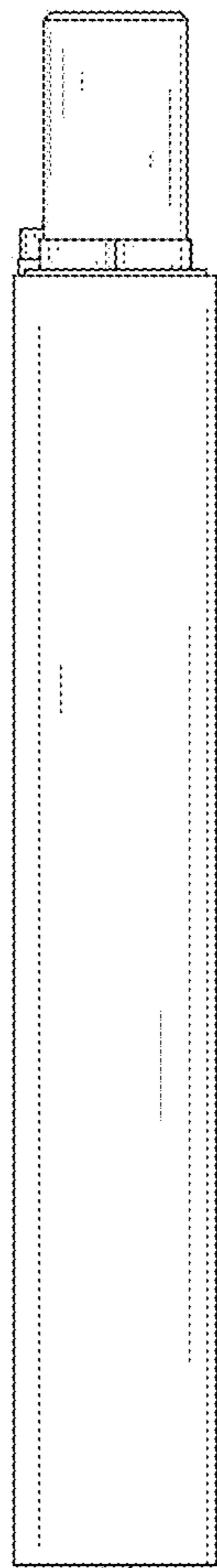

FIG. 4

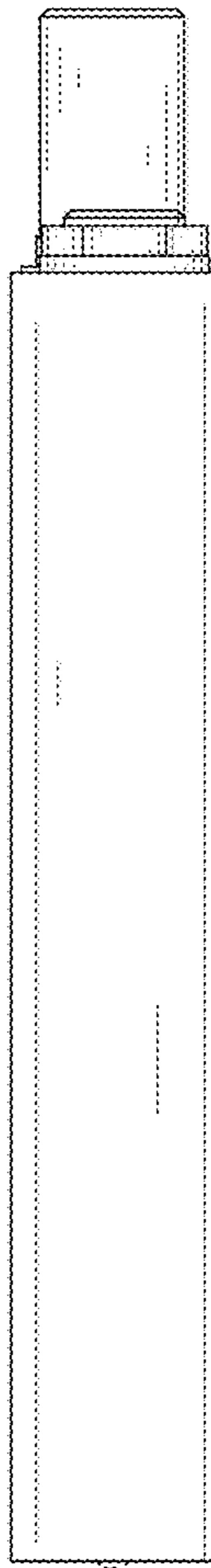

FIG. 5

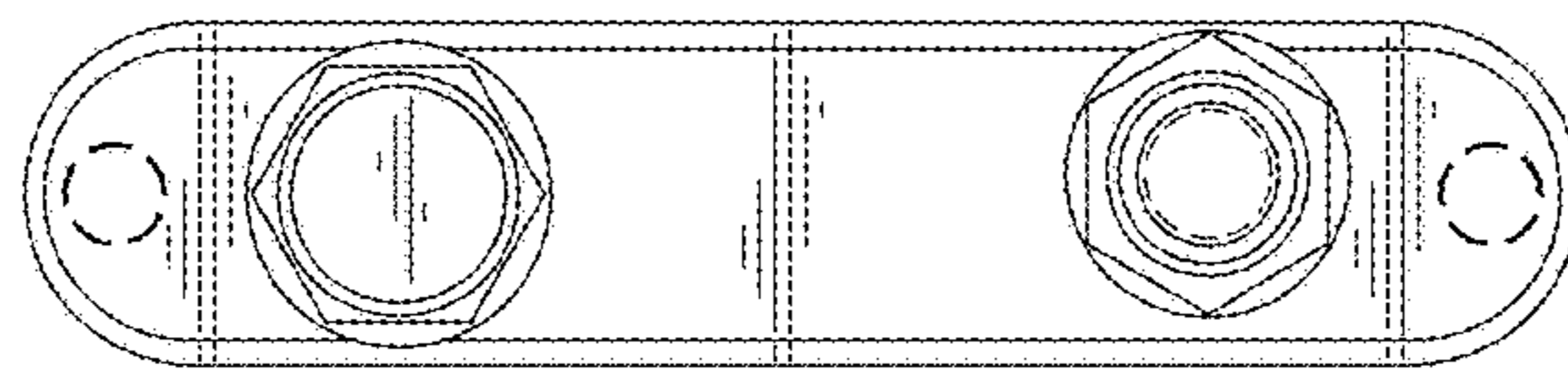

FIG. 6



FIG. 7