



US00D859677S

(12) **United States Design Patent**  
**Larsen et al.**

(10) **Patent No.:** **US D859,677 S**

(45) **Date of Patent:** **\*\* Sep. 10, 2019**

(54) **SPA SHELL**

(71) Applicant: **WATKINS MANUFACTURING CORPORATION**, Vista, CA (US)

(72) Inventors: **Christopher Carl Larsen**, Vista, CA (US); **Sage Nathan Baker**, Cardiff, CA (US); **Junko Funaki**, San Diego, CA (US)

(73) Assignee: **Watkins Manufacturing Corporation**, Vista, CA (US)

(\*\*) Term: **15 Years**

(21) Appl. No.: **29/632,002**

(22) Filed: **Jan. 4, 2018**

(51) **LOC (12) Cl.** ..... **23-02**

(52) **U.S. Cl.**  
USPC ..... **D24/204**

(58) **Field of Classification Search**  
USPC ..... D24/201–205, 213; D23/276–278, D23/280.1–280.3; D25/2  
CPC ..... A61H 33/6005; A61H 33/6021; A61H 33/6089; A61H 33/6094; A61H 2035/004; A61H 35/006; A47K 3/022; A47K 3/062  
See application file for complete search history.

(56) **References Cited**

**U.S. PATENT DOCUMENTS**

D621,946 S *	8/2010	Larsen	.....	D24/204
D624,657 S *	9/2010	Larsen	.....	D24/204
D726,328 S *	4/2015	Larsen	.....	D24/204
D773,677 S *	12/2016	Spicer	.....	D24/204
D773,678 S *	12/2016	Spicer	.....	D24/204
D773,679 S *	12/2016	Spicer	.....	D24/204
D781,431 S *	3/2017	Larsen	.....	D24/204
D781,432 S *	3/2017	Larsen	.....	D24/204

D782,056 S *	3/2017	Larsen	.....	D24/204
D782,057 S *	3/2017	Larsen	.....	D24/204
D799,053 S *	10/2017	Larsen	.....	D24/204
D810,953 S *	2/2018	Larsen	.....	D24/204
D810,954 S *	2/2018	Larsen	.....	D24/204

\* cited by examiner

*Primary Examiner* — Anhdao Doan

(74) *Attorney, Agent, or Firm* — Kirk W. Rudolph

(57) **CLAIM**

The ornamental design for a spa shell, as shown and described.

**DESCRIPTION**

FIG. 1 is a perspective view of a spa shell showing our new design;  
 FIG. 2 is another perspective view thereof;  
 FIG. 3 is a top plan view thereof;  
 FIG. 4 is a cross-sectional view thereof, taken in the direction of line 4-4 of FIG. 3;  
 FIG. 5 is a cross-sectional view thereof, taken in the direction of line 5-5 of FIG. 3;  
 FIG. 6 is a cross-sectional view thereof, taken in the direction of line 6-6 of FIG. 3;  
 FIG. 7 is a cross-sectional view thereof, taken in the direction of line 7-7 of FIG. 3;  
 FIG. 8 is a cross-sectional view thereof, taken in the direction of line 8-8 of FIG. 3;  
 FIG. 9 is a cross-sectional view thereof, taken in the direction of line 9-9 of FIG. 3;  
 FIG. 10 is a cross-sectional view thereof, taken in the direction of line 10-10 of FIG. 3; and,  
 FIG. 11 is a cross-sectional view thereof, taken in the direction of line 11-11 of FIG. 3.  
 The broken lines show portions of the spa shell that form no part of the claimed design.

**1 Claim, 7 Drawing Sheets**

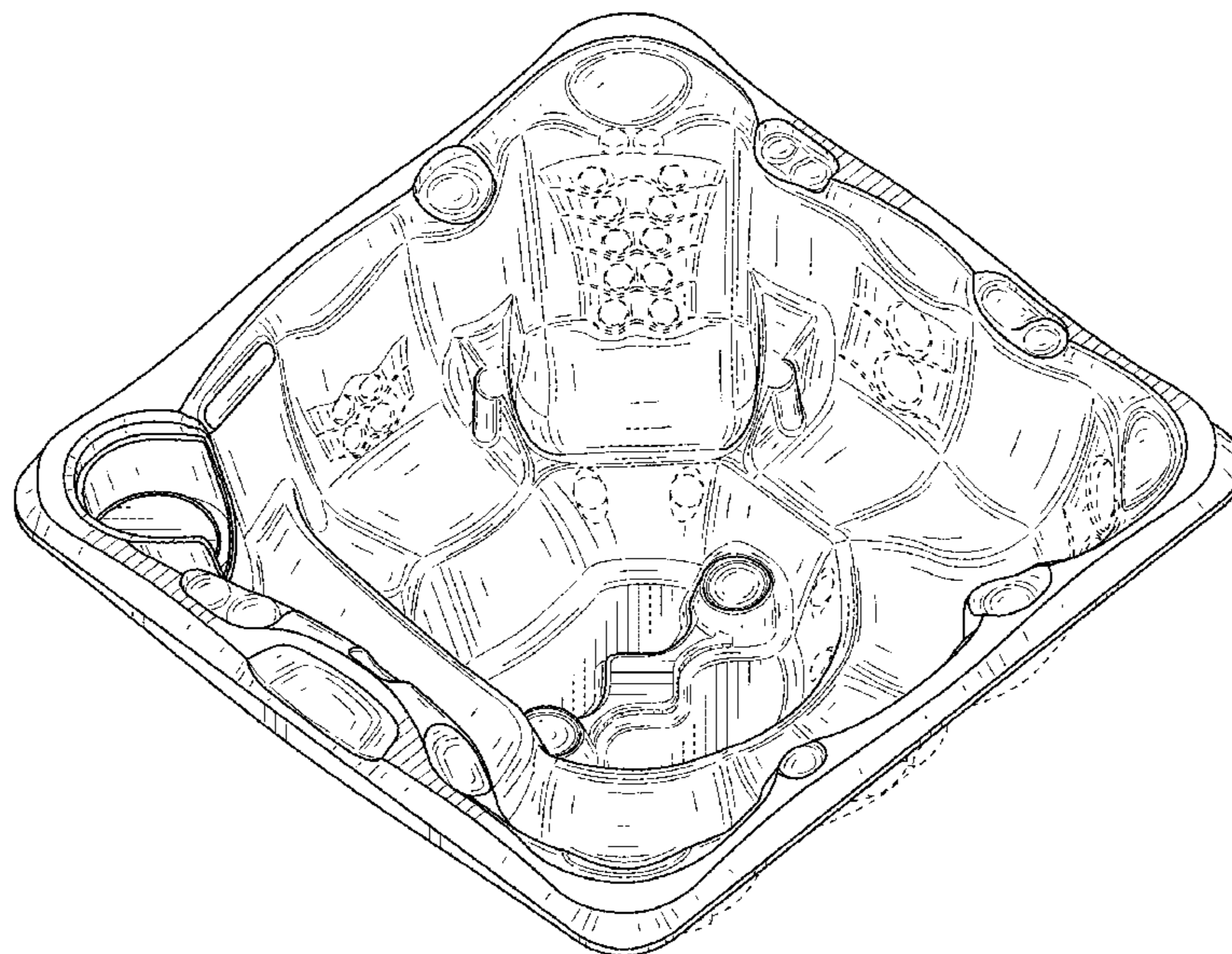

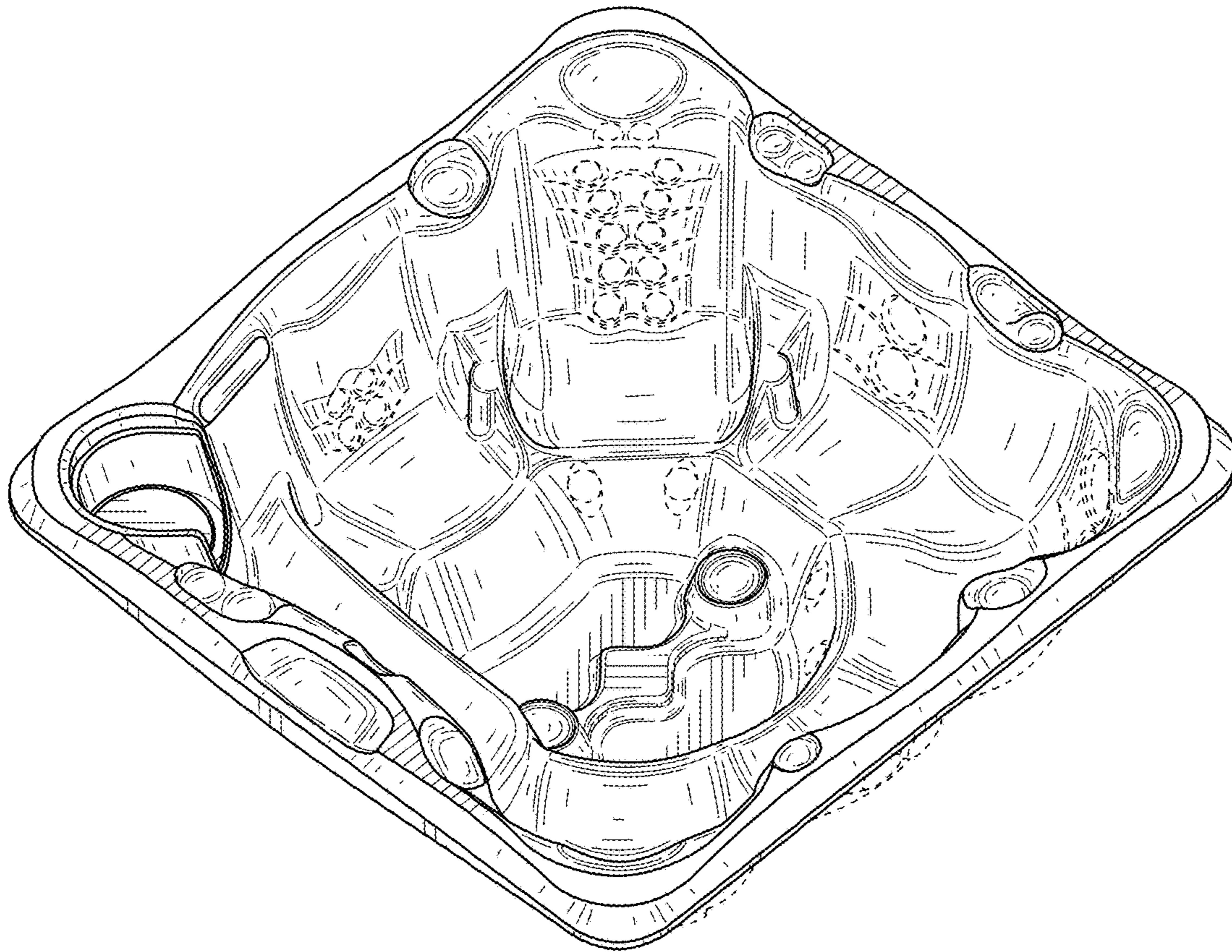

FIG. 1



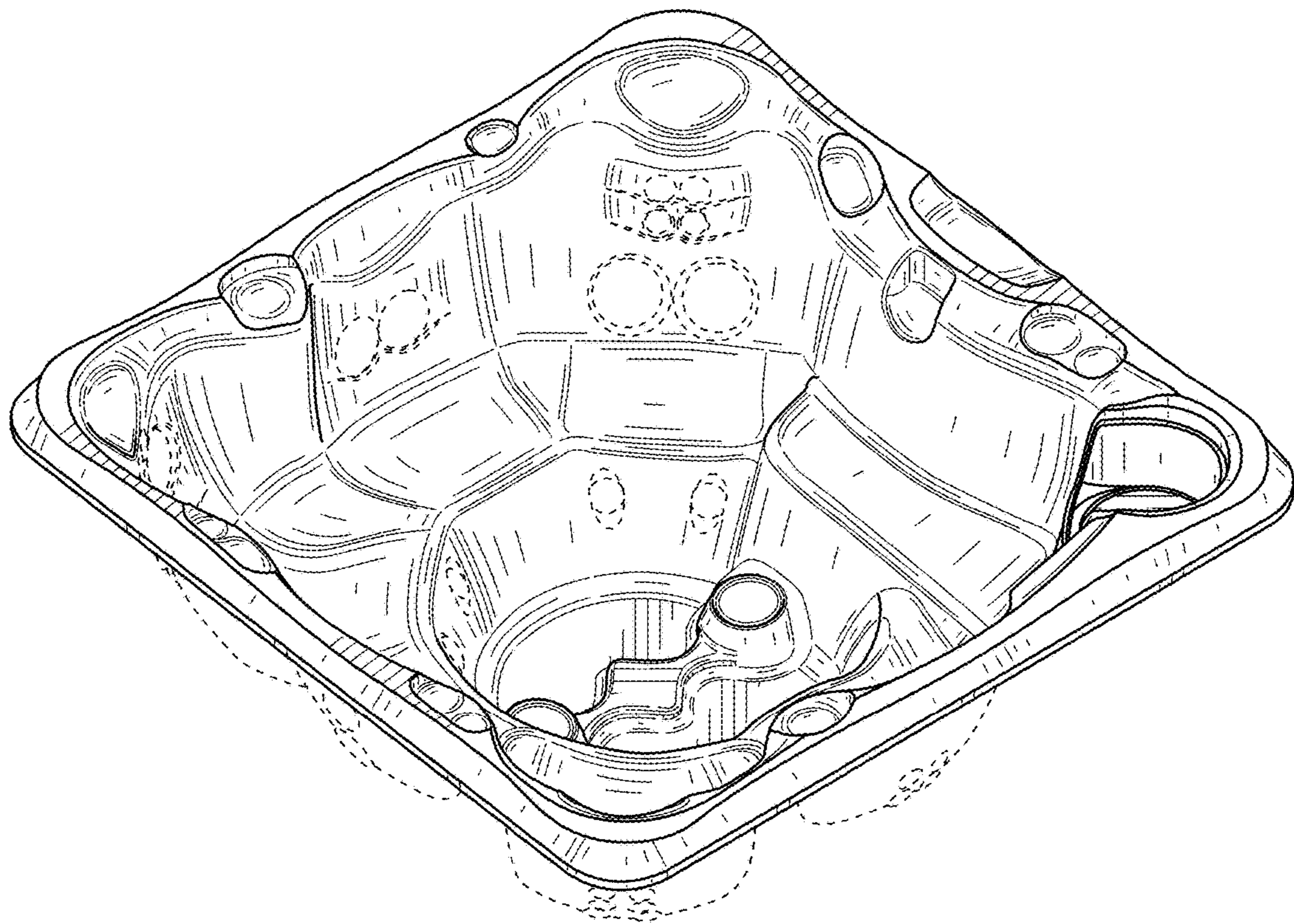

FIG. 2

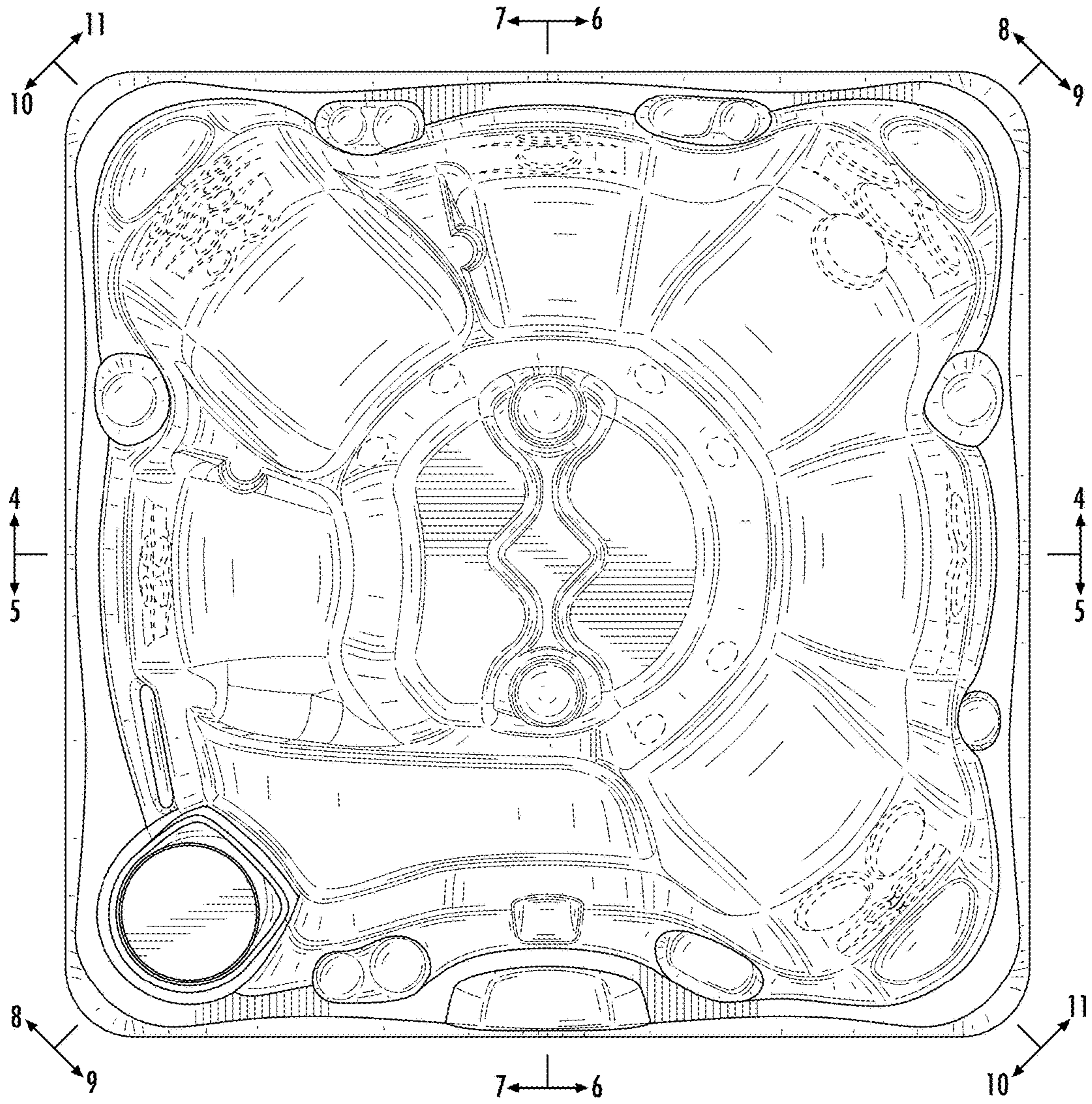

FIG. 3



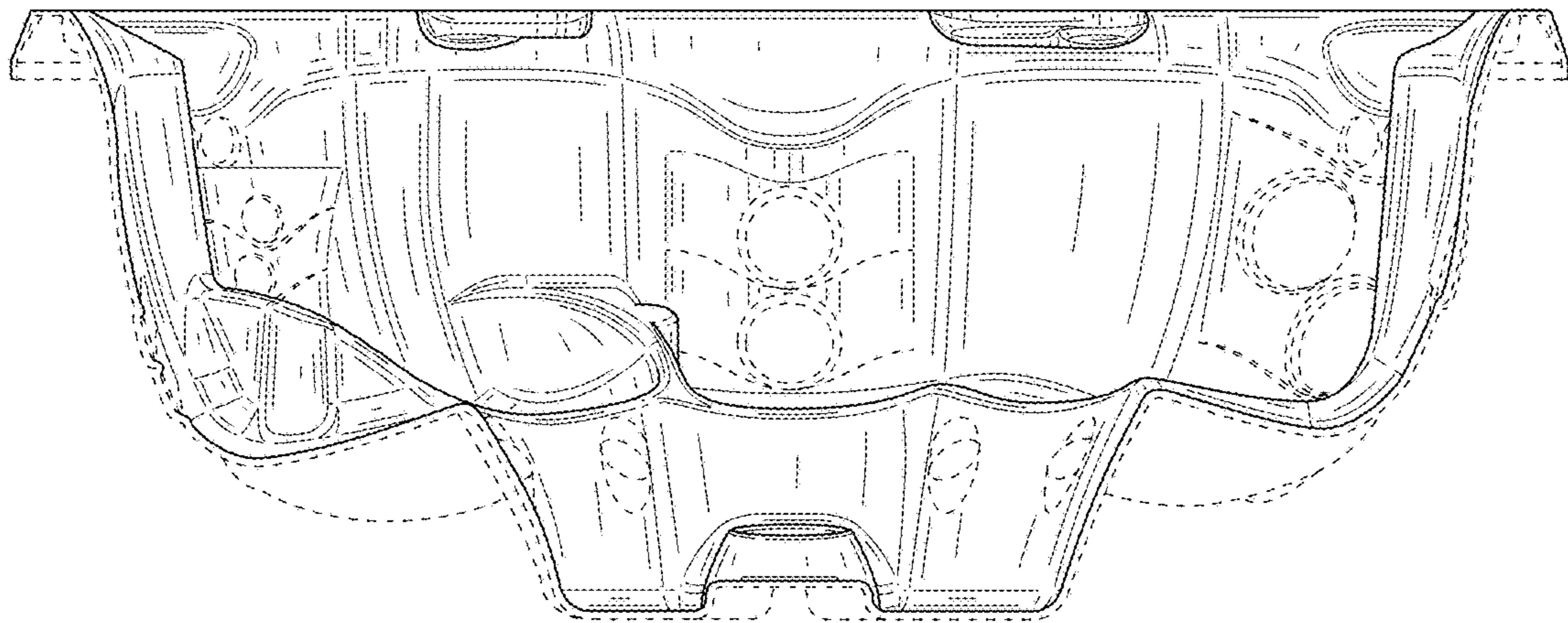

FIG. 4

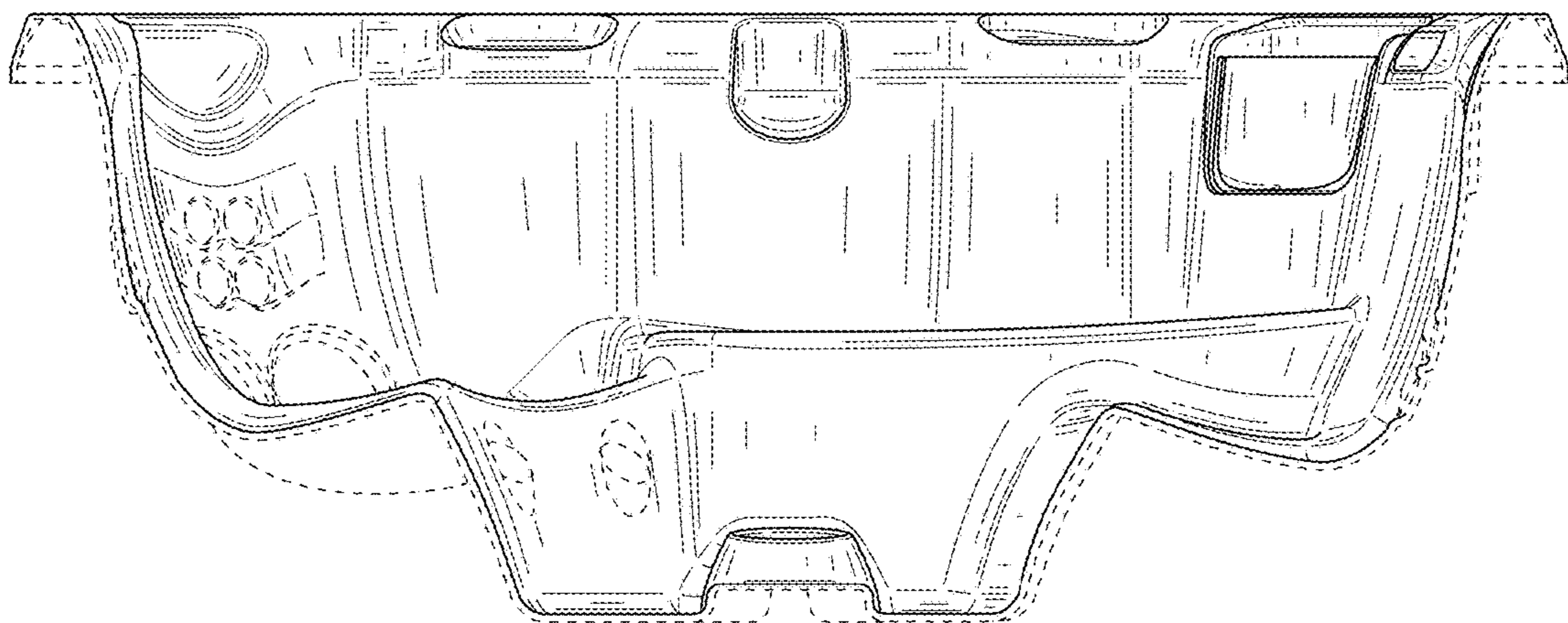

FIG. 5

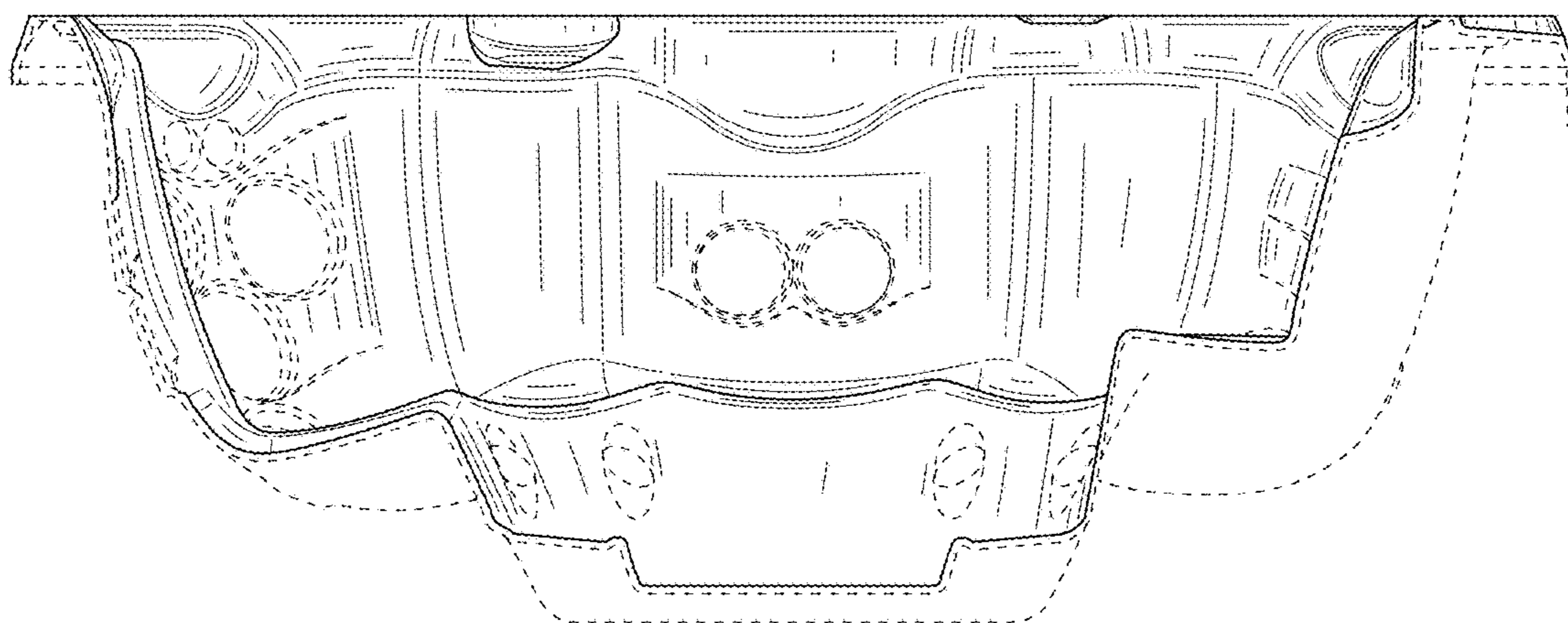

FIG. 6

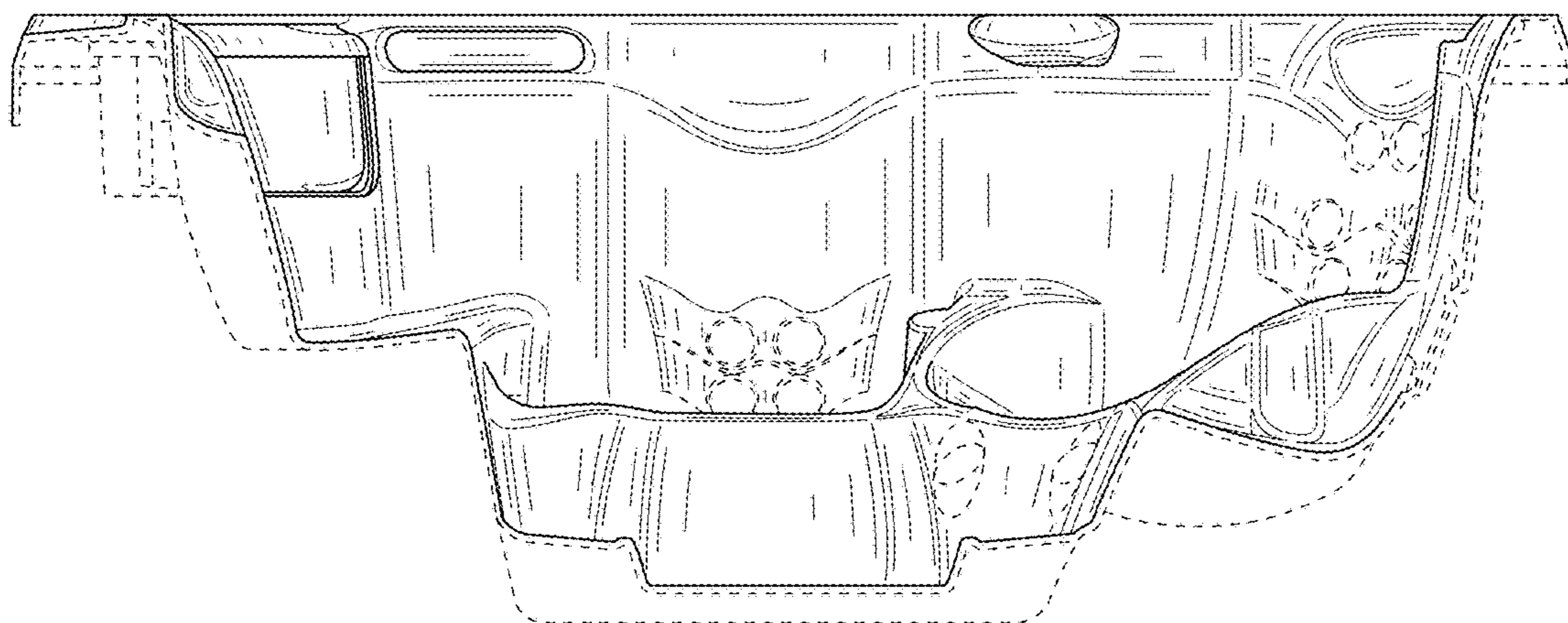

FIG. 7

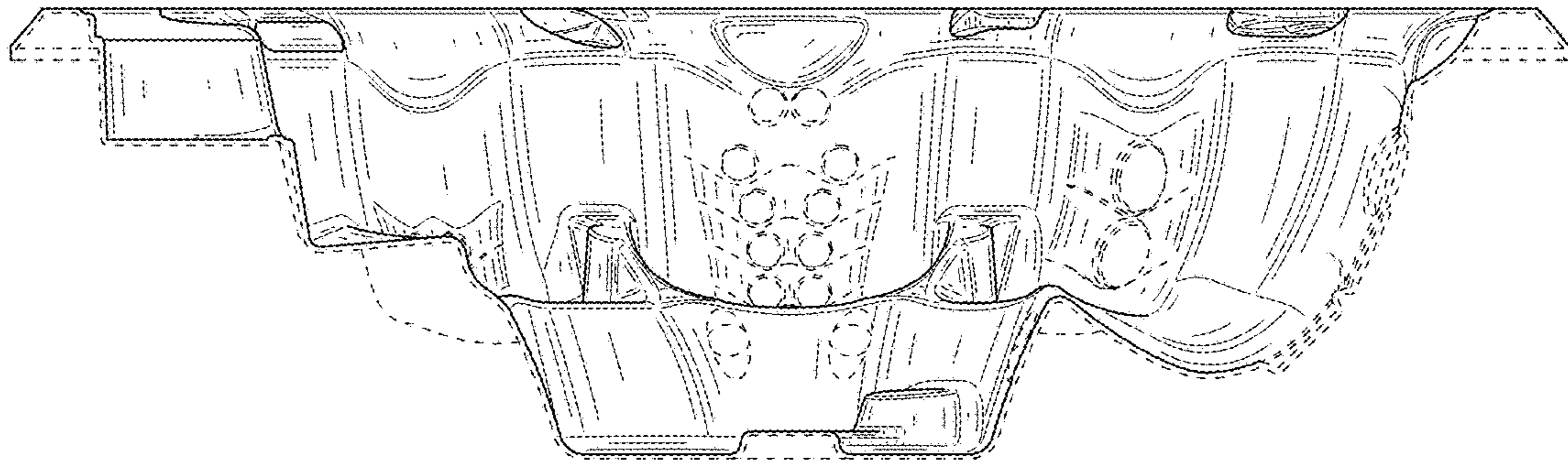

FIG. 8

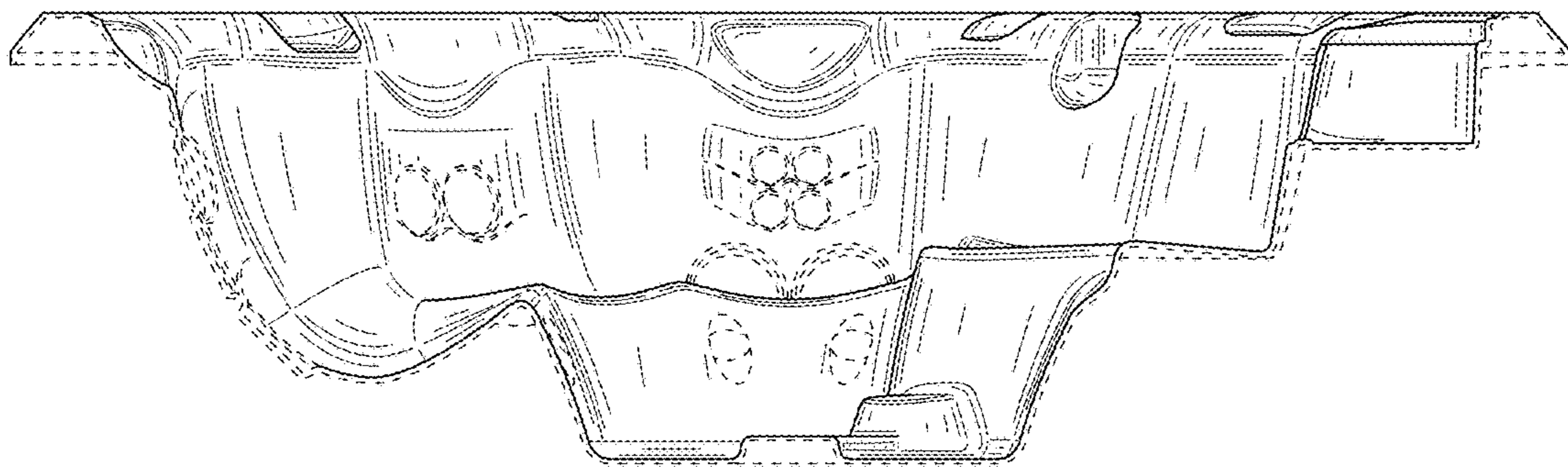

FIG. 9



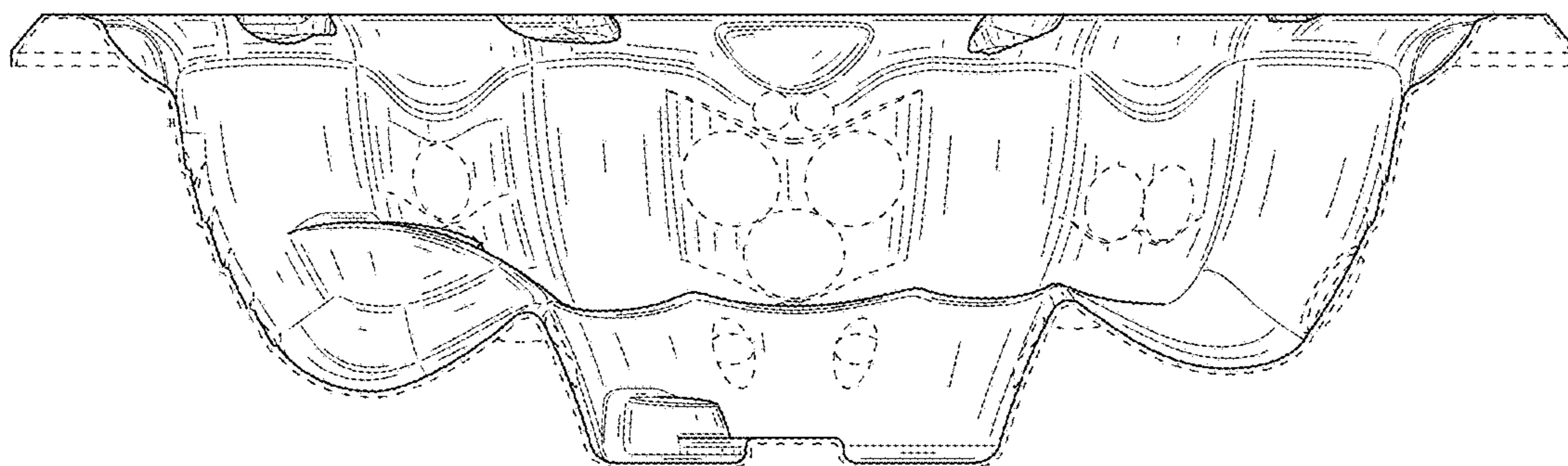

FIG. 10

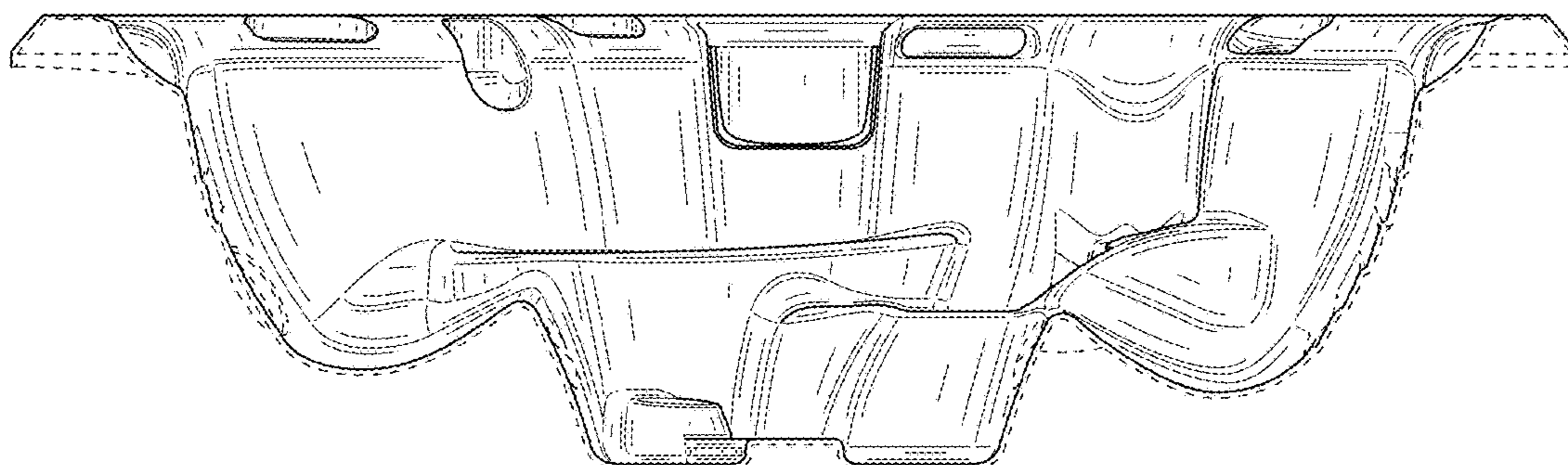

FIG. 11