

US00D859646S

(12) **United States Design Patent** (10) **Patent No.:** **US D859,646 S**
Scampoli et al. (45) **Date of Patent:** **** Sep. 10, 2019**

(54) **NASAL CANNULA**

CPC A61B 17/3421; A61B 17/3423; A61B 17/0218; A61M 16/0666; A61M 16/0672
See application file for complete search history.

(71) Applicant: **KONINKLIJKE PHILIPS N.V.**,
Eindhoven (NL)

(56) **References Cited**

(72) Inventors: **David Scampoli**, South Glastonbury,
CT (US); **Philip D'Almada Remedios**,
Palm Harbor, FL (US); **Kathryn**
Wozniak, Birmingham, AL (US);
Mario Simoes, Pinellas Park, FL (US)

U.S. PATENT DOCUMENTS

D228,692 S * 10/1973 King D24/110
D300,962 S * 5/1989 Johnson D24/110
D665,496 S * 8/2012 Lee D24/110.5
D744,637 S * 12/2015 Scampoli D24/110.5
D745,141 S * 12/2015 Hung A61M 16/0683
D24/110.5
D752,735 S * 3/2016 Scampoli D24/110.5
D806,857 S * 1/2018 Hua D24/110

(73) Assignee: **KONINKLIJKE PHILIPS N.V.**,
Eindhoven (NL)

(Continued)

(**) Term: **15 Years**

Primary Examiner — Eliza Z Bennett-Hattan

(21) Appl. No.: **35/504,334**

(57) **CLAIM**

The ornamental design for a nasal cannula, as shown and described.

(22) Filed: **Jul. 13, 2017**

DESCRIPTION

(80) **Hague Agreement Data**

Int. Filing Date: **Jul. 13, 2017**

Int. Reg. No.: **DM/097294**

Int. Reg. Date: **Jul. 13, 2017**

Int. Reg. Pub. Date: **Jan. 19, 2018**

The patent or application file contains at least one drawing executed in color. Copies of this patent or patent application publication with color drawing(s) will be provided by the Office upon request and payment of the necessary fee.

1.-2. Nasal cannula

1.1 is a front perspective view of a first embodiment of a nasal cannula showing our design;

1.2 is a front elevational view thereof;

1.3 is a rear elevational view thereof;

1.4 is a left side elevational view thereof;

1.5 is a right side elevational view thereof;

1.6 is a top plan view thereof; and

1.7 is a bottom plan view thereof;

2.1 is a front perspective view of a second embodiment of a nasal cannula showing our design;

2.2 is a front elevational view thereof;

2.3 is a rear elevational view thereof;

2.4 is a left side elevational view hereof;

2.5 is a right side elevational view thereof;

2.6 is a top plan view thereof; and

(Continued)

(30) **Foreign Application Priority Data**

Jan. 23, 2017 (EM) 003693506-0001

Jan. 23, 2017 (EM) 003693506-0002

(51) **LOC (12) Cl.** **24-02**

(52) **U.S. Cl.**

USPC **D24/112**

(58) **Field of Classification Search**

USPC D24/135, 133, 110, 112, 110.1, 110.4,

D24/110.5, 164

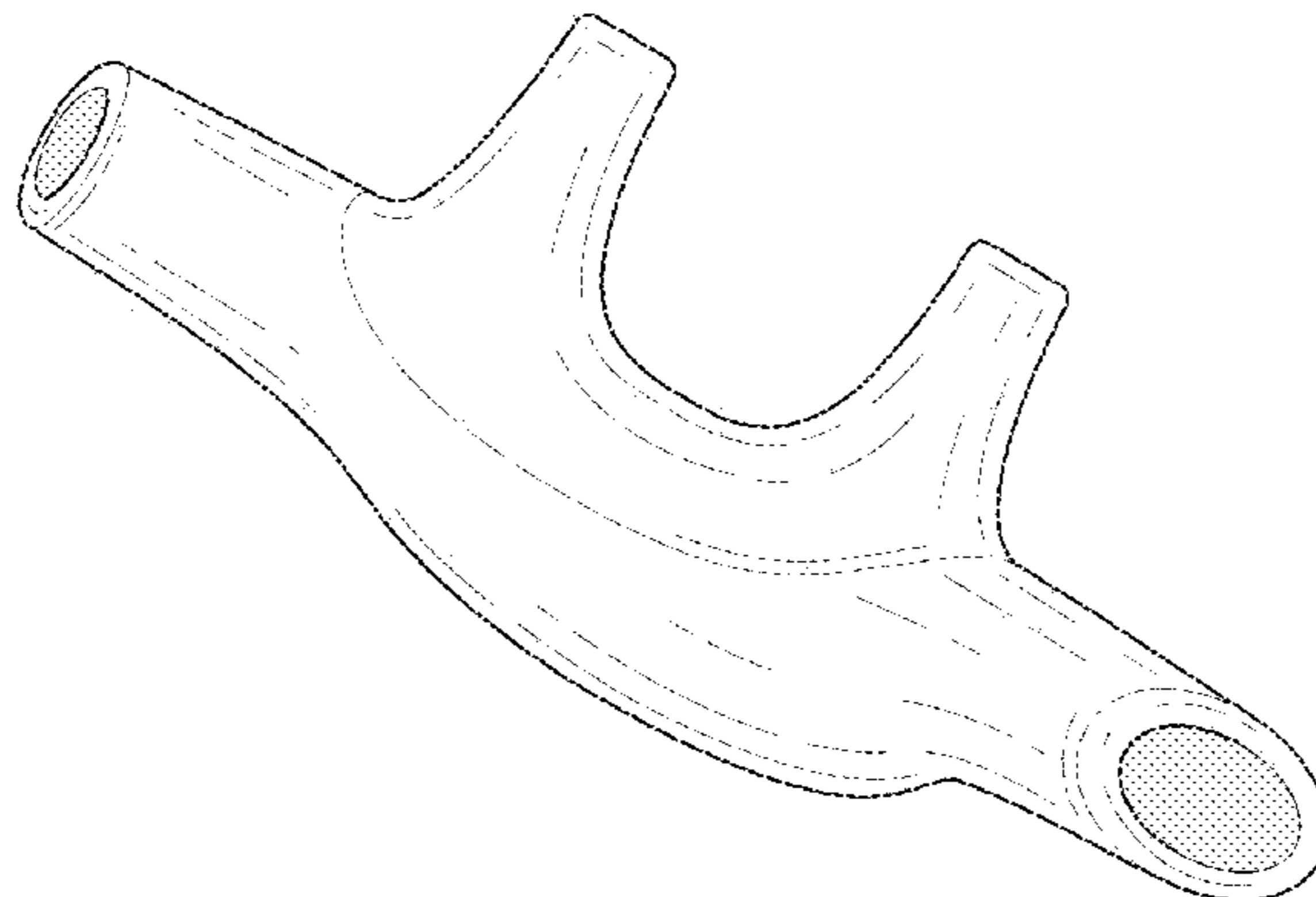

2.7 is a bottom plan view thereof.
The portions of the nasal cannula shown in the color yellow
form no part of the claimed design.

1 Claim, 8 Drawing Sheets
(8 of 8 Drawing Sheet(s) Filed in Color)

(56)

References Cited

U.S. PATENT DOCUMENTS

2007/0107737 A1* 5/2007 Landis A61M 16/0666
128/207.18
2009/0292258 A1* 11/2009 Turner A61M 16/0666
604/263
2011/0073116 A1* 3/2011 Genger A61M 16/0666
128/207.18
2017/0049986 A1* 2/2017 Scampoli B29C 45/36
2017/0216547 A1* 8/2017 O'Neill A61M 16/0672

* cited by examiner

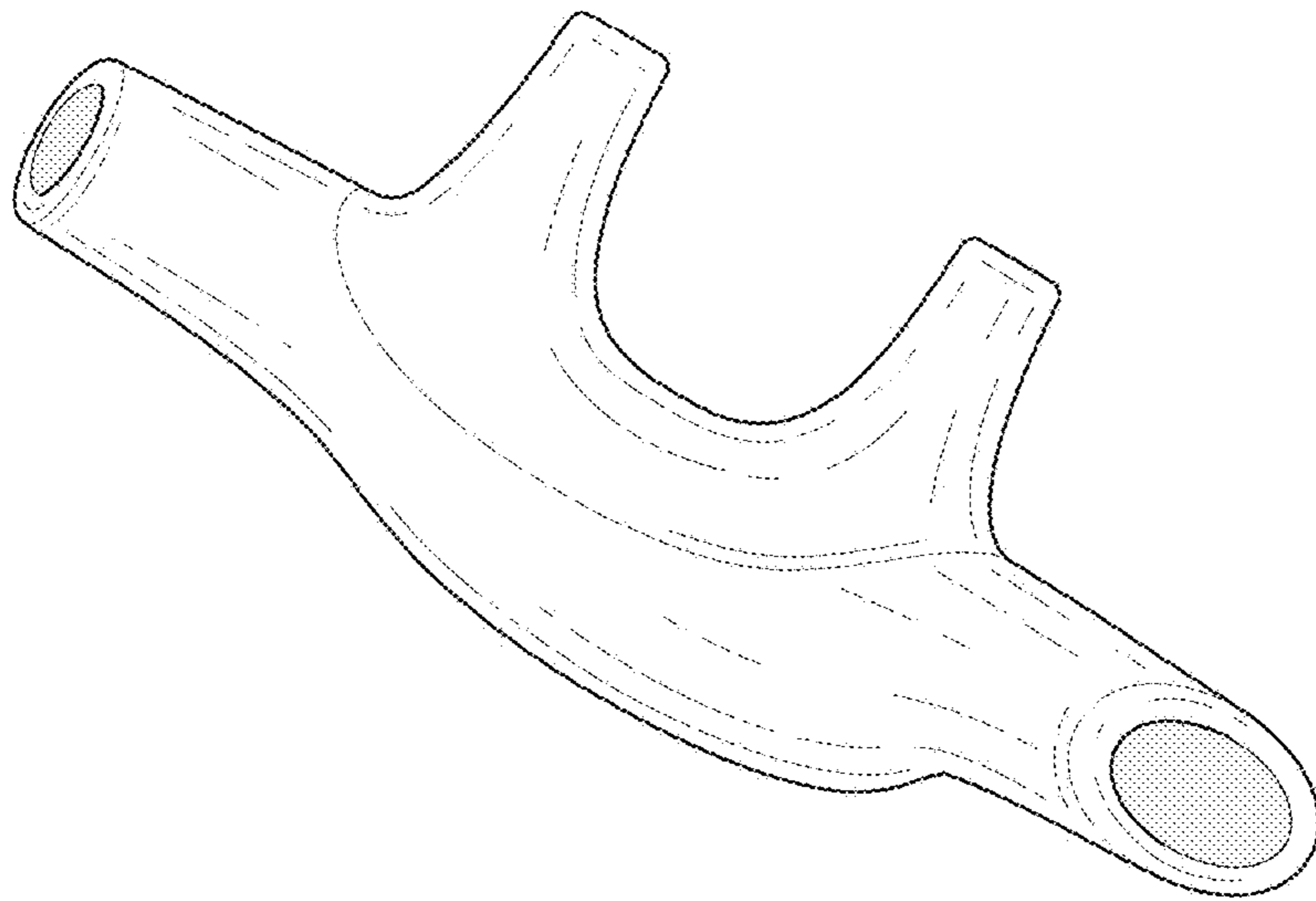

1.1

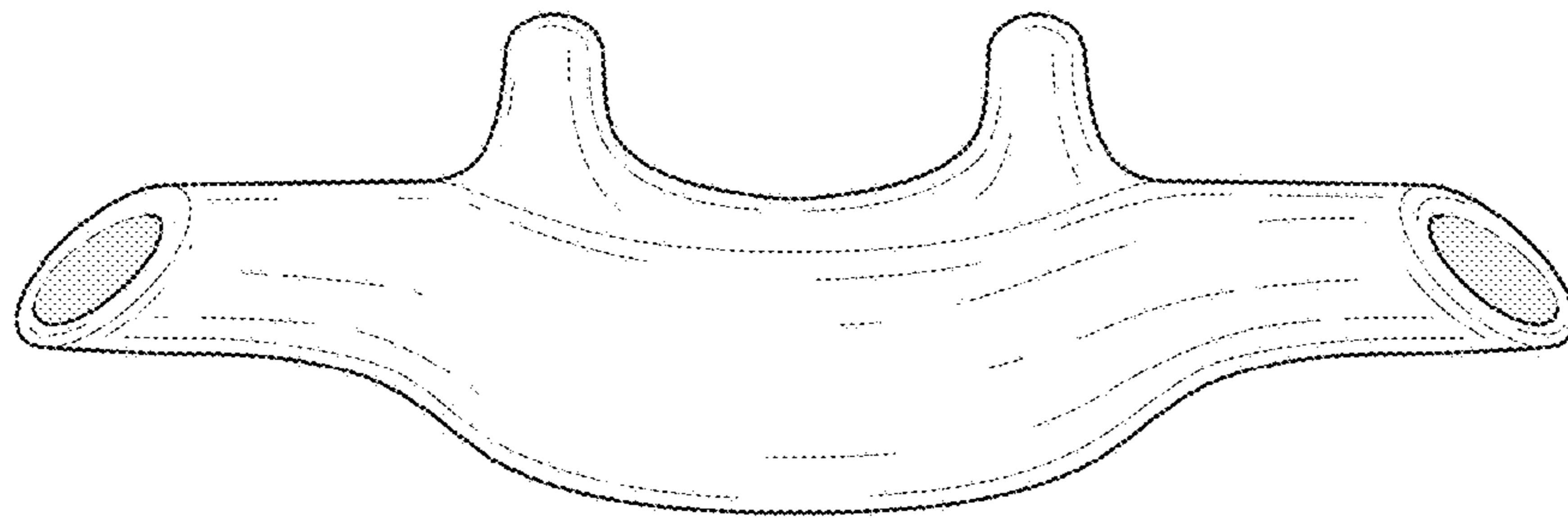

1.2

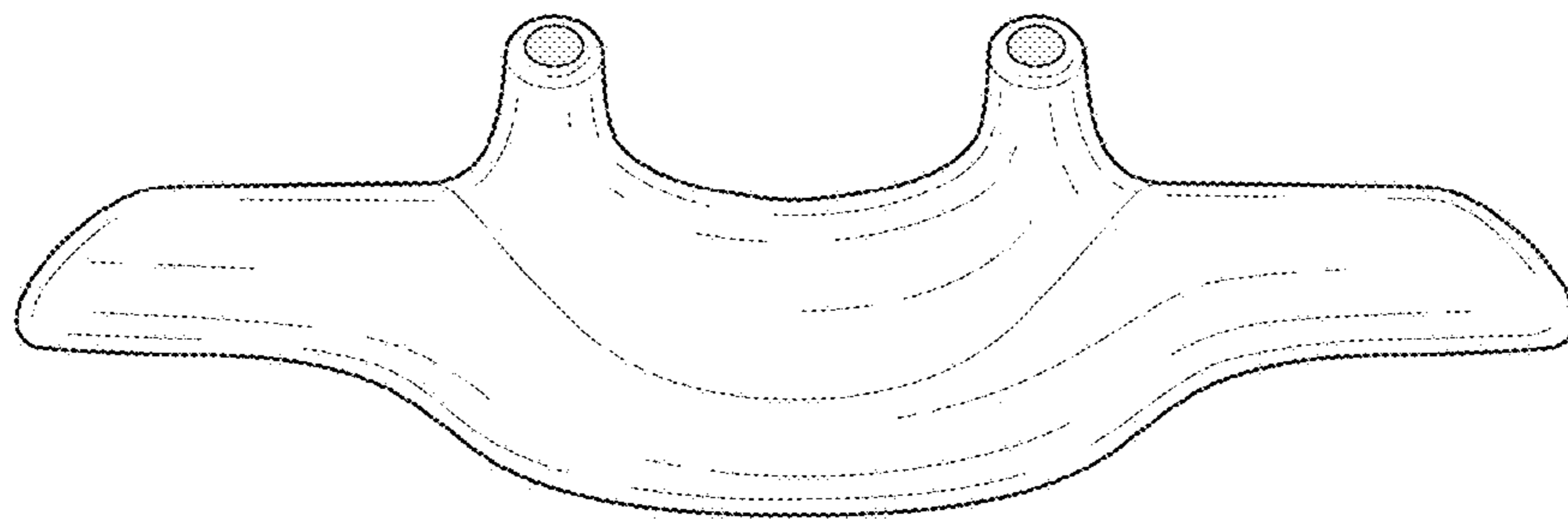

1.3

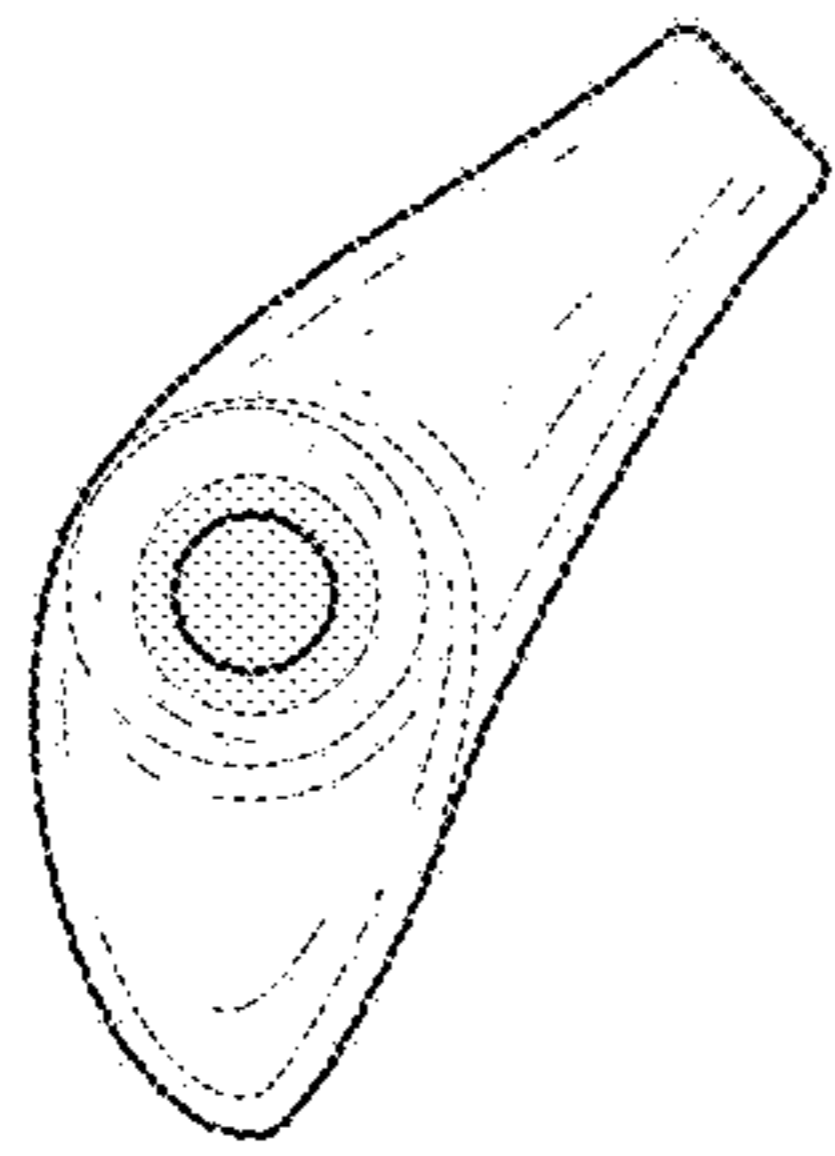

1.4

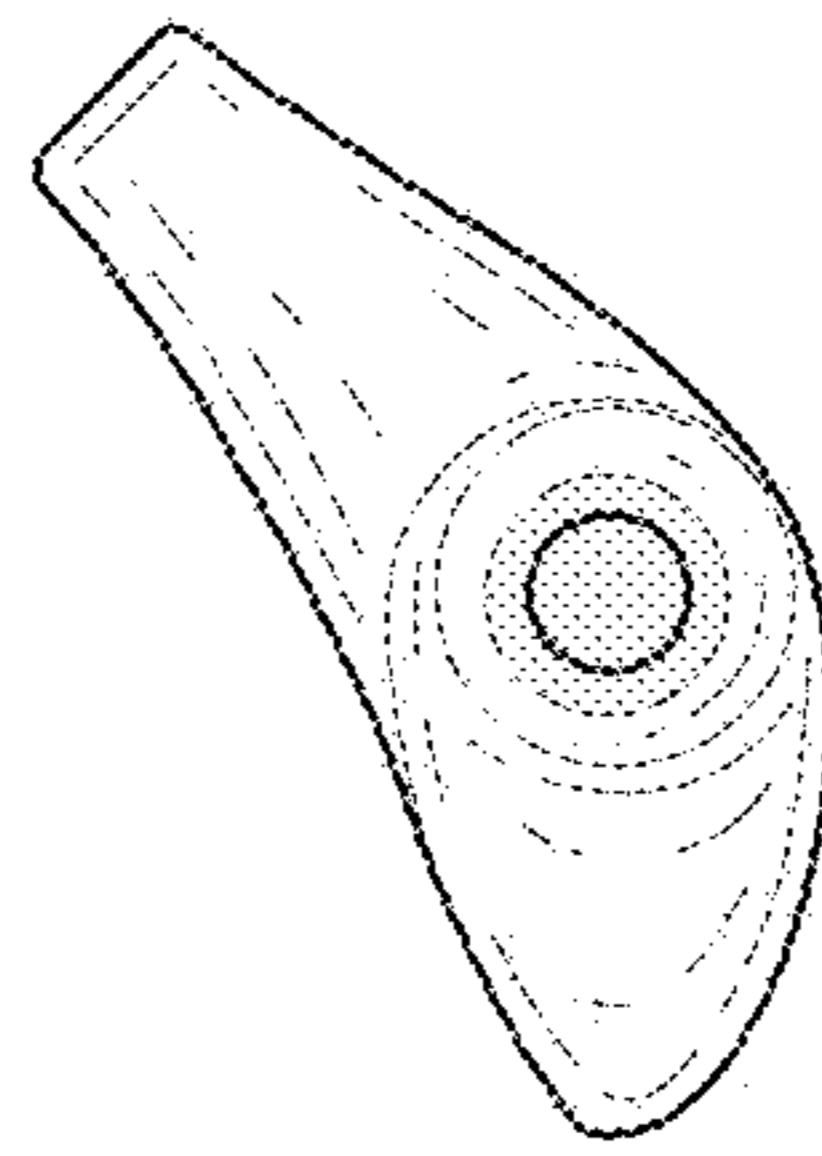

1.5

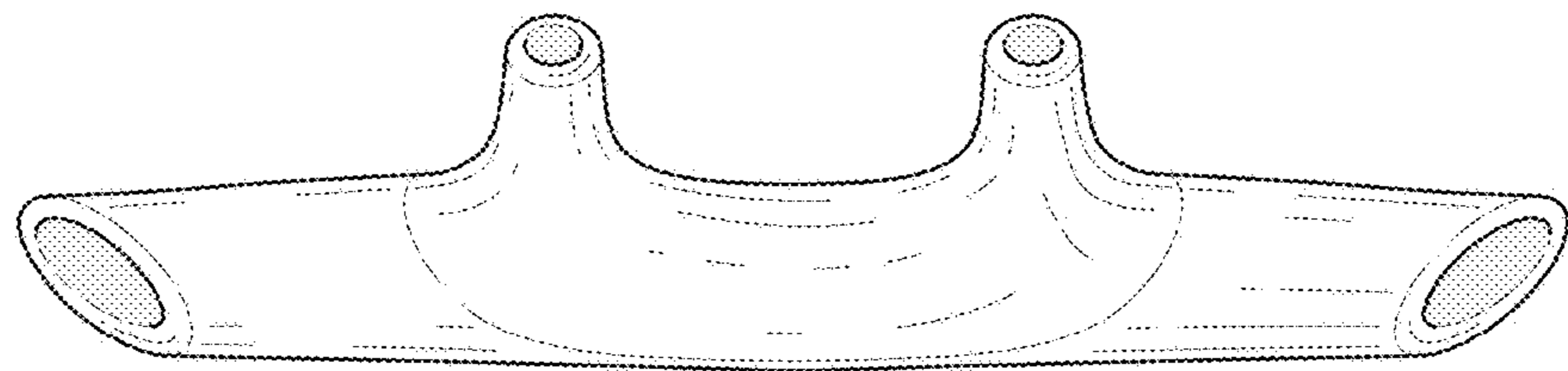

1.6

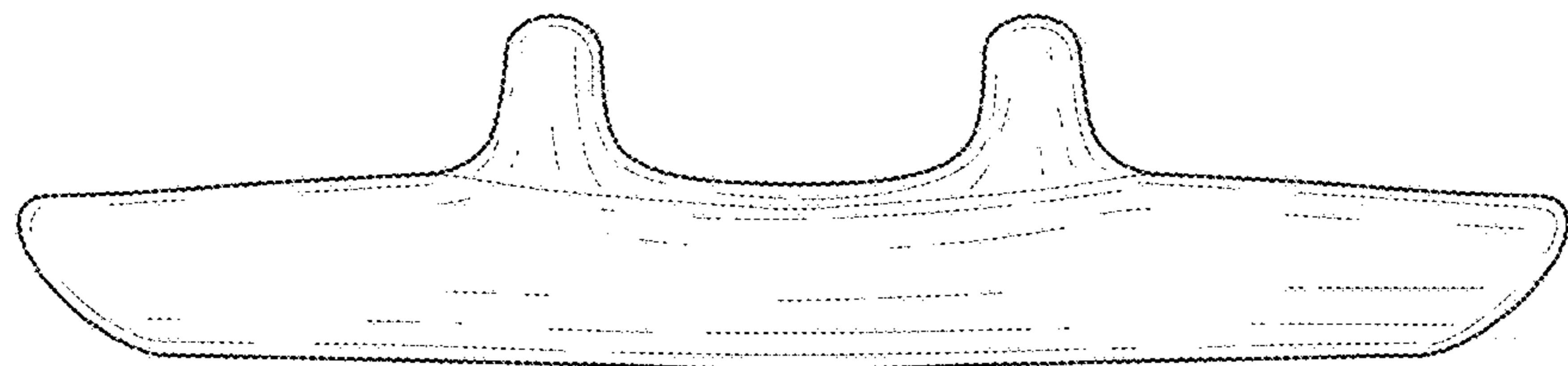

1.7

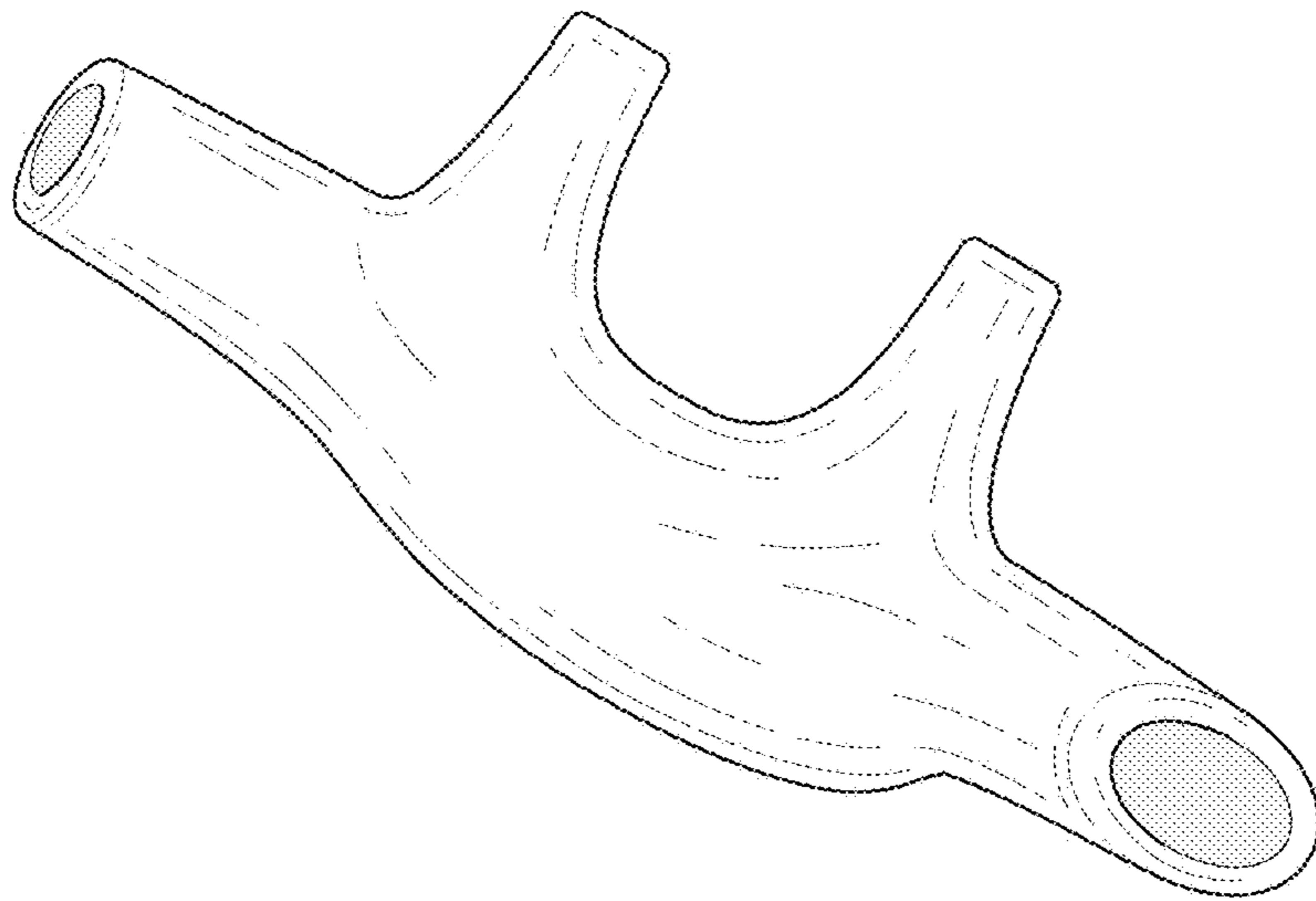

2.1

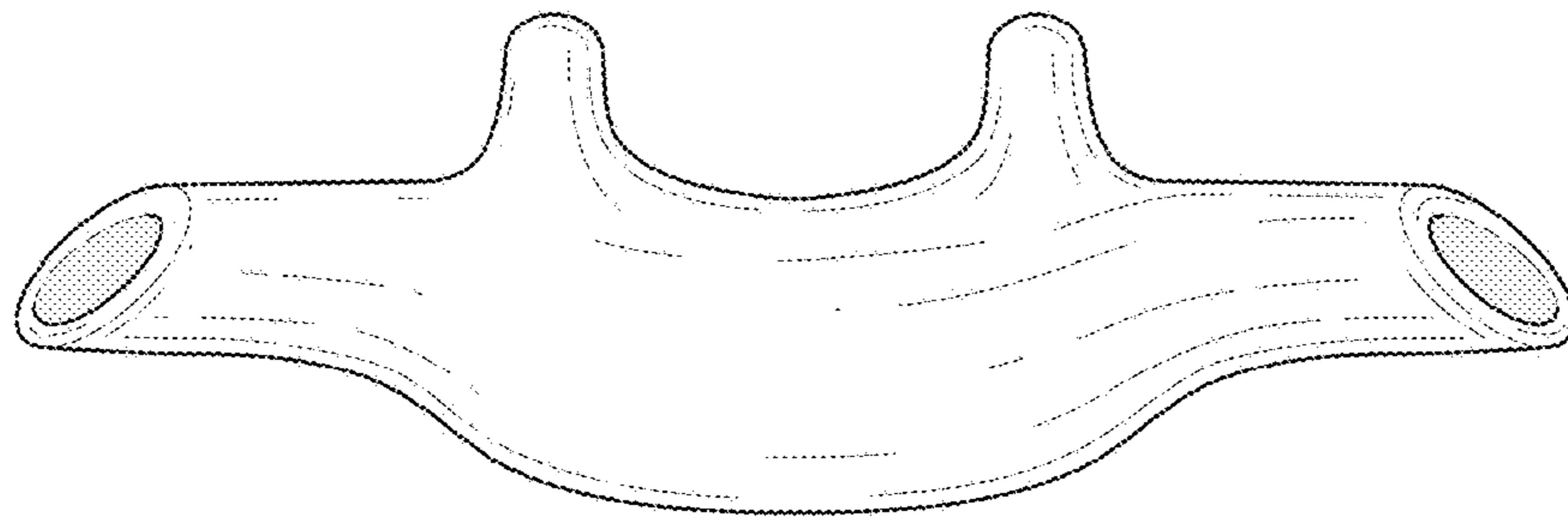

2.2

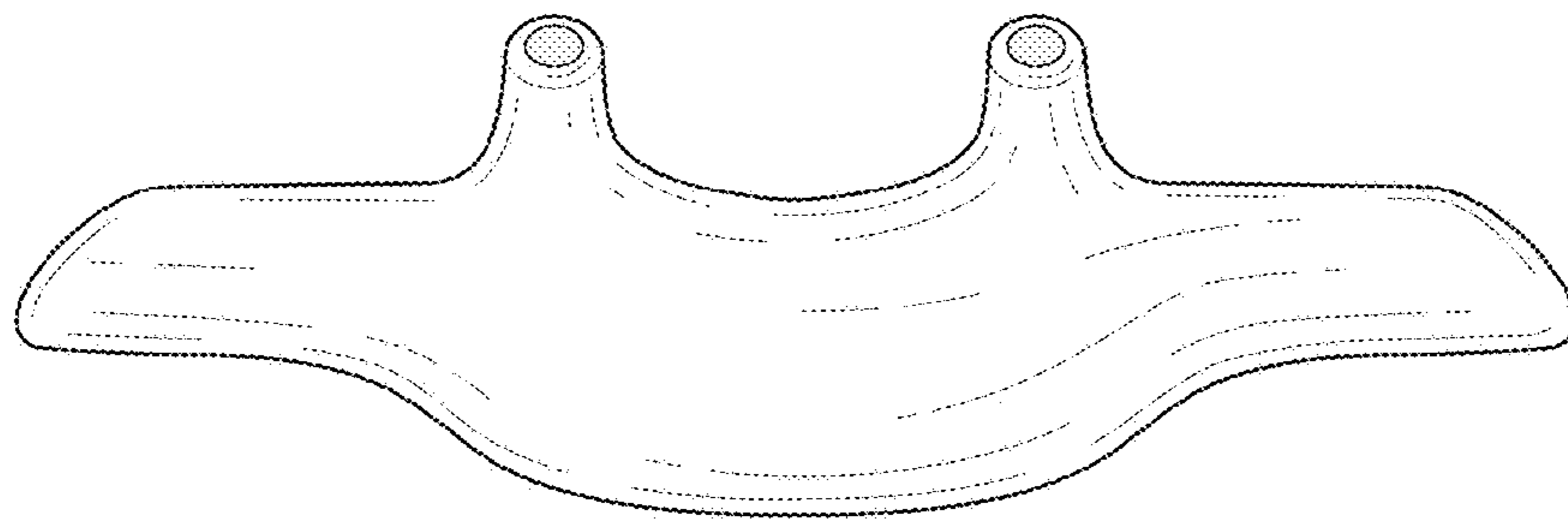

2.3

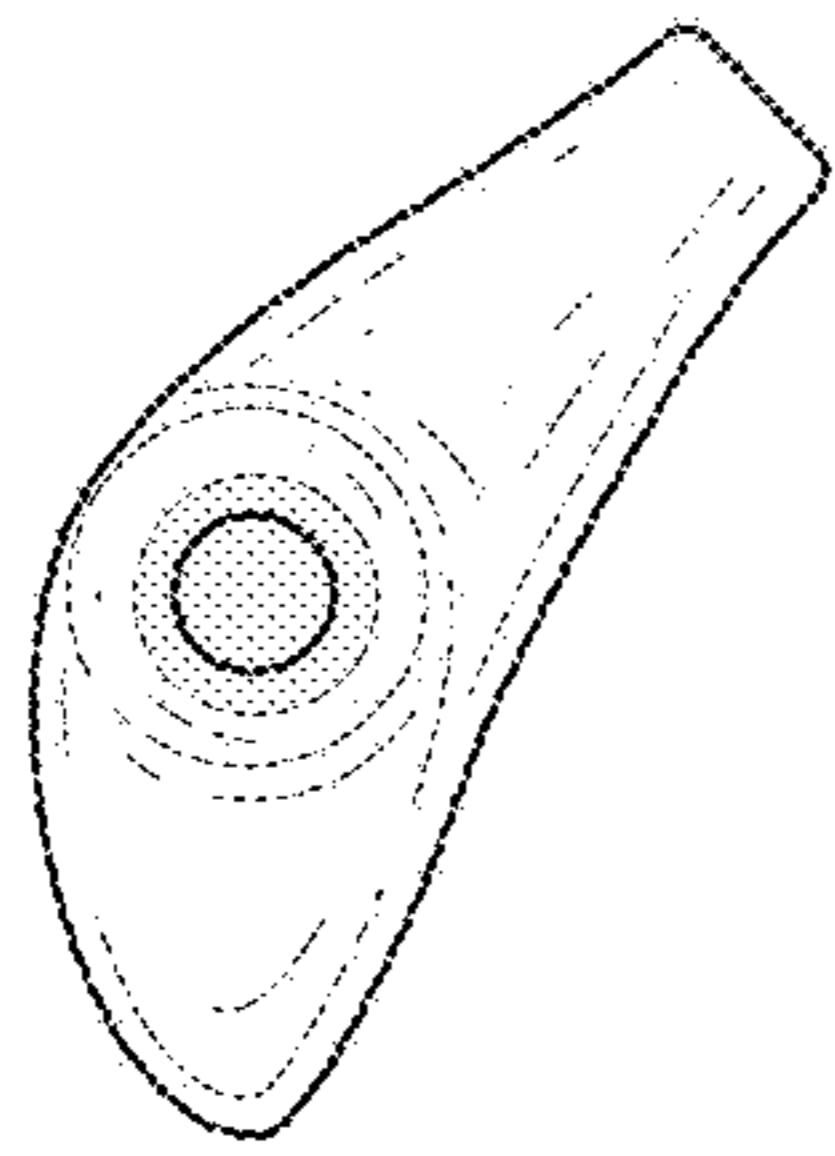

2.4

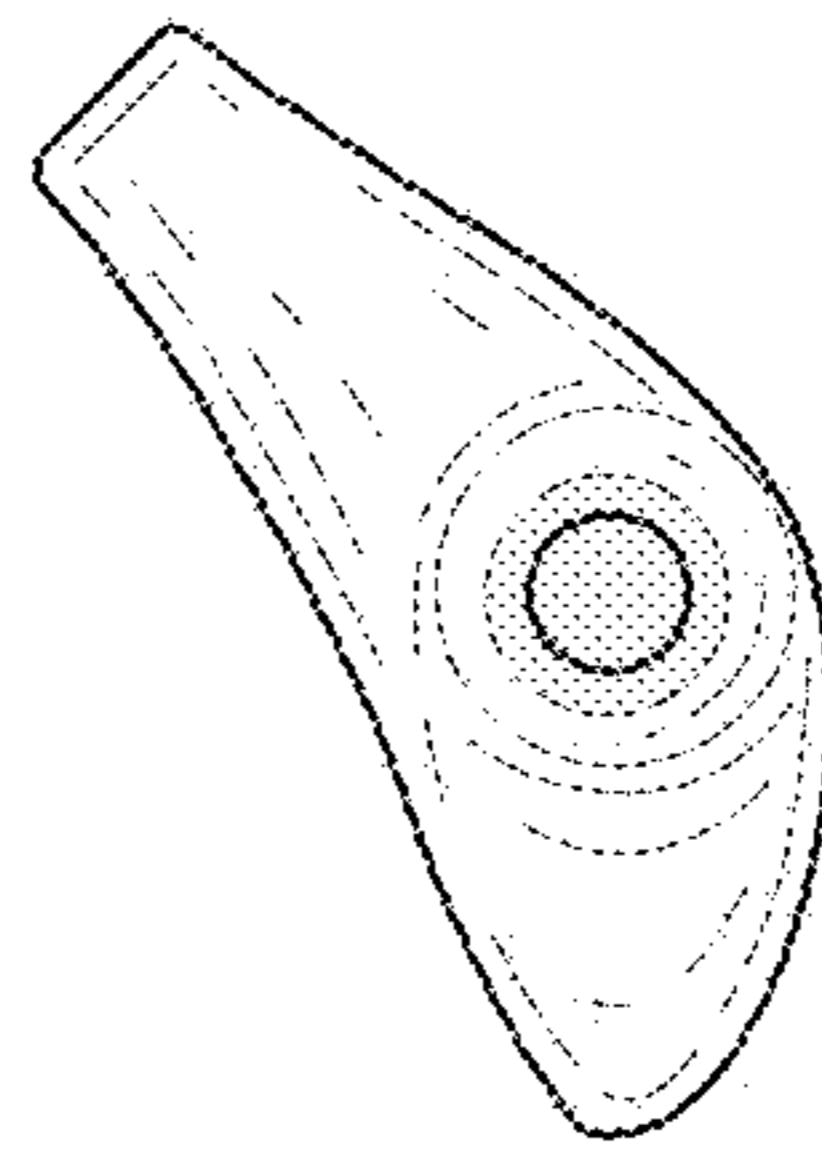

2.5

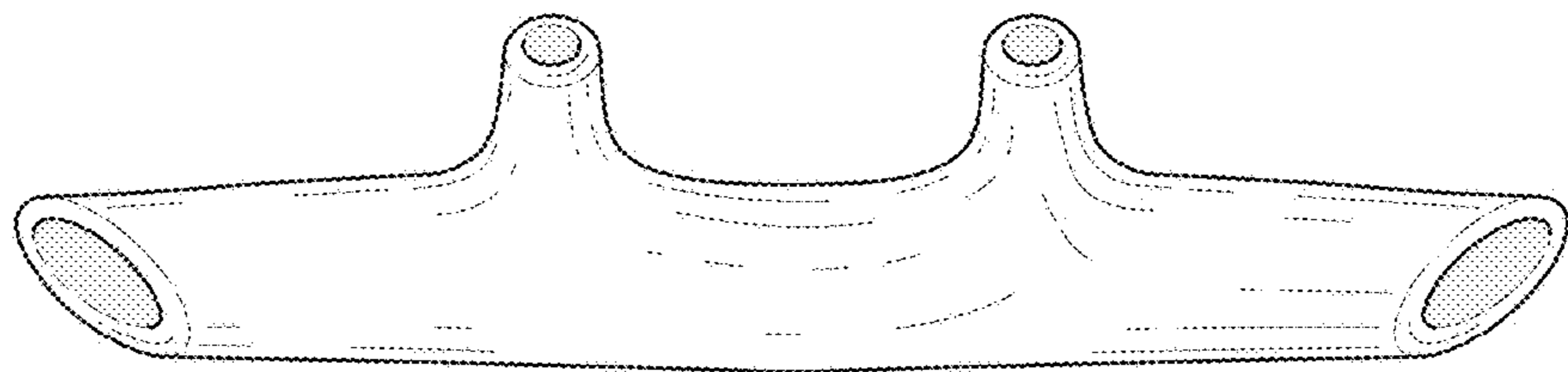

2.6

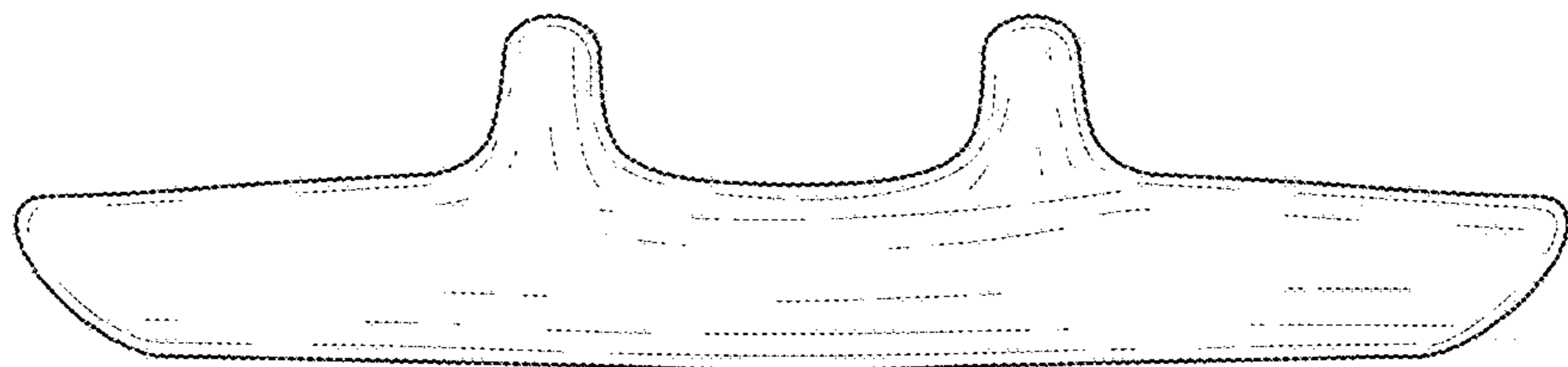

2.7