



US00D859570S

(12) **United States Design Patent**
Geissele

(10) **Patent No.:** **US D859,570 S**

(45) **Date of Patent:** **** Sep. 10, 2019**

(54) **BOLT CATCH FOR A FIREARM**

(71) Applicant: **WHG Properties, LLC**, North Wales,
PA (US)

(72) Inventor: **William H. Geissele**, Lower Gwynedd,
PA (US)

(73) Assignee: **WHG Properties, LLC**, North Wales,
PA (US)

(**) Term: **15 Years**

(21) Appl. No.: **29/624,380**

(22) Filed: **Oct. 31, 2017**

Related U.S. Application Data

(62) Division of application No. 29/563,330, filed on May
4, 2016, now Pat. No. Des. 805,155.

(51) **LOC (12) Cl.** **22-01**

(52) **U.S. Cl.**
USPC **D22/108**

(58) **Field of Classification Search**
USPC D22/103, 108
CPC F41A 3/72; F41A 3/68; F41A 3/26; F41A
3/14

See application file for complete search history.

(56) **References Cited**

U.S. PATENT DOCUMENTS

- 8,327,749 B2 * 12/2012 Underwood F41A 9/59
89/138
- 8,359,966 B1 * 1/2013 Brotherton F41A 17/36
42/70.02
- 8,984,786 B2 * 3/2015 Underwood F41A 9/59
42/18
- 9,429,375 B2 * 8/2016 DeSomma F41A 3/66

- D770,589 S * 11/2016 Underwood F41A 9/59
D22/108
- 9,541,339 B2 * 1/2017 Orne, III F41A 3/72
- 9,551,545 B1 * 1/2017 Rowe F41A 19/06
- D784,478 S * 4/2017 Therrell D22/108
- 9,651,328 B1 * 5/2017 Oglesby F41A 35/06

* cited by examiner

Primary Examiner — Michael A. Pratt

(74) *Attorney, Agent, or Firm* — Fox Rothschild LLP

(57) **CLAIM**

The ornamental design for a bolt catch for a firearm, as
shown and described.

DESCRIPTION

FIG. 1 is a top, front, right side perspective view of a bolt
catch for a firearm in accordance with the present disclosure.
FIG. 2 is a top, front, left side perspective view of the bolt
catch for a firearm of FIG. 1.

FIG. 3 is a front view of the bolt catch for a firearm of FIG.
1.

FIG. 4 is a rear view of the bolt catch for a firearm of FIG.
1.

FIG. 5 is a right side view of the bolt catch for a firearm of
FIG. 1.

FIG. 6 is a left side view of the bolt catch for a firearm of
FIG. 1.

FIG. 7 is a top view of the bolt catch for a firearm of FIG.
1; and,

FIG. 8 is a bottom view of the bolt catch for a firearm of FIG.
1.

The broken lines in the Figures are for illustrative purposes
only and form no part of the claimed design.

1 Claim, 4 Drawing Sheets

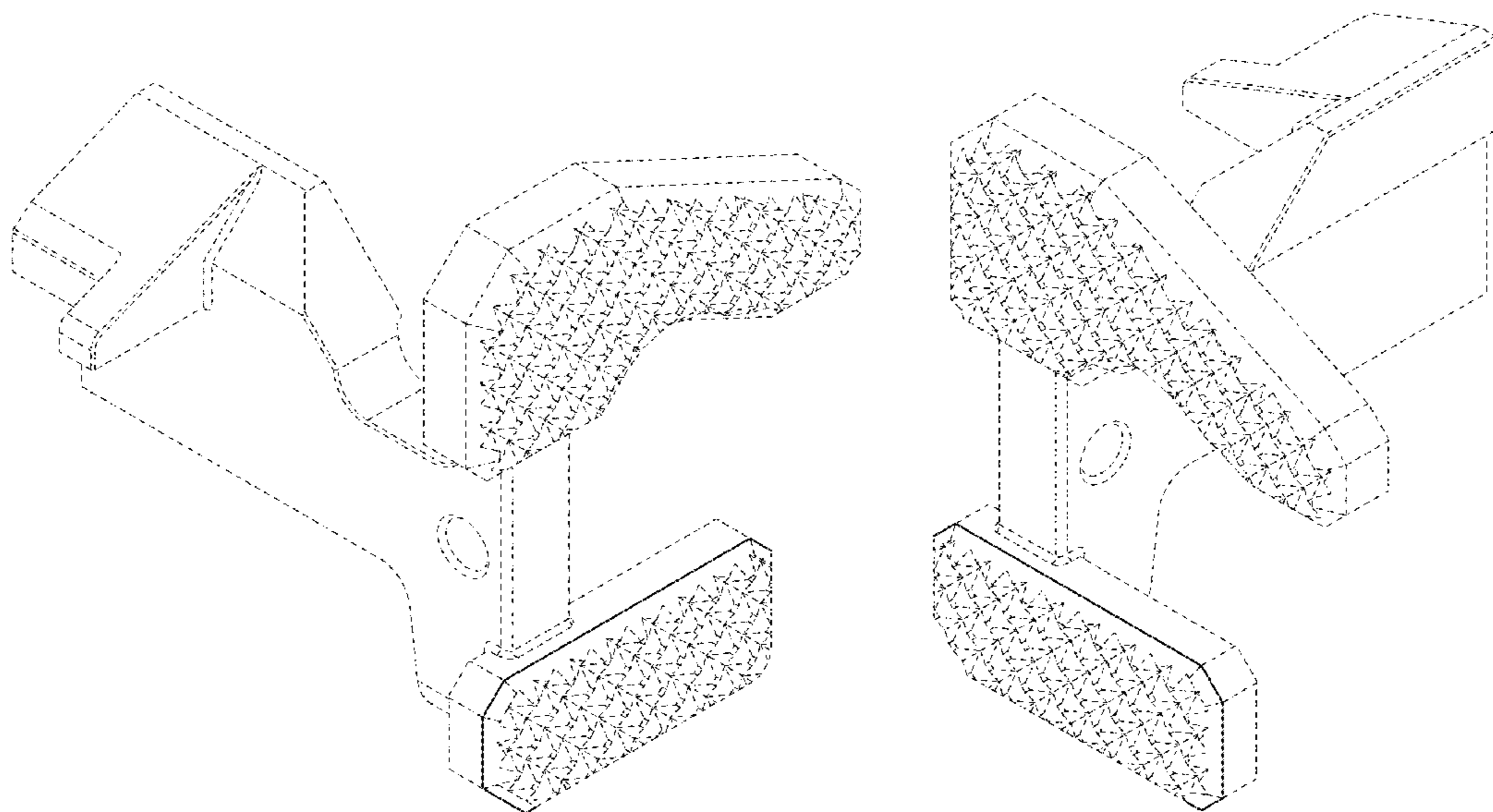

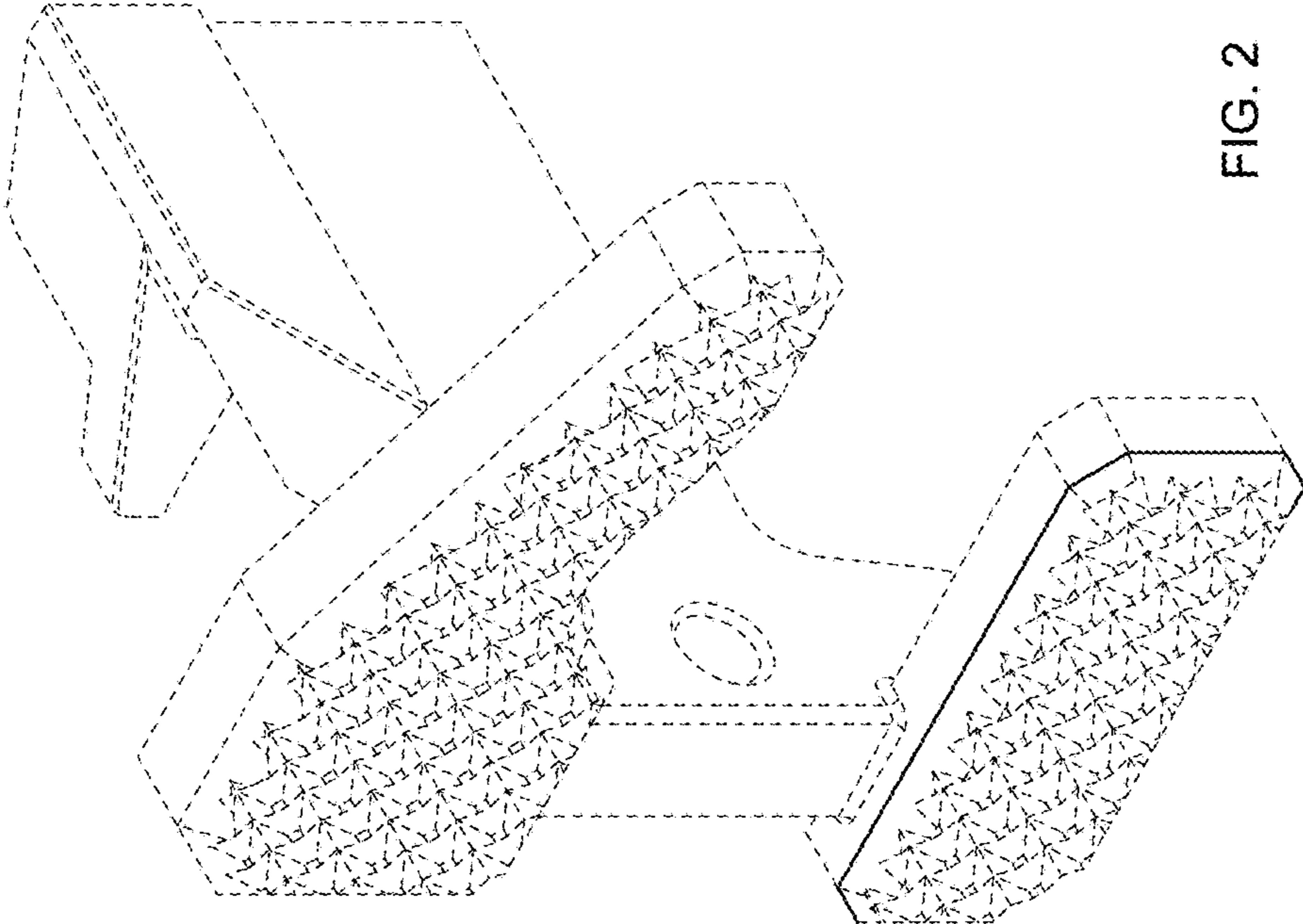

FIG. 2

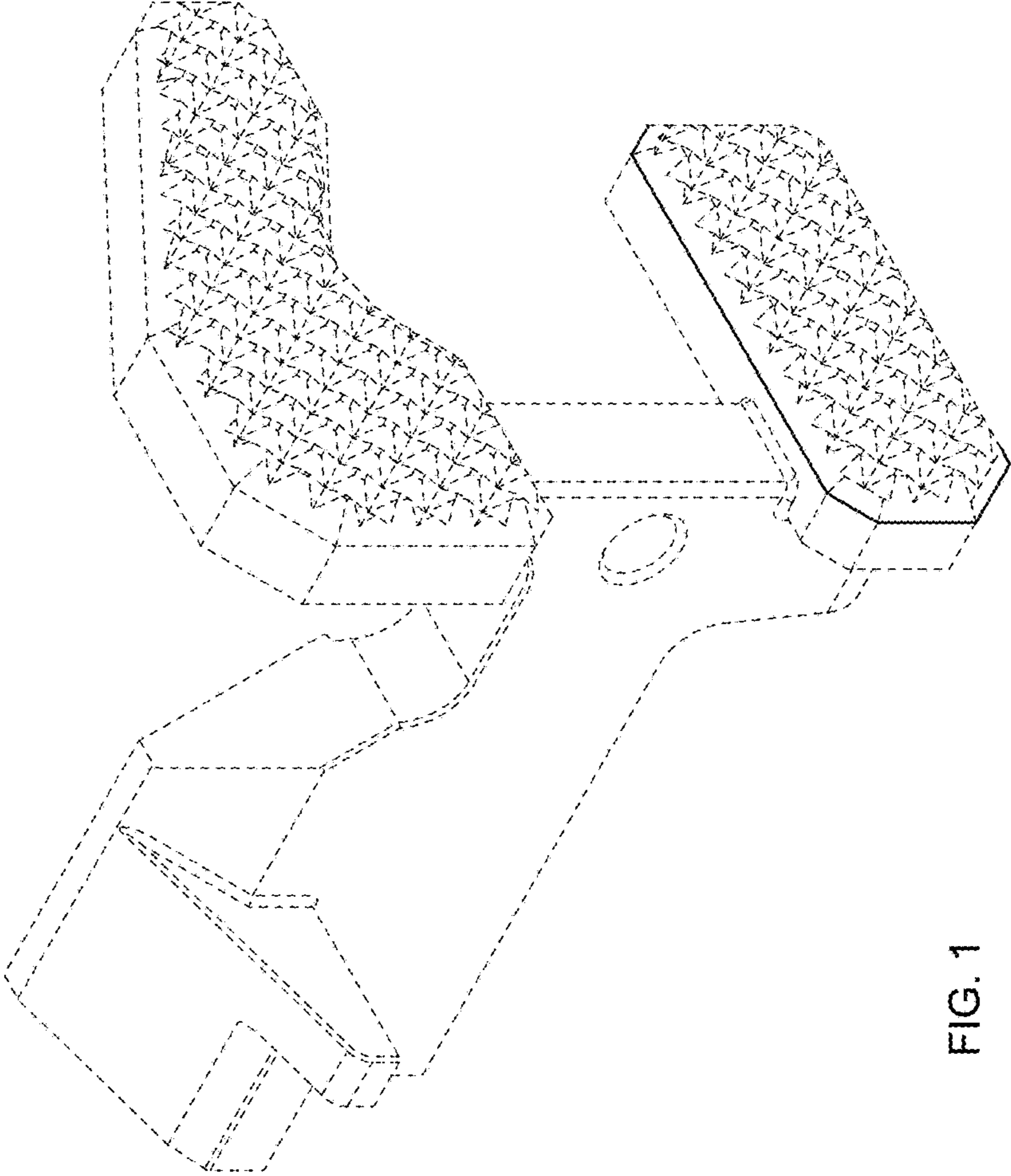

FIG. 1

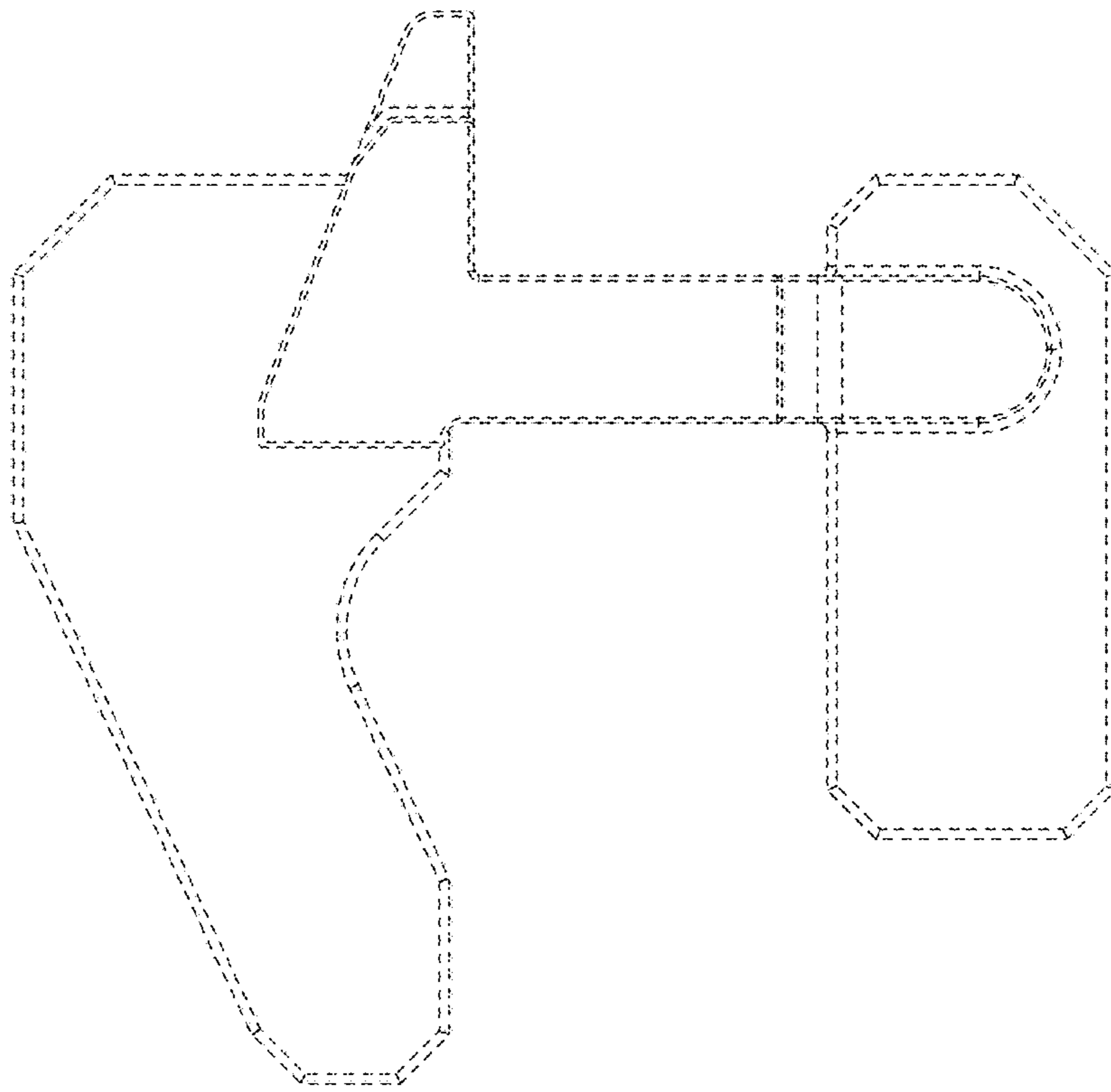

FIG. 4

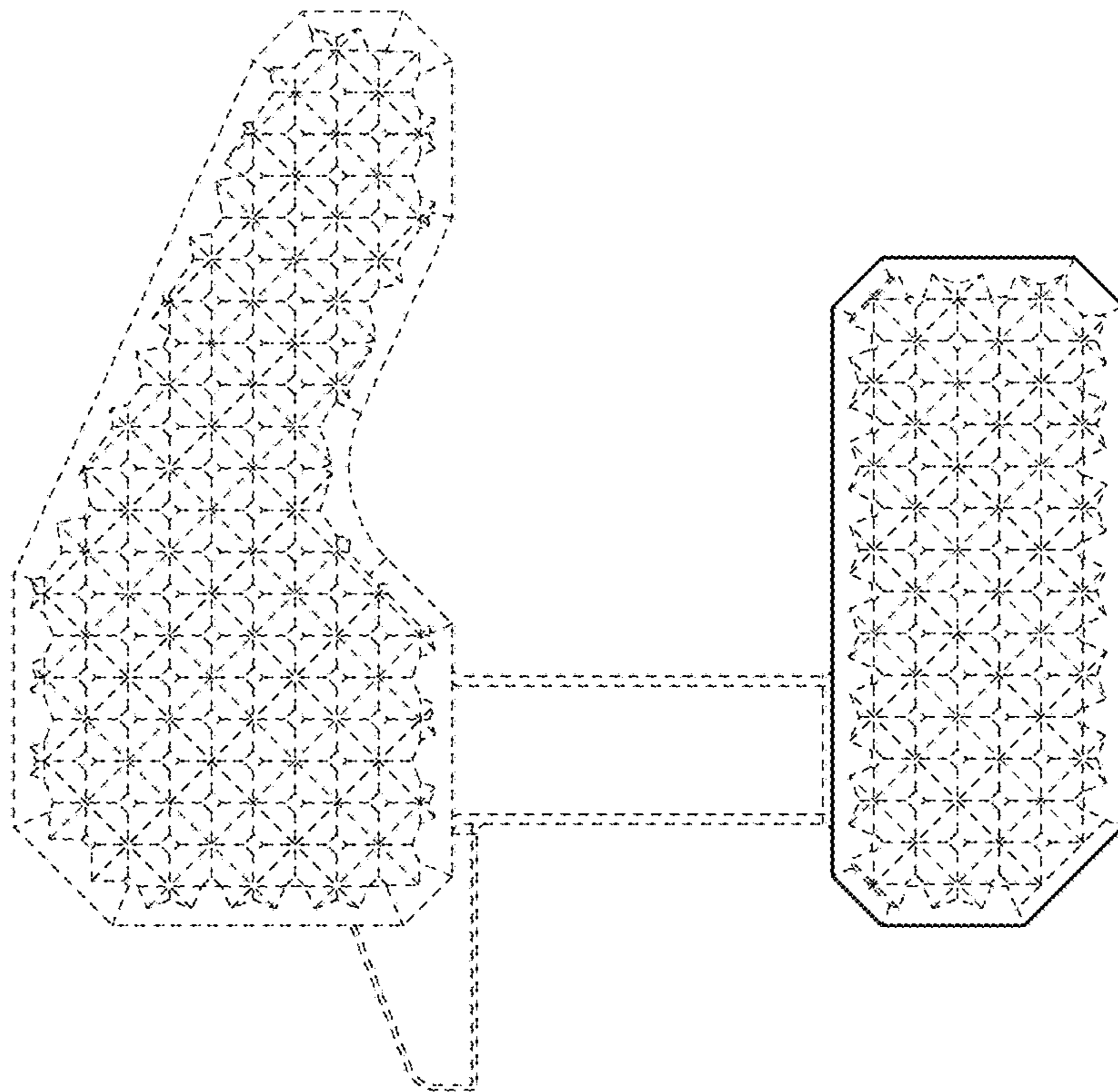

FIG. 3

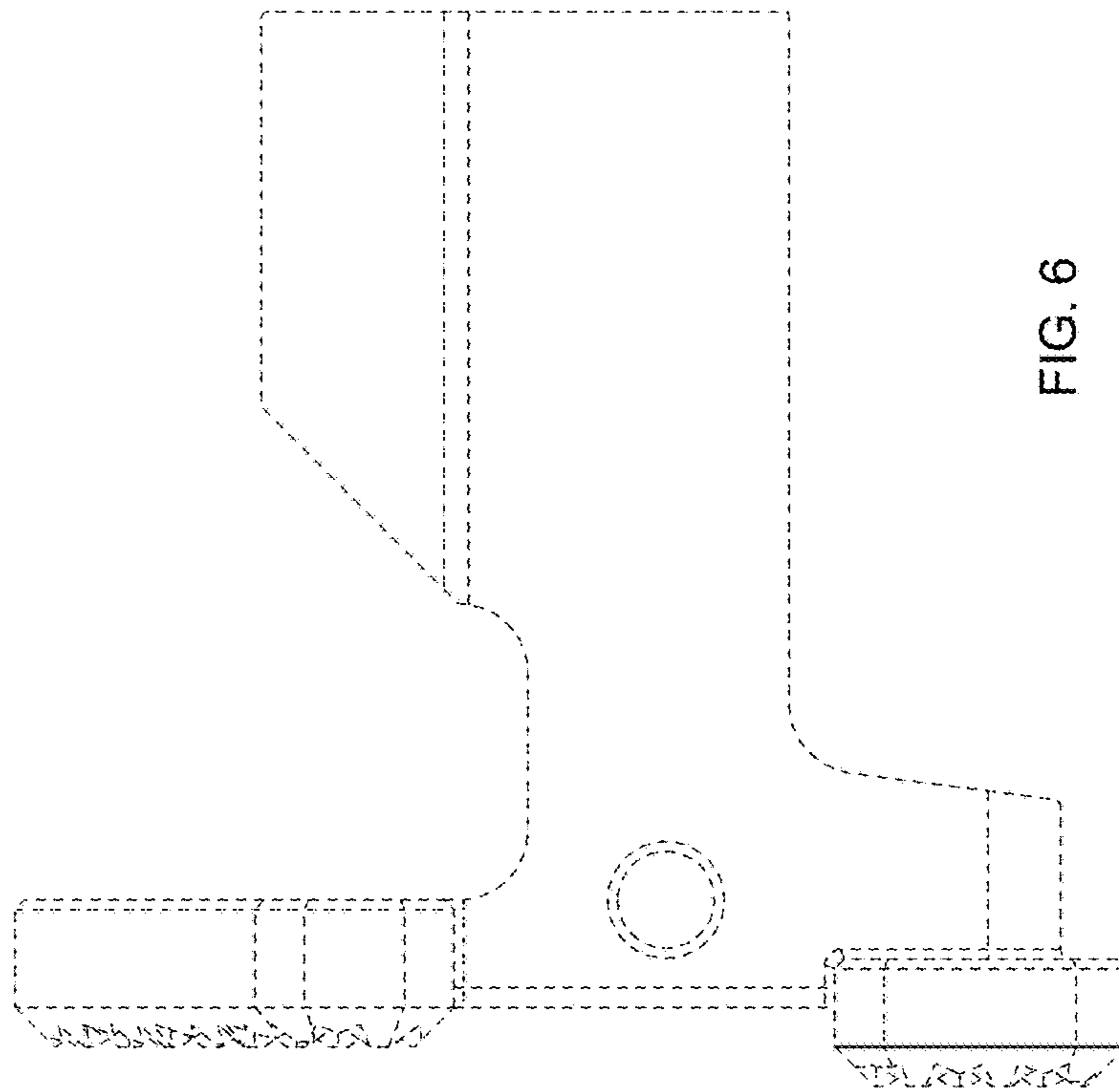

FIG. 6

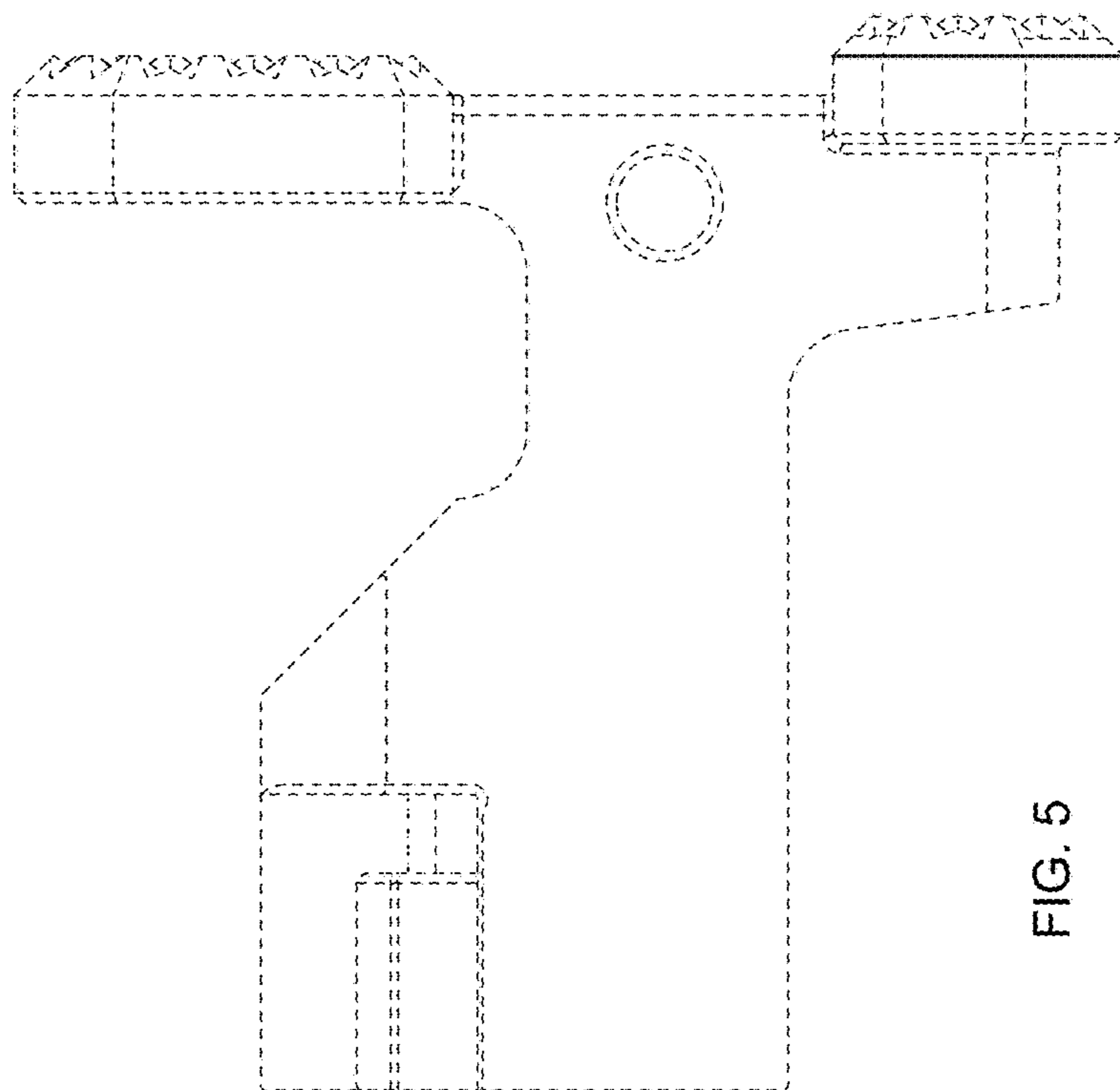

FIG. 5

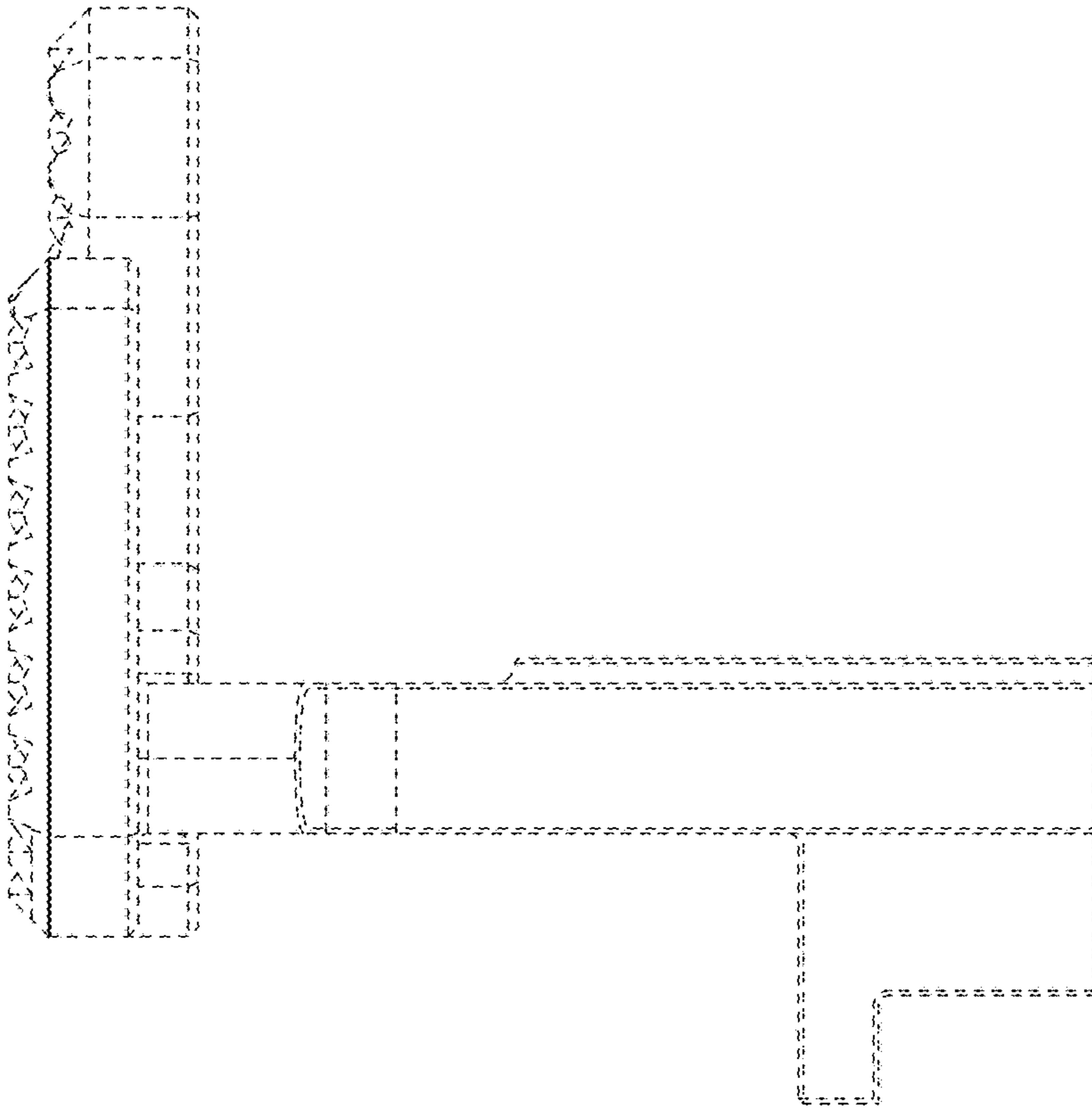

FIG. 7

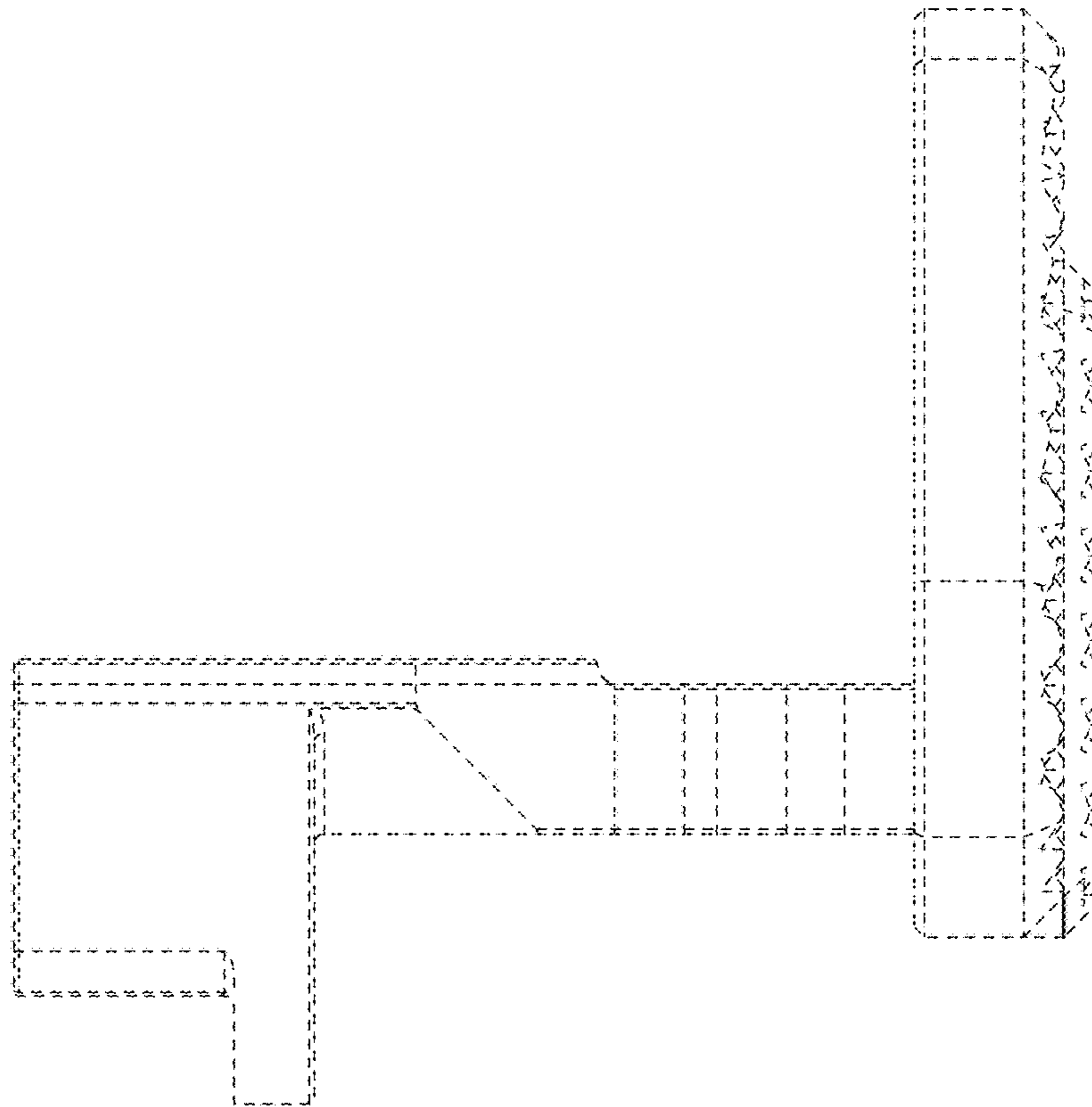

FIG. 8