



US00D859504S

(12) **United States Design Patent**
Saito et al.

(10) **Patent No.:** **US D859,504 S**

(45) **Date of Patent:** **** Sep. 10, 2019**

(54) **PROJECTOR**

(71) Applicant: **Maxell, Ltd.**, Kyoto (JP)

(72) Inventors: **Takeshi Saito**, Kyoto (JP); **Naoto Kubota**, Kyoto (JP)

(73) Assignee: **Maxell, Ltd.**, Kyoto (JP)

(**) Term: **15 Years**

(21) Appl. No.: **29/648,663**

(22) Filed: **May 23, 2018**

(30) **Foreign Application Priority Data**

Nov. 28, 2017 (JP) 2017-026435

(51) **LOC (12) Cl.** **16-02**

(52) **U.S. Cl.**
USPC **D16/230**

(58) **Field of Classification Search**
USPC D16/221, 225, 230–231, 234; D21/514;
353/119
CPC G03B 21/145; G03B 21/14; G03B 21/142;
G03B 21/00; G03B 21/001; G03B
21/003; G03B 21/12; G03B 21/16
See application file for complete search history.

(56) **References Cited**

U.S. PATENT DOCUMENTS

D466,143 S * 11/2002 Torikai D16/230
D475,729 S * 6/2003 Shiota D16/225
7,014,320 B2 * 3/2006 Shiraiishi G03B 21/16
348/748
D577,051 S * 9/2008 Yamamizu D16/225

D627,387 S * 11/2010 Kawaguchi D16/225
D636,426 S * 4/2011 Kawaguchi D16/225
D683,782 S * 6/2013 Ishibashi D16/230
D757,148 S * 5/2016 Amikura D16/230
D774,586 S * 12/2016 Yamamoto D16/225

FOREIGN PATENT DOCUMENTS

CN 304806701 * 5/2018

* cited by examiner

Primary Examiner — Wan Laymon

(74) *Attorney, Agent, or Firm* — Mattingly & Malur, PC

(57) **CLAIM**

The ornamental design for a projector, as shown and described.

DESCRIPTION

FIG. 1 is a front, top and left side perspective view of a projector showing our new design; FIG. 2 is a rear, top and right side perspective view thereof; FIG. 3 is a front elevational view thereof; FIG. 4 is a top plan view thereof; FIG. 5 is a right side elevational view thereof; FIG. 6 is a left side elevational view thereof; FIG. 7 is a rear elevational view thereof; FIG. 8 is a bottom plan view thereof; and, FIG. 9 is a cross-sectional view take along line 9-9 in FIG. 3.

The broken lines shown in the drawings represent portions of the projector that form no part of the claimed design.

1 Claim, 4 Drawing Sheets

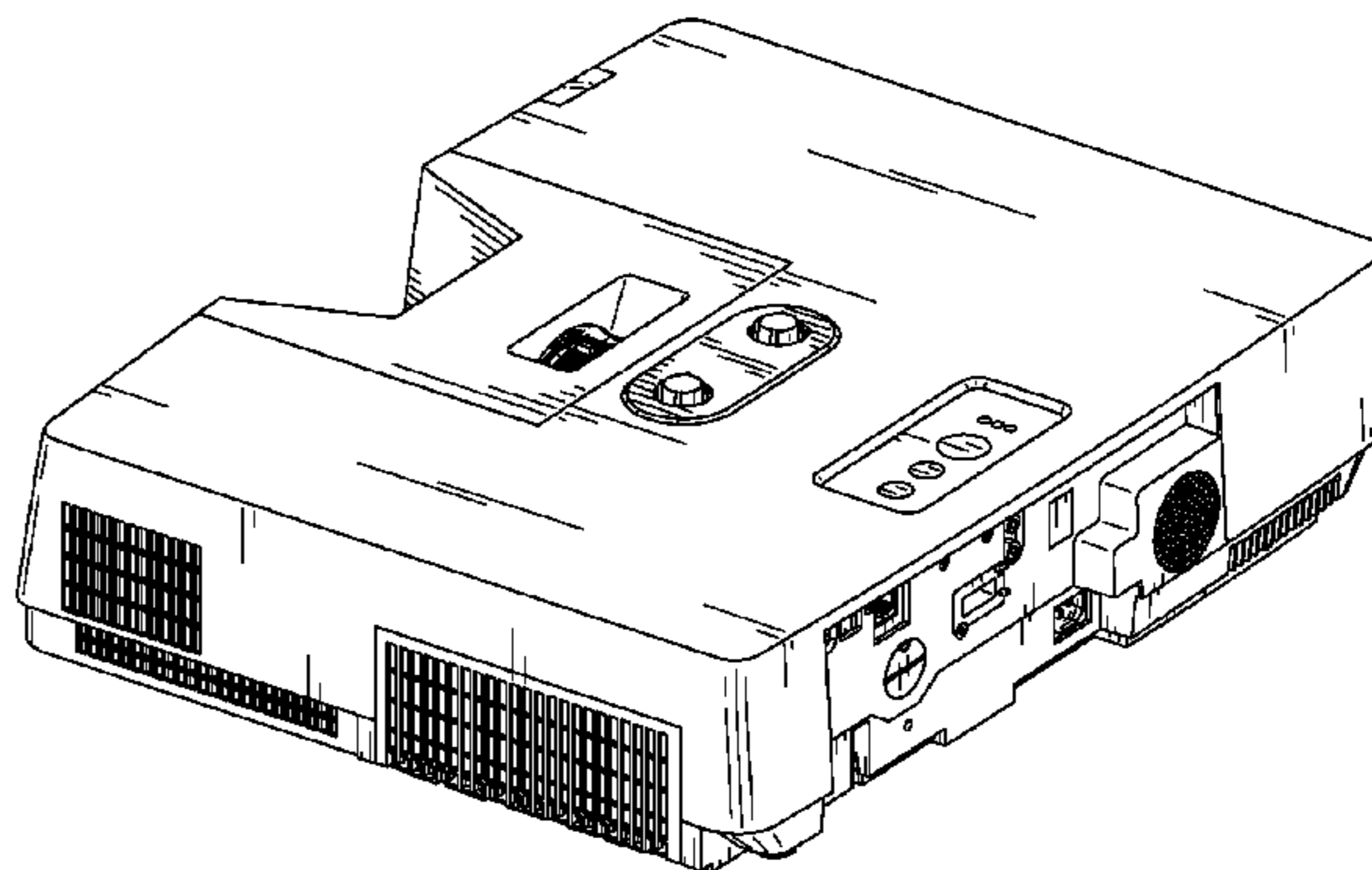
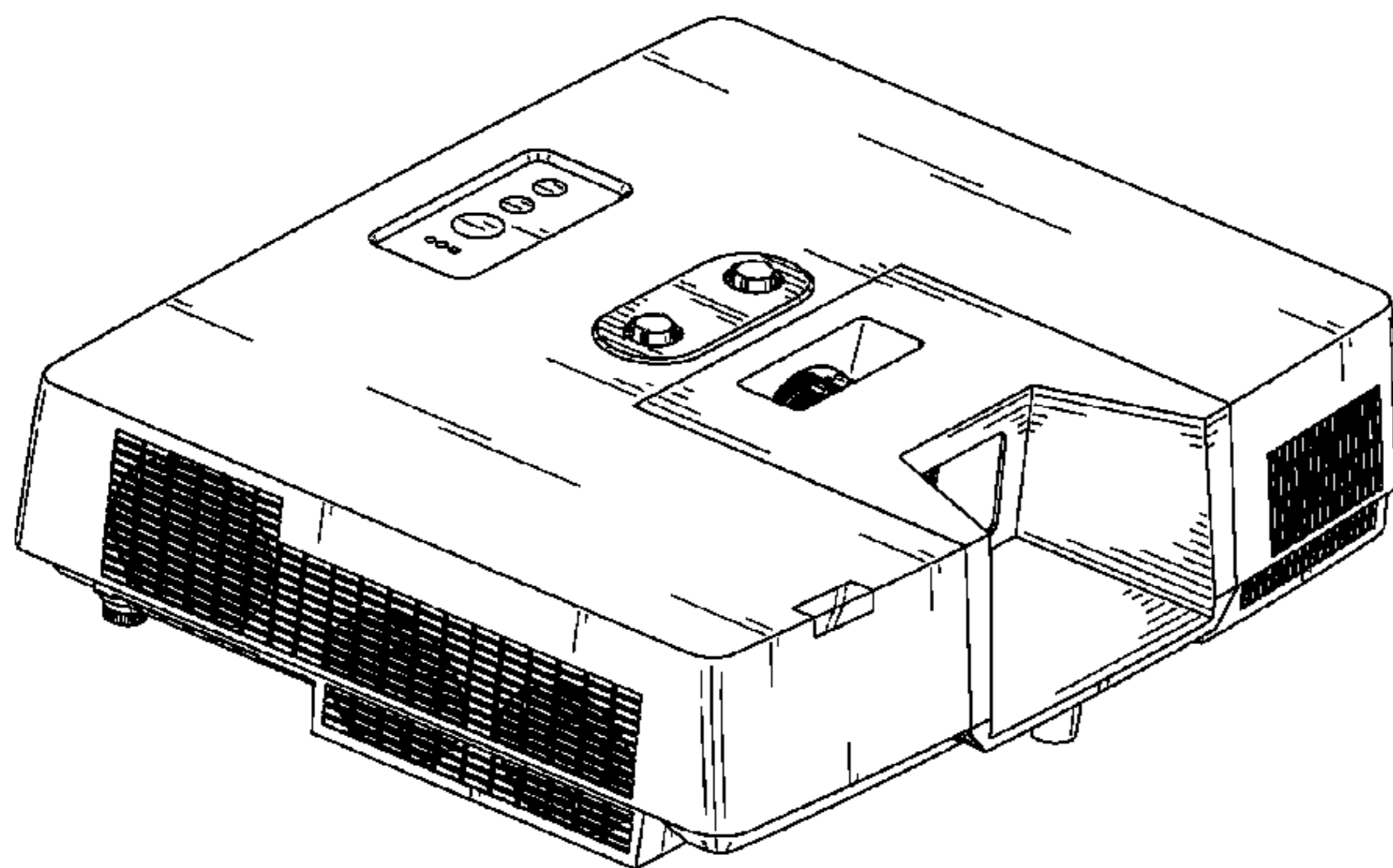

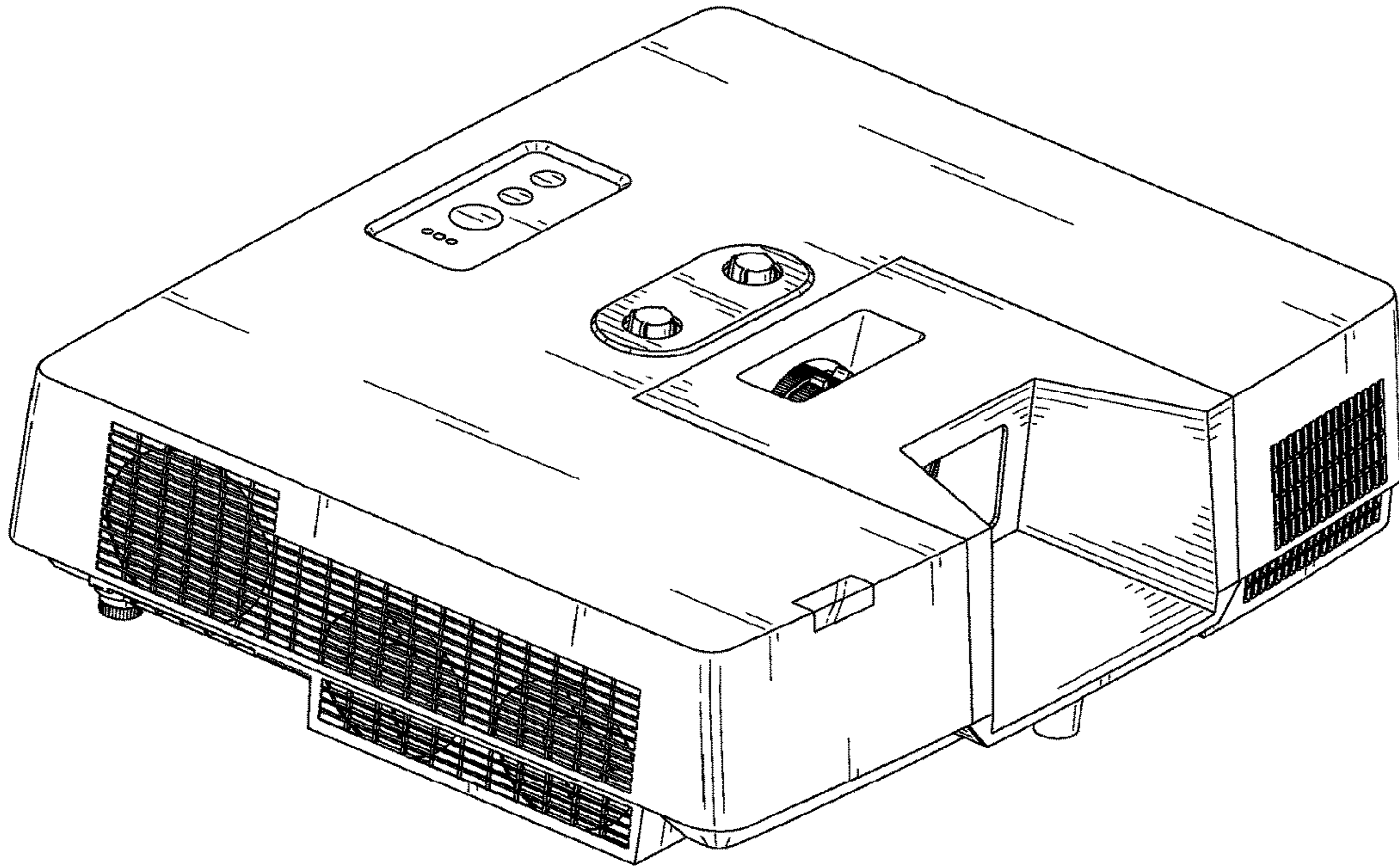

FIG. 1

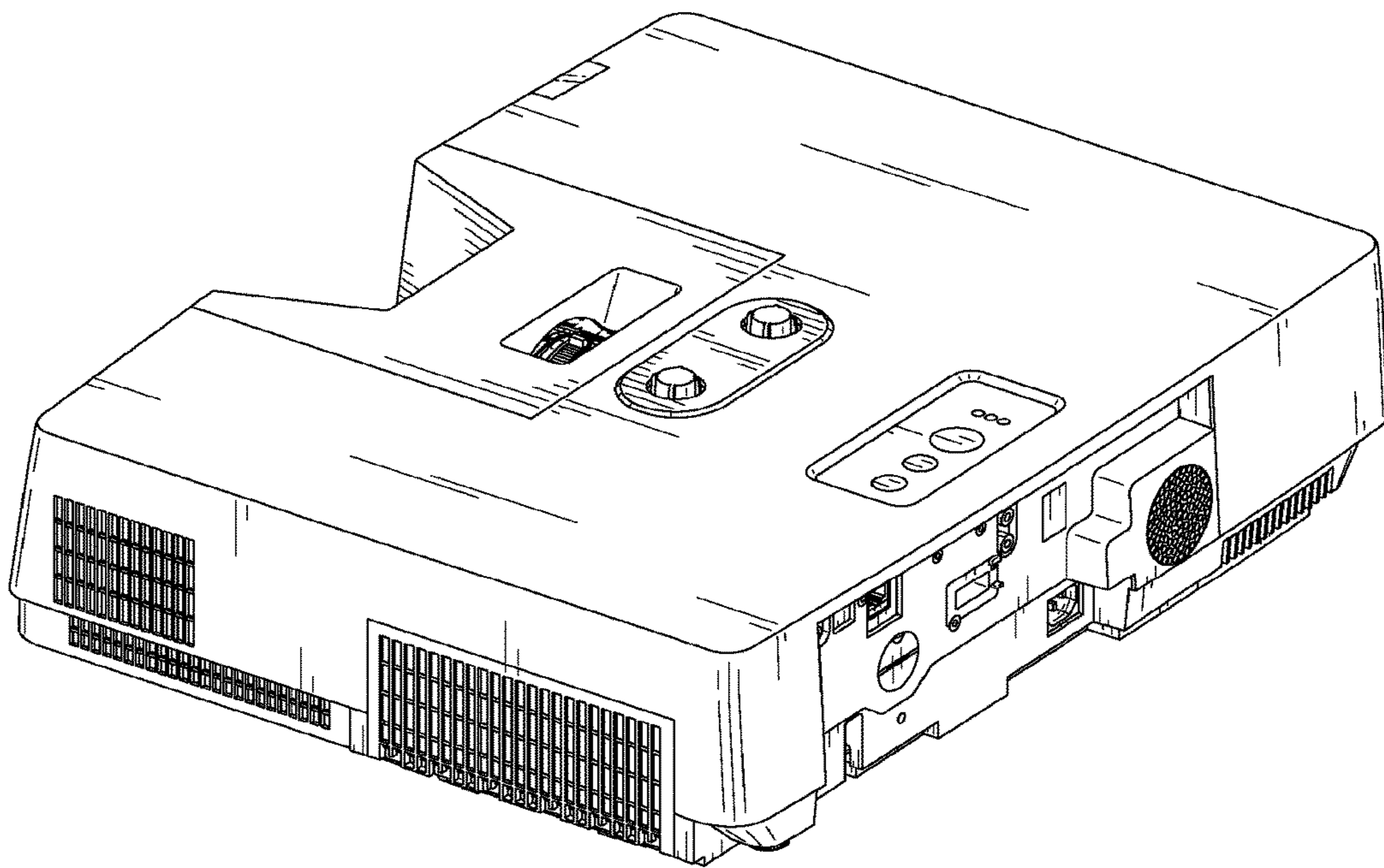

FIG. 2

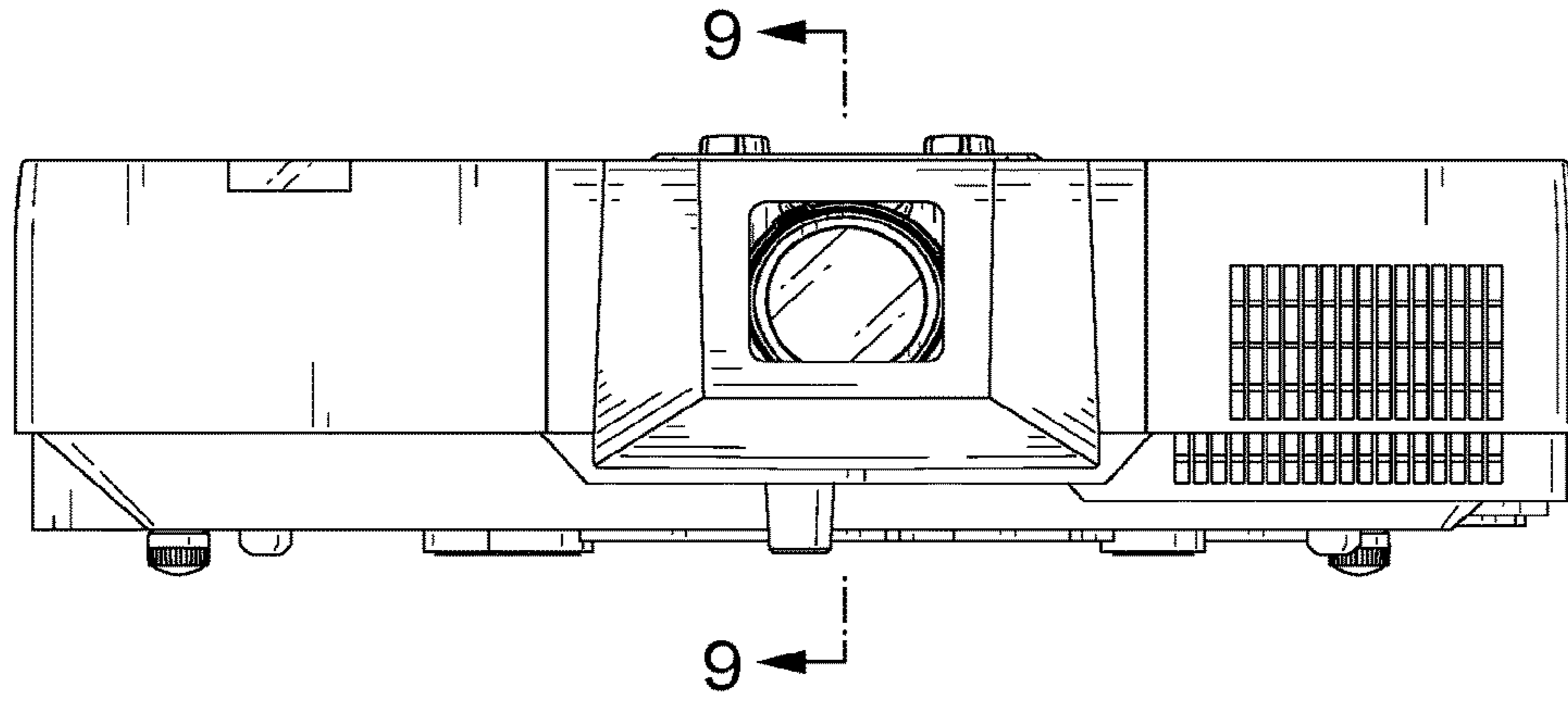

FIG. 3

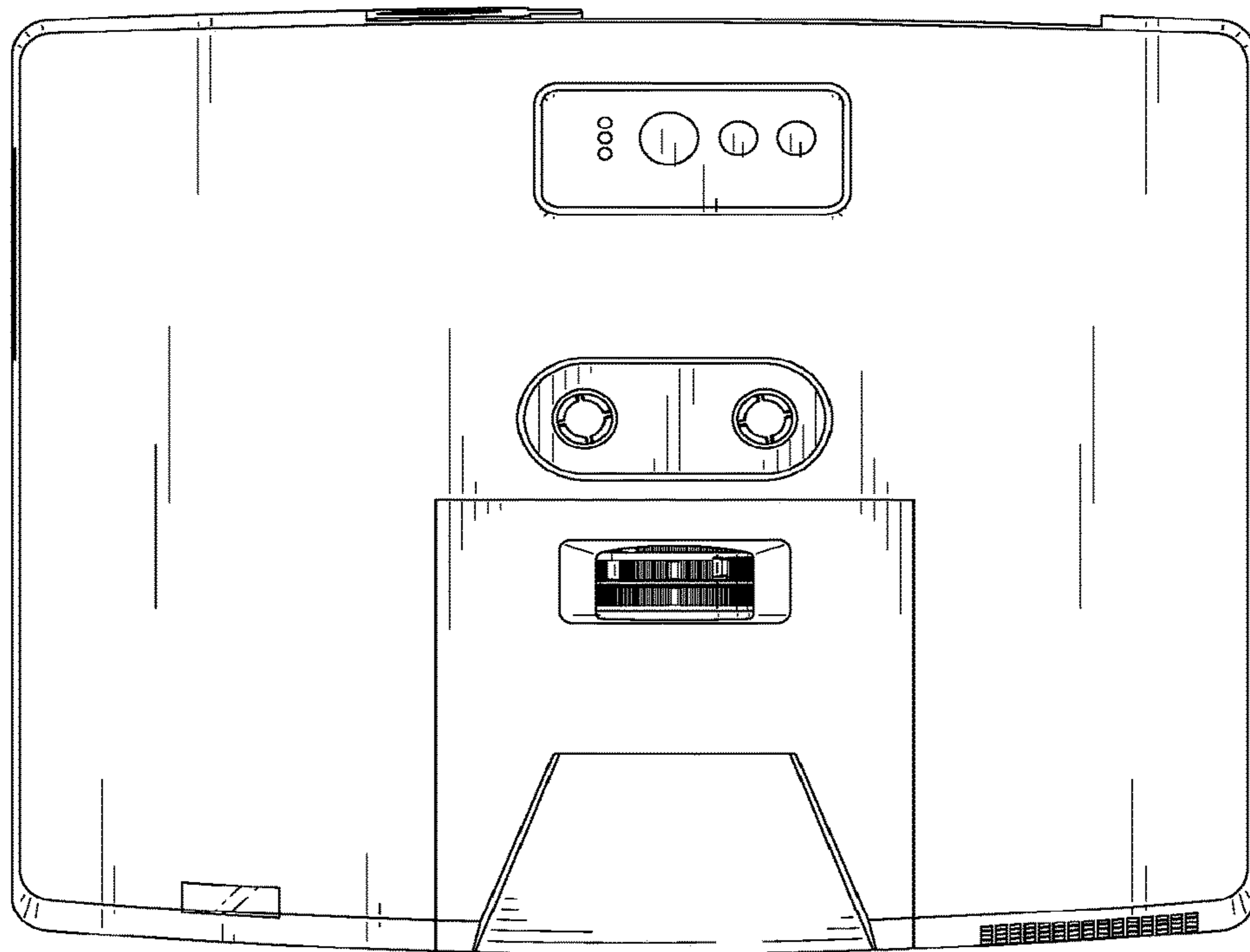

FIG. 4

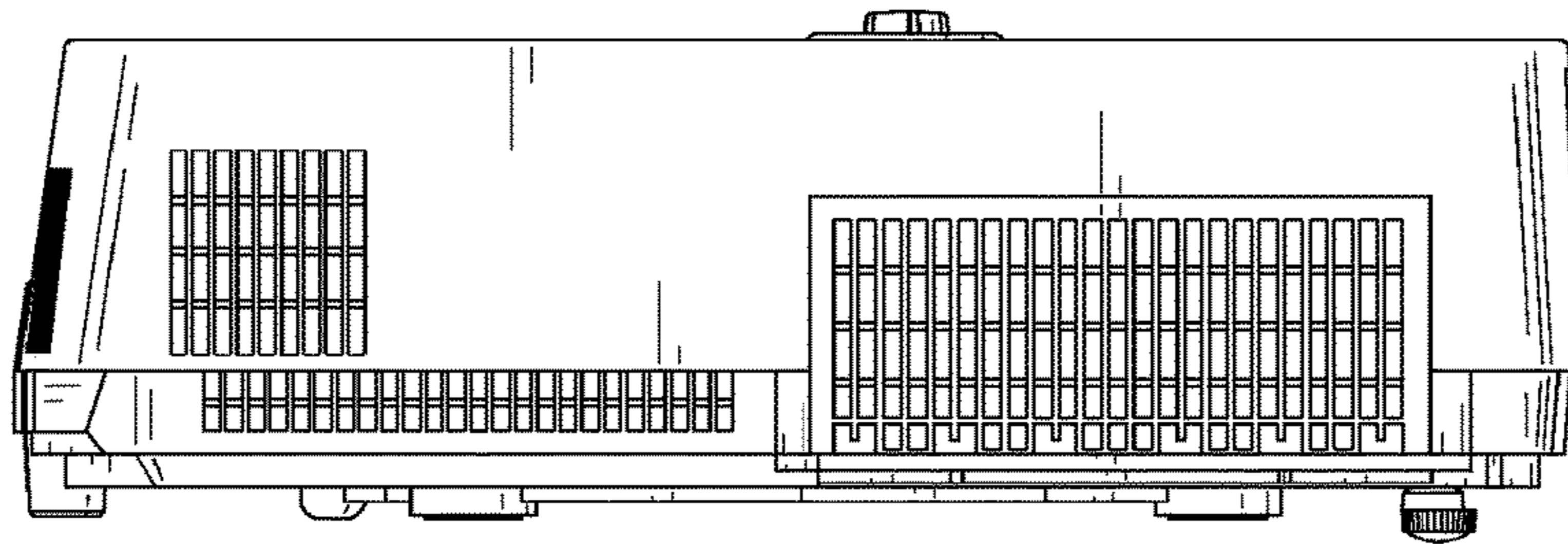

FIG. 5

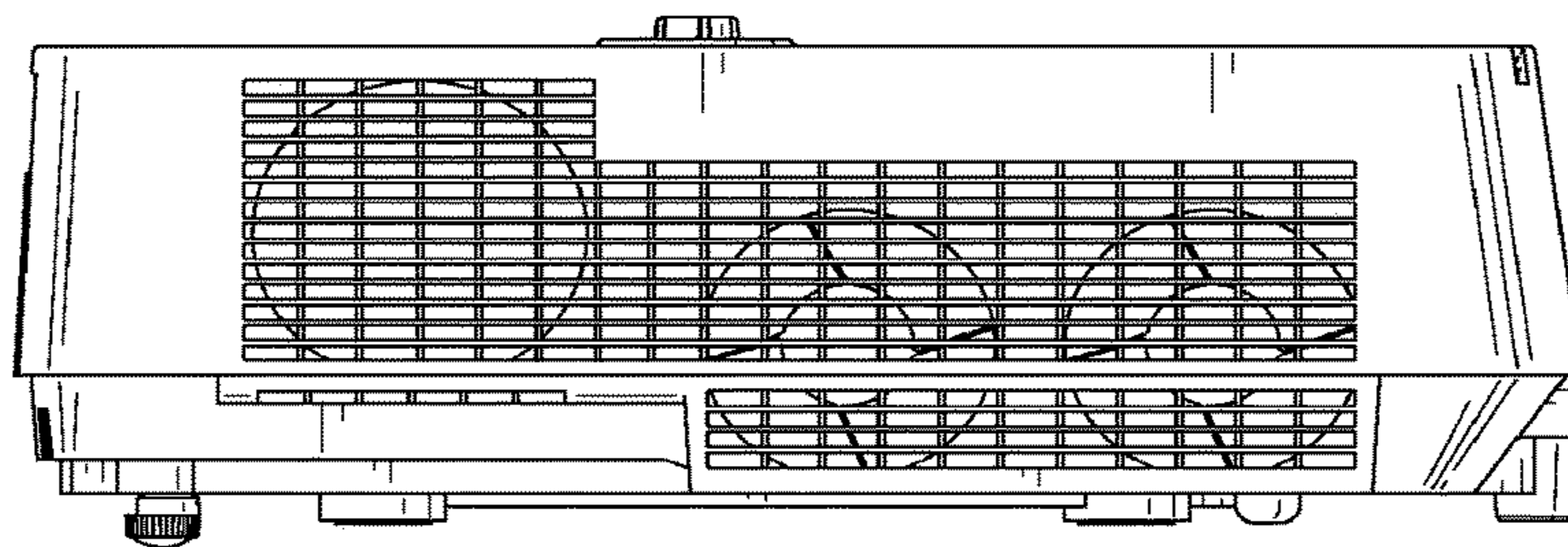

FIG. 6

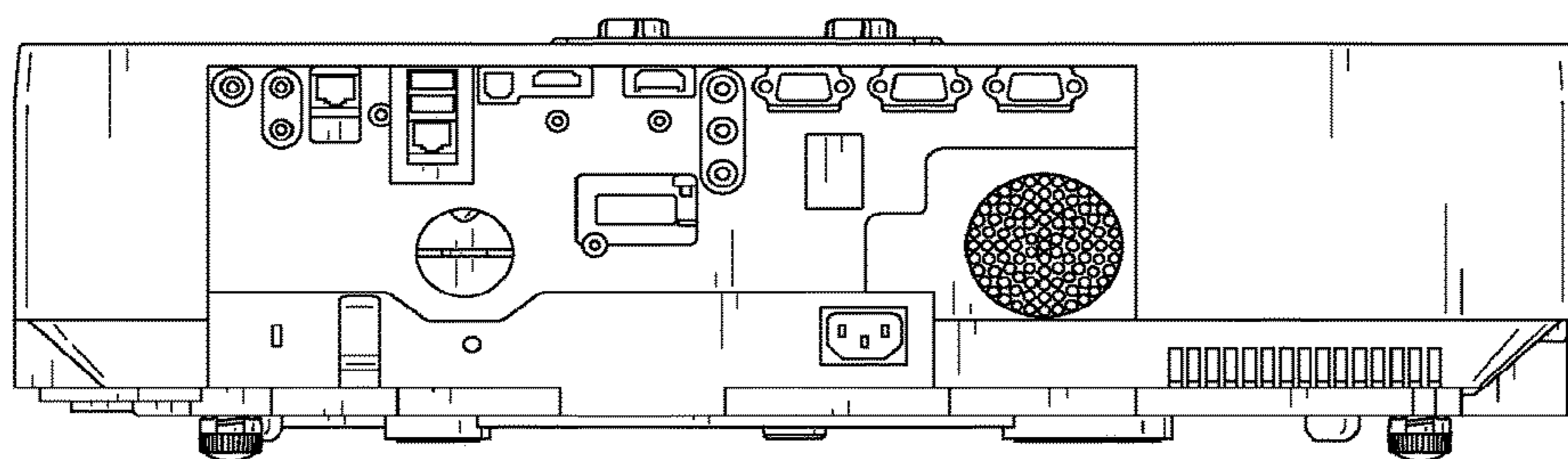

FIG. 7

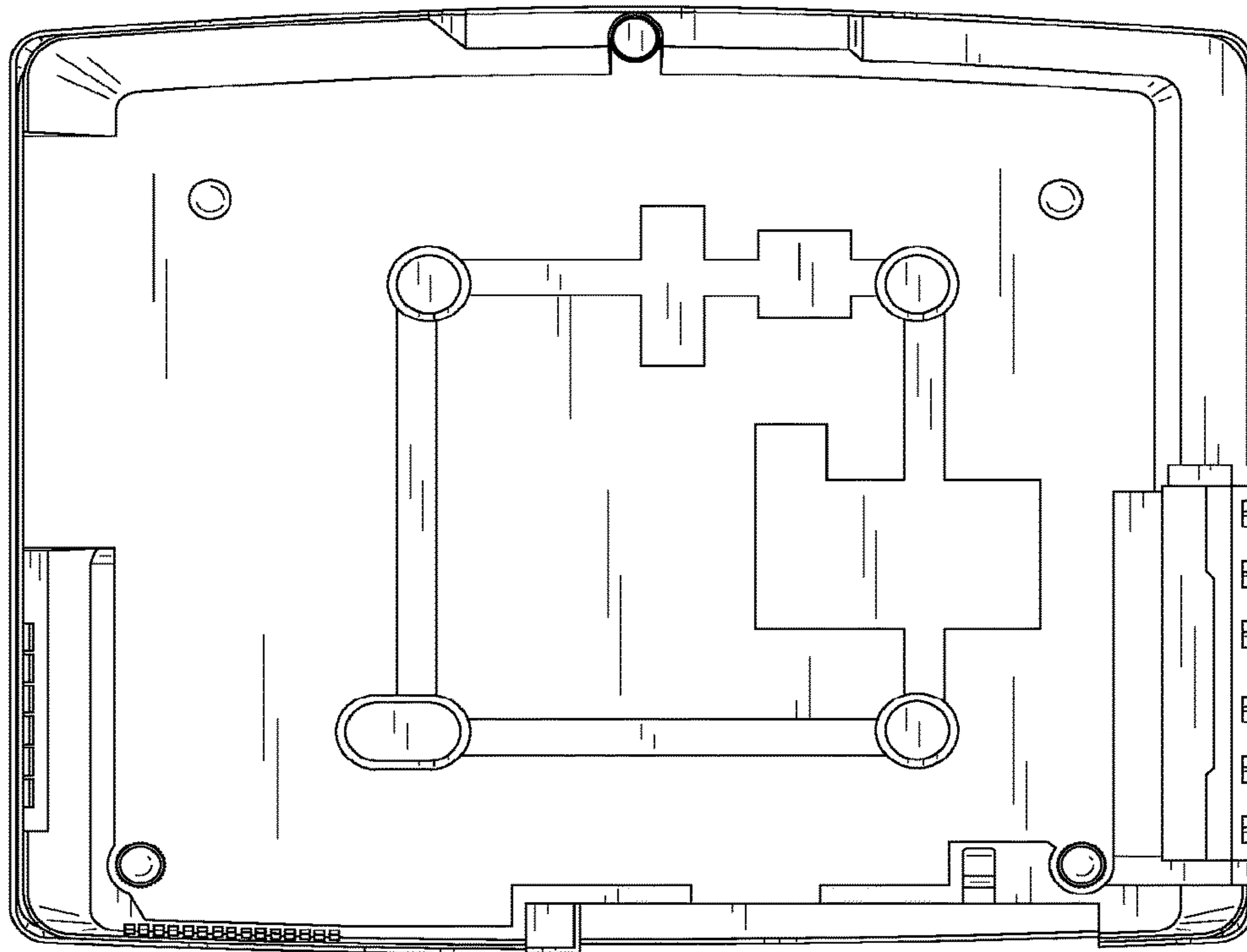

FIG. 8

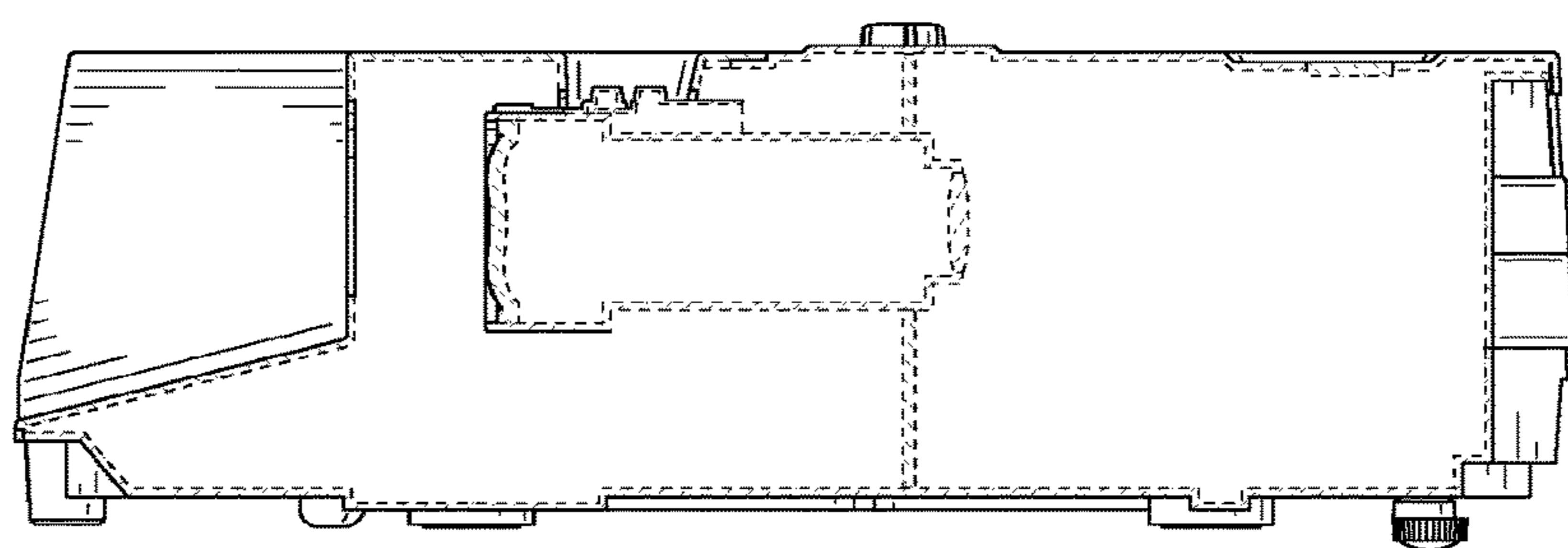

FIG. 9