



US00D859278S

(12) **United States Design Patent** (10) **Patent No.:** **US D859,278 S**  
**White** (45) **Date of Patent:** **\*\* Sep. 10, 2019**

(54) **WHEEL CHOCK**

(71) Applicant: **Richard White**, San Antonio, TX (US)

(72) Inventor: **Richard White**, San Antonio, TX (US)

(\*\*) Term: **15 Years**

(21) Appl. No.: **29/649,565**

(22) Filed: **May 31, 2018**

(51) **LOC (12) Cl.** ..... **12-16**

(52) **U.S. Cl.**  
USPC ..... **D12/217**

(58) **Field of Classification Search**  
USPC ..... D12/217, 400, 223; D34/32, 38;  
D25/113; D8/354

See application file for complete search history.

(56) **References Cited**

**U.S. PATENT DOCUMENTS**

2,720,285	A	10/1955	Taylor	
D206,447	S *	12/1966	Switzer	D12/217
D389,796	S *	1/1998	Olson	D12/217
5,913,389	A	6/1999	Clark	
6,336,527	B1	1/2002	Metz	
6,390,245	B1	5/2002	Metz	
6,467,586	B2	10/2002	Agtuca	
7,121,508	B2 *	10/2006	Fulcher	B64F 1/16 244/111
D552,527	S *	10/2007	Wolfram	D12/217
7,753,177	B2	7/2010	Slager	
8,657,078	B2 *	2/2014	Wolfram	B60T 3/00 188/36

D772,775	S *	11/2016	Bird	D12/223
D775,579	S *	1/2017	Hughes	D12/217
2011/0100765	A1	5/2011	Bird et al.	

**OTHER PUBLICATIONS**

<https://www.amazon.com/Vestil-RWC-8-ERGO-Rubber-Handle-Height/dp/B0052PS2I0>, May 31, 2018.

<https://backcountrypilot.org/forum/light-weight-chocks-12095>, May 31, 2018.

<https://www.chocks.com/product/hgsysp>; May 31, 2018.

\* cited by examiner

*Primary Examiner* — Stacia A Cadmus

(74) *Attorney, Agent, or Firm* — Brandon T. Cook; Gunn, Lee & Cave, P.C.

(57) **CLAIM**

The ornamental design for a wheel chock, as shown and described.

**DESCRIPTION**

FIG. 1 is a front view of a wheel chock showing my new design;

FIG. 2 is a rear view thereof;

FIG. 3 is a left side view thereof;

FIG. 4 is a right side view thereof;

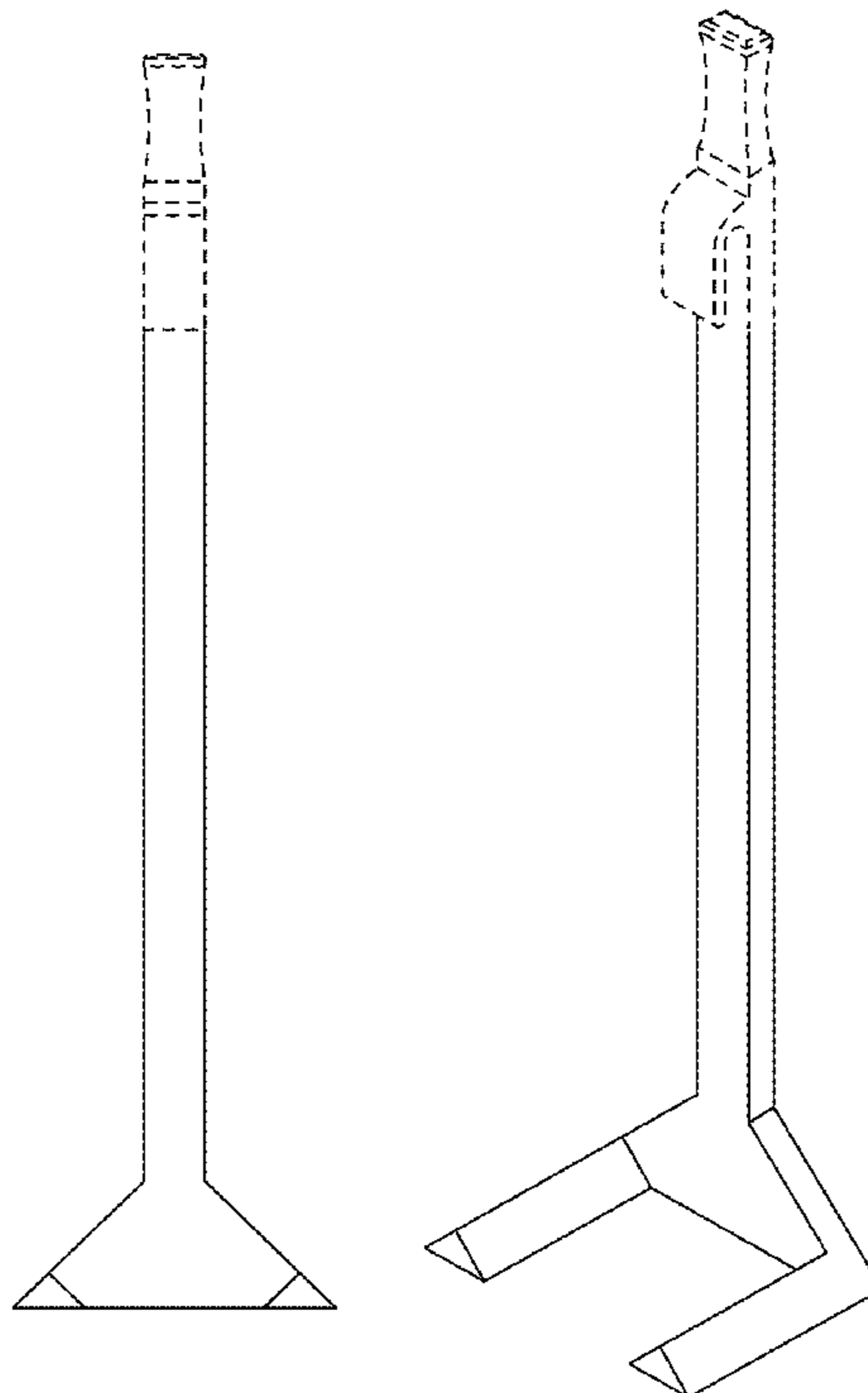
FIG. 5 is a top view thereof;

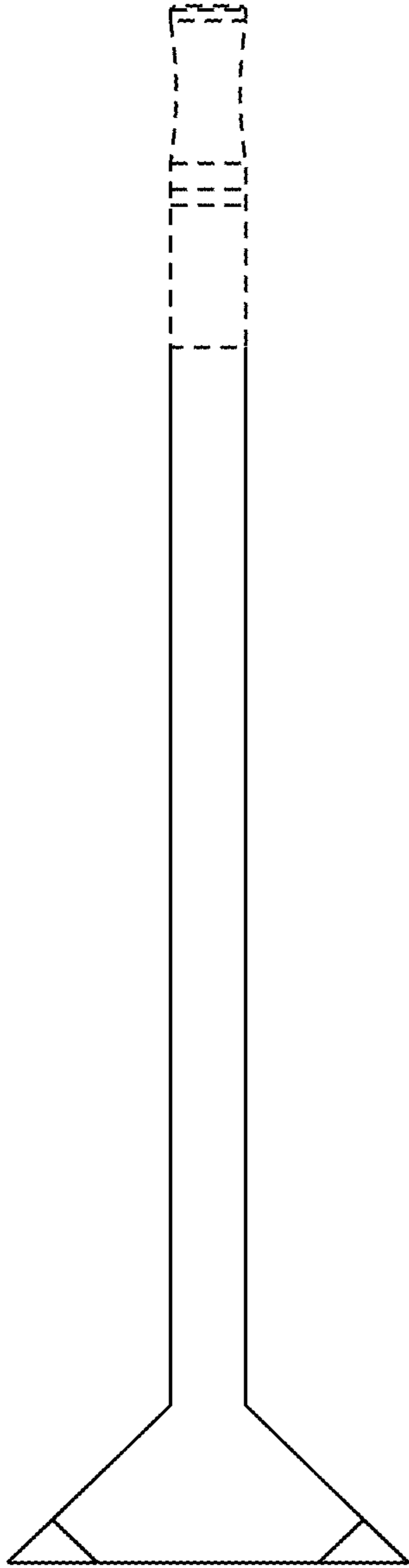
FIG. 6 is a bottom view thereof; and,

FIG. 7 is a perspective view thereof.

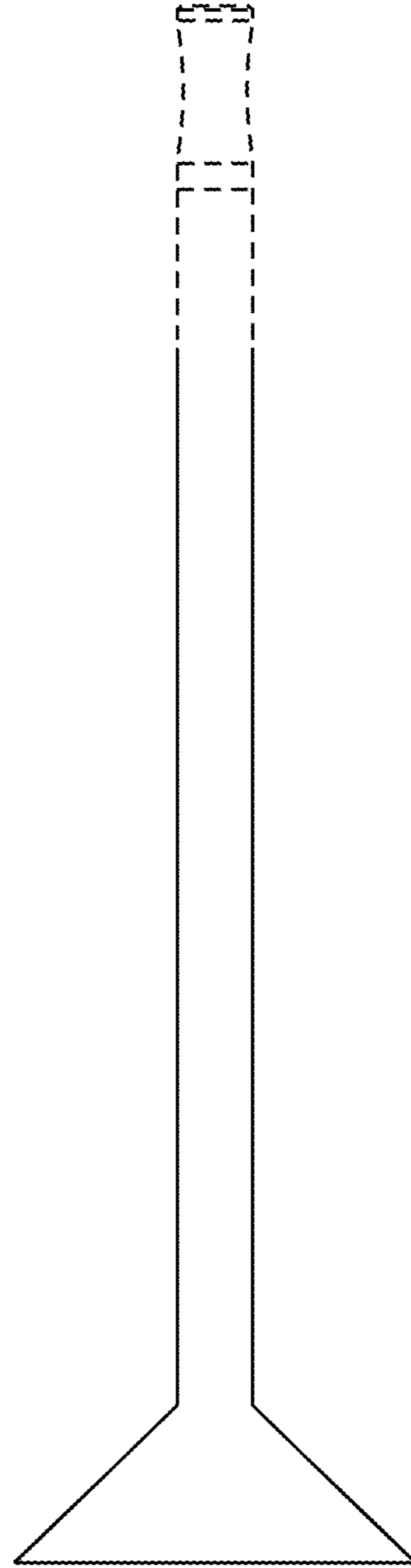
The broken lines represent unclaimed subject matter and form no part of the claimed design.

**1 Claim, 3 Drawing Sheets**

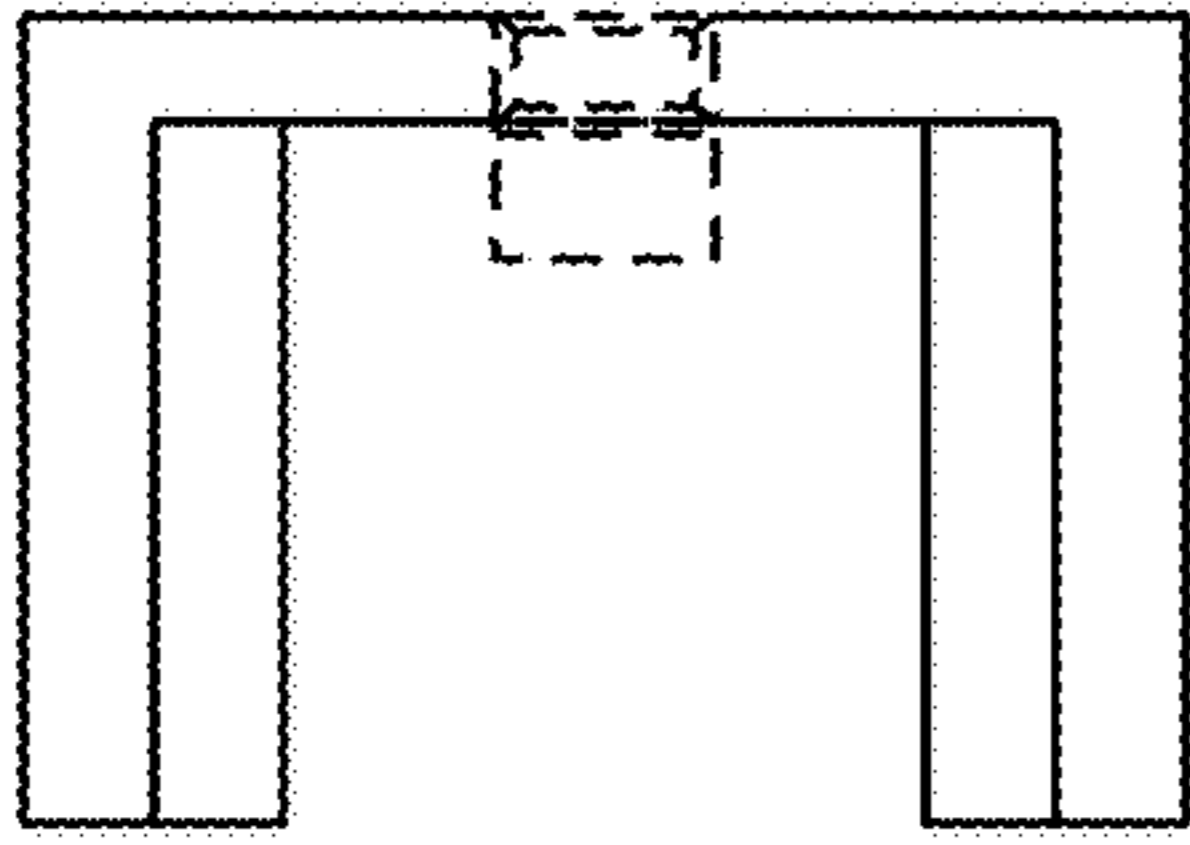




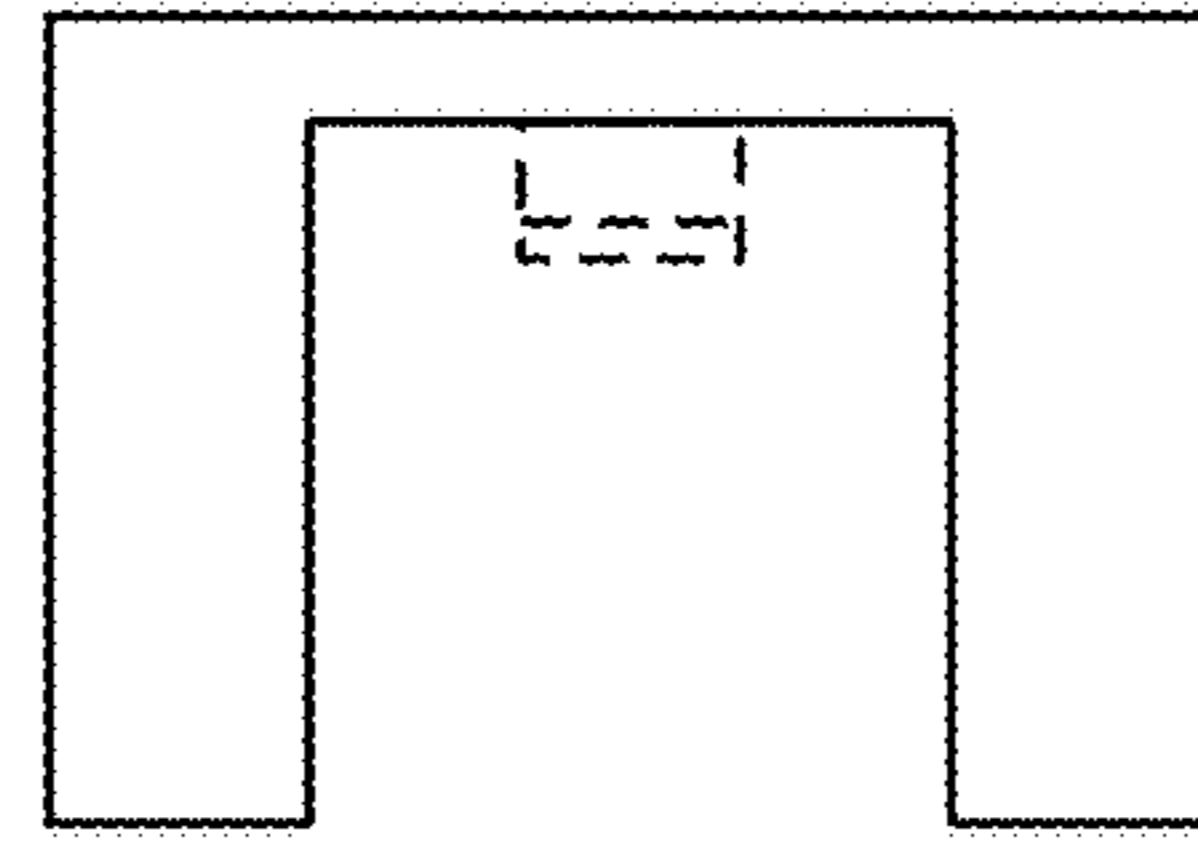
**FIG. 1**



**FIG. 2**



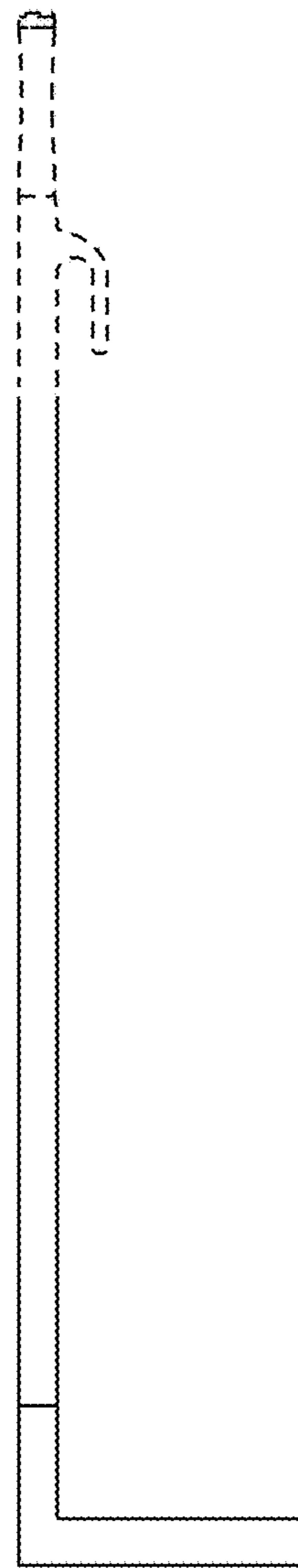
**FIG. 5**



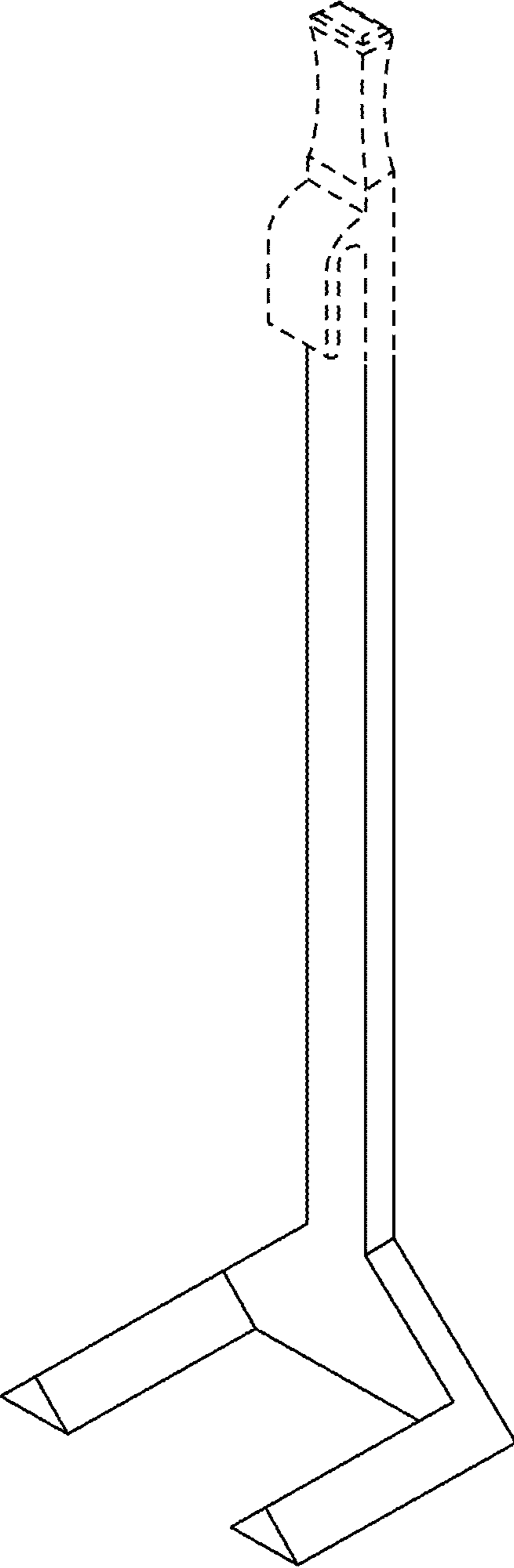
**FIG. 6**



**FIG. 3**



**FIG. 4**



**FIG. 7**