



US00D859094S

(12) **United States Design Patent**
Umholtz et al.

(10) **Patent No.:** **US D859,094 S**
(45) **Date of Patent:** **** Sep. 10, 2019**

(54) **VEGETABLE PEELER**

(71) Applicants: **Mason Adam Umholtz**, Brooklyn, NY (US); **Terah Coleman**, Brooklyn, NY (US)

(72) Inventors: **Mason Adam Umholtz**, Brooklyn, NY (US); **Terah Coleman**, Brooklyn, NY (US)

(73) Assignee: **HELEN OF TROY LIMITED**, St. Michael (BB)

(**) Term: **15 Years**

(21) Appl. No.: **29/644,175**

(22) Filed: **Apr. 16, 2018**

(51) **LOC (12) Cl.** **07-04**

(52) **U.S. Cl.**
USPC **D7/695**

(58) **Field of Classification Search**
USPC D7/680-696, 393, 395, 669, 368
CPC .. A47J 17/02; A47J 17/04; A47J 17/06; A47J 17/08; A47J 17/00; A47J 43/00; A47J 43/288; B26D 1/03
See application file for complete search history.

(56) **References Cited**

U.S. PATENT DOCUMENTS

D609,537 S * 2/2010 Kestenbaum D7/695
D674,253 S * 1/2013 Spiegel D7/695

D674,254 S * 1/2013 Spiegel D7/695
D675,890 S * 2/2013 Reay D7/695
2004/0117991 A1* 6/2004 Haberstroh A47J 17/02 30/279.6
2007/0227013 A1* 10/2007 Kaposi A47J 17/02 30/279.6
2015/0075012 A1* 3/2015 Opinel A47J 17/02 30/295

* cited by examiner

Primary Examiner — Terry A Wallace

(57) **CLAIM**

The ornamental design for a vegetable peeler, as shown, and described.

DESCRIPTION

FIG. 1 is a perspective view of the vegetable peeler; FIG. 2 is a front elevation view thereof; FIG. 3 is a rear elevation view thereof; FIG. 4 is a right side view thereof; FIG. 5 is a left side view thereof; FIG. 6 is a top view thereof; and, FIG. 7 is a bottom view thereof. The broken lines represent unclaimed features and form no part of the claimed design.

1 Claim, 7 Drawing Sheets

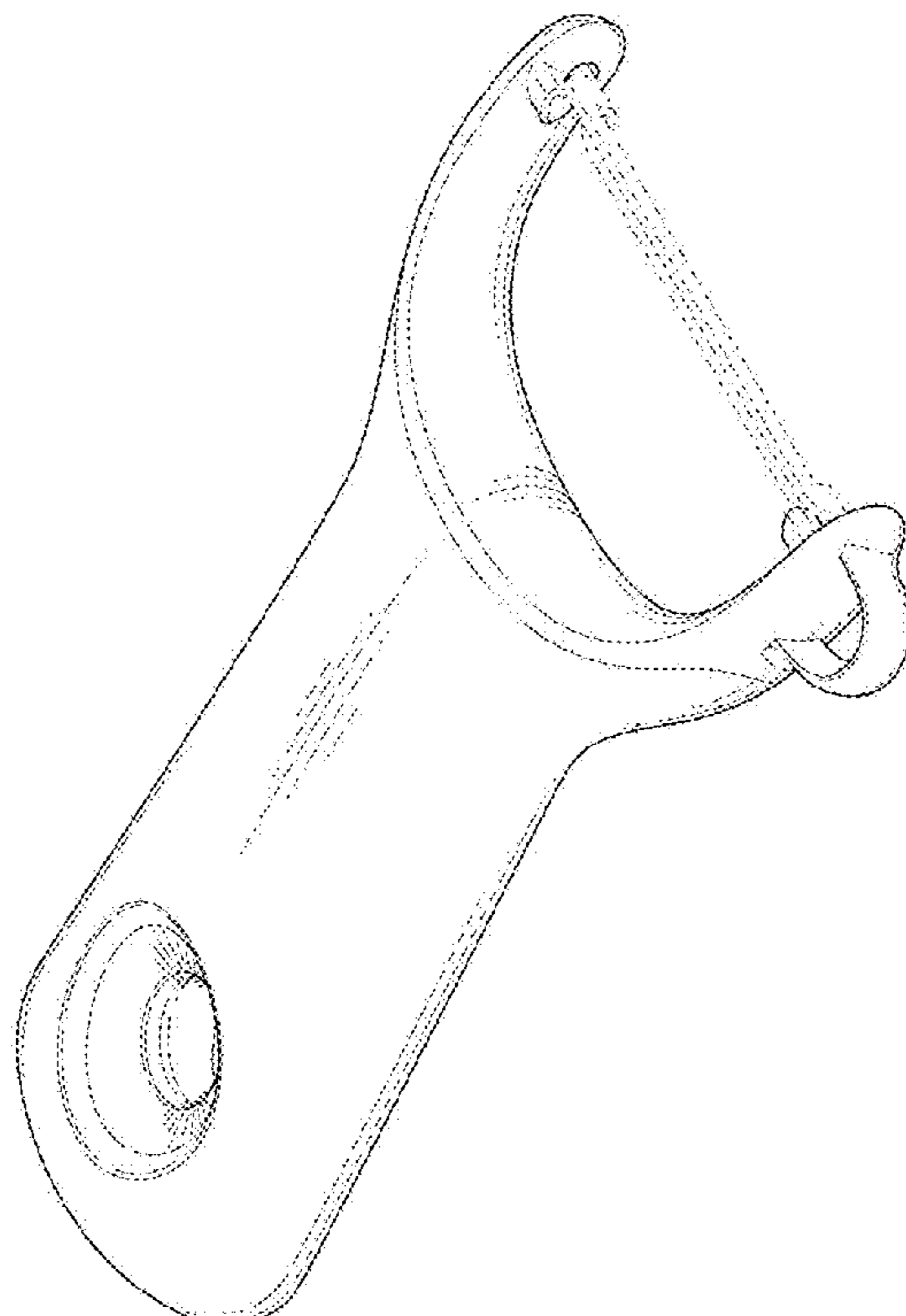

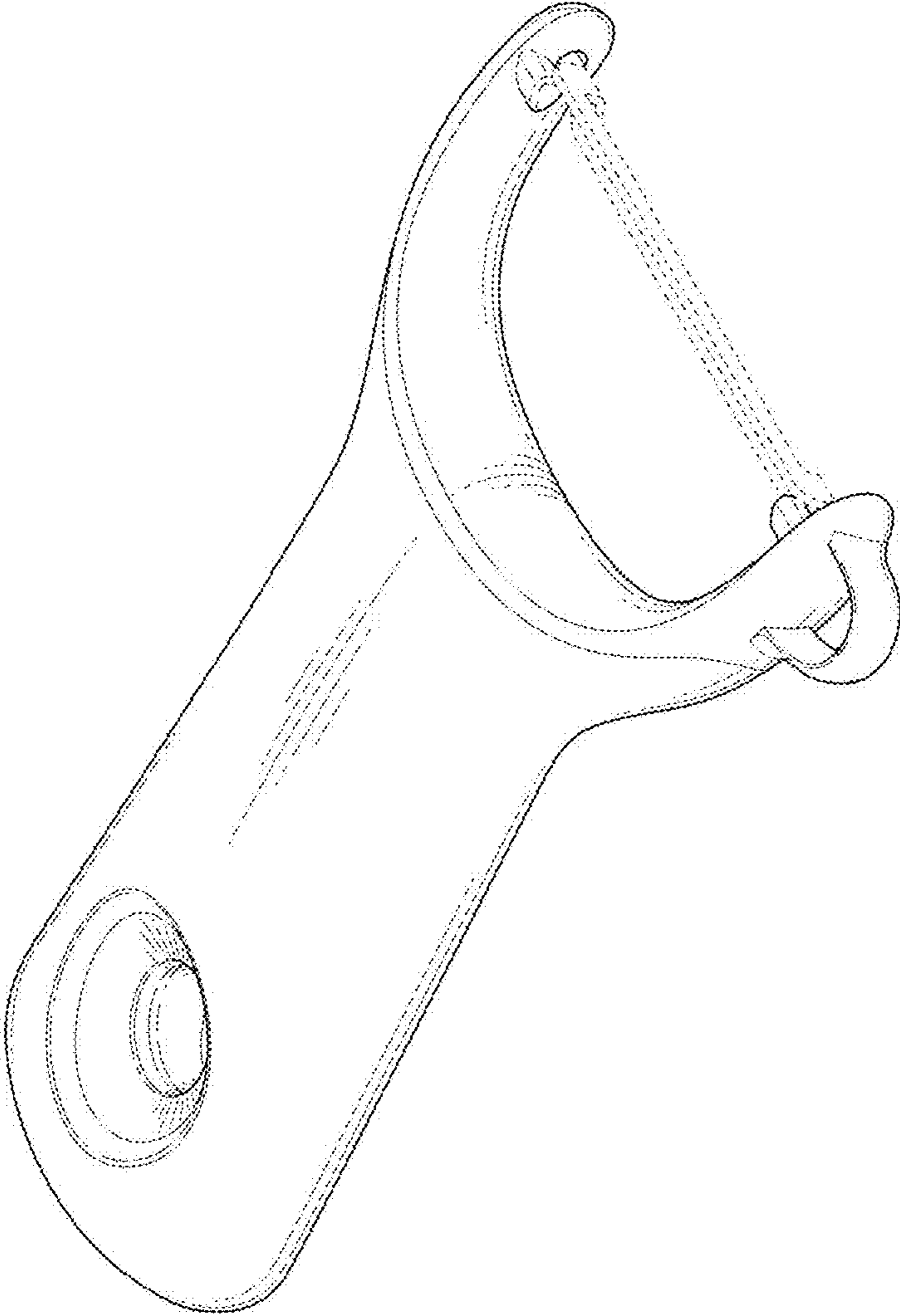

FIG. 1

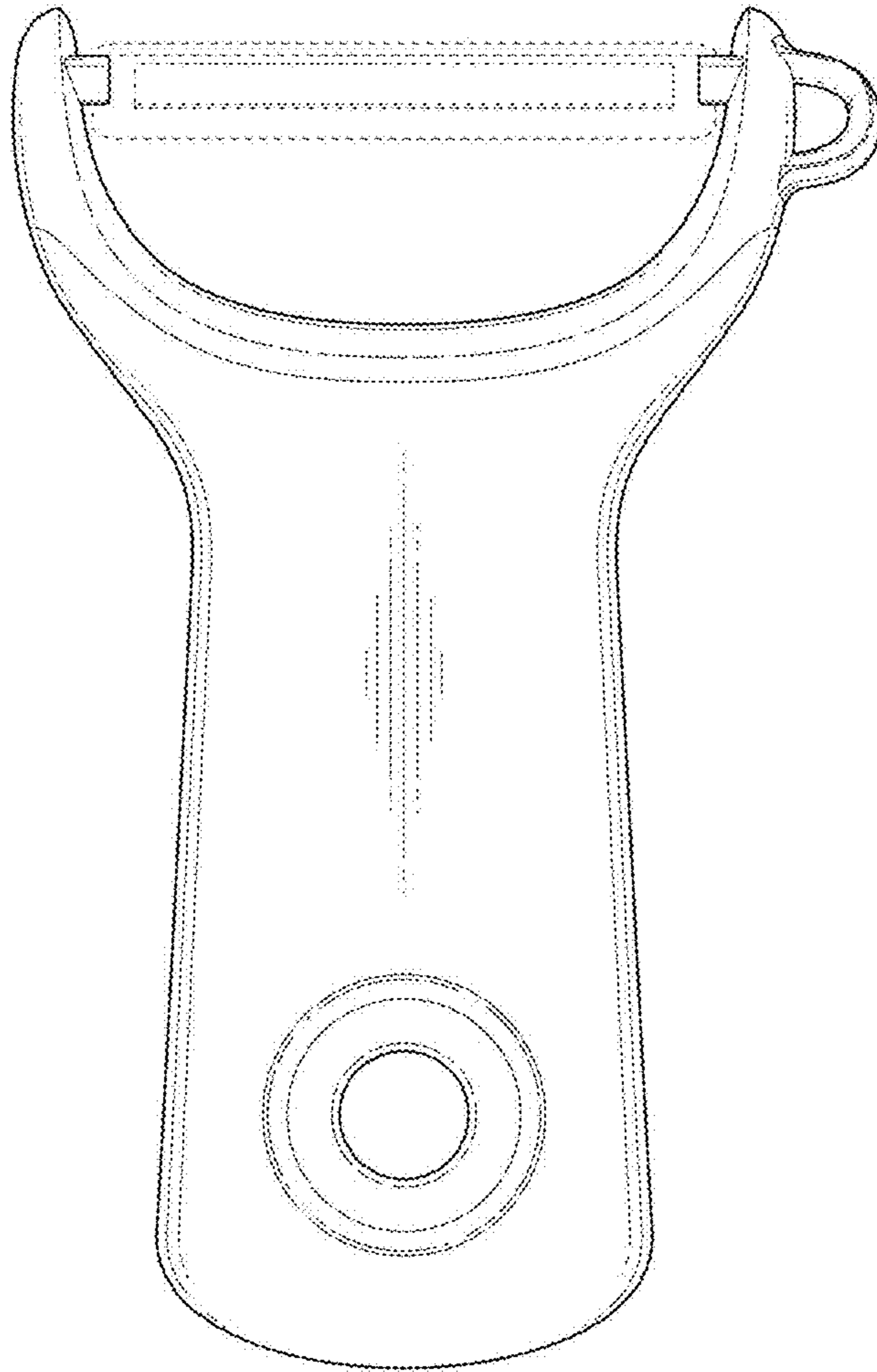

FIG. 2

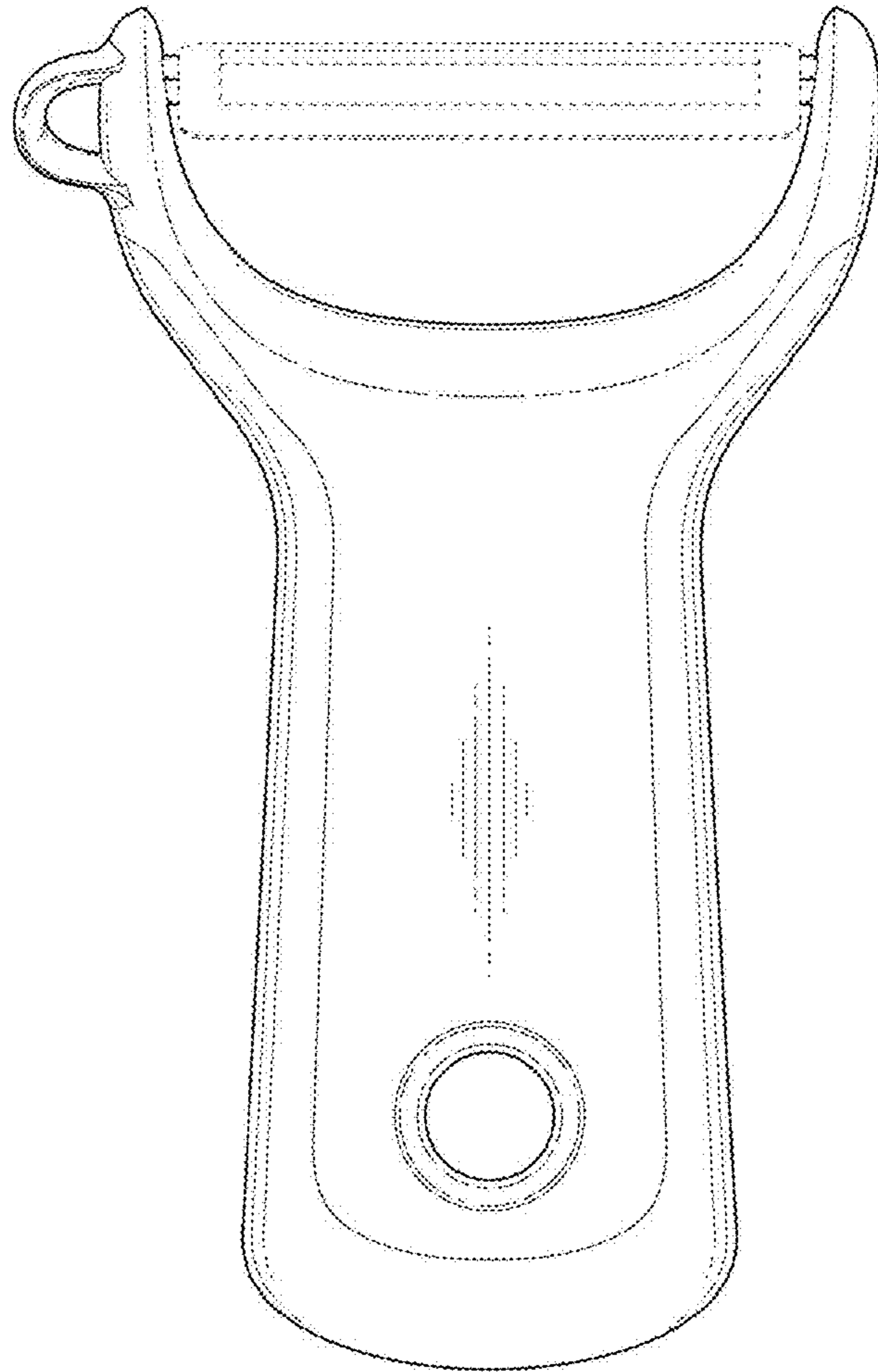

FIG. 3

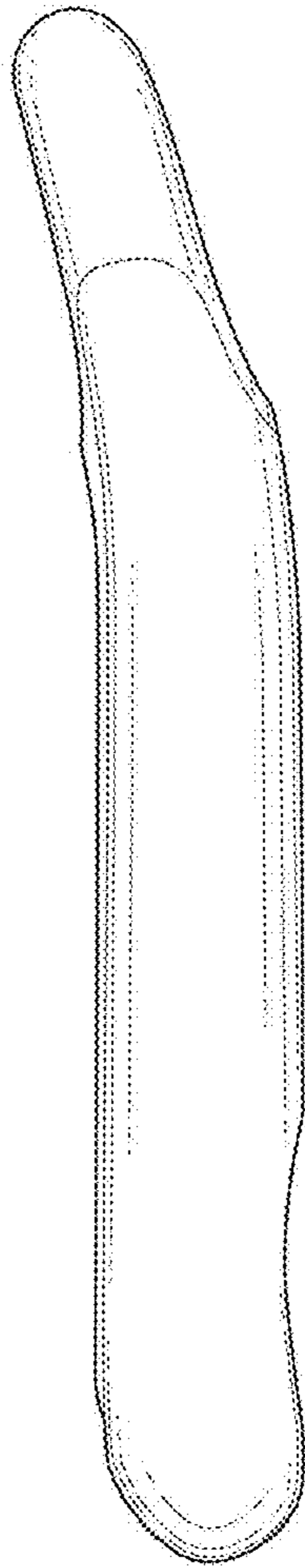

FIG. 4

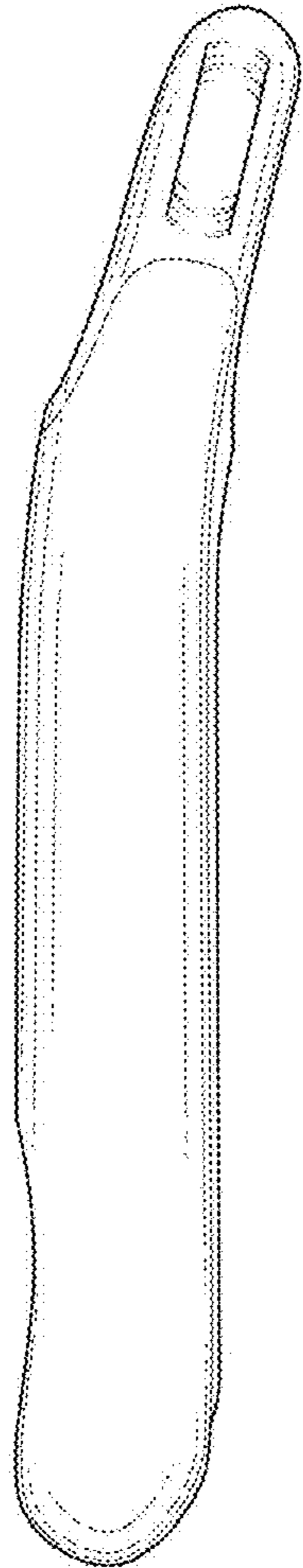

FIG. 5

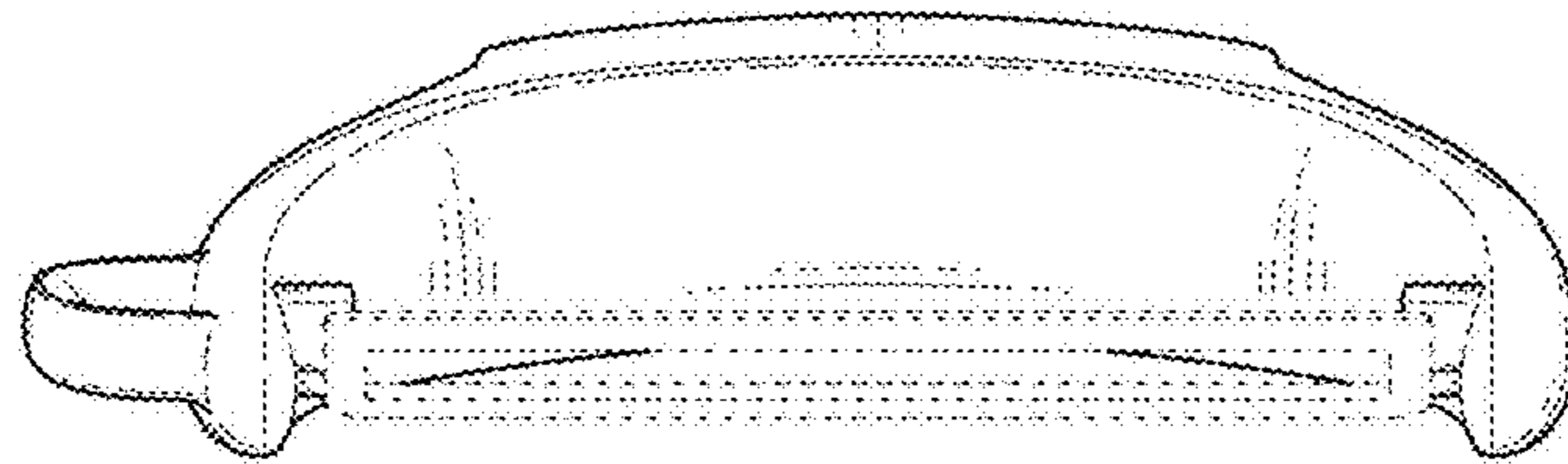

FIG. 6

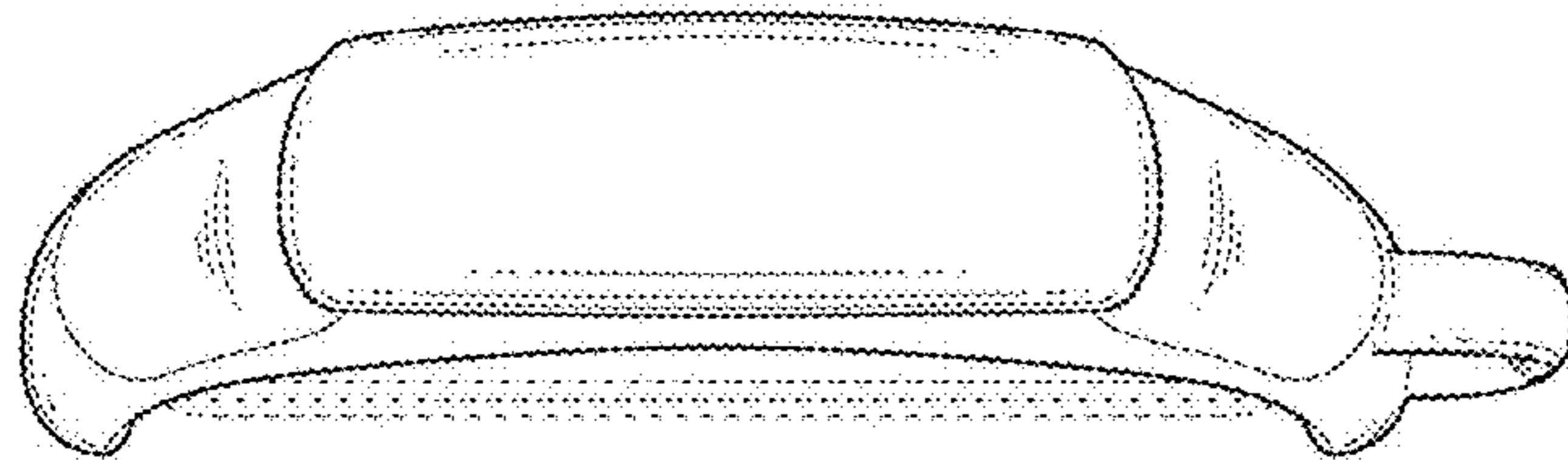

FIG. 7