



US00D859067S

(12) **United States Design Patent** (10) **Patent No.:** **US D859,067 S**  
**Breit et al.** (45) **Date of Patent:** **\*\* Sep. 10, 2019**

(54) **BOTTLE CAP**  
(71) Applicant: **O2COOL, LLC**, Chicago, IL (US)  
(72) Inventors: **Oliver Breit**, Discovery Bay (HK); **Lars Junker**, Kowloon (HK); **Michael Ksiazek**, Burr Ridge, IL (US); **Leonard Scott Huff**, Maryville, TN (US); **Eric F. Junkel**, Mount Prospect, IL (US)  
(73) Assignee: **OZCOOL, LLC**, Chicago, IL (US)  
(\*\*) Term: **15 Years**  
(21) Appl. No.: **29/607,015**  
(22) Filed: **Jun. 9, 2017**  
(51) **LOC (12) Cl.** ..... **07-99**  
(52) **U.S. Cl.**  
USPC ..... **D7/392.1**  
(58) **Field of Classification Search**  
USPC ..... D9/452, 453, 454, 435, 447, 449;  
D7/391, 392, 392.1, 510, 511, 538, 540,  
D7/542, 543, 544, 545, 629  
CPC ... A47G 19/2205; A47G 19/2222; A45F 3/16;  
A45F 3/20; B67D 7/06; B67D 7/0004;  
B65D 25/14; B65D 47/065; B65D  
47/066; B65D 2543/00101; B65D  
2543/00027  
See application file for complete search history.

D718,626 S \* 12/2014 Lane ..... B65D 41/62  
D9/449  
D744,290 S \* 12/2015 Endo ..... D7/608  
D747,918 S \* 1/2016 Herbst ..... D7/392.1  
D763,082 S \* 8/2016 Bos ..... D9/449  
D790,343 S \* 6/2017 Velmer ..... D9/449  
D794,453 S \* 8/2017 Boroski ..... D7/392.1  
D798,715 S \* 10/2017 Sims ..... D9/448  
D821,137 S \* 6/2018 Boroski ..... D7/392.1  
D830,118 S \* 10/2018 Ksiazek ..... D7/392.1  
2011/0284541 A1\* 11/2011 Webster ..... B65D 23/10  
220/288

**FOREIGN PATENT DOCUMENTS**

EM EU0004539518-0001 \* 12/2017  
\* cited by examiner

*Primary Examiner* — Karen S Acker  
*Assistant Examiner* — Steven B Reinholdt, Jr.  
(74) *Attorney, Agent, or Firm* — Thompson Coburn LLP

(57) **CLAIM**

The ornamental design for a bottle cap, as shown and described.

**DESCRIPTION**

FIG. 1 is a perspective view of the bottle cap showing our new design;  
FIG. 2 is a second perspective view thereof;  
FIG. 3 is a left side view thereof;  
FIG. 4 is a right side view thereof;  
FIG. 5 is a front view thereof;  
FIG. 6 is a rear view thereof;  
FIG. 7 is a top view thereof; and,  
FIG. 8 is a bottom view thereof.  
The broken lines and areas adjacent to shaded areas depict portions of the bottle cap that form no part of the claimed design. Other broken lines illustrating a bottle depict environmental subject matter that forms no part of the claimed design.

**1 Claim, 7 Drawing Sheets**

(56) **References Cited**  
U.S. PATENT DOCUMENTS  
D451,023 S \* 11/2001 Kitamura ..... D9/449  
D490,709 S \* 6/2004 Bezek ..... D9/444  
D530,609 S \* 10/2006 Beaver ..... D9/445  
D547,184 S \* 7/2007 Kim ..... D9/447  
D589,743 S \* 4/2009 Pearson ..... D7/392  
7,712,618 B2 \* 5/2010 Barre ..... B65D 47/0871  
215/237  
D629,644 S \* 12/2010 Zhuang ..... D7/392.1  
D655,581 S \* 3/2012 Kotani ..... D7/608

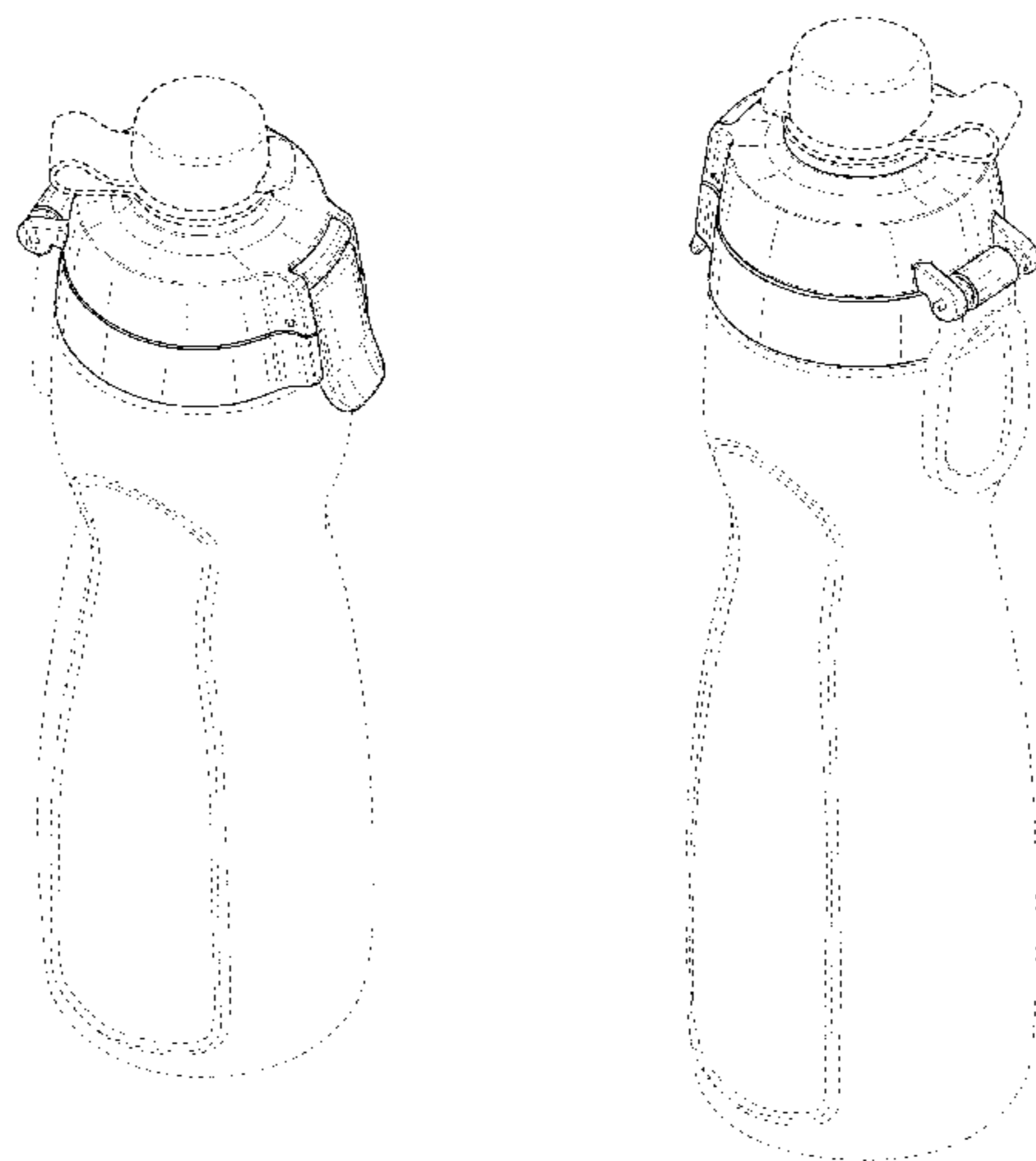

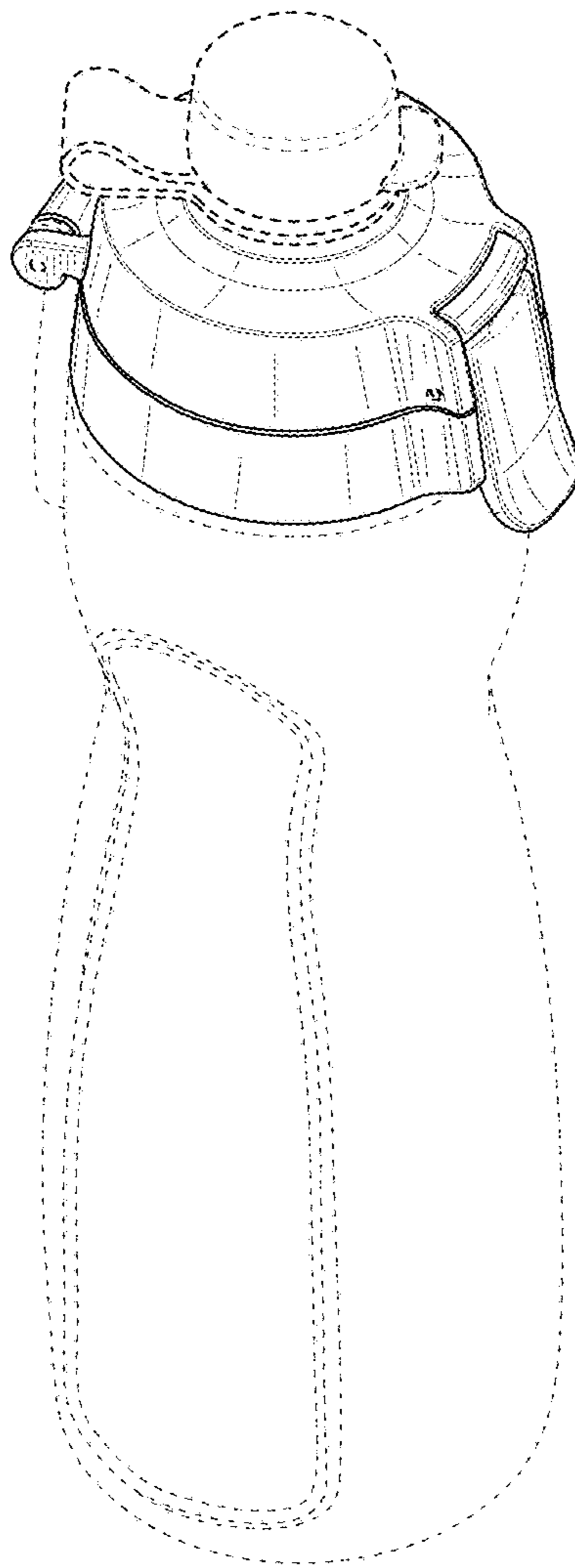

FIG. 1

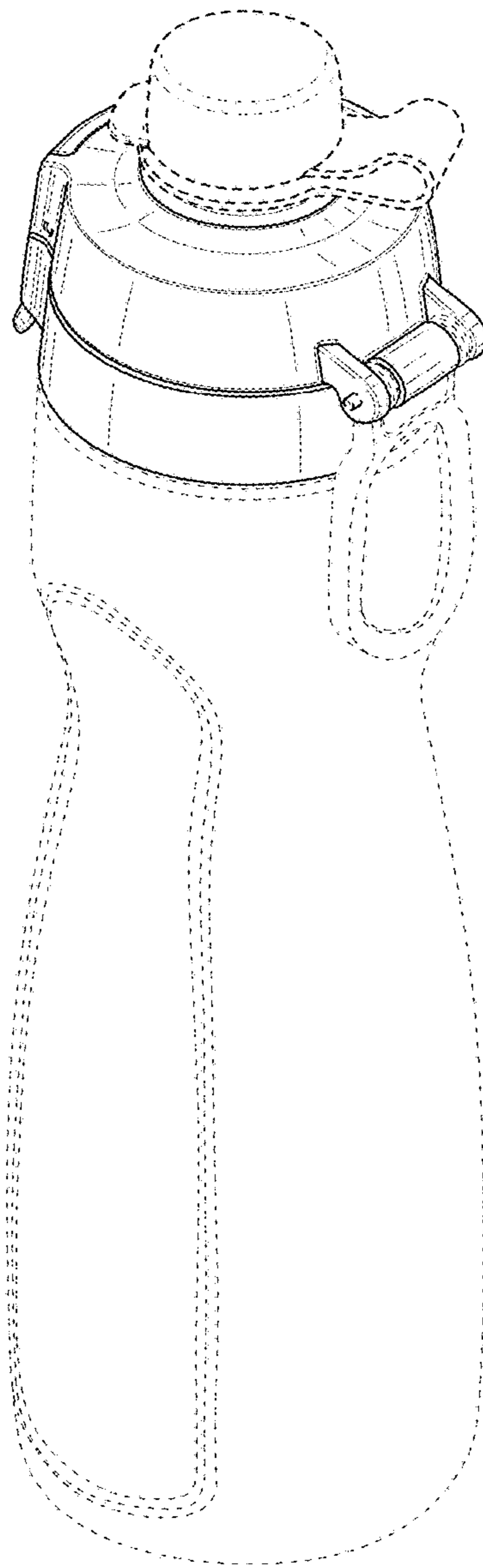

FIG. 2

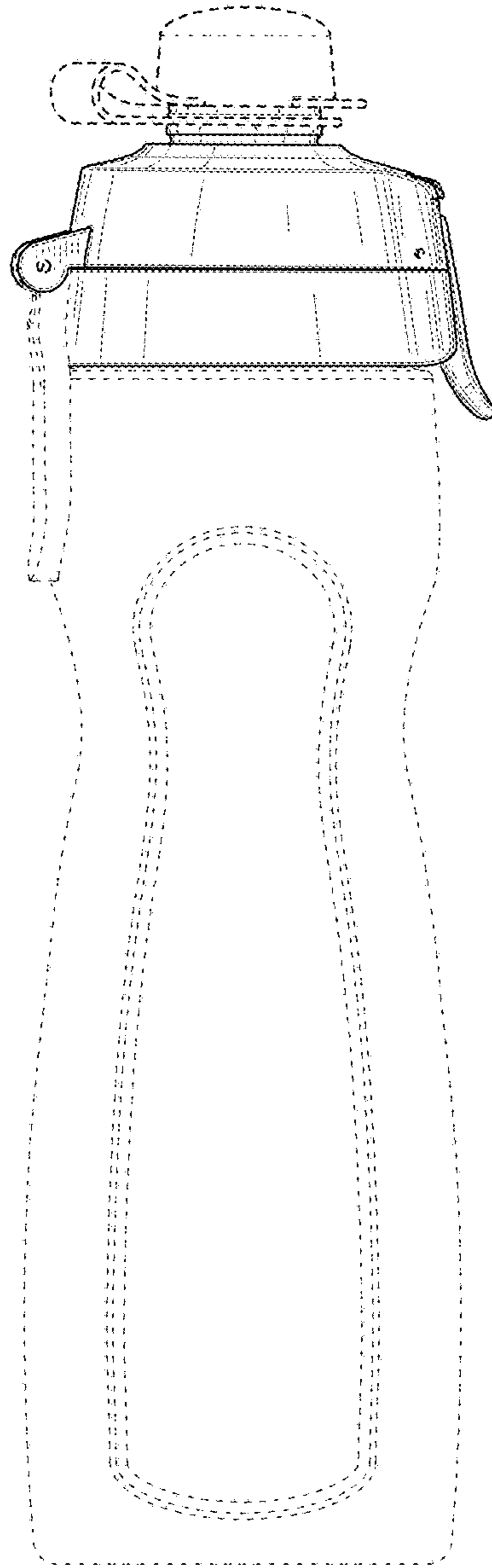

FIG. 3

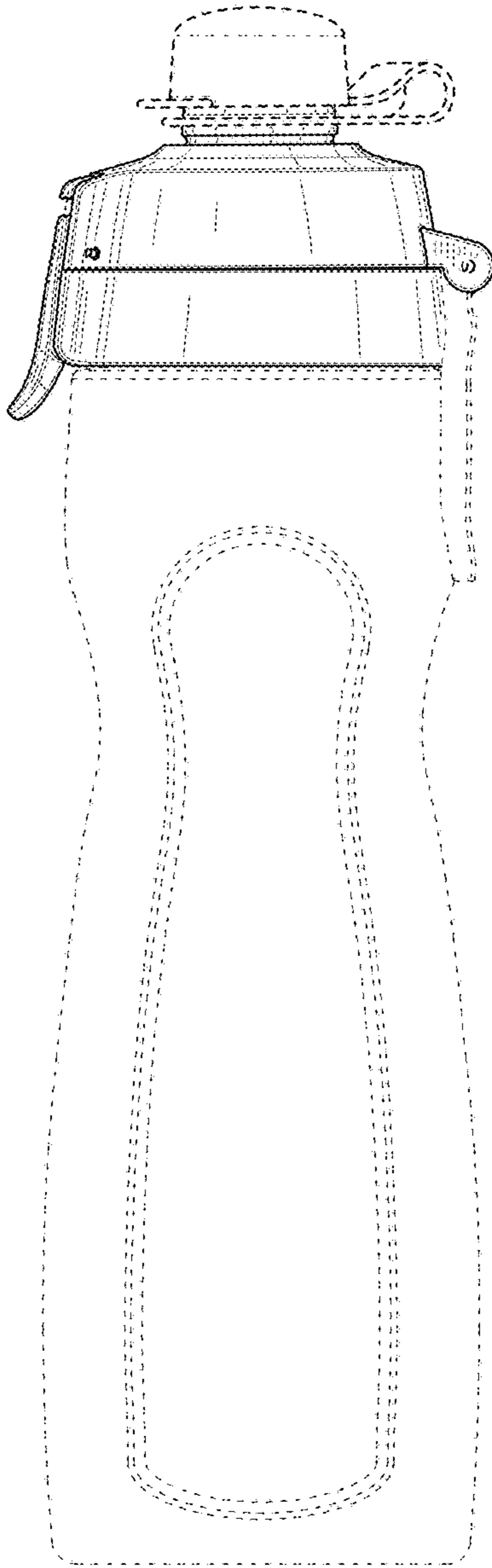

FIG. 4

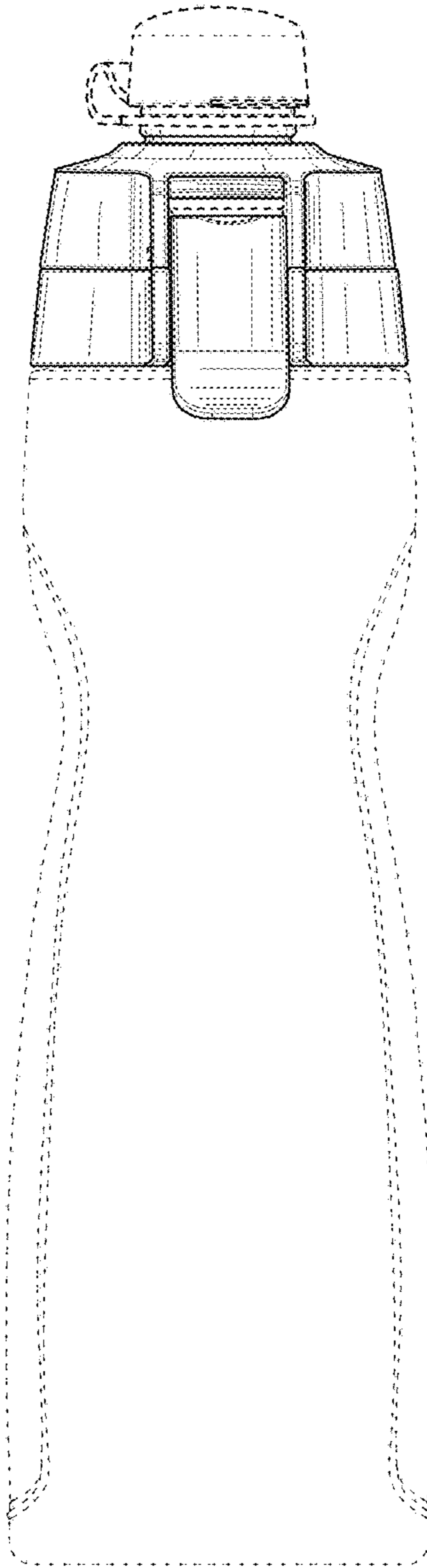

FIG. 5

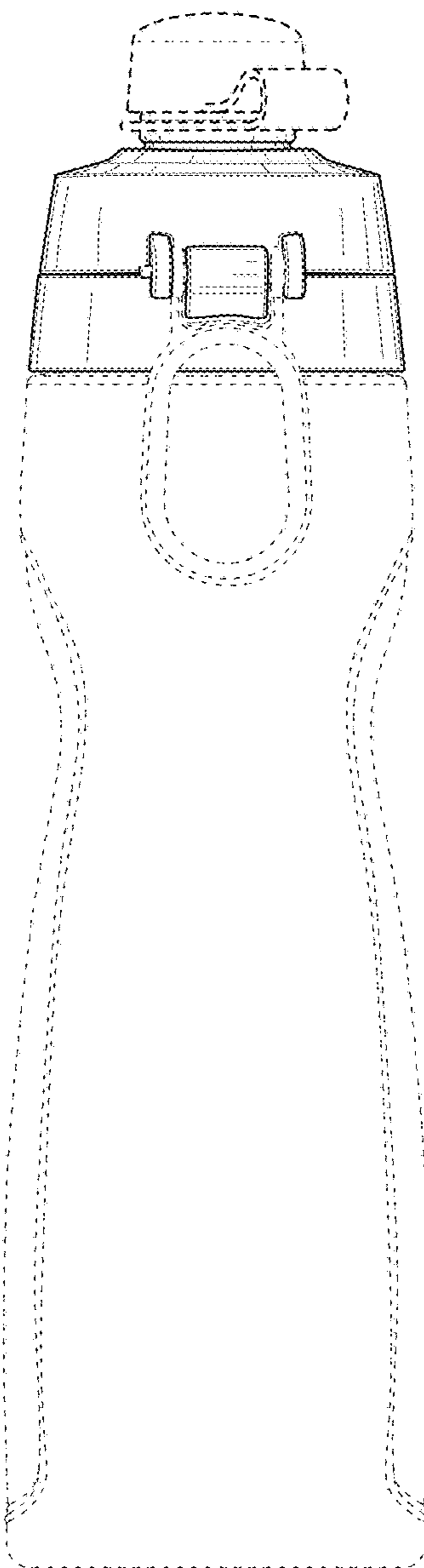

FIG. 6

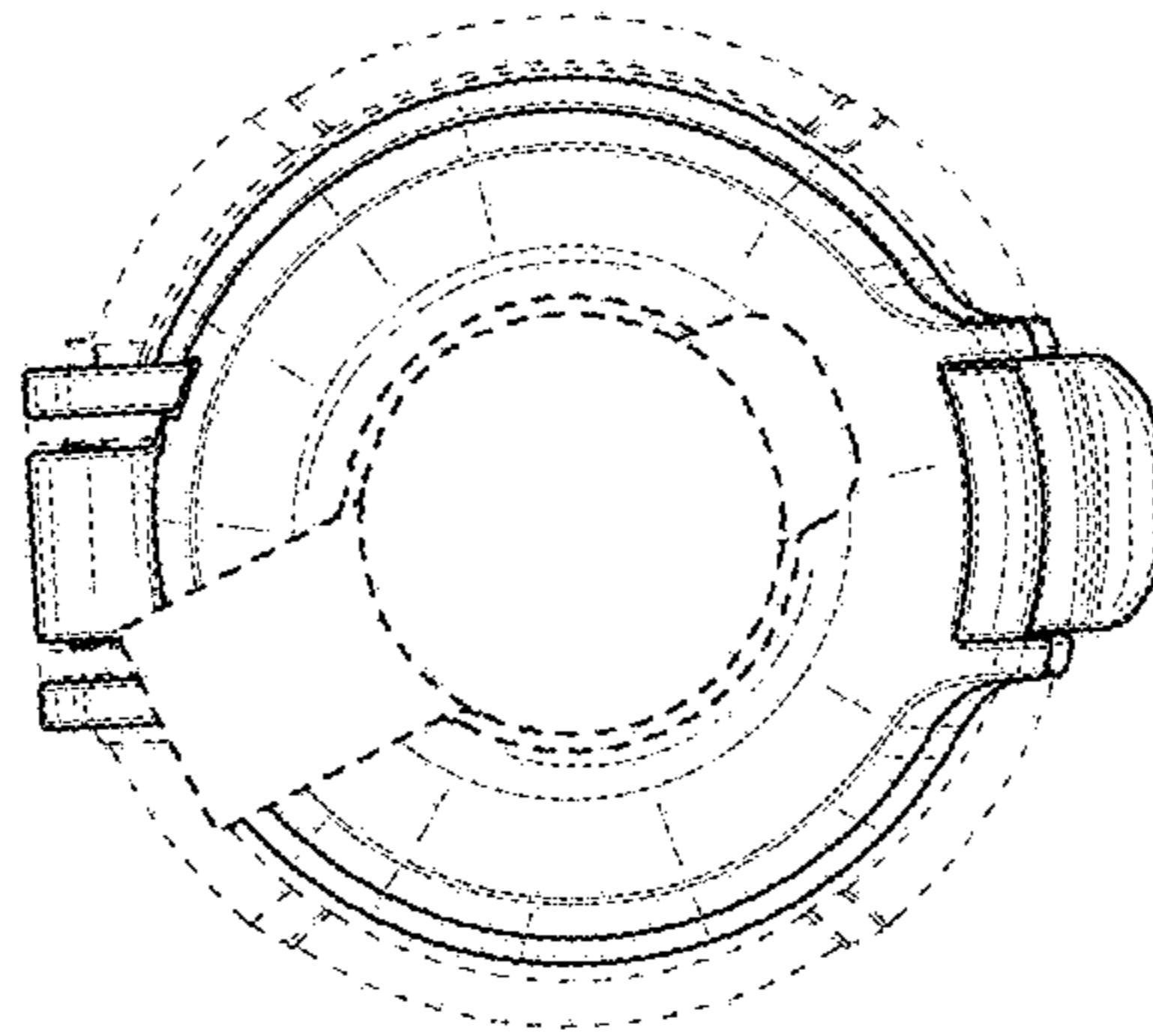

FIG. 7

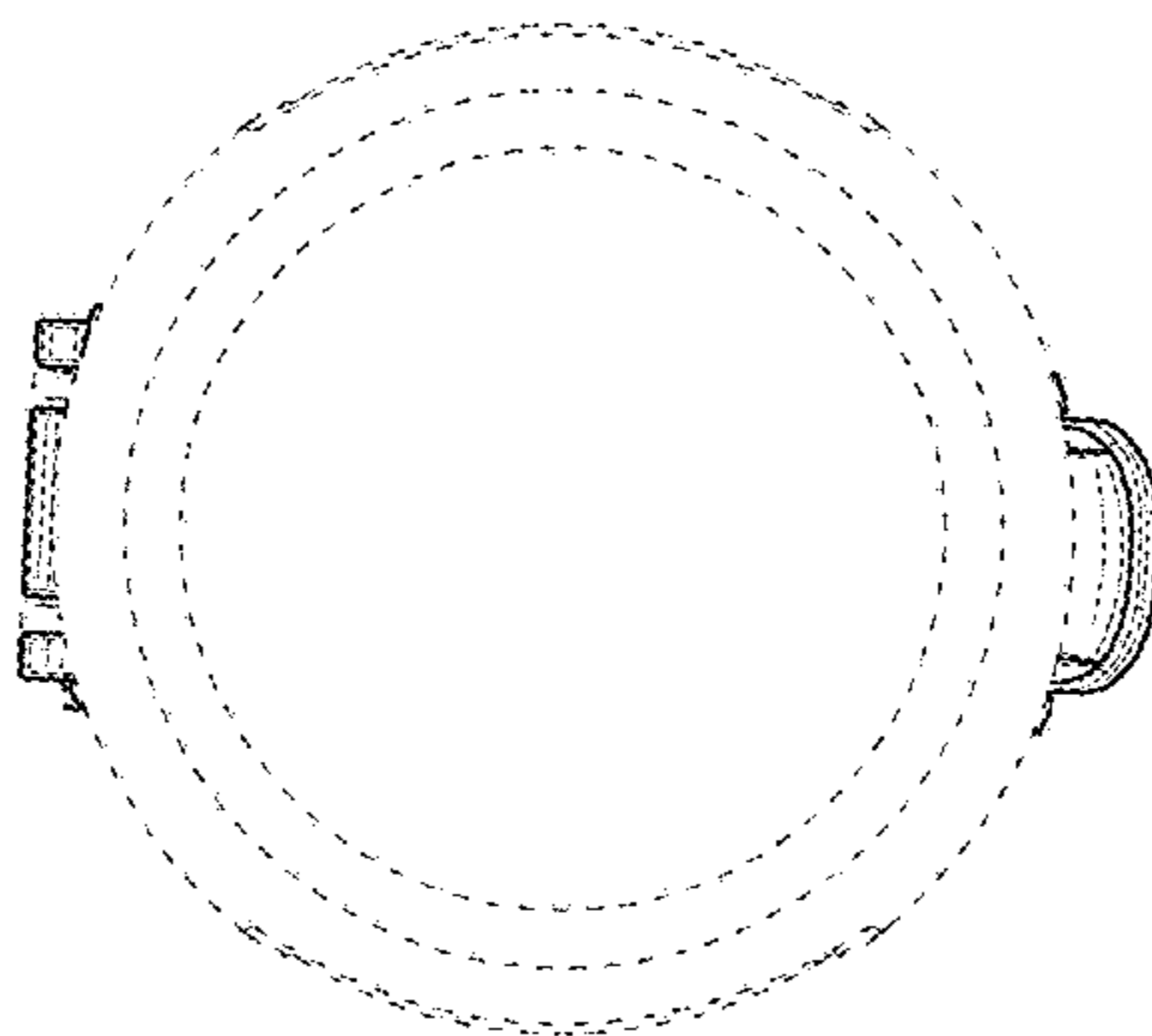

FIG. 8



UNITED STATES PATENT AND TRADEMARK OFFICE  
**CERTIFICATE OF CORRECTION**

PATENT NO. : D859,067 S  
APPLICATION NO. : 29/607015  
DATED : September 10, 2019  
INVENTOR(S) : Breit et al.

Page 1 of 1

It is certified that error appears in the above-identified patent and that said Letters Patent is hereby corrected as shown below:

On the Title Page

(73) Assignee: OZCOOL, LLC should be O2COOL, LLC

Signed and Sealed this  
Twenty-ninth Day of October, 2019

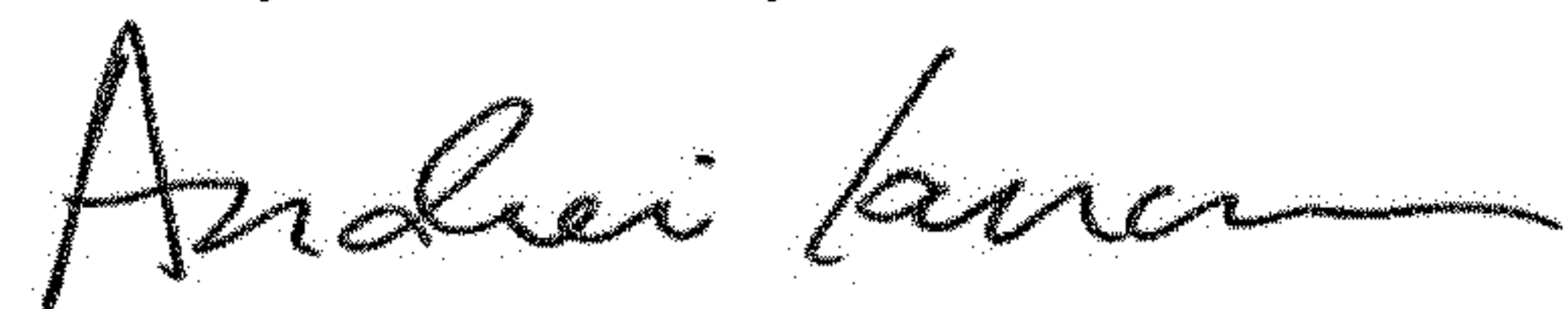

Andrei Iancu  
*Director of the United States Patent and Trademark Office*