



US00D858917S

(12) **United States Design Patent**
Hui

(10) **Patent No.:** **US D858,917 S**

(45) **Date of Patent:** **** Sep. 3, 2019**

(54) **POOL CLEANER**

(71) Applicant: **COMPUROBOT TECHNOLOGY COMPANY, Dongguan (CN)**

(72) Inventor: **Wing-Tak Hui, Hong Kong (CN)**

(73) Assignee: **COMPUROBOT TECHNOLOGY COMPANY, Dongguan (CN)**

(**) Term: **15 Years**

(21) Appl. No.: **29/641,760**

(22) Filed: **Mar. 23, 2018**

(51) **LOC (12) Cl.** **15-05**

(52) **U.S. Cl.**
USPC **D32/21**

(58) **Field of Classification Search**
USPC 15/1.7; 210/416.2, 167.16, 167.15;
D32/18, 21, 32-33
CPC ... E04H 4/1609; E04H 4/1654; E04H 4/1663;
E04H 4/1672; E04H 4/169; E04H 4/1636
See application file for complete search history.

(56) **References Cited**

U.S. PATENT DOCUMENTS

D408,104 S *	4/1999	Adam	D32/21
D445,225 S *	7/2001	Schaub	D32/21
D526,101 S *	8/2006	Blanc-Tailleur	D32/16
D529,669 S *	10/2006	Blanc-Tailleur	D32/21
D575,915 S *	8/2008	Dreyer	D32/21
D598,168 S *	8/2009	Sumonthee	D32/21
D599,967 S *	9/2009	Blanc-Tailleur	D32/21
8,341,789 B2 *	1/2013	Garti	E04H 4/1654 15/1.7
8,510,889 B2 *	8/2013	Hui	E04H 4/1654 15/1.7

8,771,504 B2 *	7/2014	Mastio	E04H 4/1654 15/1.7
D721,460 S *	1/2015	Hanan	D32/21
9,222,275 B2 *	12/2015	Ben Dov	E04H 4/1654
9,359,782 B2 *	6/2016	Hui	E04H 4/1654
9,506,262 B2 *	11/2016	Tavor	E04H 4/1654
9,527,537 B2 *	12/2016	Bernini	E04H 4/1654
9,790,700 B2 *	10/2017	Tamar	H02K 7/1823
9,809,989 B2 *	11/2017	Blanc Tailleur	E04H 4/1654
9,809,990 B1 *	11/2017	Hui	E04H 4/1654
9,902,477 B1 *	2/2018	Durvasula	B63C 11/42
9,995,050 B2 *	6/2018	Durvasula	E04H 4/1654
10,053,883 B2 *	8/2018	Hui	E04H 4/1654
10,167,650 B2 *	1/2019	Torem	E04H 4/1654

* cited by examiner

Primary Examiner — Ruth McInroy

(74) *Attorney, Agent, or Firm* — Weiss & Moy, P.C.;
Jeffrey D. Moy

(57) **CLAIM**

The ornamental design for a pool cleaner, as shown and described.

DESCRIPTION

FIG. 1 is a perspective view of a pool cleaner showing my new design;

FIG. 2 is a front view thereof;

FIG. 3 is a rear view thereof;

FIG. 4 is a left-side view thereof;

FIG. 5 is a right-side view thereof;

FIG. 6 is a top view thereof; and,

FIG. 7 is a bottom view thereof.

The broken lines in the drawings depict portions of the pool cleaner that form no part of the claimed design.

1 Claim, 7 Drawing Sheets

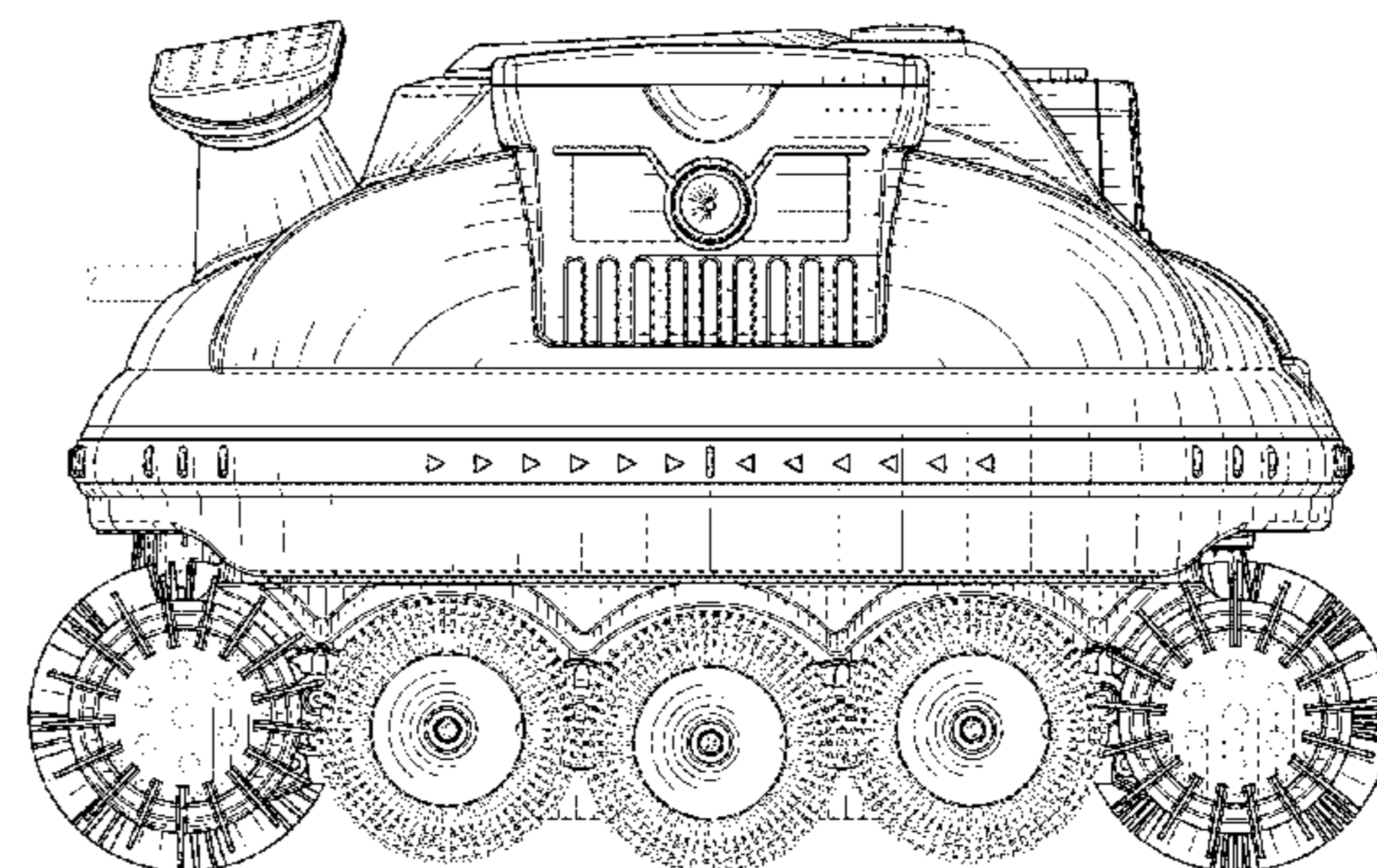
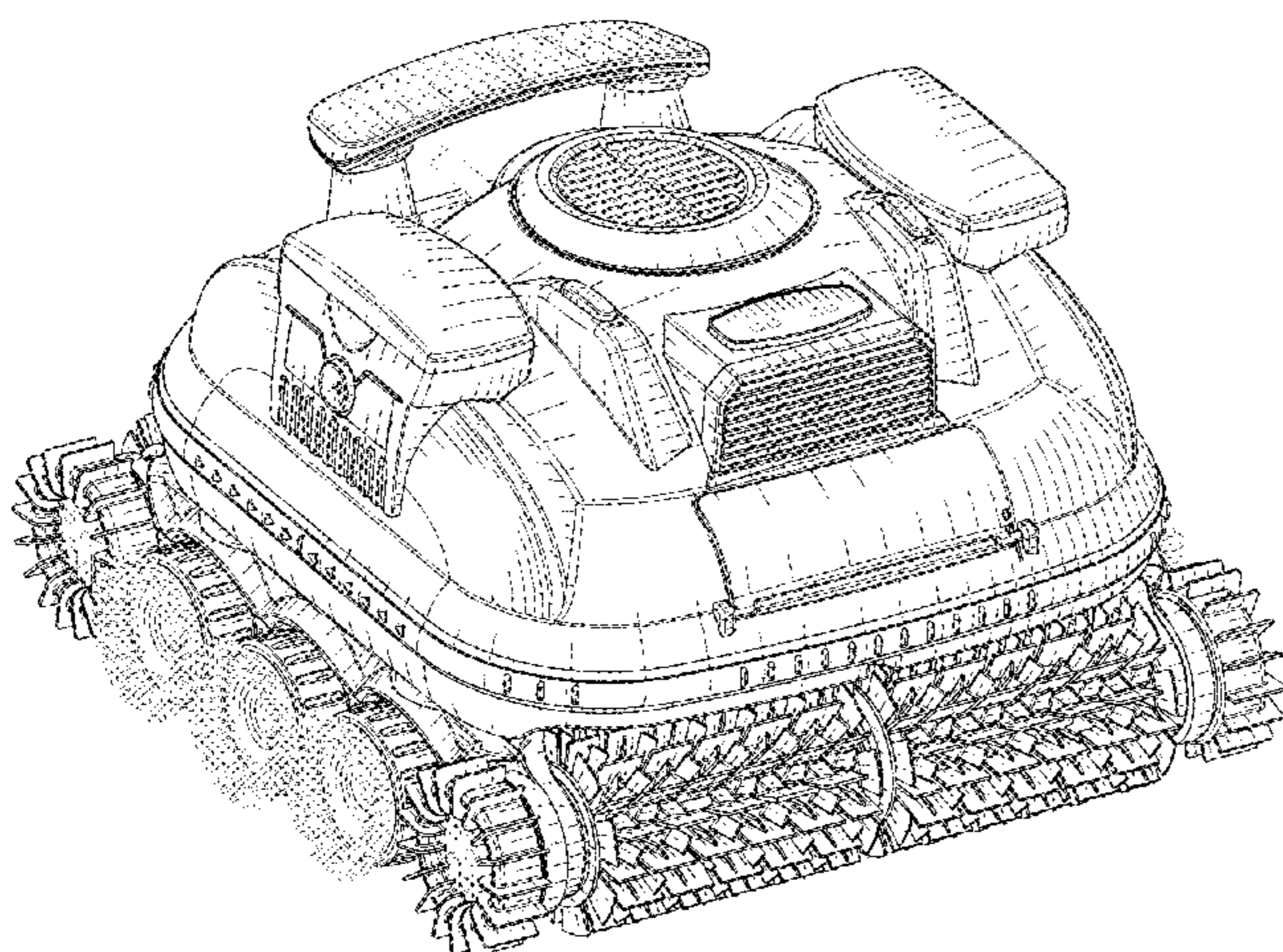

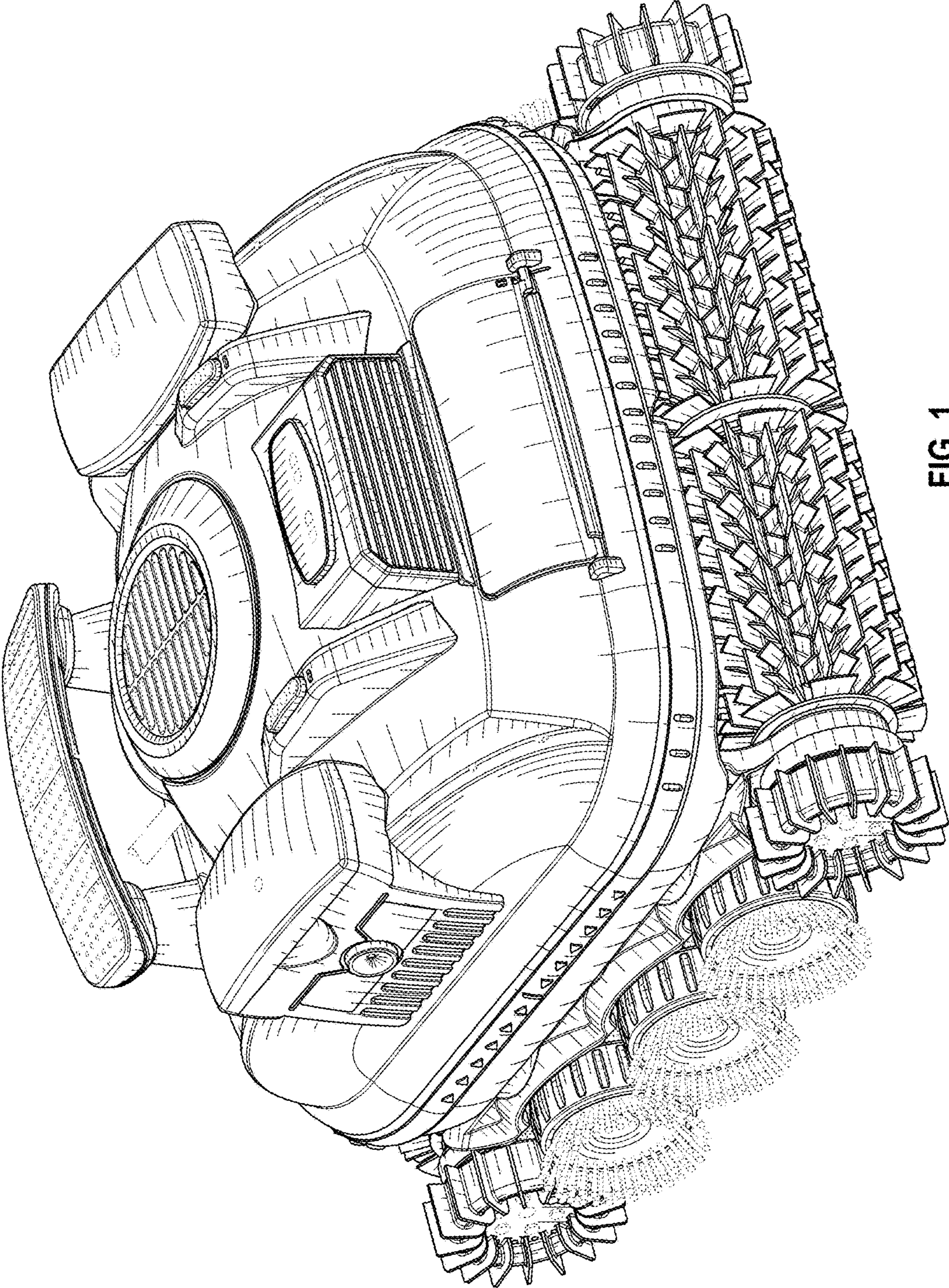

FIG. 1

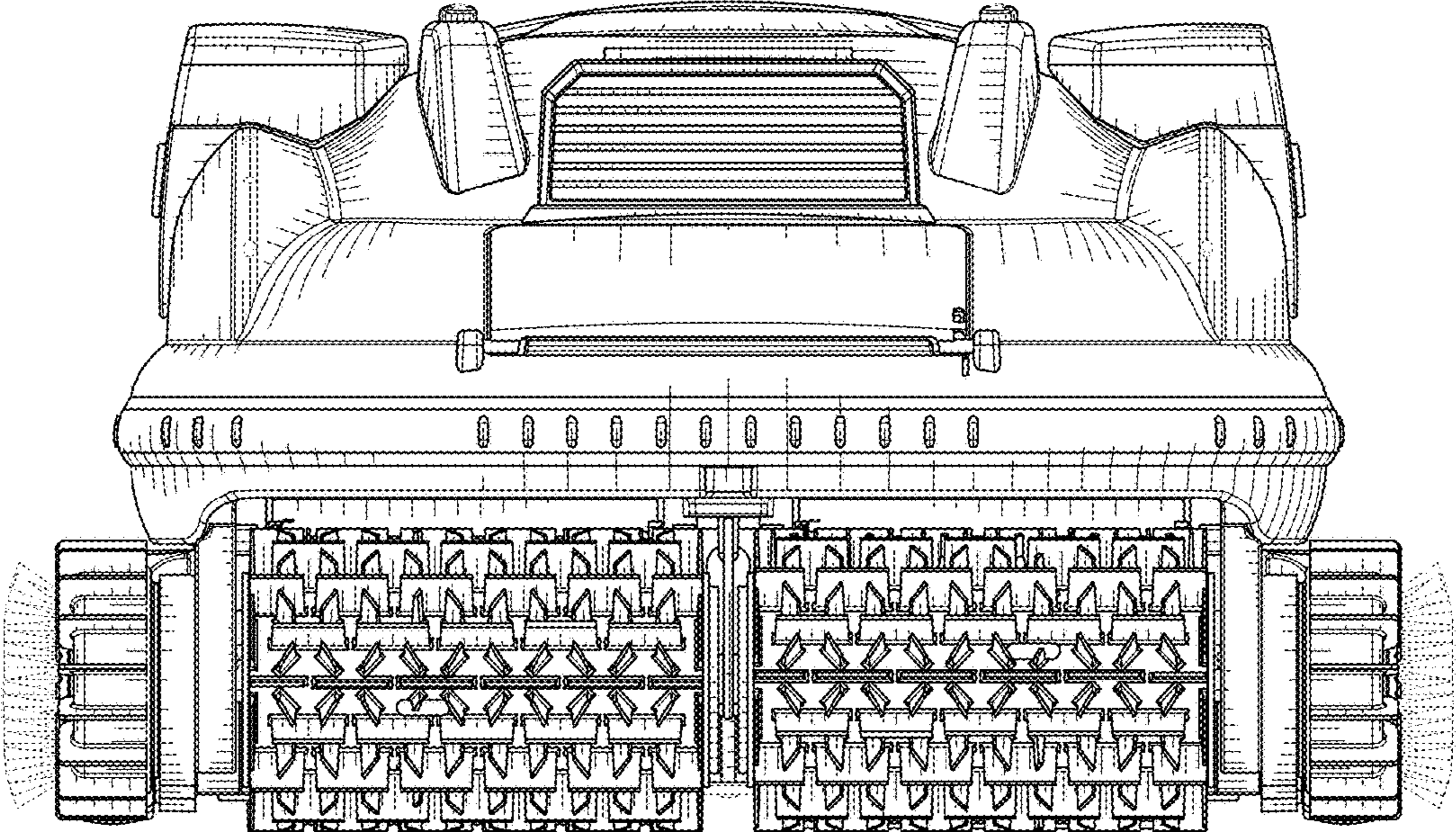

FIG. 2

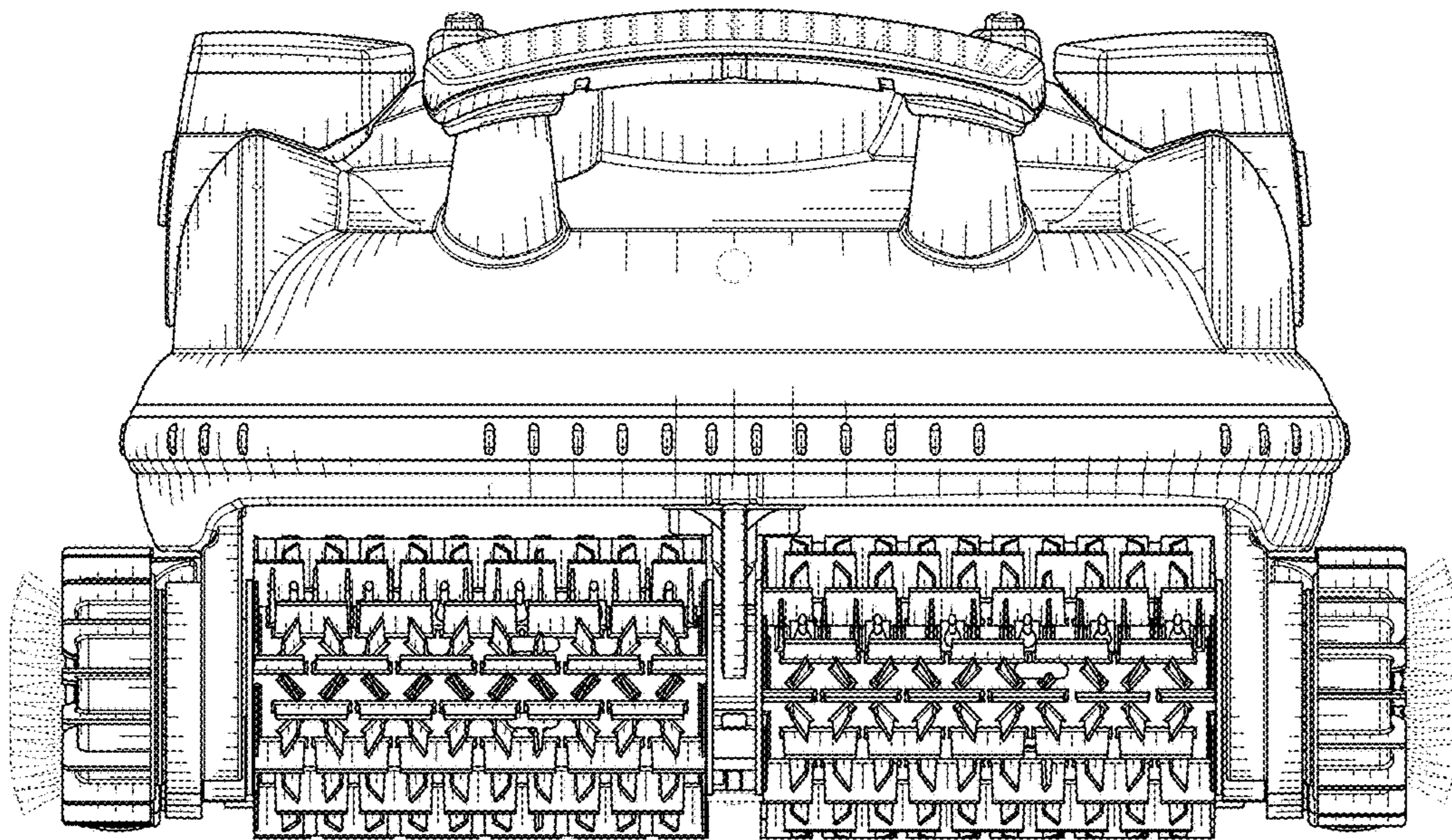

FIG. 3

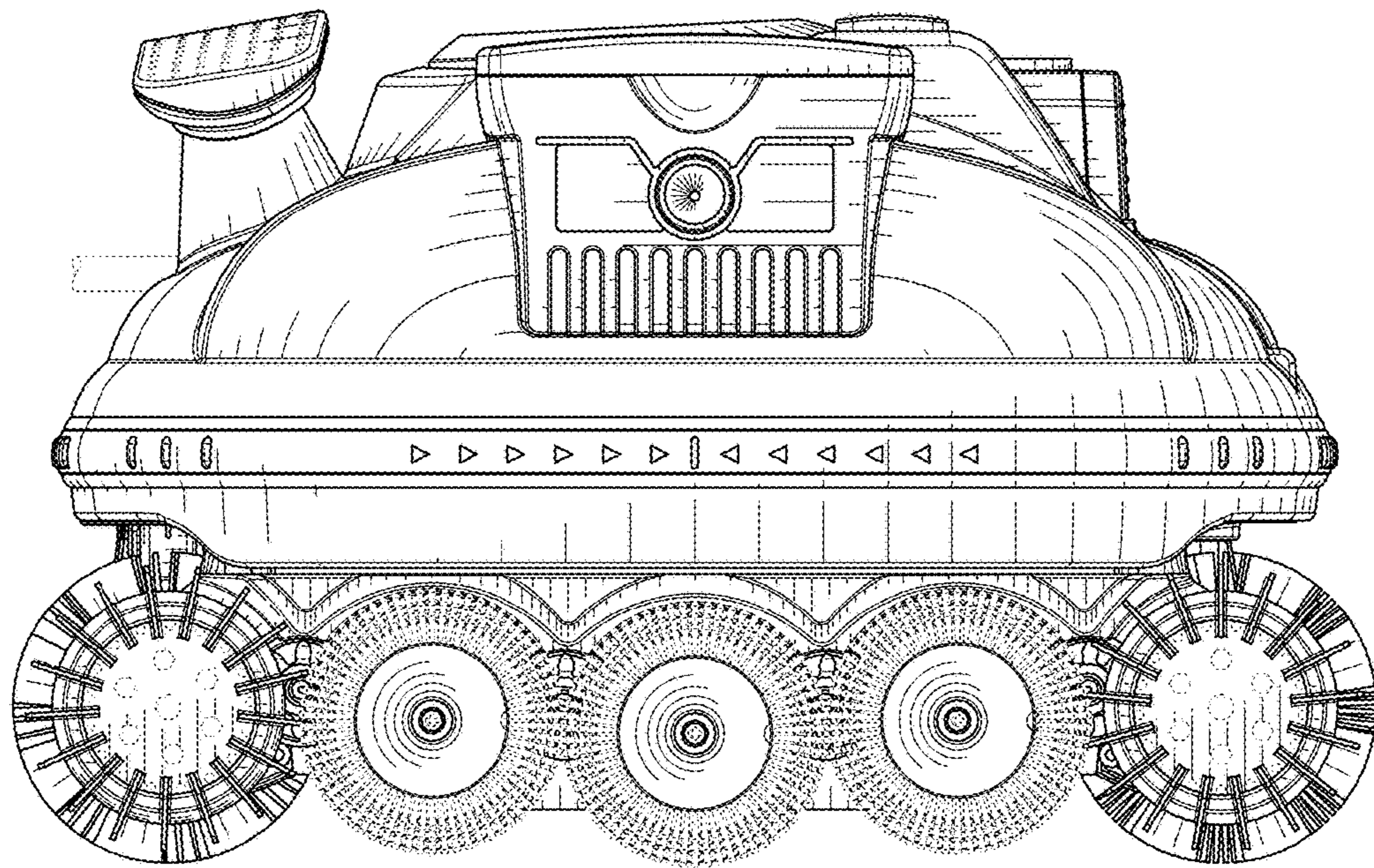

FIG. 4

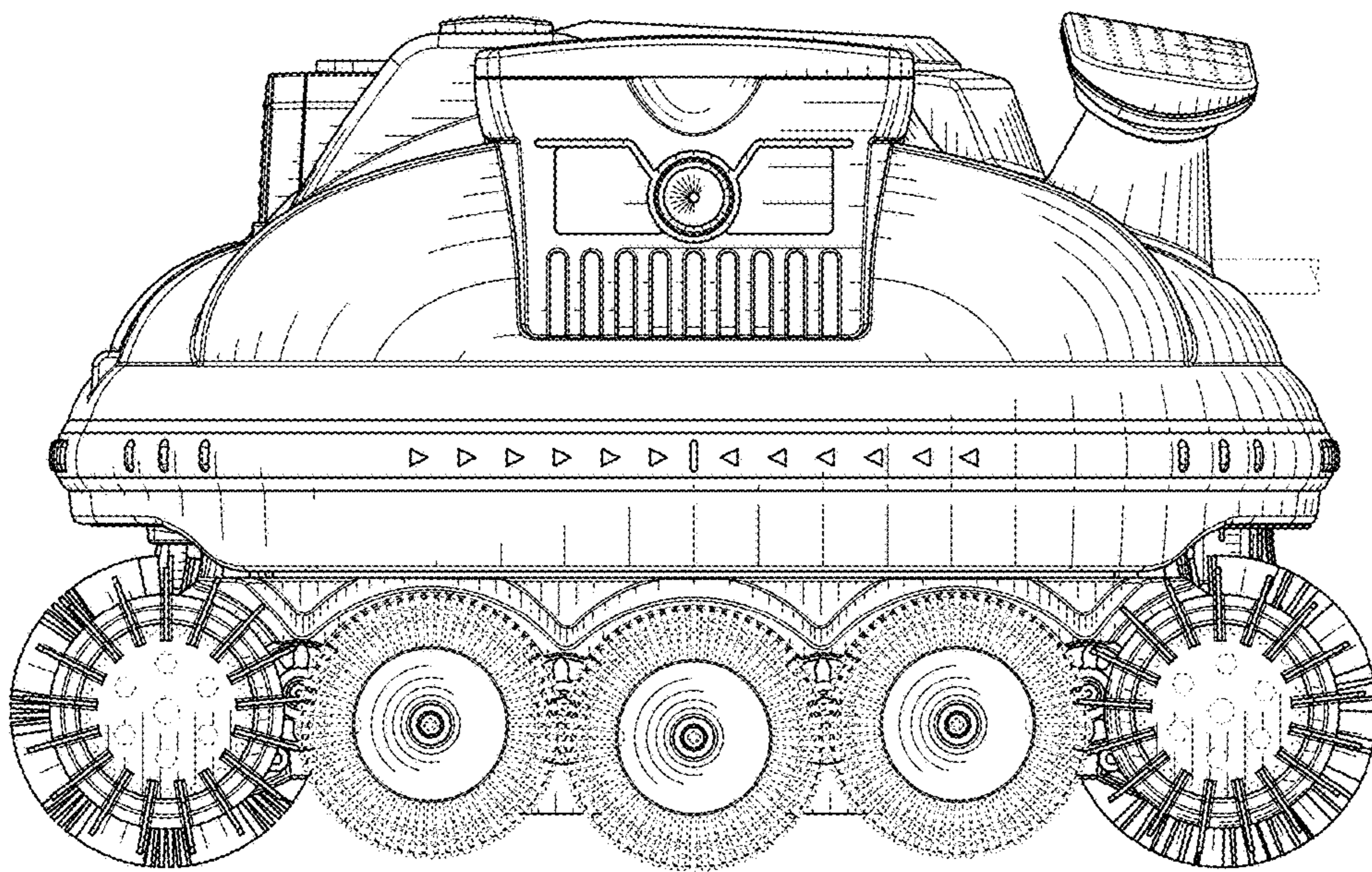

FIG. 5

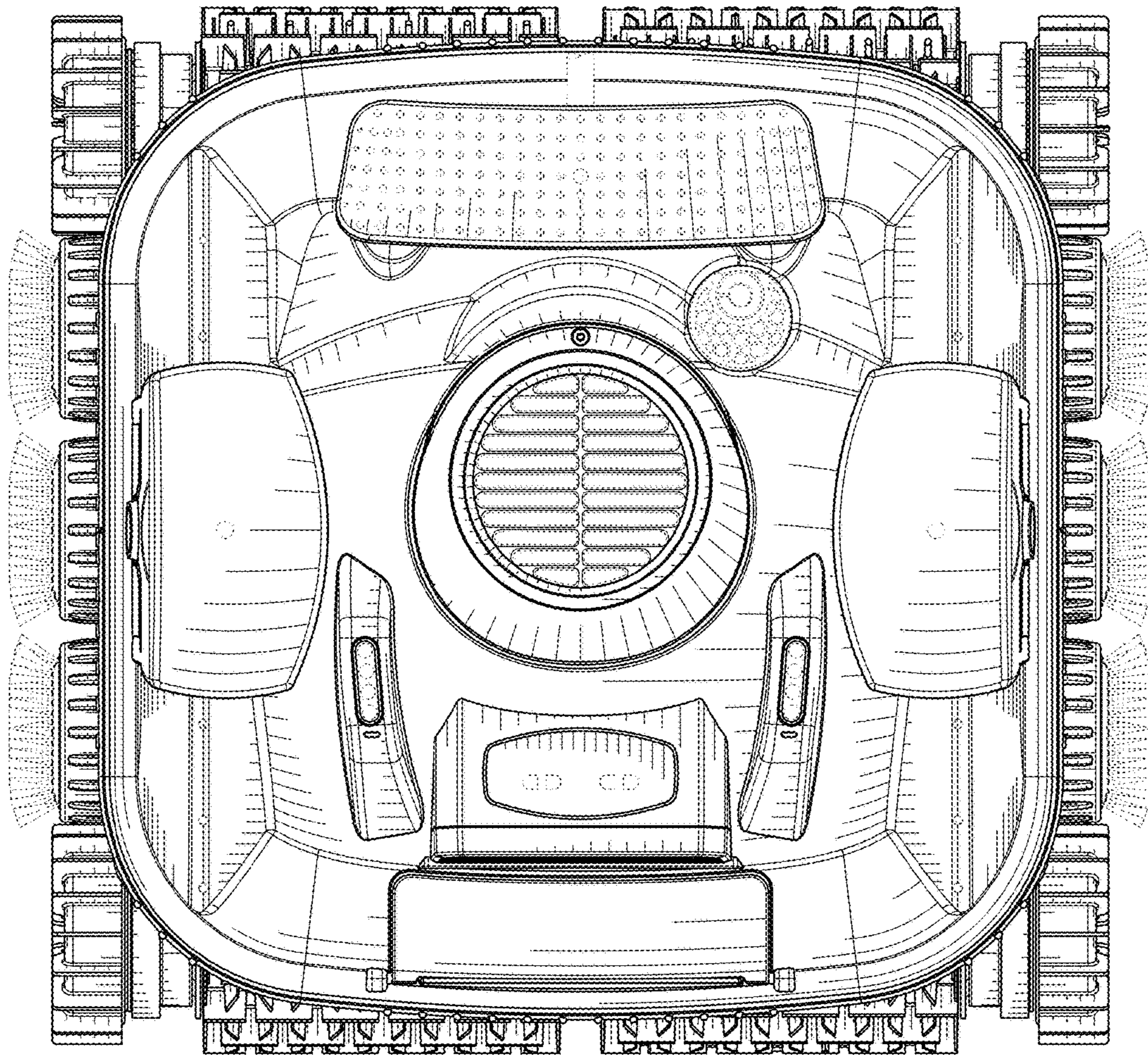

FIG. 6

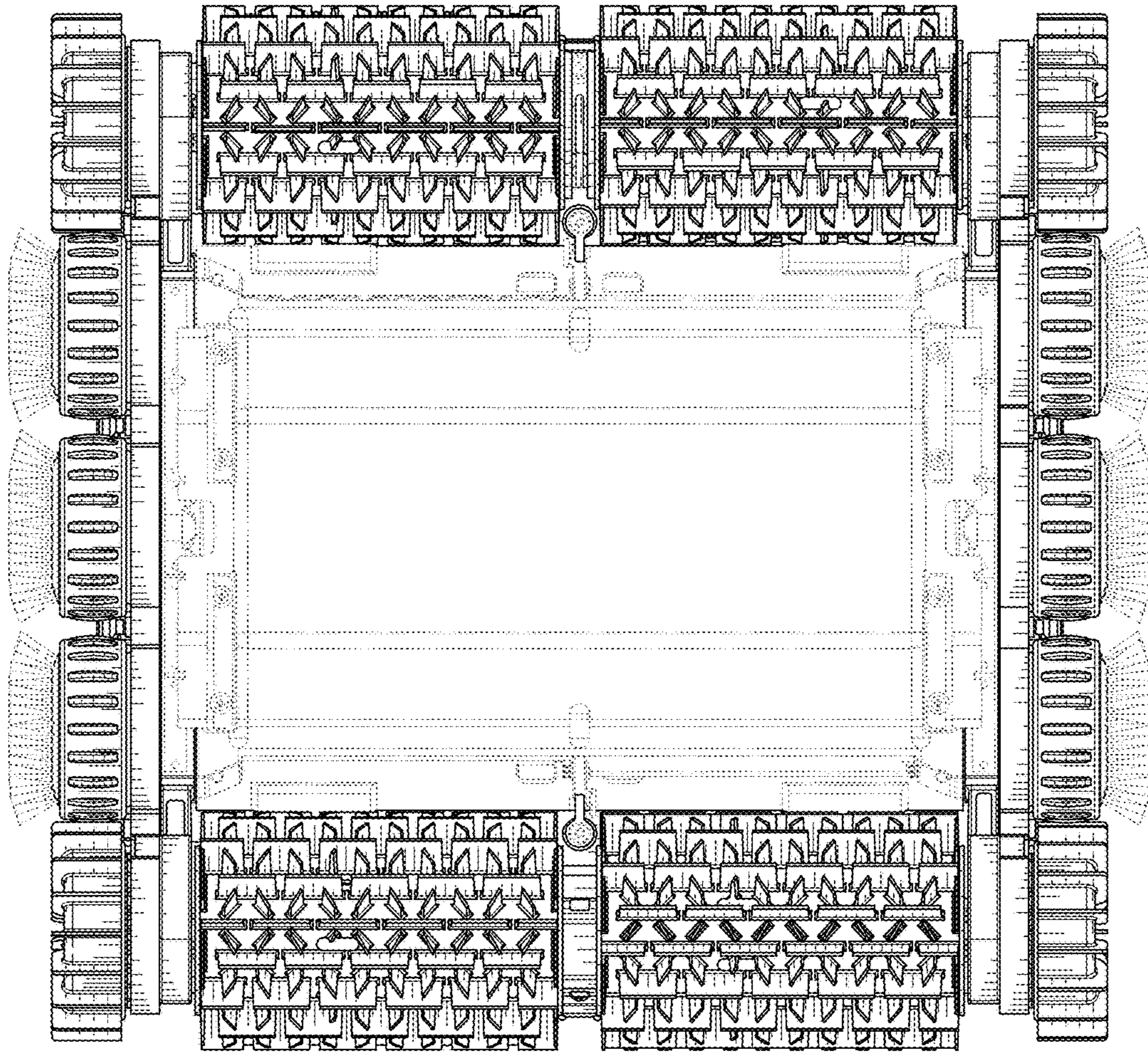

FIG. 7