



US00D858815S

(12) **United States Design Patent**  
**Huang**

(10) **Patent No.:** **US D858,815 S**

(45) **Date of Patent:** **\*\* Sep. 3, 2019**

(54) **VEHICLE LAMP**

(71) Applicant: **SIRIUS LIGHT TECHNOLOGY CO., LTD.**, Tainan (TW)

(72) Inventor: **Ricky Huang**, Tainan (TW)

(73) Assignee: **SIRIUS LIGHT TECHNOLOGY CO., LTD.**, Tainan (TW)

(\*\*) Term: **15 Years**

(21) Appl. No.: **29/642,170**

(22) Filed: **Mar. 28, 2018**

(30) **Foreign Application Priority Data**

Jan. 30, 2018 (TW) ..... 107300585

(51) **LOC (12) Cl.** ..... **26-06**

(52) **U.S. Cl.**  
USPC ..... **D26/28**

(58) **Field of Classification Search**

USPC ..... D26/28-36

CPC ..... F21S 48/00; F21S 48/10; F21S 48/115;  
F21S 48/225; F21S 48/1233; F21S  
48/1266; F21S 48/1388; F21S 48/2268;  
F21V 13/00; F21V 21/04; F21V 29/004

See application file for complete search history.

(56) **References Cited**

**U.S. PATENT DOCUMENTS**

D707,865 S \* 6/2014 Yoshida ..... D26/28  
D728,133 S \* 4/2015 Bieling ..... D26/28

D744,129 S \* 11/2015 Futschik ..... D26/28  
D745,726 S \* 12/2015 McMahan ..... D26/28  
D747,515 S \* 1/2016 McMahan ..... D26/28  
D752,254 S \* 3/2016 Futschik ..... D26/28  
D752,255 S \* 3/2016 Futschik ..... D26/28

\* cited by examiner

*Primary Examiner* — Marcus A Jackson

(74) *Attorney, Agent, or Firm* — LeClairRyan

(57) **CLAIM**

The ornamental design for a vehicle lamp, as shown and described.

**DESCRIPTION**

FIG. 1 is a perspective view of a vehicle lamp showing our new design;

FIG. 2 is a front elevational view thereof;

FIG. 3 is a rear elevational view thereof;

FIG. 4 is a left side elevational view thereof;

FIG. 5 is a right side elevational view thereof;

FIG. 6 is a top plan view thereof; and,

FIG. 7 is a bottom plan view thereof.

The broken lines depict portions of a vehicle lamp in which the design is embodied that form no part of the claimed design.

**1 Claim, 6 Drawing Sheets**

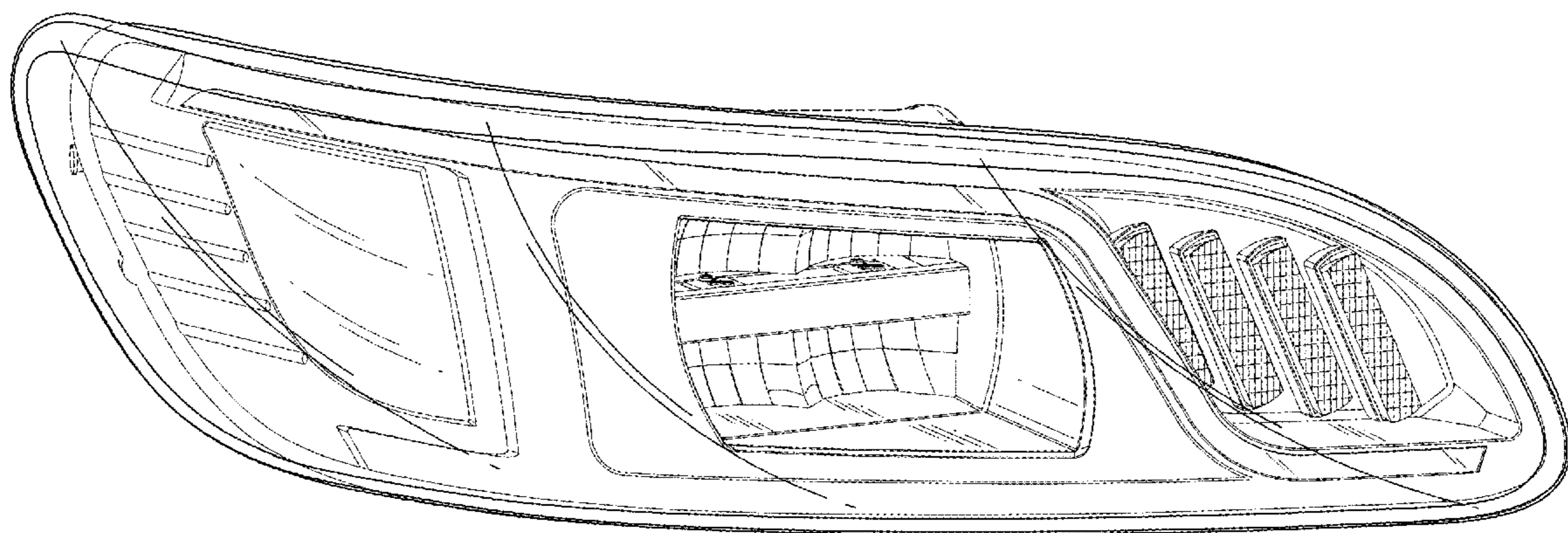

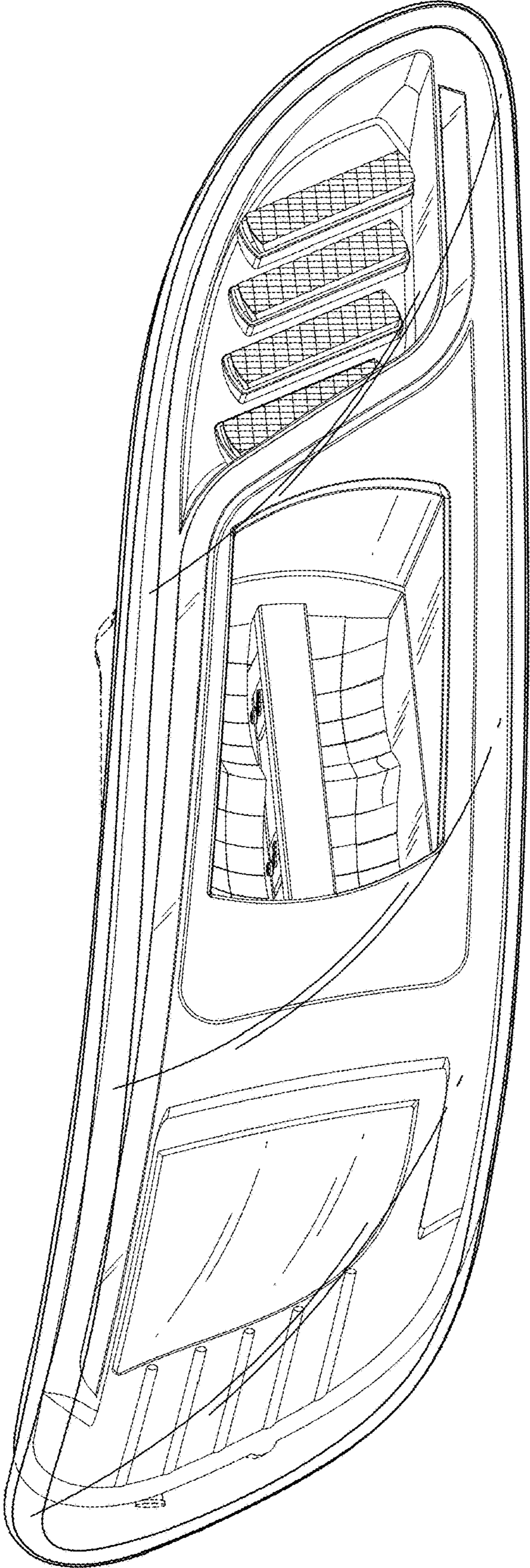

FIG.1

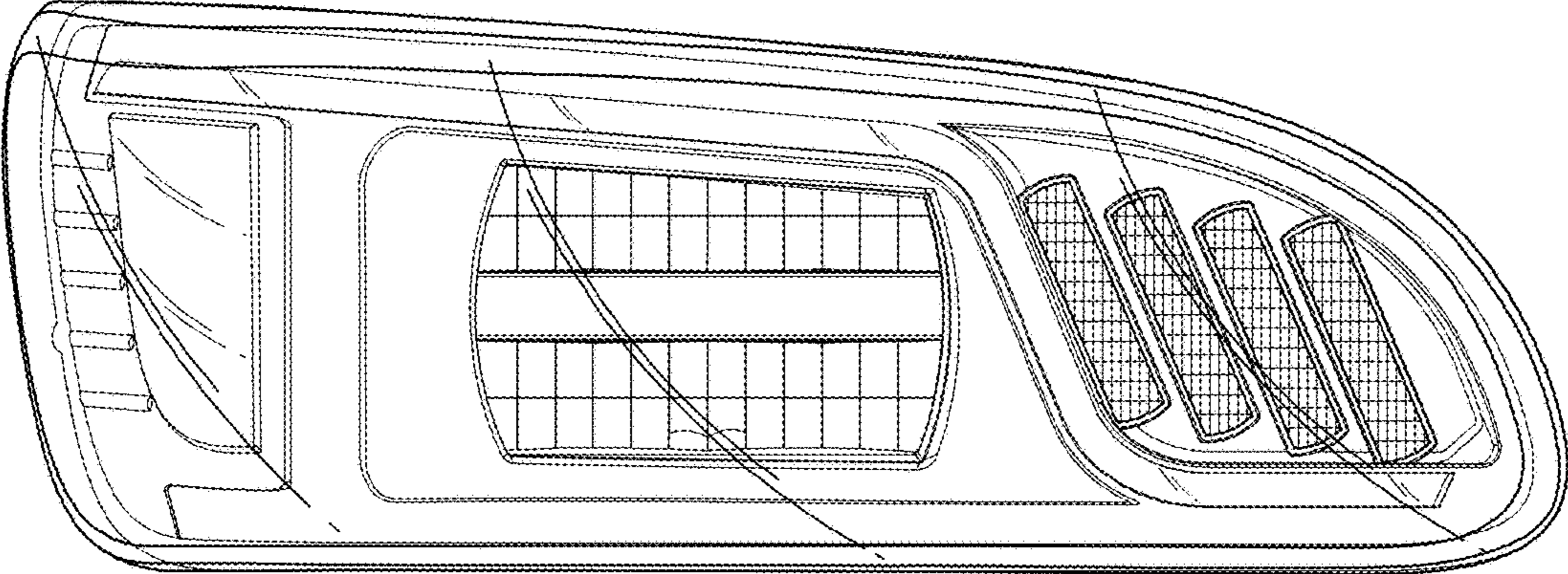

FIG. 2

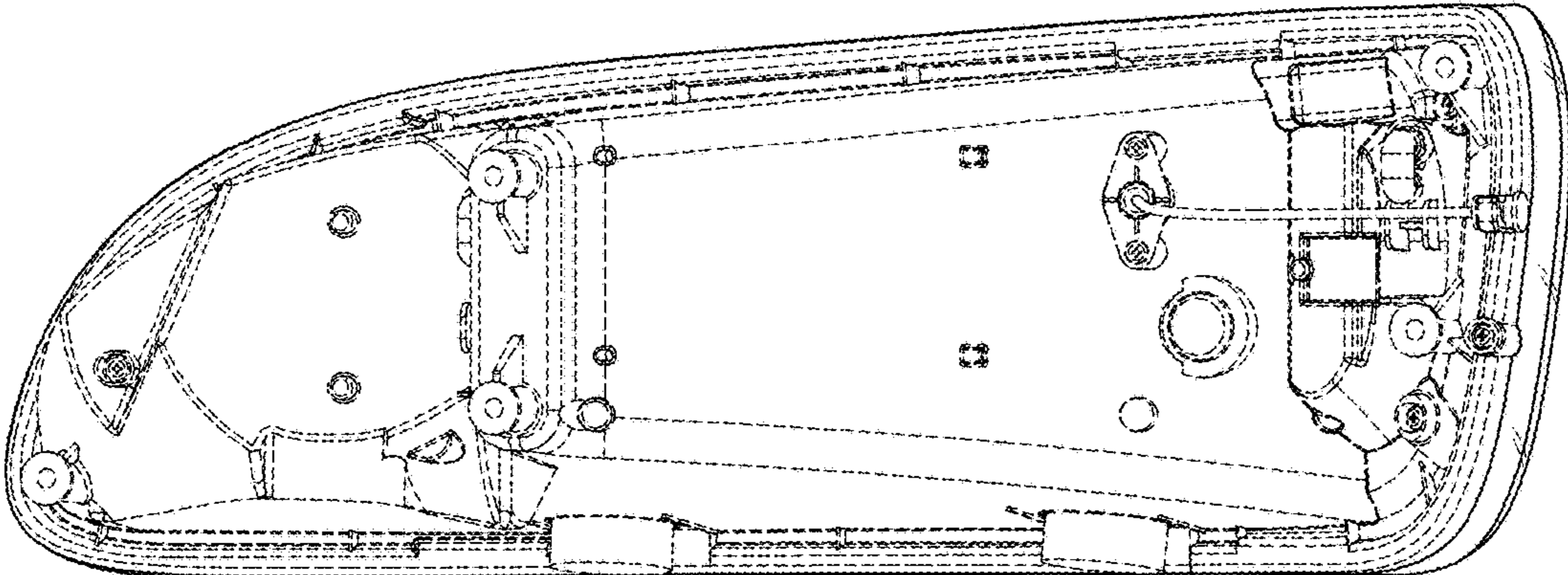

FIG. 3

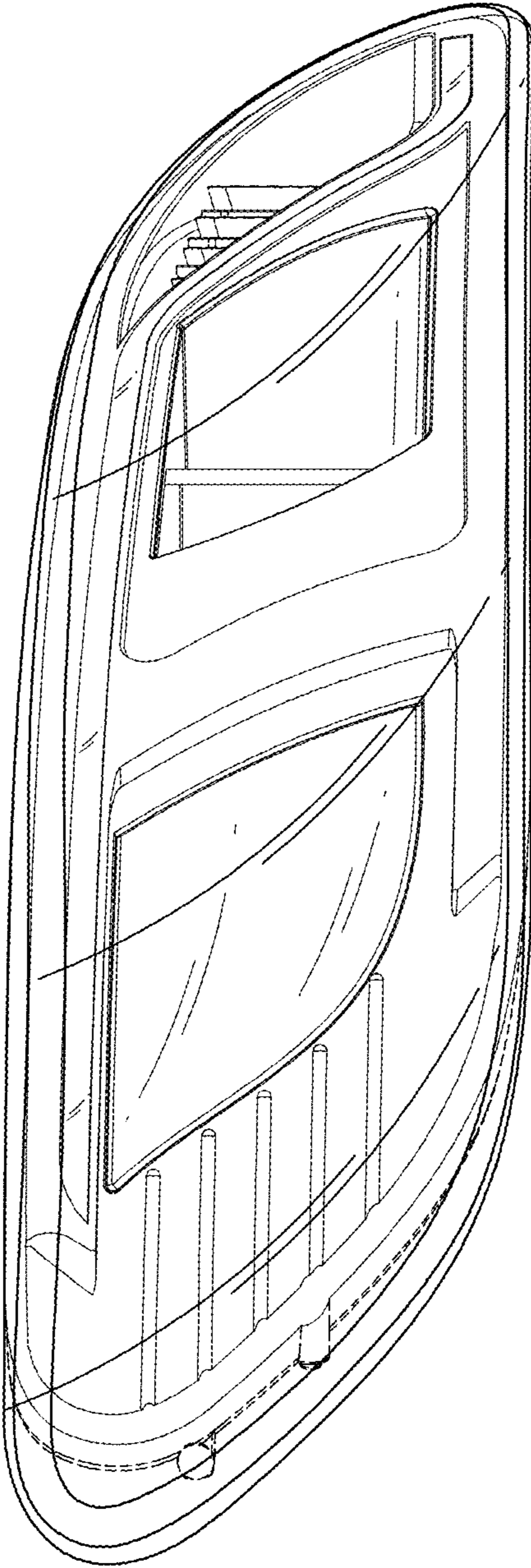

FIG.4

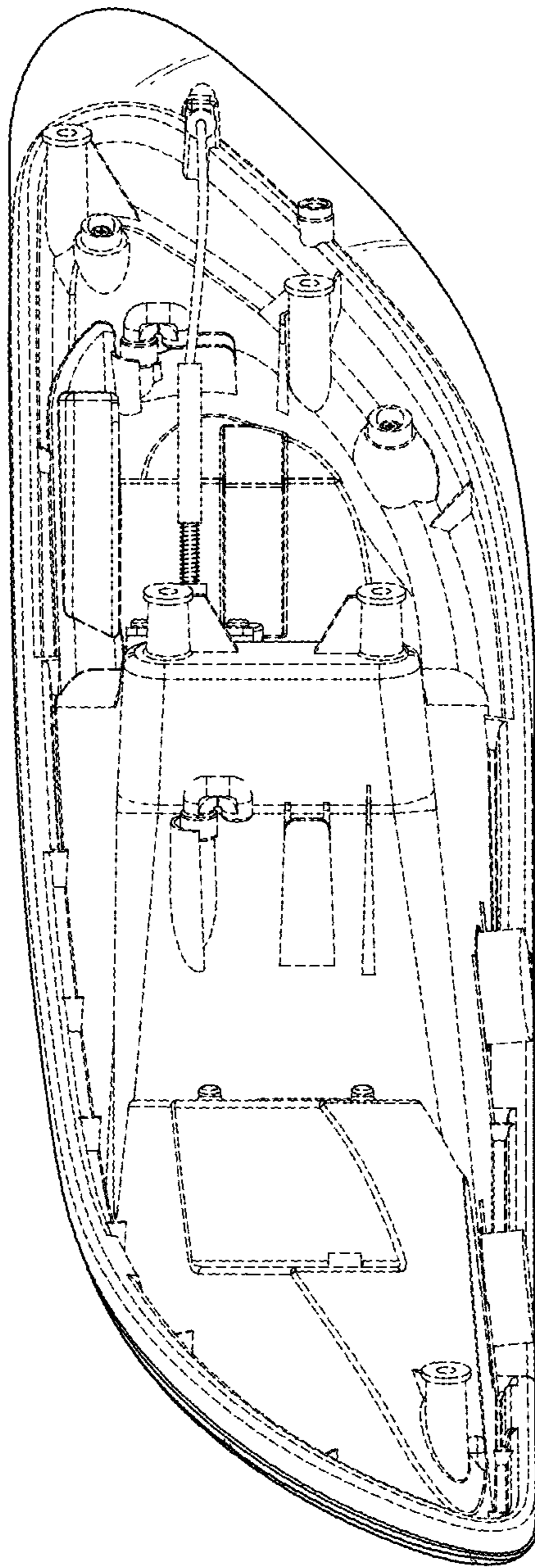

FIG.5

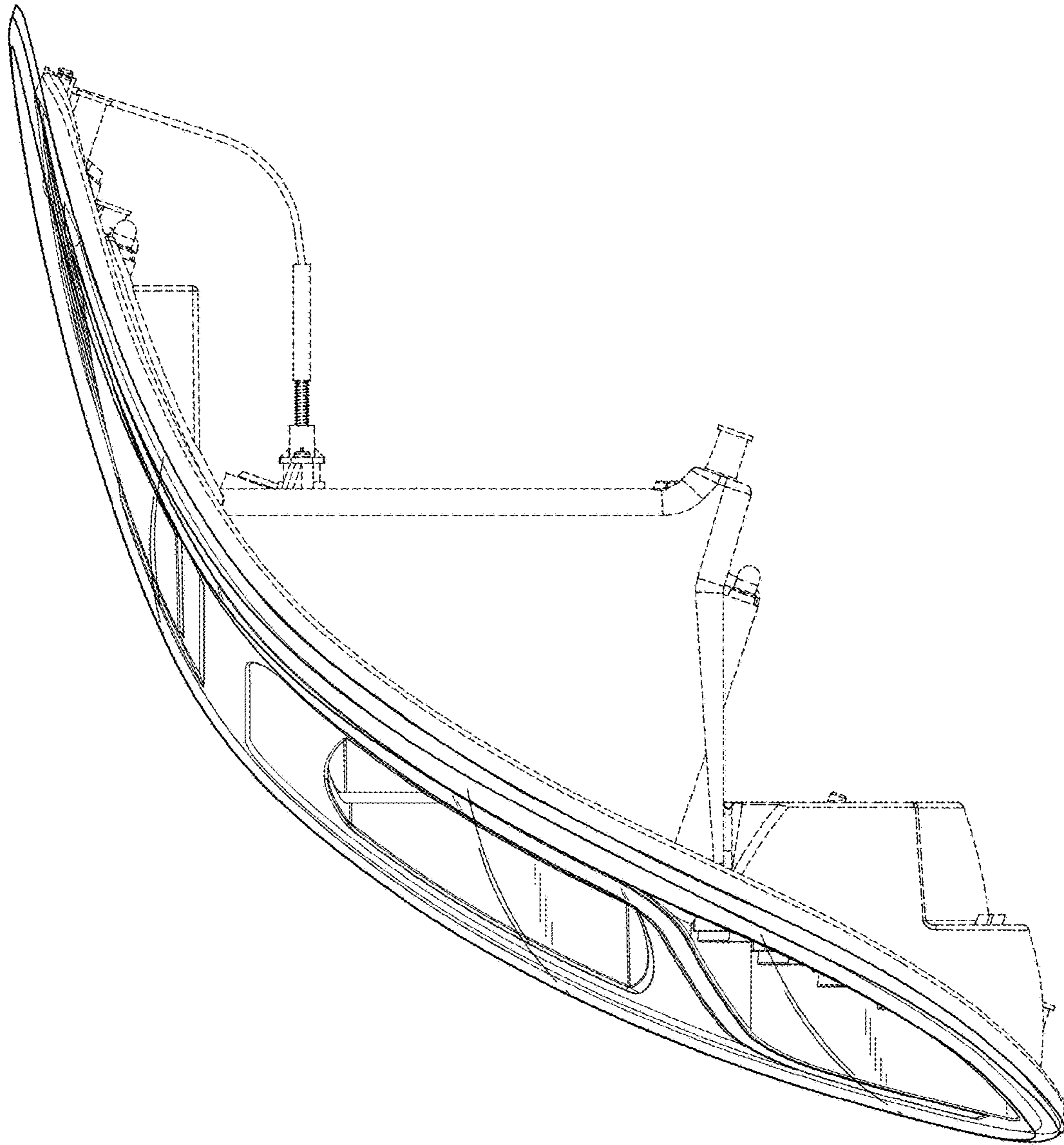

FIG.6

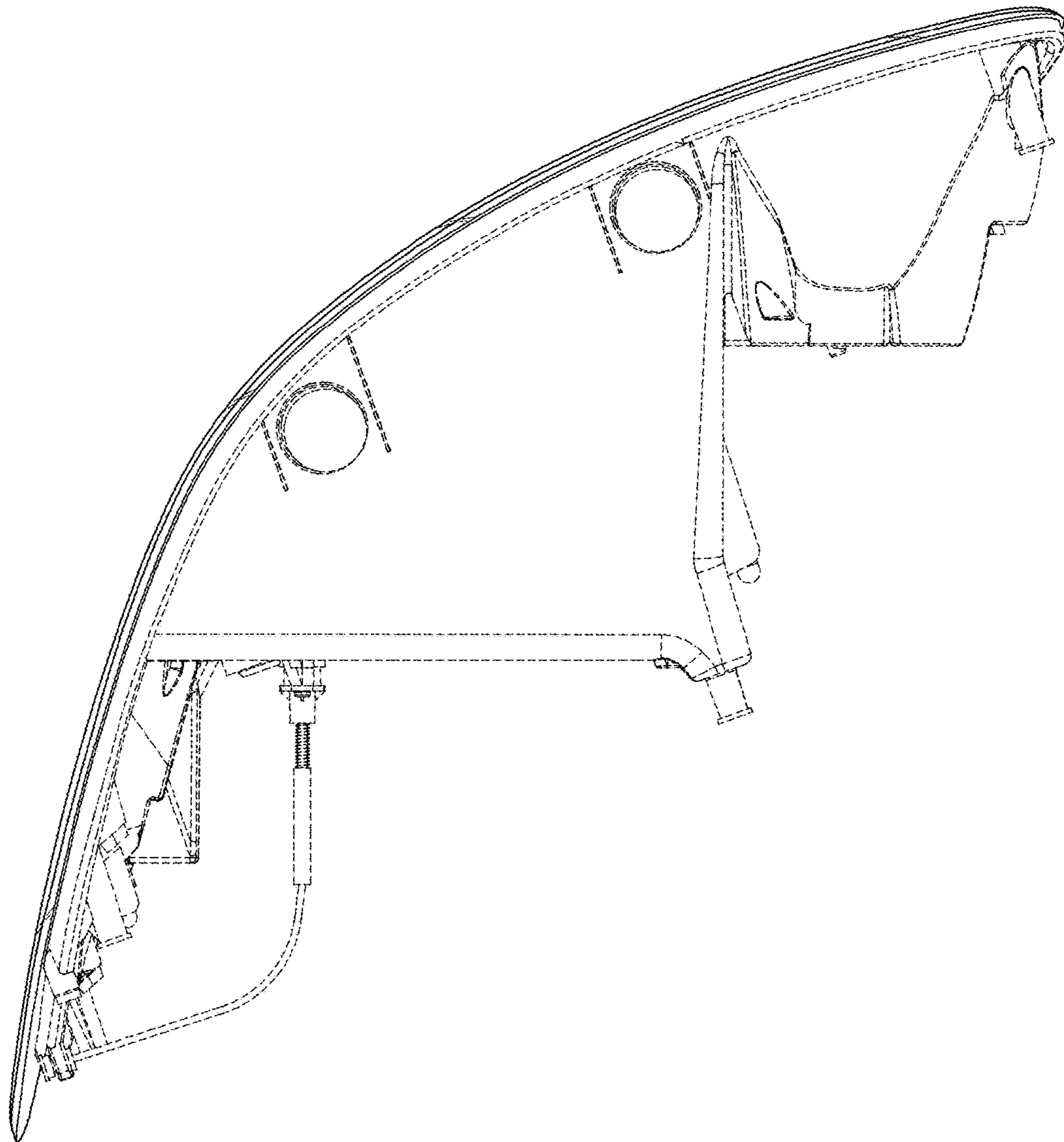

FIG.7