



US00D858791S

(12) **United States Design Patent** (10) **Patent No.:** **US D858,791 S**  
**LiCalzi et al.** (45) **Date of Patent:** **\*\* Sep. 3, 2019**

(54) **SYSTEM INCLUDING MULTIPLE INSTRUMENT MODULES AND ARRANGEMENT THEREOF**

(71) Applicant: **Siemens Healthcare Diagnostics Inc.**, Tarrytown, NY (US)

(72) Inventors: **Daniel LiCalzi**, New York, NY (US); **Youngsang Lee**, Flushing, NY (US); **Robert Faranda**, Boxborough, MA (US); **Richard Watson**, Norwell, MA (US); **Justin Cumming**, Topsfield, MA (US); **Scott Salmon**, Tenafly, NJ (US); **Josh Hartl**, Philadelphia, PA (US)

(73) Assignee: **Siemens Healthcare Diagnostics Inc.**, Tarrytown, NY (US)

(\*\*) Term: **15 Years**

(21) Appl. No.: **29/635,513**

(22) Filed: **Jan. 31, 2018**

**Related U.S. Application Data**

(62) Division of application No. 29/569,429, filed on Jun. 27, 2016, now Pat. No. Des. 816,242.

(51) **LOC (12) Cl.** ..... **24-01**

(52) **U.S. Cl.**  
USPC ..... **D24/216**

(58) **Field of Classification Search**  
USPC ..... D24/216, 111, 127, 107, 169, 186, 217, D24/219, 223–224, 231–234; D10/46,  
(Continued)

(56) **References Cited**

**U.S. PATENT DOCUMENTS**

D645,367 S \* 9/2011 Hayashi ..... D10/81  
D669,189 S \* 10/2012 Liu ..... D24/216  
(Continued)

*Primary Examiner* — Wan Laymon  
*Assistant Examiner* — Mark Booker

(57) **CLAIM**

We claim the ornamental design for an system including multiple instrument modules and arrangement thereof, as shown and described.

**DESCRIPTION**

FIG. 1 is a front perspective view of a system including multiple instrument modules and arrangement thereof in accordance with a first embodiment;  
FIG. 2 is a rear perspective view of a system including multiple instrument modules and arrangement thereof;  
FIG. 3 is a front elevational view of a system including multiple instrument modules and arrangement thereof;  
FIG. 4 is a rear elevational view of a system including multiple instrument modules and arrangement thereof;  
FIG. 5 is a left side elevational view of a system including multiple instrument modules and arrangement thereof;  
FIG. 6 is a right side elevational view of a system including multiple instrument modules and arrangement thereof;  
FIG. 7 is a top view of a system including multiple instrument modules and arrangement thereof;  
FIG. 8 is a bottom view of a system including multiple instrument modules and arrangement thereof;  
FIG. 9 is a front perspective view of a system including multiple instrument modules and arrangement thereof in accordance with a second embodiment;  
FIG. 10 is a front elevational view of a system including multiple instrument modules and arrangement thereof;  
FIG. 11 a rear elevational view of a system including multiple instrument modules and arrangement thereof;  
FIG. 12 is a left side elevational view of a system including multiple instrument modules and arrangement thereof;  
FIG. 13 is a right side elevational view of a system including multiple instrument modules and arrangement thereof;  
FIG. 14 is a top view of a system including multiple instrument modules and arrangement thereof; and,  
FIG. 15 is a bottom view of a system including multiple instrument modules and arrangement thereof.  
The broken lines shown in the figures represent portions of the system including multiple instrument modules and arrangement thereof that form no part of the claimed design.

**1 Claim, 15 Drawing Sheets**

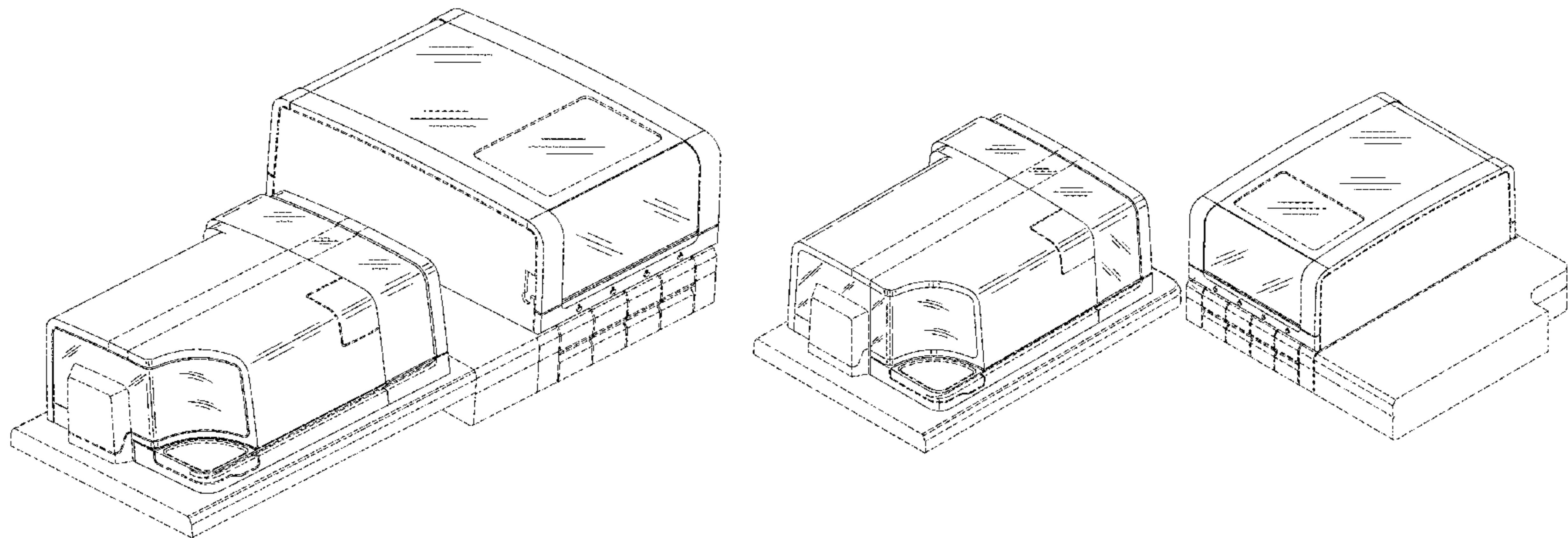

(58) **Field of Classification Search**  
 USPC ..... D10/70, 81, 97; 422/1, 62–65, 67, 68.1,  
                   422/70, 81, 129, 500, 506, 561,  
                   422/FOR. 106; 435/287.1, 287.3;  
                   436/43, 45, 47; 600/300, 301, 368, 372,  
                   600/481, 529, 544, 554, 561; 607/4, 5, 9,  
   607/30  
 CPC ... G01R 31/31907; B04B 13/00; B04B 15/00;  
           B04B 2005/0435; B04B 5/0421; A61B  
           5/157; G06F 19/366; B01D 21/262  
 See application file for complete search history.

(56) **References Cited**  
 U.S. PATENT DOCUMENTS

D676,143 S \* 2/2013 Liu ..... D24/216  
 D676,568 S \* 2/2013 Liu ..... D24/216

D685,483 S \* 7/2013 LiCalzi ..... D24/216  
 D735,878 S \* 8/2015 Chang ..... D24/216  
 D738,243 S \* 9/2015 Selberg ..... D10/81  
 D804,681 S \* 12/2017 LiCalzi ..... D24/216  
 D806,259 S \* 12/2017 LiCalzi ..... D24/216  
 D810,956 S \* 2/2018 LiCalzi ..... D24/216  
 D812,241 S \* 3/2018 LiCalzi ..... D24/216  
 D813,410 S \* 3/2018 LiCalzi ..... D24/216  
 D816,238 S \* 4/2018 LiCalzi ..... D24/216  
 D816,239 S \* 4/2018 LiCalzi ..... D24/216  
 D816,240 S \* 4/2018 LiCalzi ..... D24/216  
 D816,241 S \* 4/2018 LiCalzi ..... D24/216  
 D816,242 S \* 4/2018 LiCalzi ..... D24/216  
 D816,859 S \* 5/2018 LiCalzi ..... D24/216  
 D816,860 S \* 5/2018 LiCalzi ..... D24/216  
 D820,995 S \* 6/2018 LiCalzi ..... D24/216  
 D826,423 S \* 8/2018 LiCalzi ..... D24/216  
 D826,424 S \* 8/2018 LiCalzi ..... D24/216

\* cited by examiner

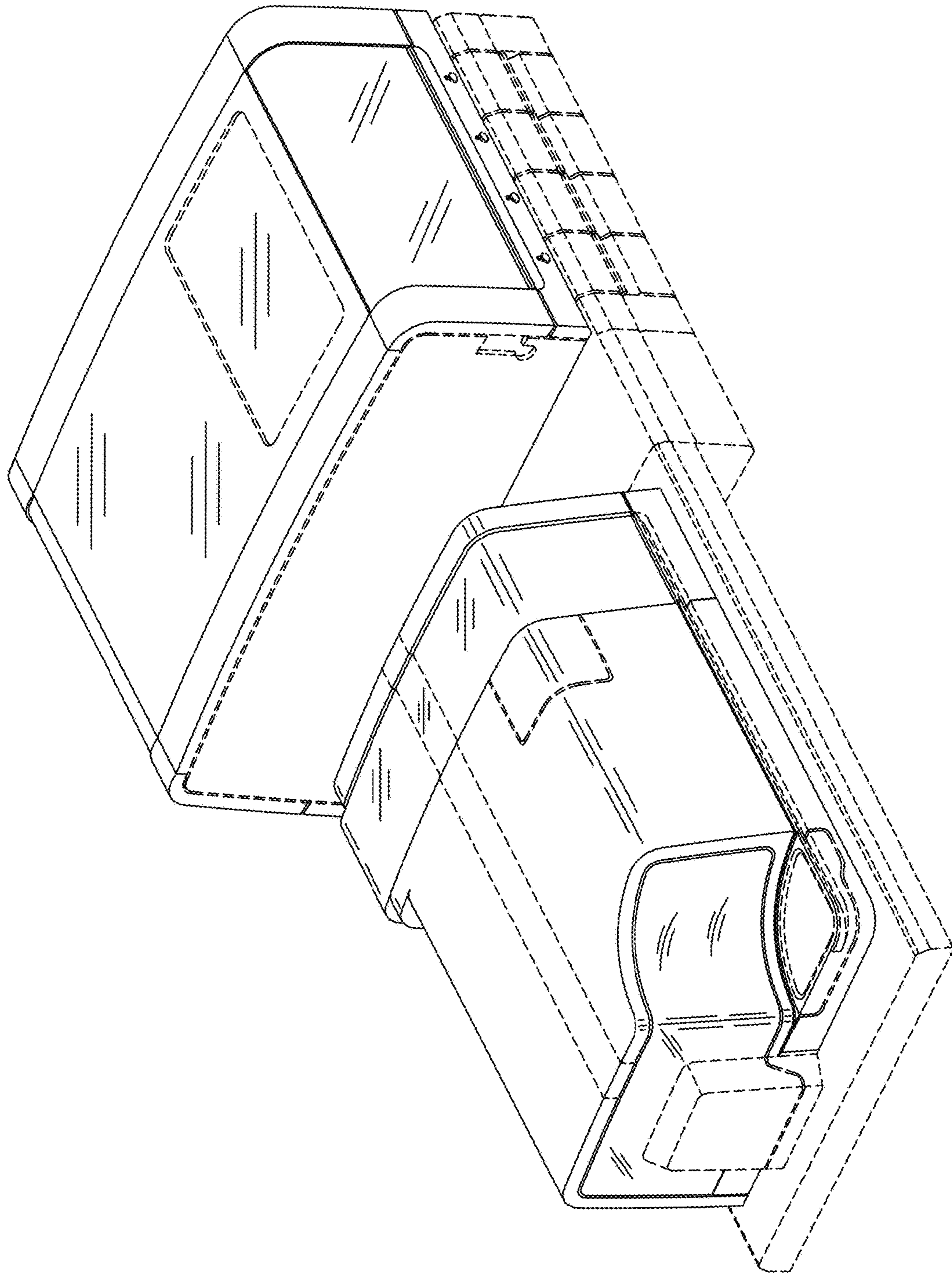

FIG. 1

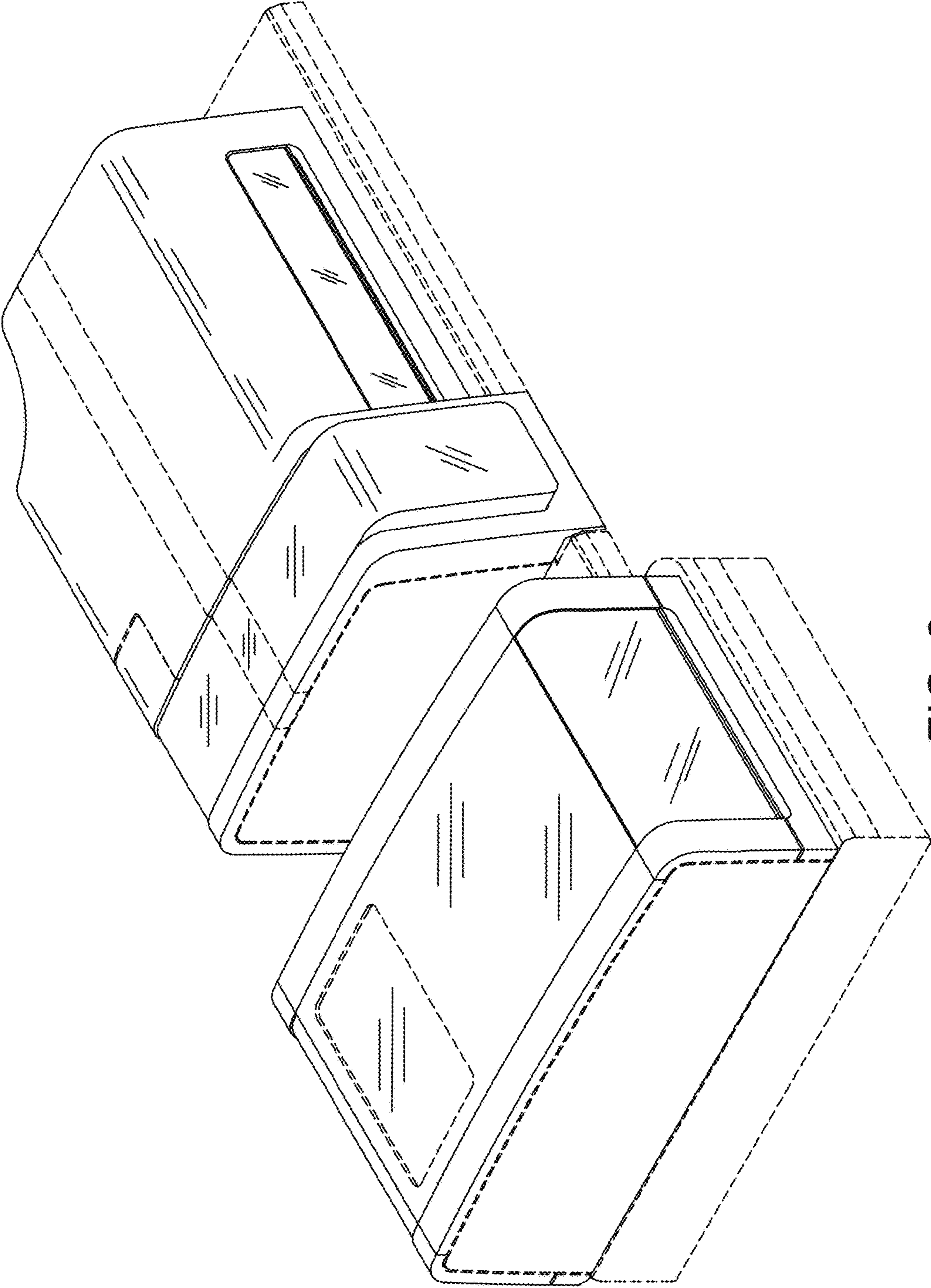

FIG. 2

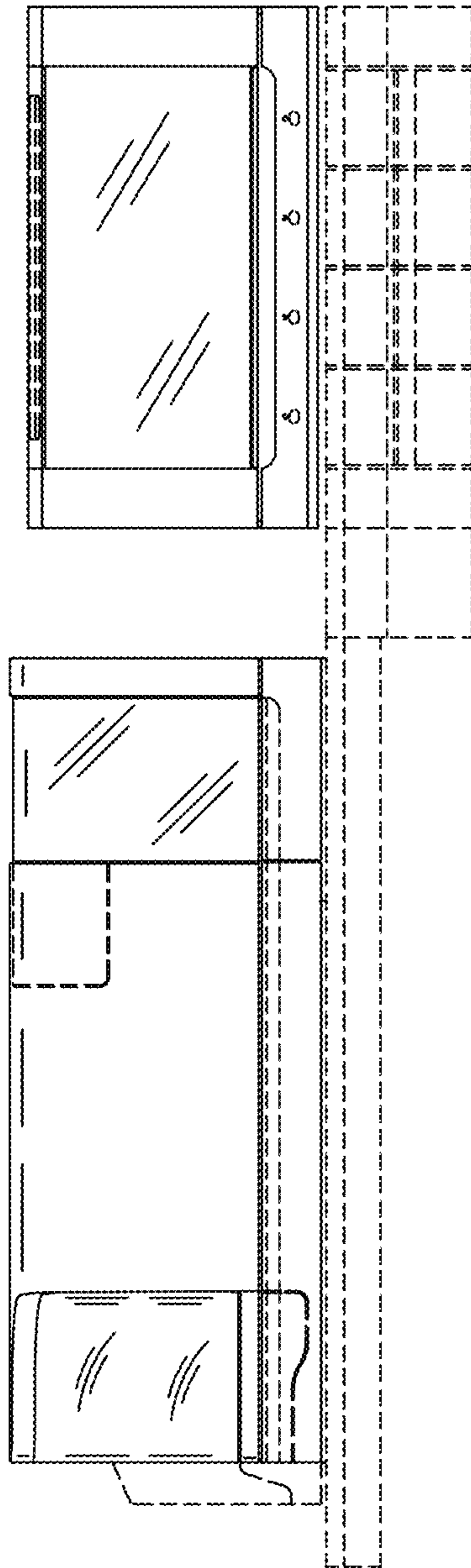

FIG. 3

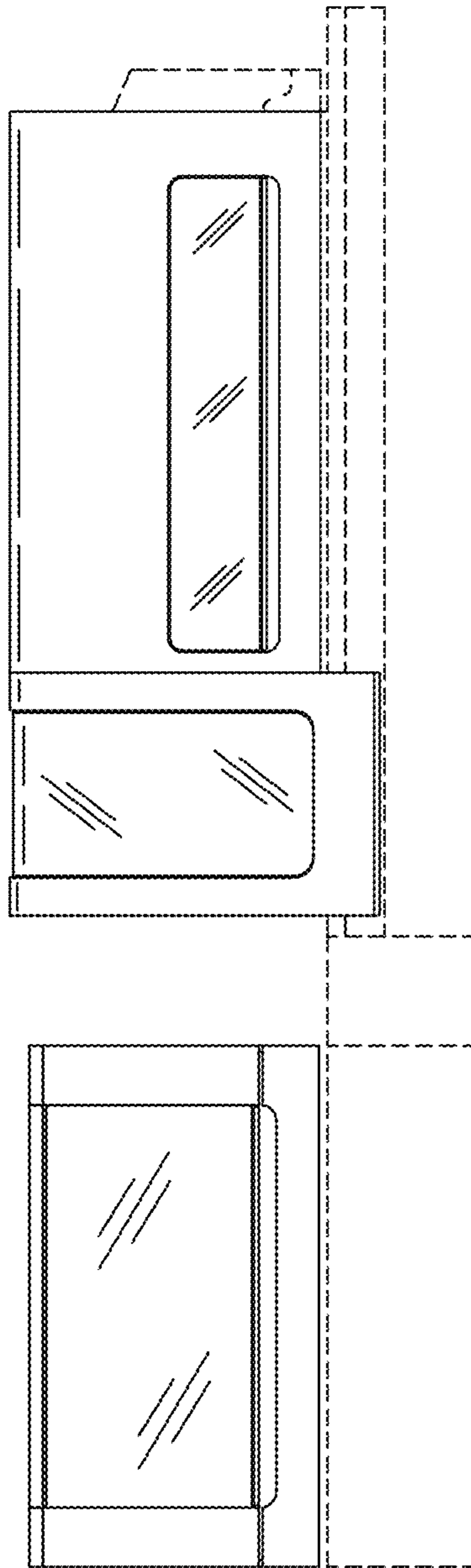

FIG. 4

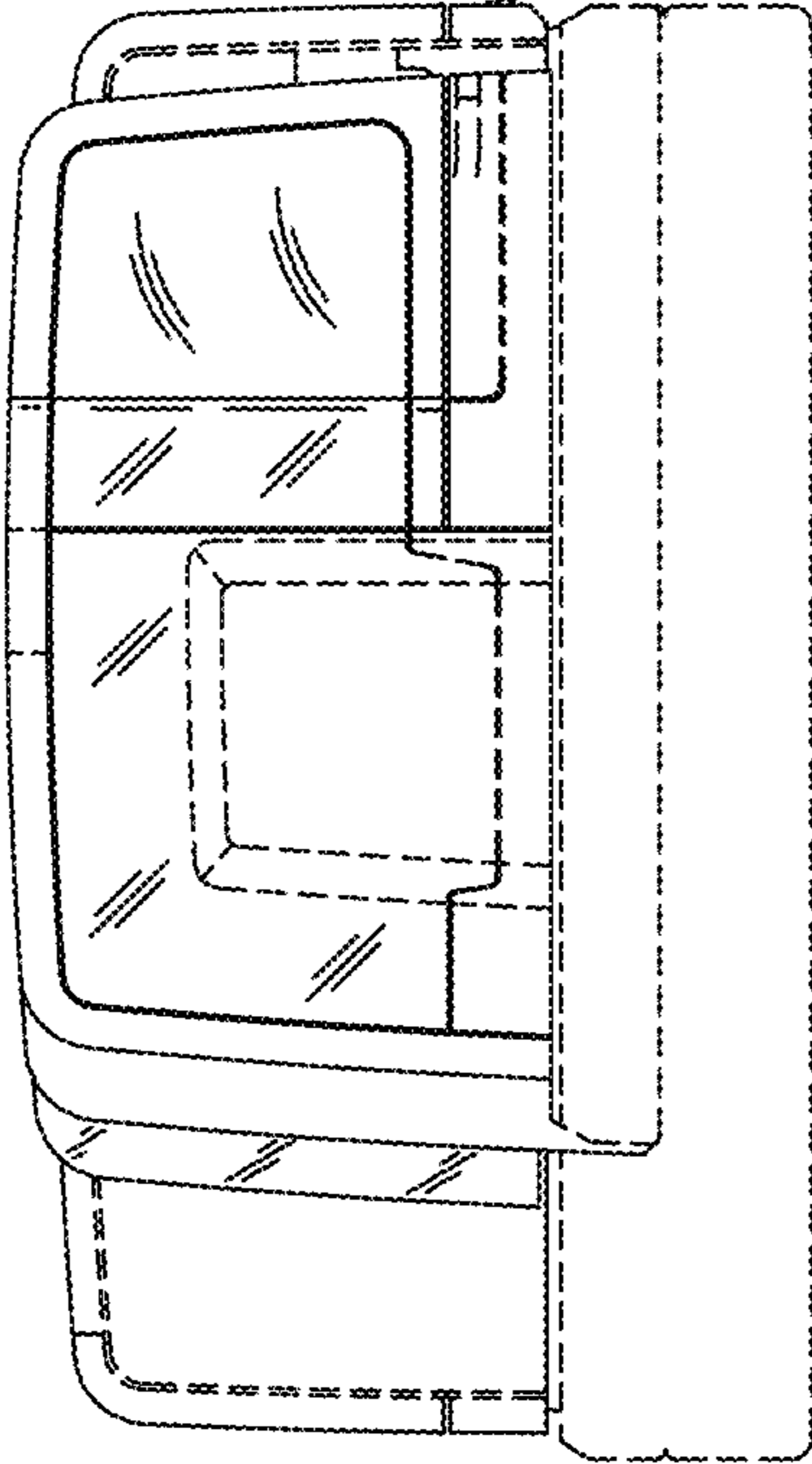

FIG. 5

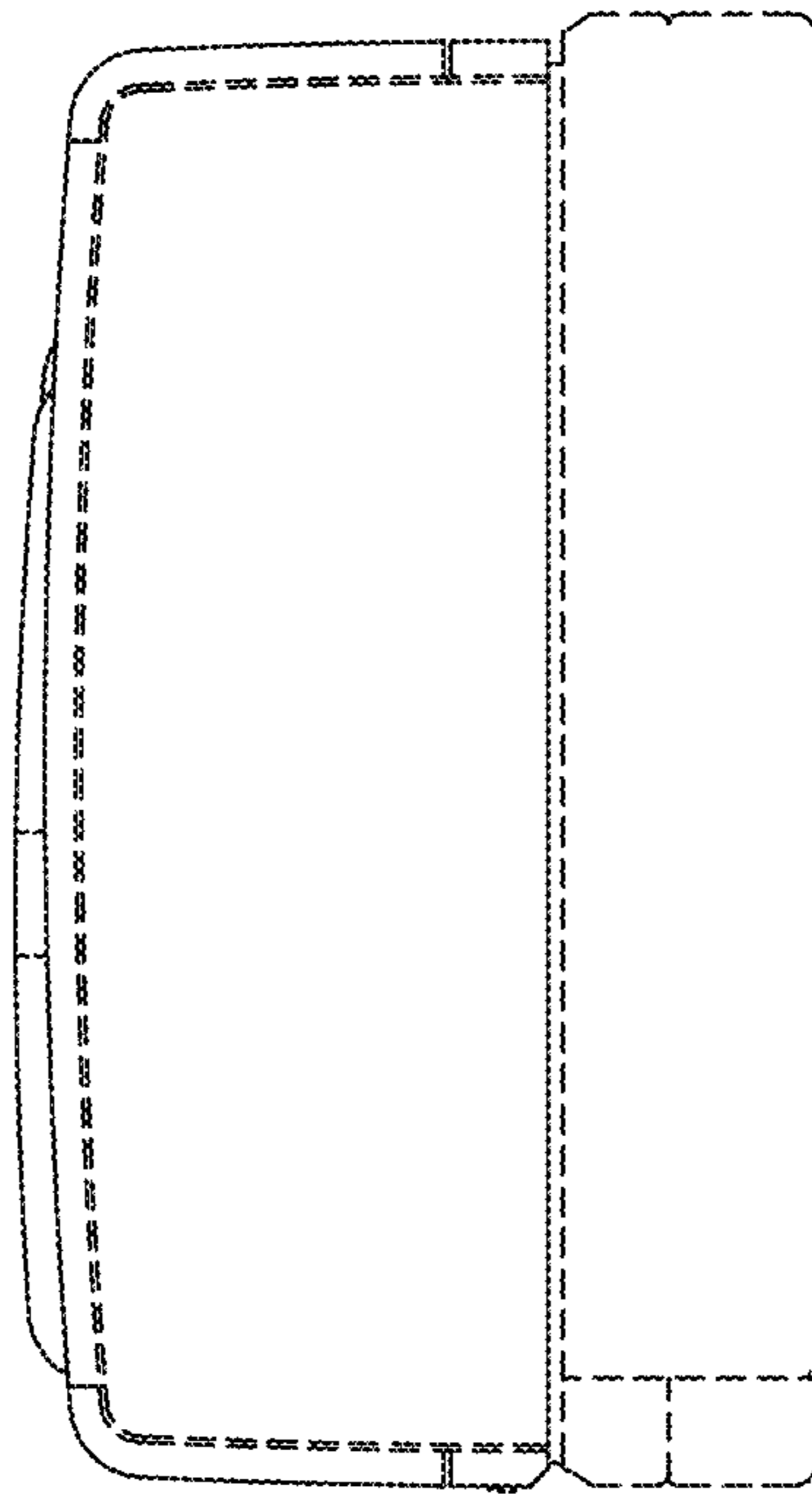

FIG. 6



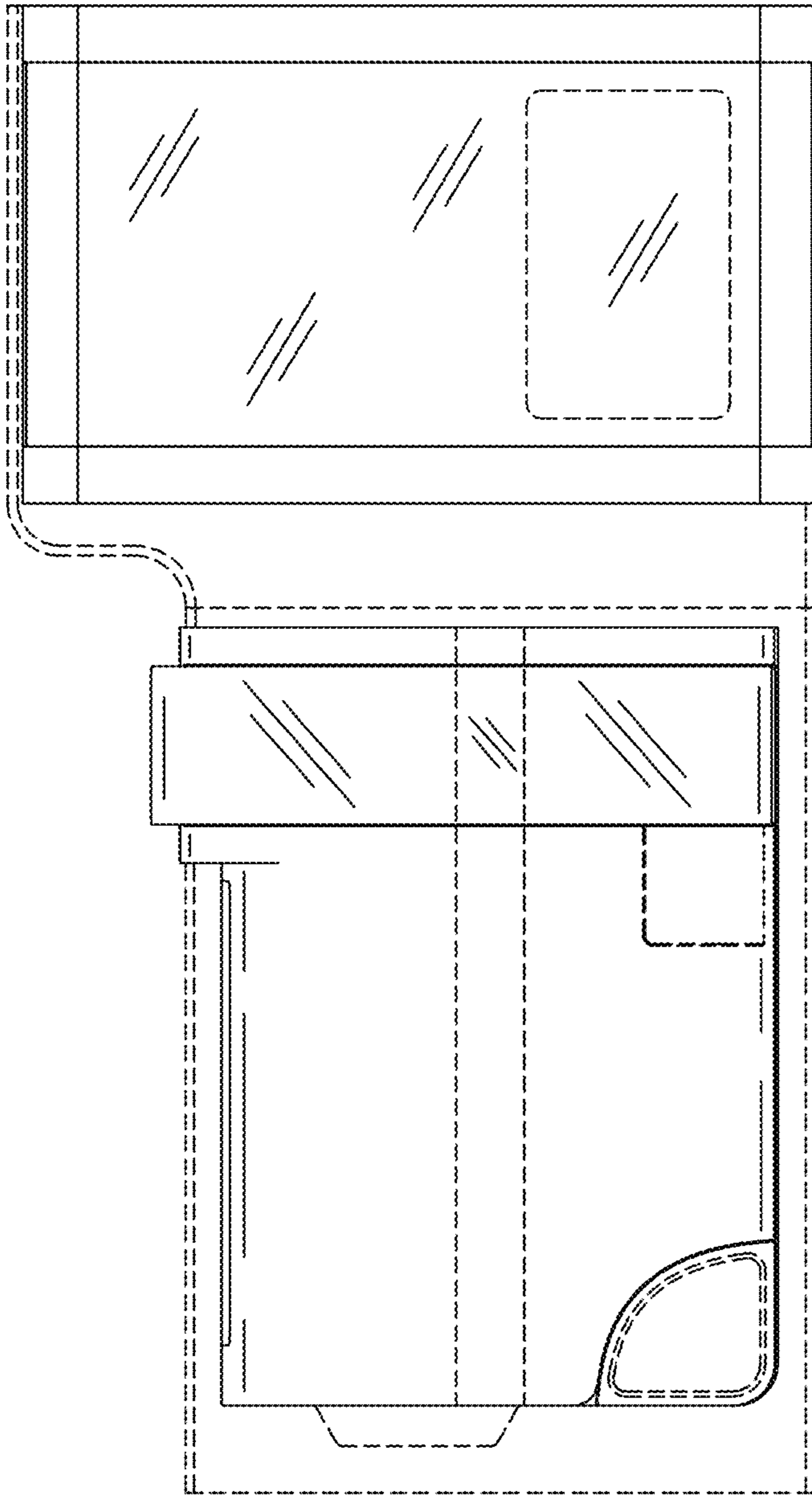

FIG. 7

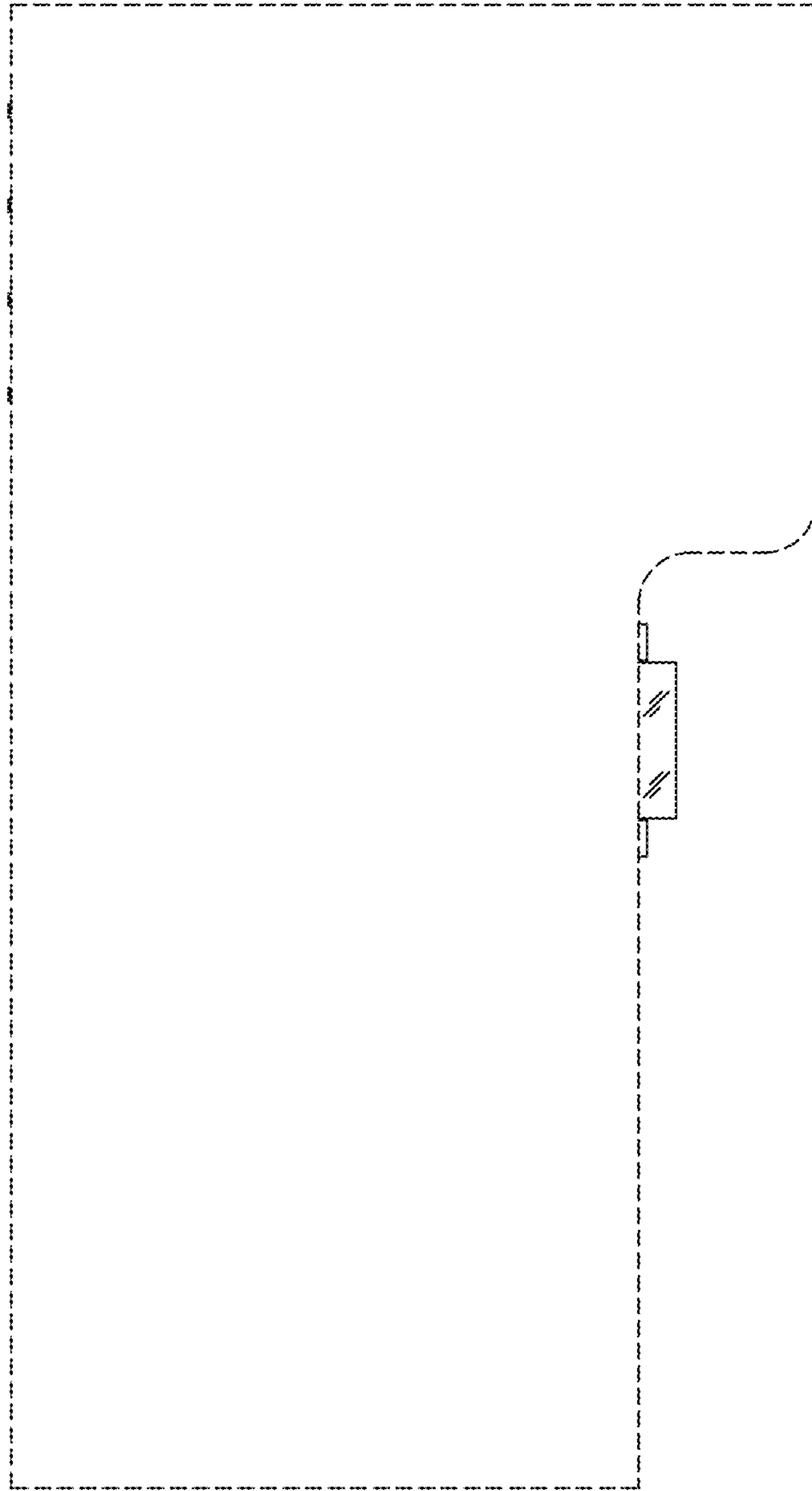

FIG. 8

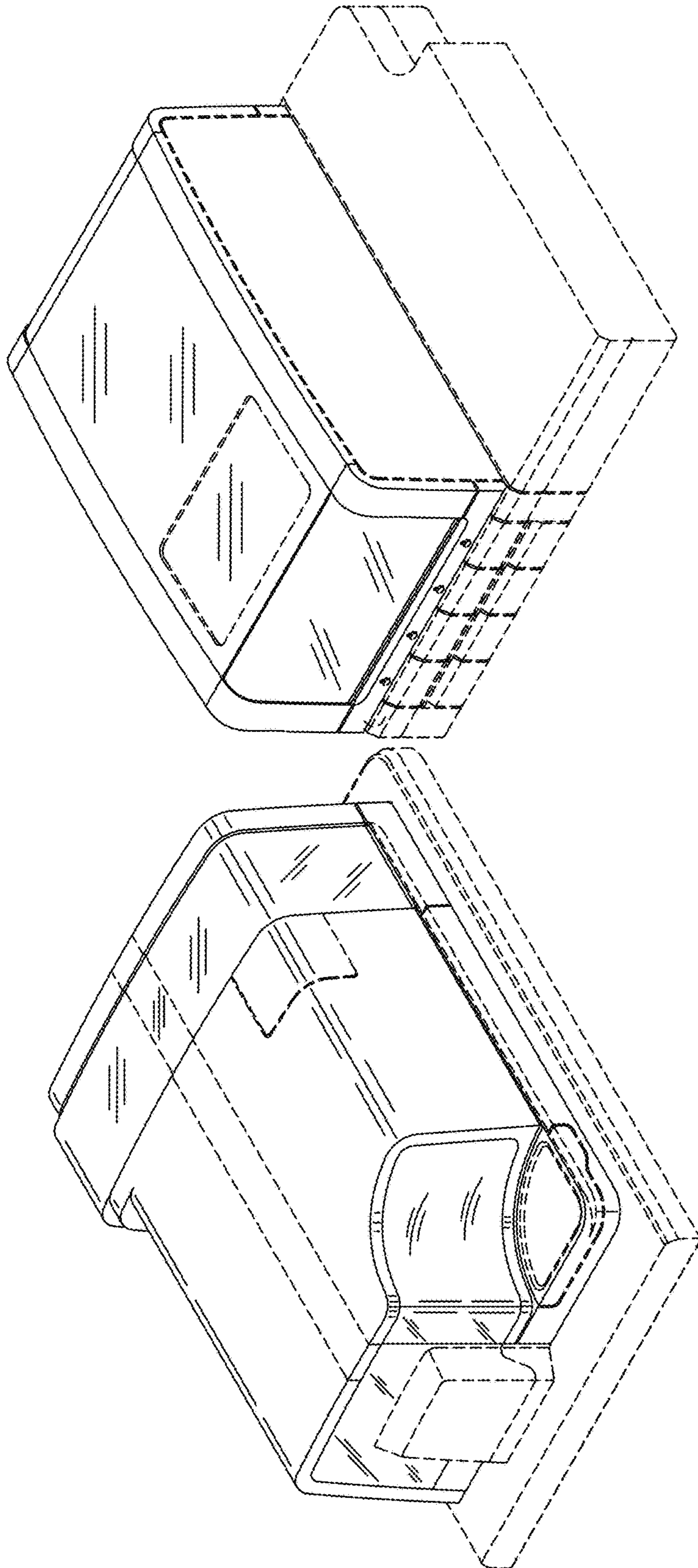

FIG. 9

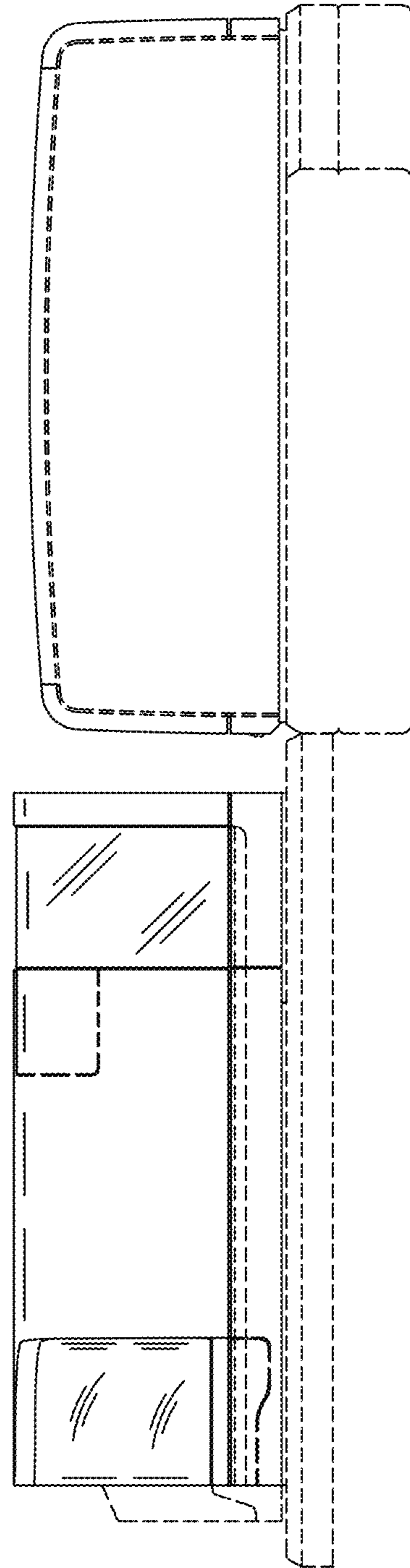

FIG. 10

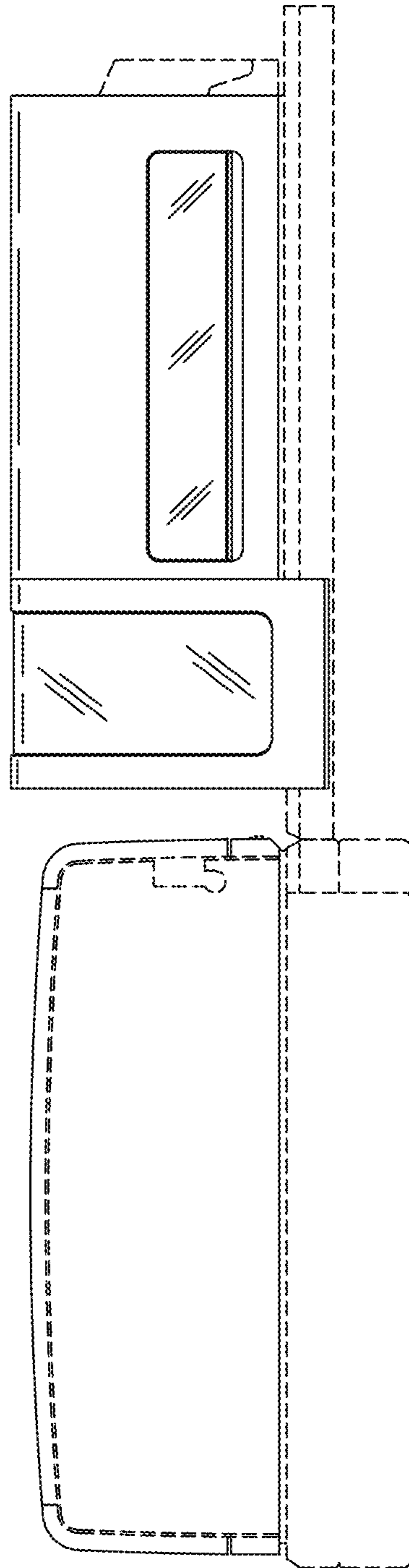

FIG. 11

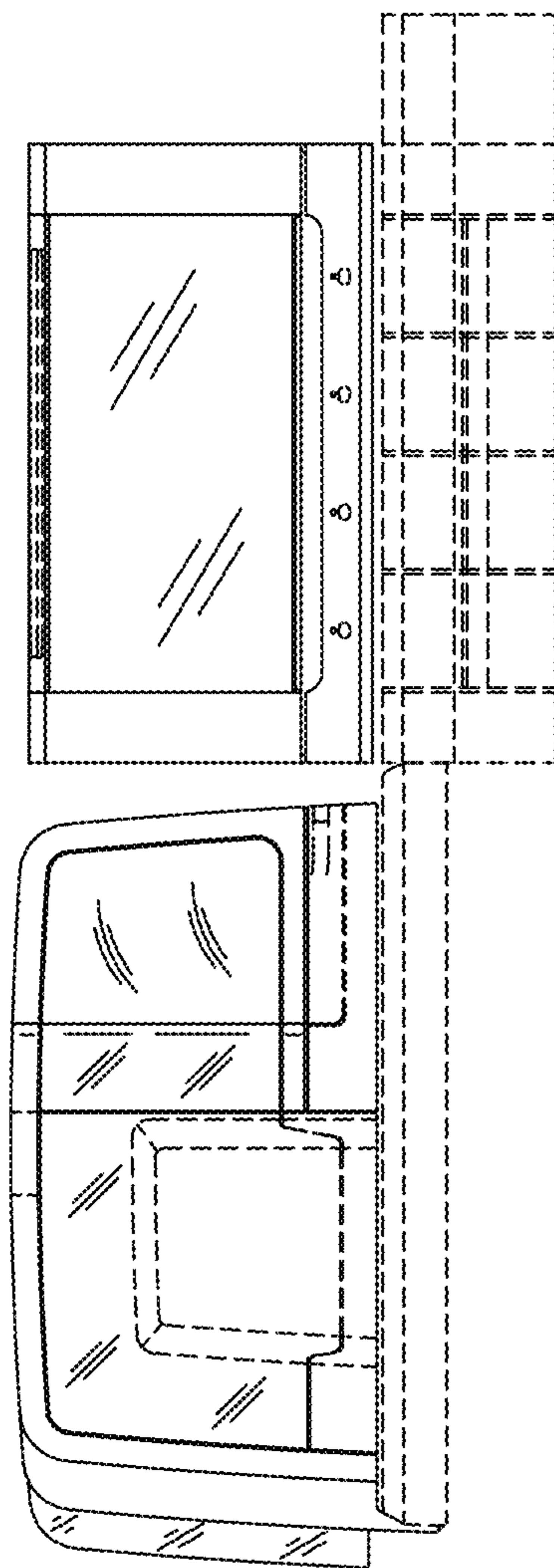

FIG. 12

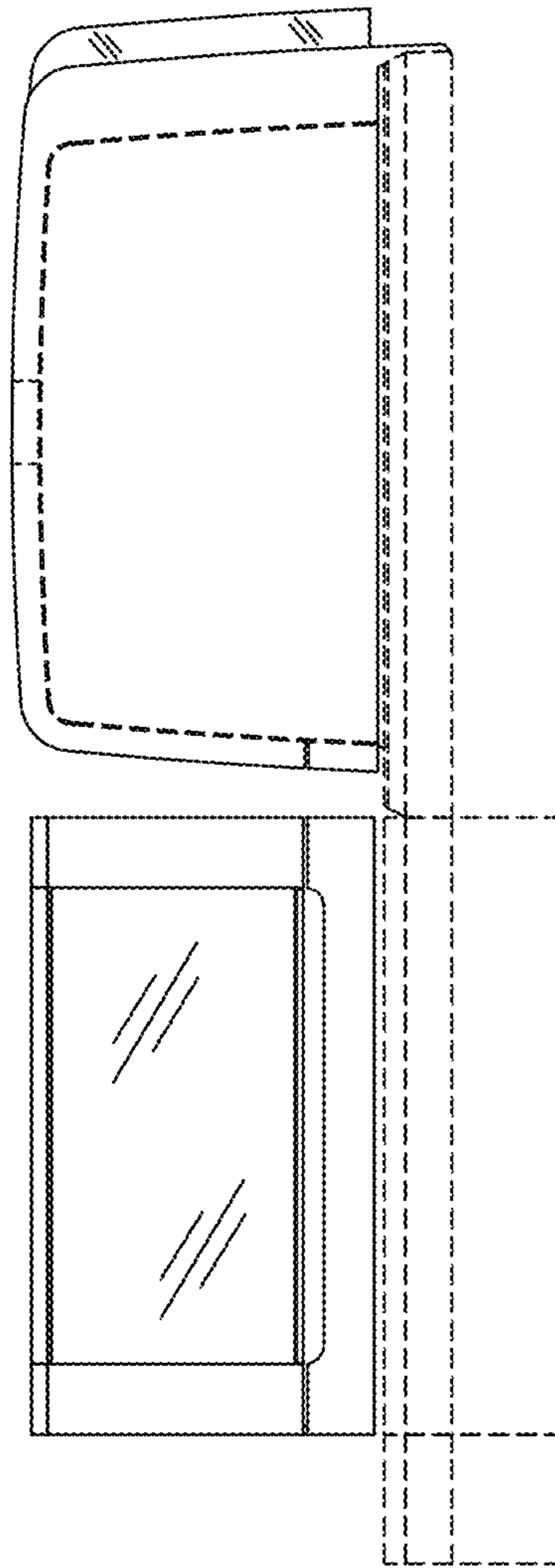

FIG. 13

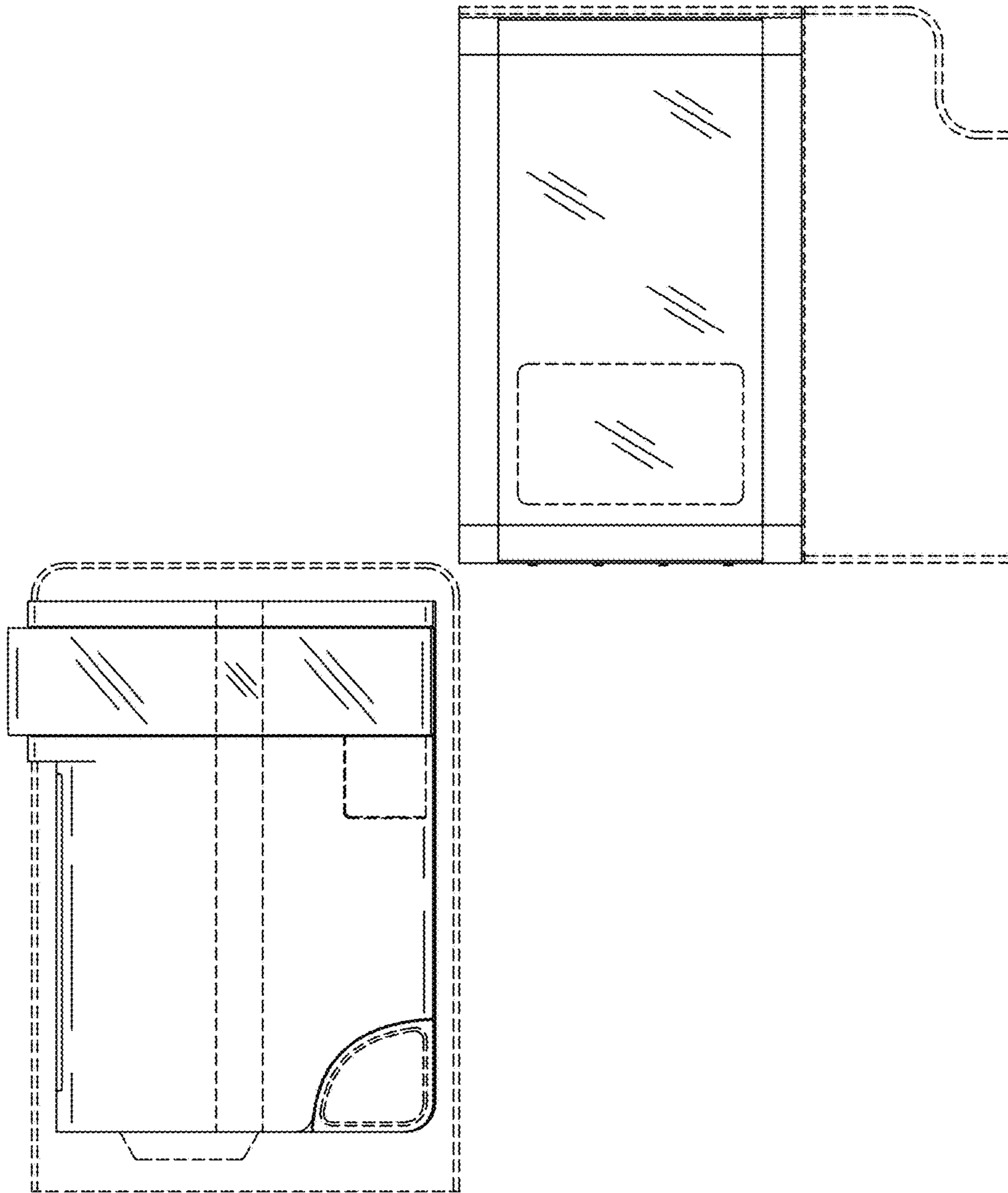

FIG. 14



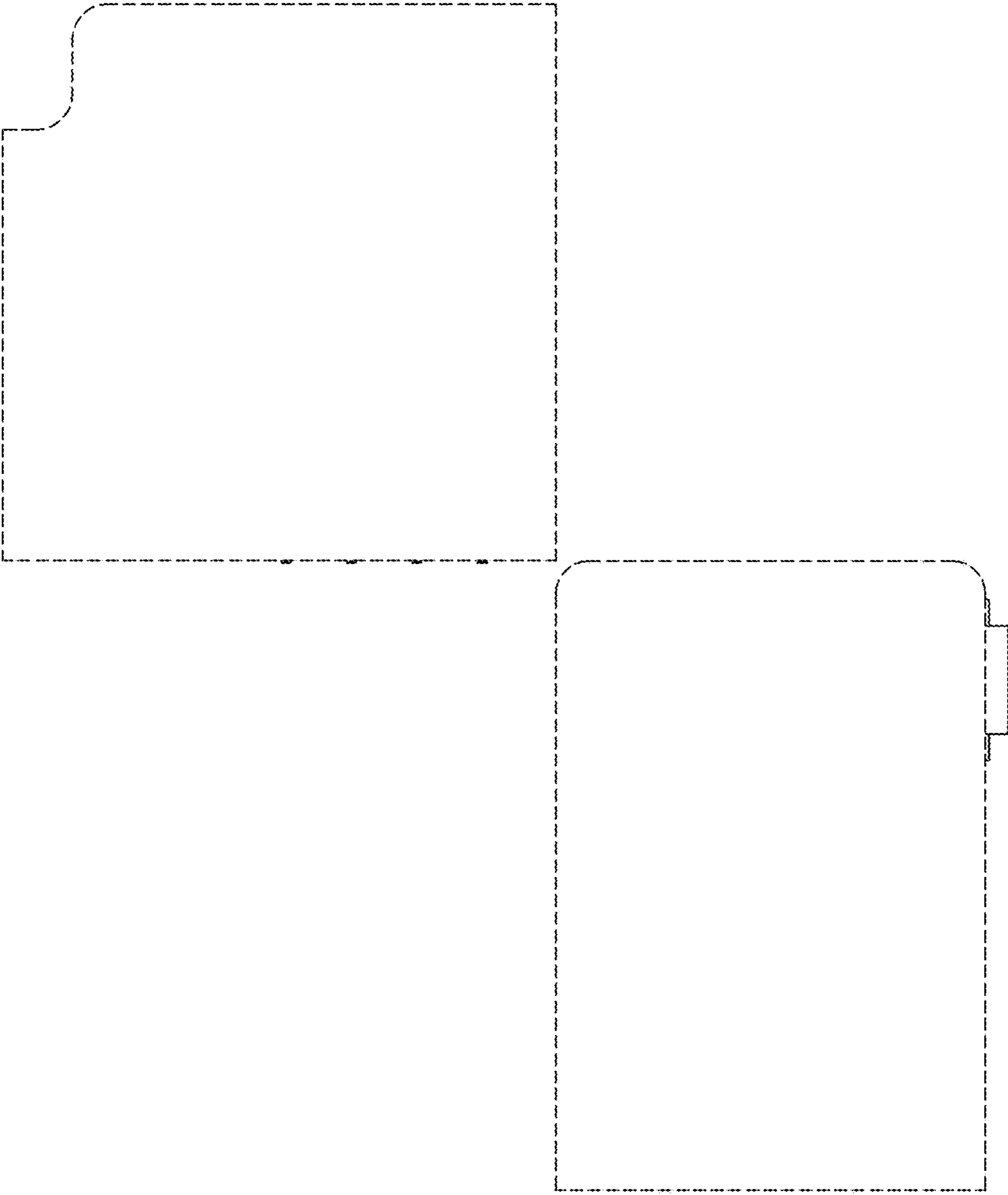

FIG. 15