



US00D858785S

(12) **United States Design Patent**
Barber et al.

(10) **Patent No.:** **US D858,785 S**
(45) **Date of Patent:** **** Sep. 3, 2019**

(54) **BATTERY POWERED RECHARGEABLE
HANDWARMER**

D794,813 S 8/2017 Zsolcsak et al.
D801,624 S 11/2017 Zsolcsak et al.
2012/0065716 A1* 3/2012 Gill A61F 7/0085
607/107

(71) Applicant: **Zippo Manufacturing Company,**
Bradford, PA (US)

(72) Inventors: **Brian J. Barber,** Cyclone, PA (US);
Justan D. Studley, Gowanda, NY (US);
James A. Hofman, Eden Prairie, MN
(US)

(73) Assignee: **Zippo Manufacturing Company,**
Bradford, PA (US)

(**) Term: **15 Years**

(21) Appl. No.: **29/646,238**

(22) Filed: **May 2, 2018**

(51) **LOC (12) Cl.** **24-04**

(52) **U.S. Cl.**
USPC **D24/206**

(58) **Field of Classification Search**
USPC D24/206–208, 200; 601/15, 40, 64;
602/2, 7; 606/27
CPC .. A61F 7/00; A61F 7/007; A61F 7/034; A61F
7/0085; A61F 2007/0001; A61F
2007/0036; A61F 2007/0078; A61F
2007/0085; A61F 2007/0087
See application file for complete search history.

(56) **References Cited**

U.S. PATENT DOCUMENTS

D246,173 S * 10/1977 Levin D24/200
D263,416 S * 3/1982 Saire D24/206
D698,931 S 2/2014 Wang
D762,308 S 7/2016 Wang
D764,065 S * 8/2016 Schaberreiter D24/206
D791,431 S 7/2017 Tingler

OTHER PUBLICATIONS

Zippo REchargeable Hand Warmers. 2017. Retrieved on May 8,
2019. Retrieved from the Internet: https://www.amazon.com/exec/obidos/ASIN/B075SJ6T7R/ezvid02-20.*

(Continued)

Primary Examiner — Wan Laymon

(74) *Attorney, Agent, or Firm* — Hodgson Russ LLP

(57) **CLAIM**

The ornamental design for a battery powered rechargeable
handwarmer, as shown and described.

DESCRIPTION

FIG. 1 is a front perspective view of a first embodiment of
a battery powered rechargeable handwarmer;
FIG. 2 is a left side elevation view thereof;
FIG. 3 is a right side elevation view thereof;
FIG. 4 is a front elevation view thereof;
FIG. 5 is a rear elevation view thereof;
FIG. 6 is a top plan view thereof;
FIG. 7 is a bottom plan view thereof;
FIG. 8 is a front perspective view of a second embodiment
of a battery powered rechargeable handwarmer;
FIG. 9 is a left side elevation view thereof;
FIG. 10 is a right side elevation view thereof;
FIG. 11 is a front elevation view thereof;
FIG. 12 is a rear elevation view thereof;
FIG. 13 is a top plan view thereof; and,
FIG. 14 is a bottom plan view thereof.

The broken lines illustrate unclaimed portions of the battery
powered rechargeable handwarmer or environmental fea-
tures that form no part of the claimed design.

1 Claim, 10 Drawing Sheets

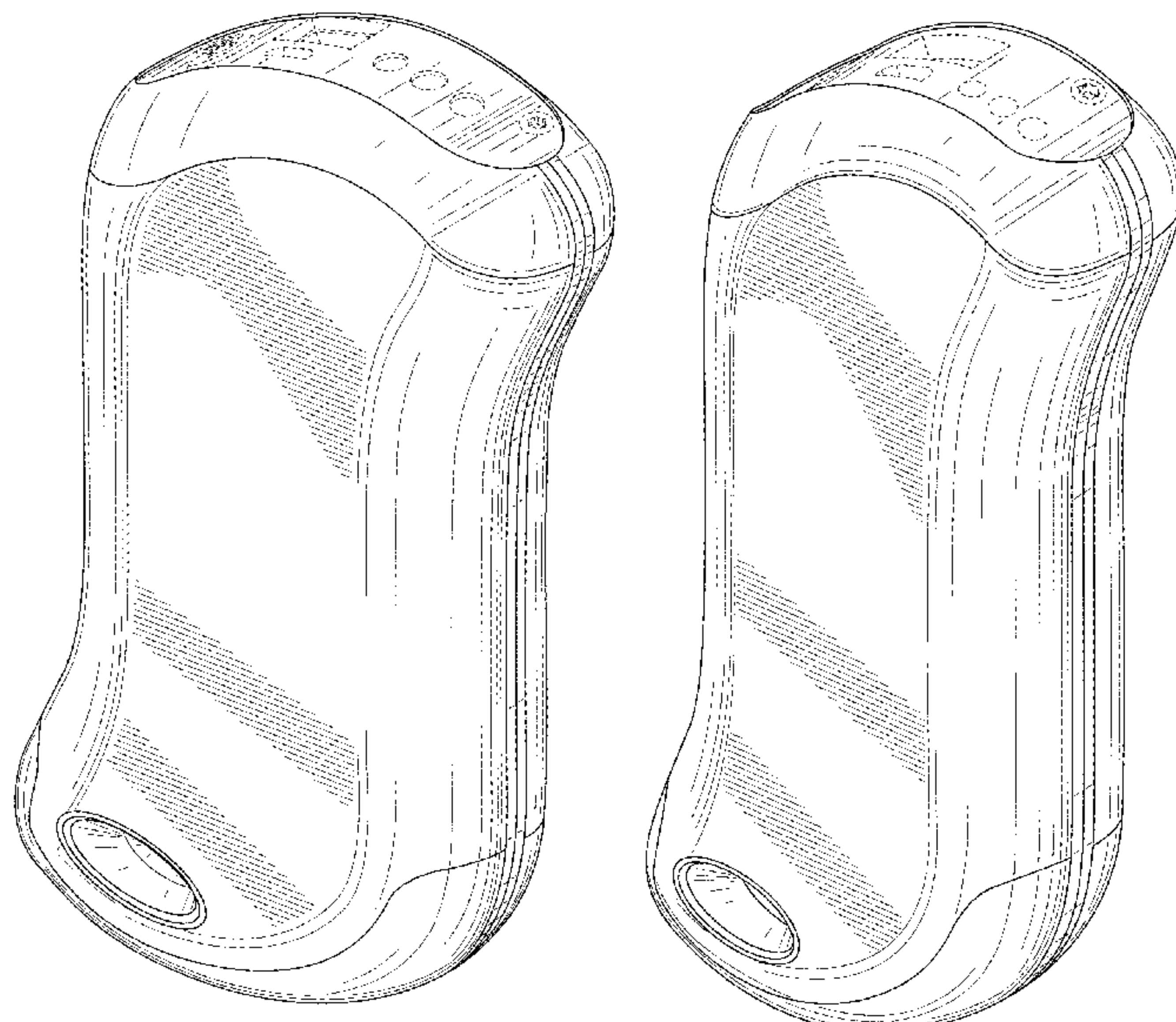

(56)

References Cited

OTHER PUBLICATIONS

Silver HeatBank™ 9s Rechargeable Hand Warmer. Retrieved on May 8, 2019. Retrieved from the Internet:<https://www.zippo.com/collections/hand-warmers/products/silver-heatbank-9s-rechargeable-hand-warmer>.*

* cited by examiner

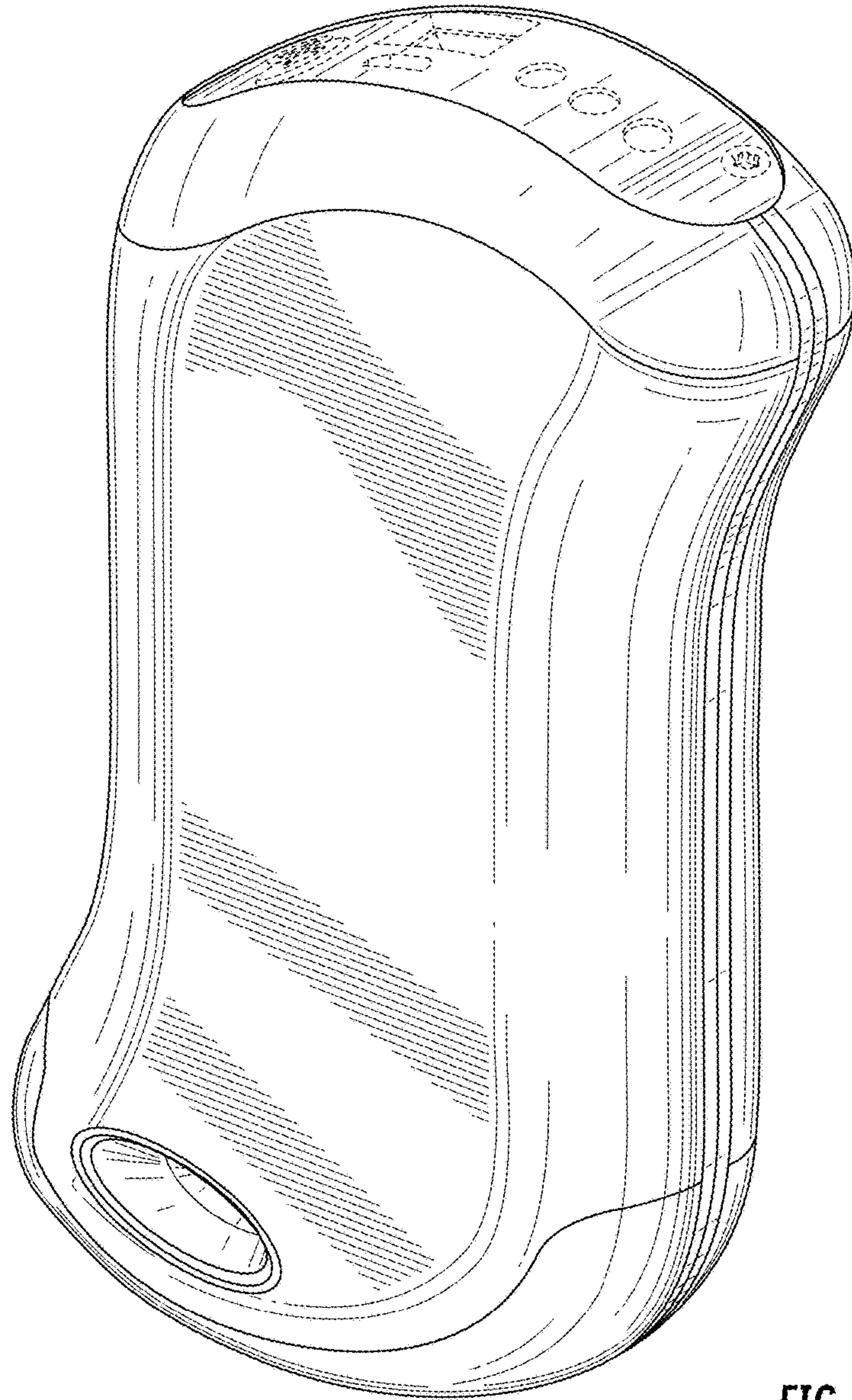

FIG. 1

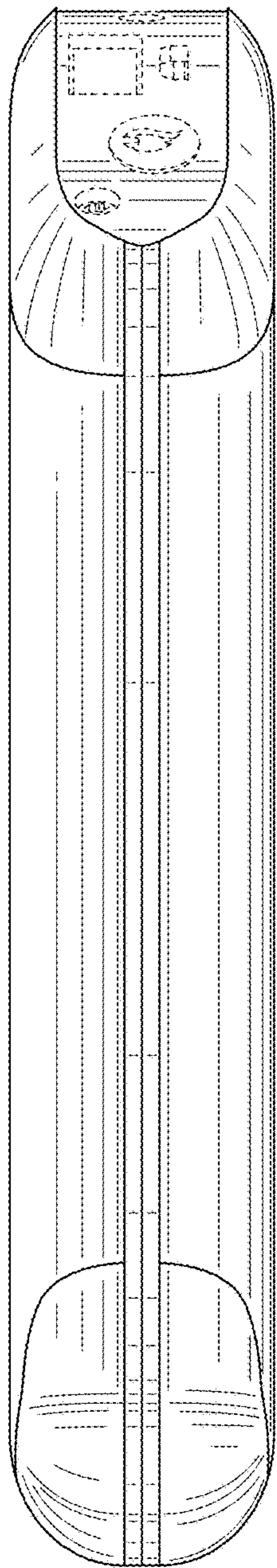

FIG. 2

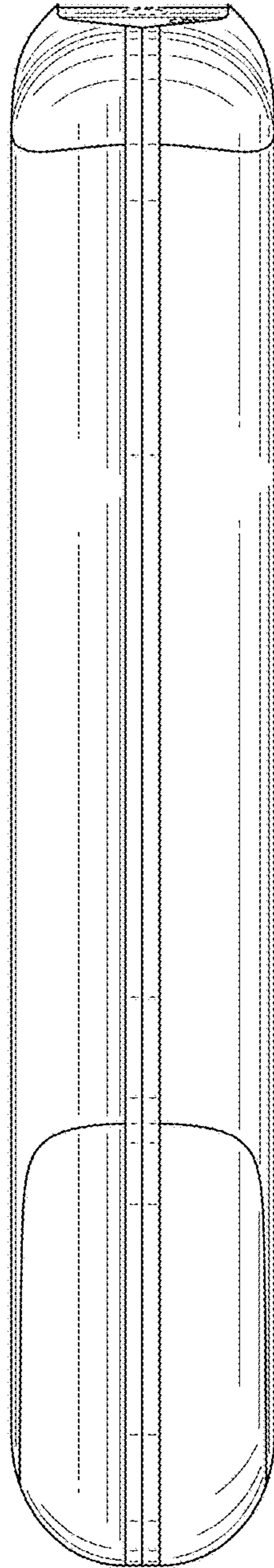

FIG. 3

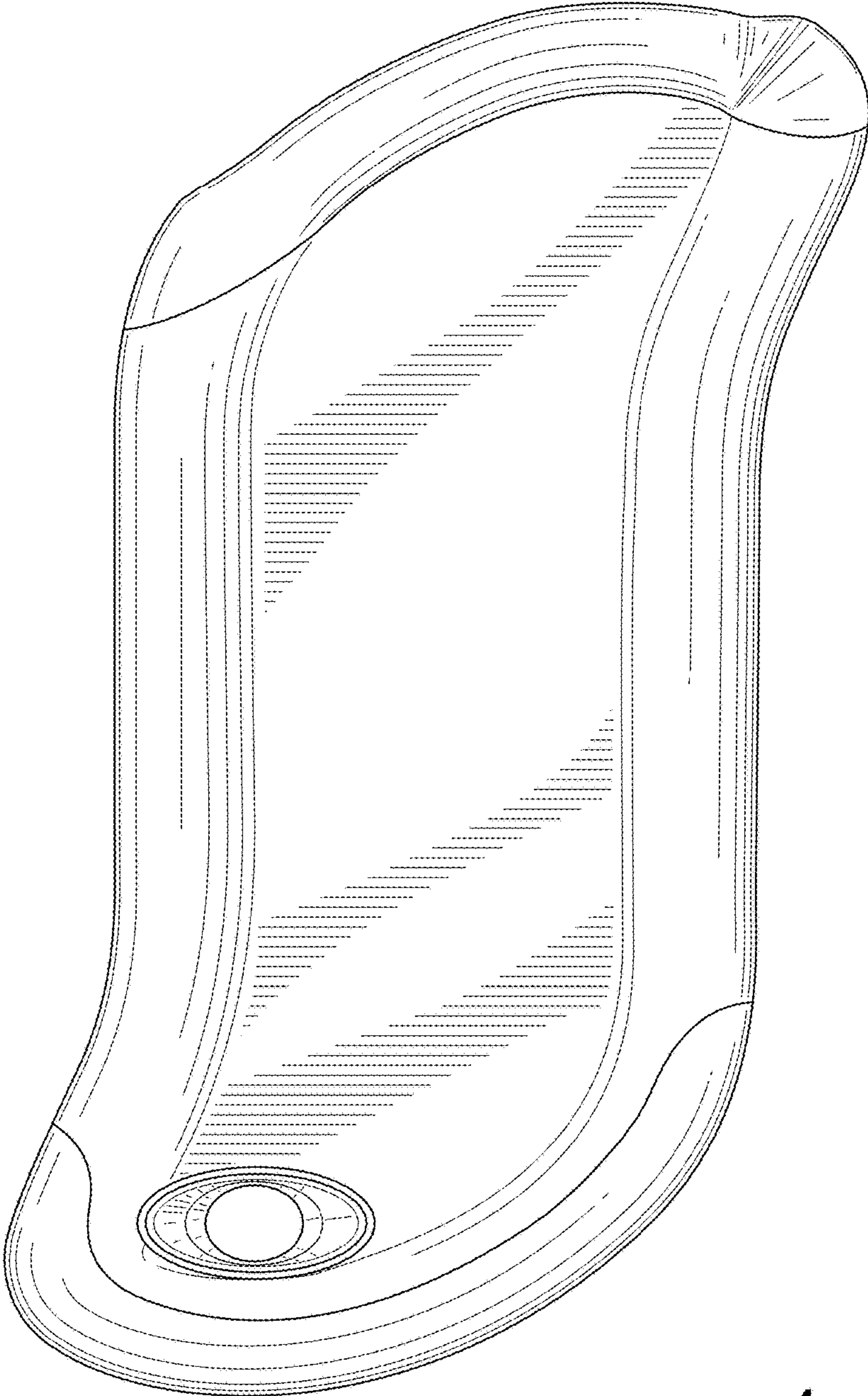

FIG. 4

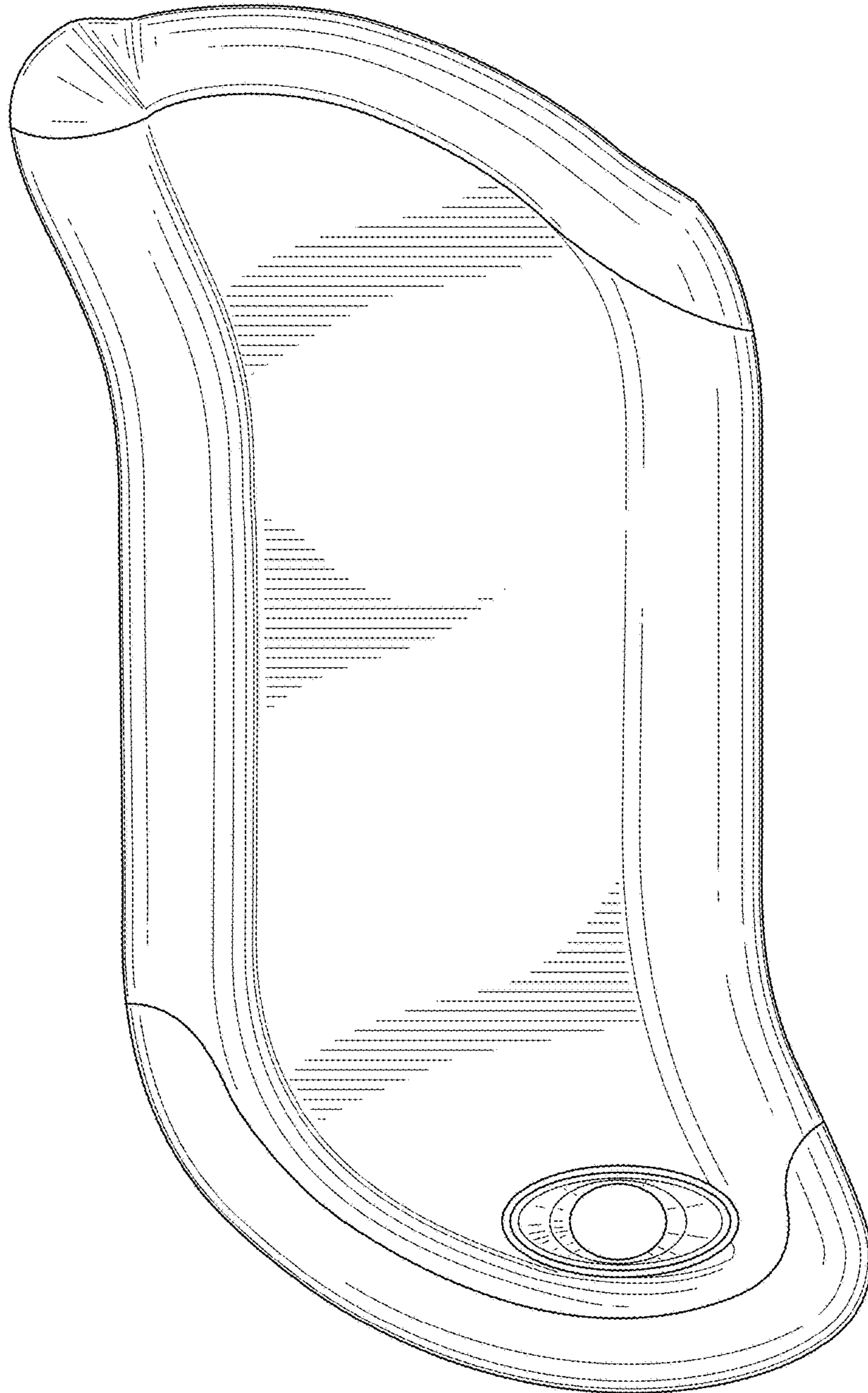

FIG. 5

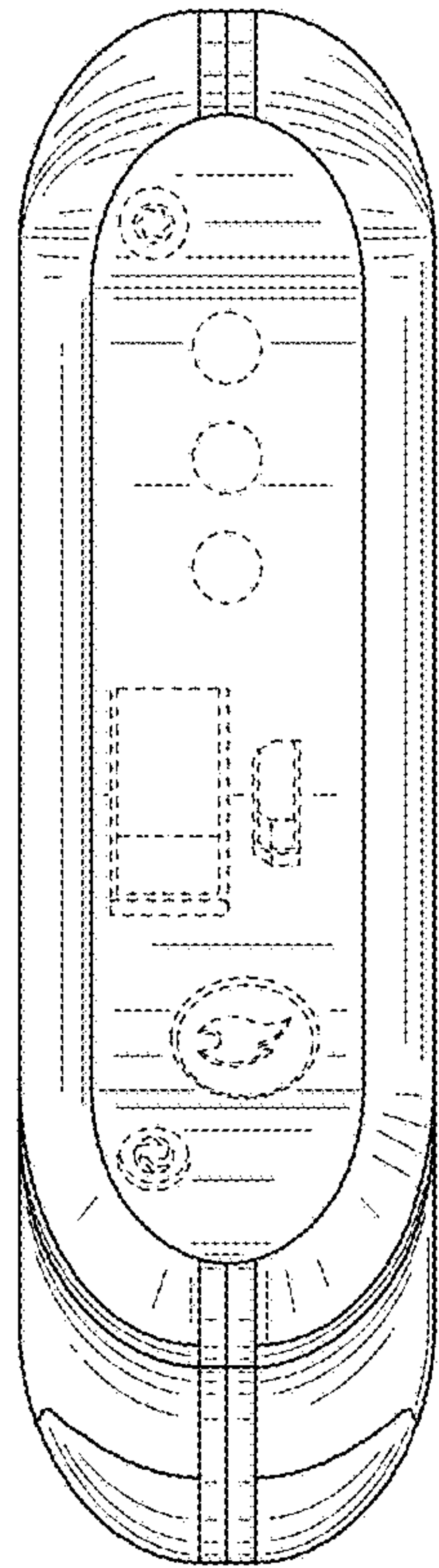

FIG. 6

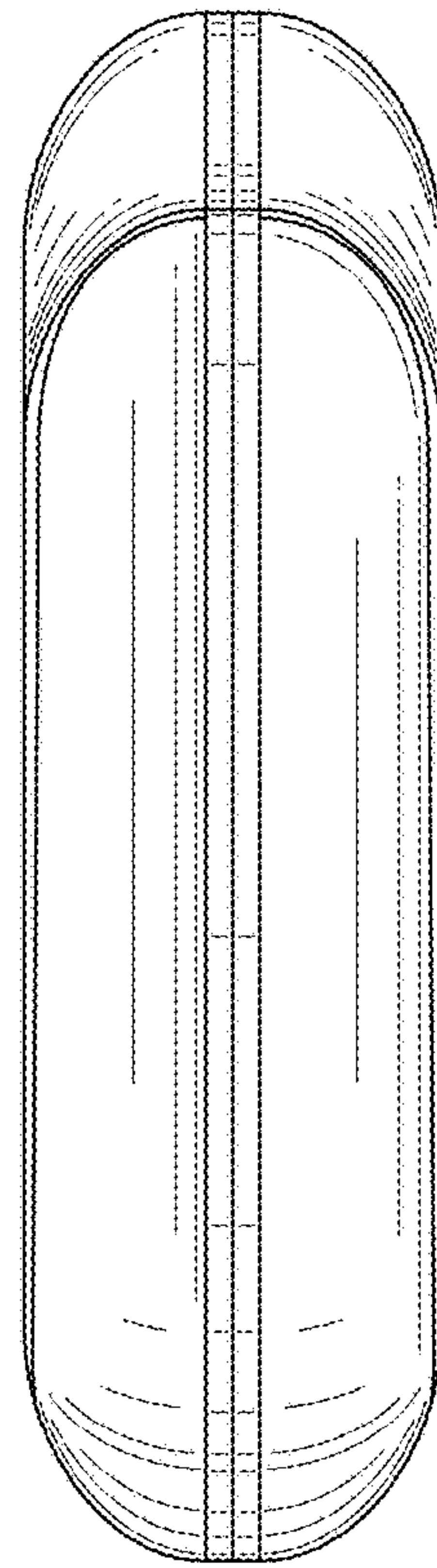

FIG. 7

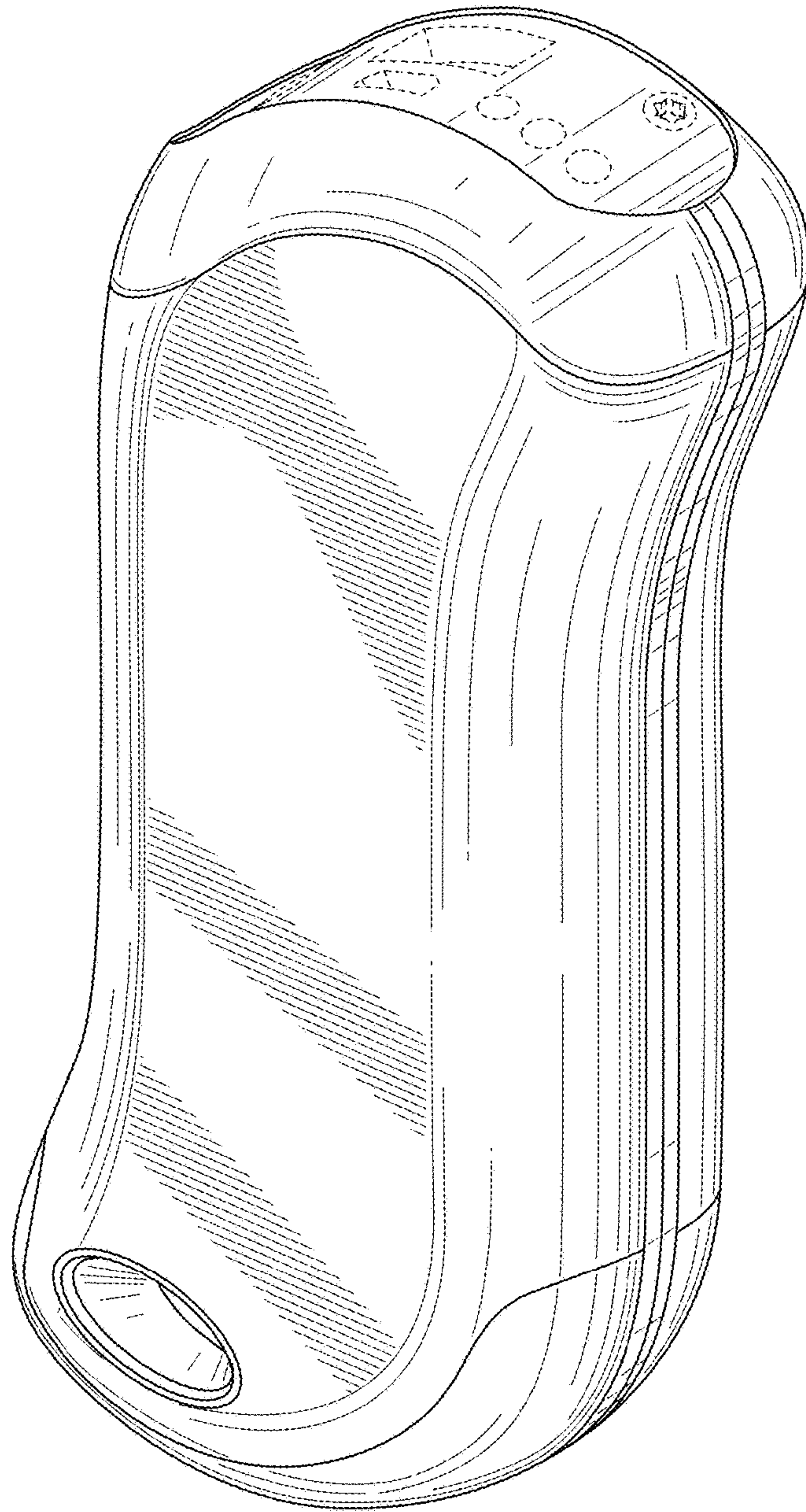

FIG. 8

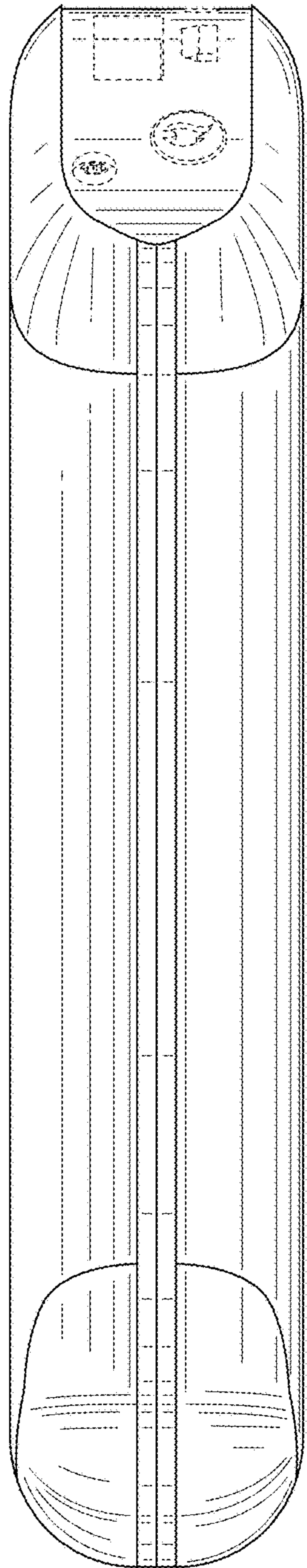

FIG. 9

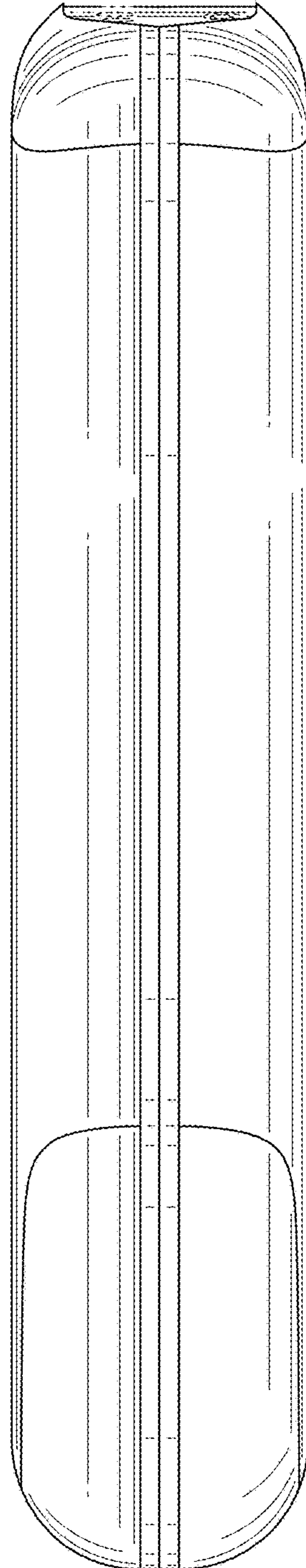

FIG. 10

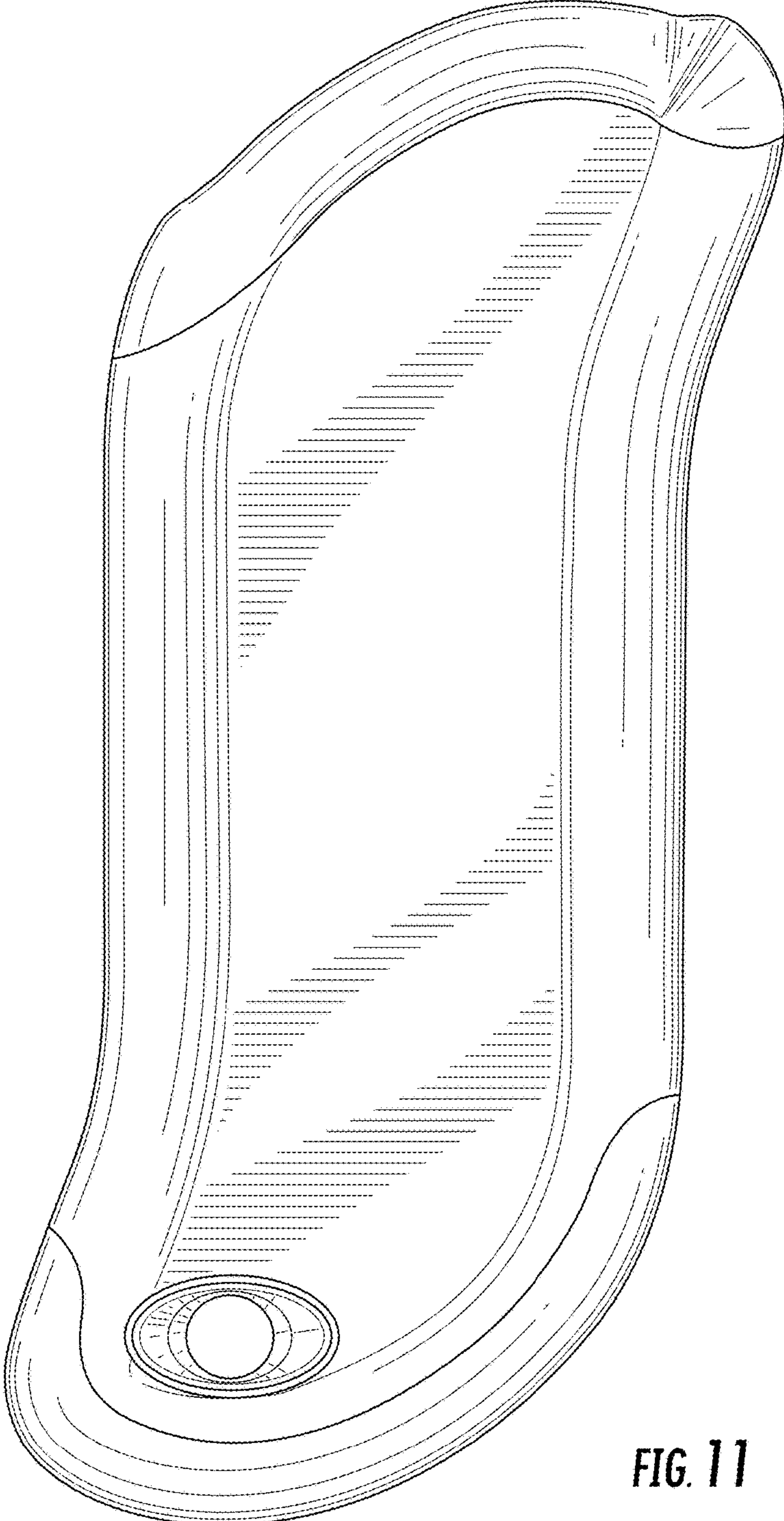

FIG. 11

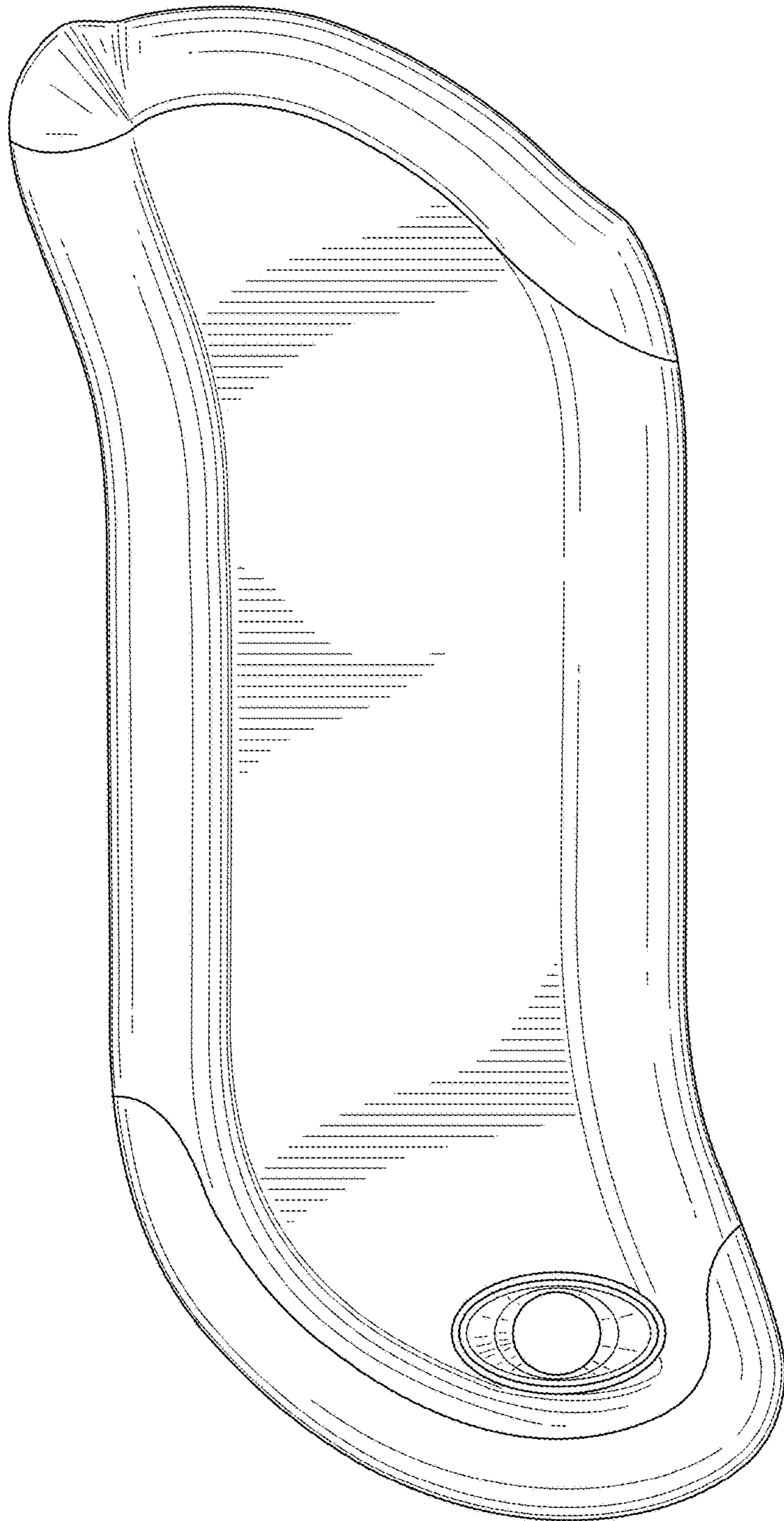

FIG. 12

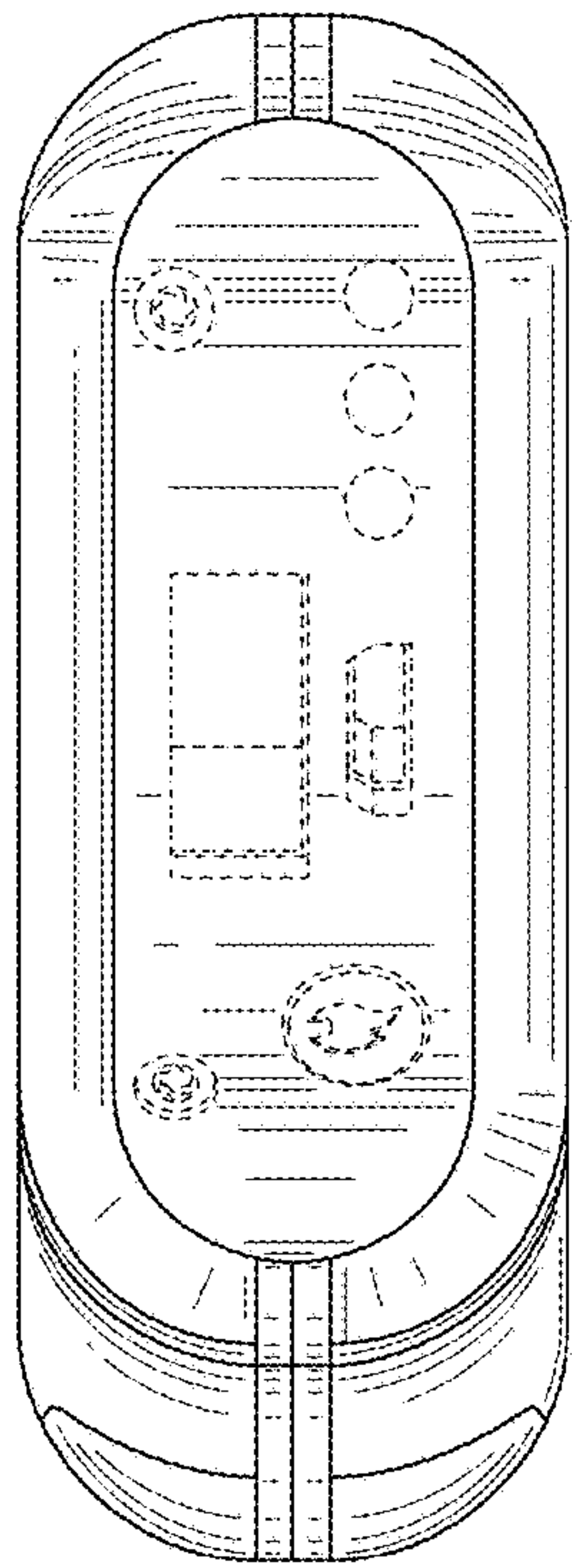

FIG. 13

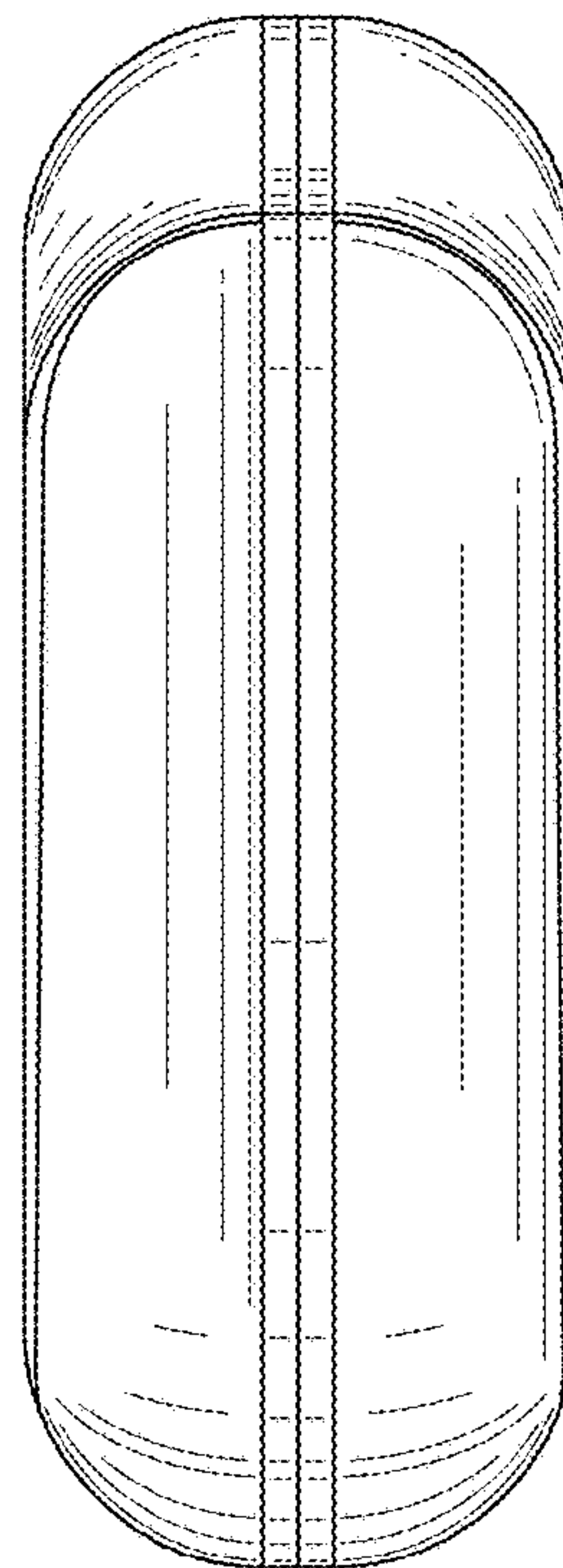

FIG. 14