



US00D858775S

(12) **United States Design Patent** (10) **Patent No.:** **US D858,775 S**  
**Wightman et al.** (45) **Date of Patent:** **\*\* Sep. 3, 2019**

(54) **BLOOD TESTING APPARATUS**

(56) **References Cited**

- (71) Applicant: **Roche Diagnostics Operations, Inc.**,  
Indianapolis, IN (US)
- (72) Inventors: **Craig Ian Wightman**, Bristol (GB);  
**Johann Florian Wassermann**, Horgen  
(CH); **Michael John Unwin**,  
Bishopston Bristol (GB)
- (73) Assignee: **Roche Diagnostics Operations, Inc.**,  
Indianapolis, IN (US)
- (\*\*) Term: **15 Years**
- (21) Appl. No.: **29/647,953**
- (22) Filed: **May 17, 2018**

U.S. PATENT DOCUMENTS

5,281,395 A	1/1994	Markart et al.
D406,895 S	3/1999	Byrd et al.
D493,536 S	7/2004	Jaeck et al.
D545,436 S	6/2007	Padain
D627,068 S	11/2010	Brauer et al.
D648,029 S	11/2011	Presta et al.
8,427,817 B2	4/2013	Lewis et al.
8,515,775 B2	8/2013	Galley et al.
D690,422 S	9/2013	Oka
D696,404 S	12/2013	Golnik et al.
D721,177 S	1/2015	Ahlstrom et al.
D721,178 S	1/2015	Harkin et al.
D723,695 S	3/2015	Chung
D724,223 S	3/2015	Nishiyama et al.

(Continued)

*Primary Examiner* — Anhdao Doan

(74) *Attorney, Agent, or Firm* — Dinsmore & Shohl, LLP

**Related U.S. Application Data**

- (60) Continuation of application No. 29/607,658, filed on Jun. 15, 2017, now Pat. No. Des. 820,989, which is a continuation of application No. 29/583,390, filed on Nov. 4, 2016, now Pat. No. Des. 804,033, which is a division of application No. 29/512,655, filed on Dec. 22, 2014, now Pat. No. Des. 787,067.

(57) **CLAIM**

The ornamental design for a blood testing apparatus, as shown and described.

**DESCRIPTION**

(30) **Foreign Application Priority Data**

Jun. 27, 2014 (EP) ..... 002492397-0001  
 Jun. 27, 2014 (EP) ..... 002492397-0002

(51) **LOC (12) Cl.** ..... **24-01**

(52) **U.S. Cl.**  
 USPC ..... **D24/169**

(58) **Field of Classification Search**  
 USPC ..... D24/164–169, 186, 107, 216; D10/81  
 CPC ..... A61B 5/14532; A61B 5/14865; A61B  
 2560/0412; A61B 2560/0443; A61B  
 2560/0462; A61M 25/0606; A61M  
 25/0631

See application file for complete search history.

FIG. 1 is a right side, front perspective view of a blood testing apparatus illustrating our new design;  
 FIG. 2 is a left side, rear perspective view of FIG. 1 thereof;  
 FIG. 3 is a front view of FIG. 1 thereof;  
 FIG. 4 is a rear view of FIG. 1 thereof;  
 FIG. 5 is a bottom plan view of FIG. 1 thereof;  
 FIG. 6 is a top plan view of FIG. 1 thereof; and,  
 FIG. 7 is a left side view of FIG. 1 thereof, the right side being the same.

The broken lines in the drawing views illustrate portions of the blood testing apparatus that form no part of the claimed design.

**1 Claim, 7 Drawing Sheets**

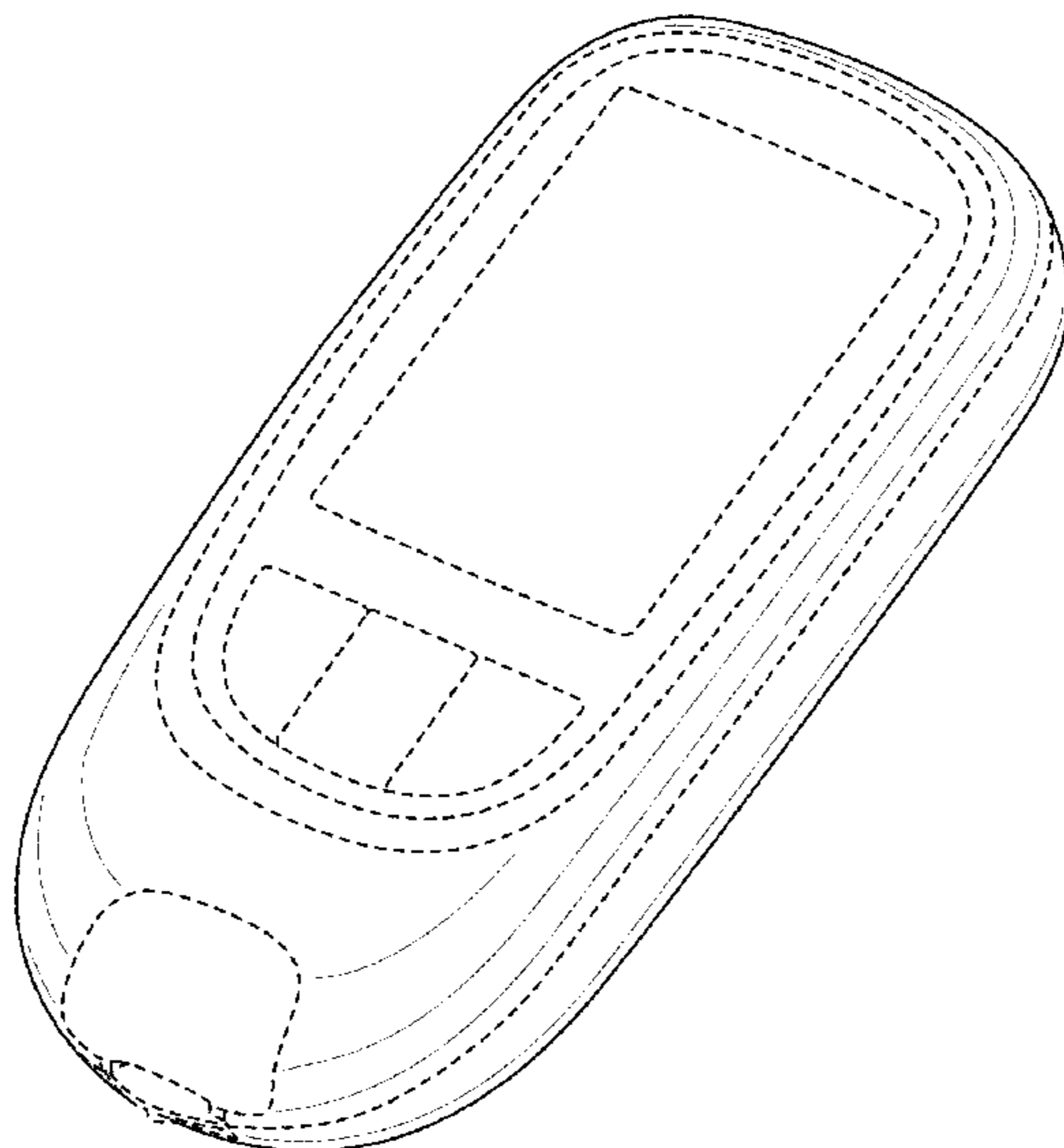

(56)

**References Cited**

U.S. PATENT DOCUMENTS

9,022,931	B2	5/2015	Brauer et al.	
D734,468	S	7/2015	Murakami et al.	
D737,980	S	* 9/2015	Golnik .....	D24/169
D739,945	S	9/2015	Cadio et al.	
D747,490	S	1/2016	Harkin et al.	
D766,442	S	9/2016	Prais et al.	
D778,445	S	* 2/2017	Cadio .....	D24/169
D787,067	S	5/2017	Wightmann et al.	
D794,803	S	8/2017	Thom	
D804,033	S	11/2017	Wightmann et al.	
D820,989	S	* 6/2018	Wightman .....	D24/169
2012/0095316	A1	4/2012	Lewis et al.	
2012/0095318	A1	4/2012	Galley et al.	
2012/0095691	A1	4/2012	Galley et al.	
2012/0165640	A1	6/2012	Galley et al.	
2012/0266251	A1	10/2012	Birtwhistle et al.	

\* cited by examiner

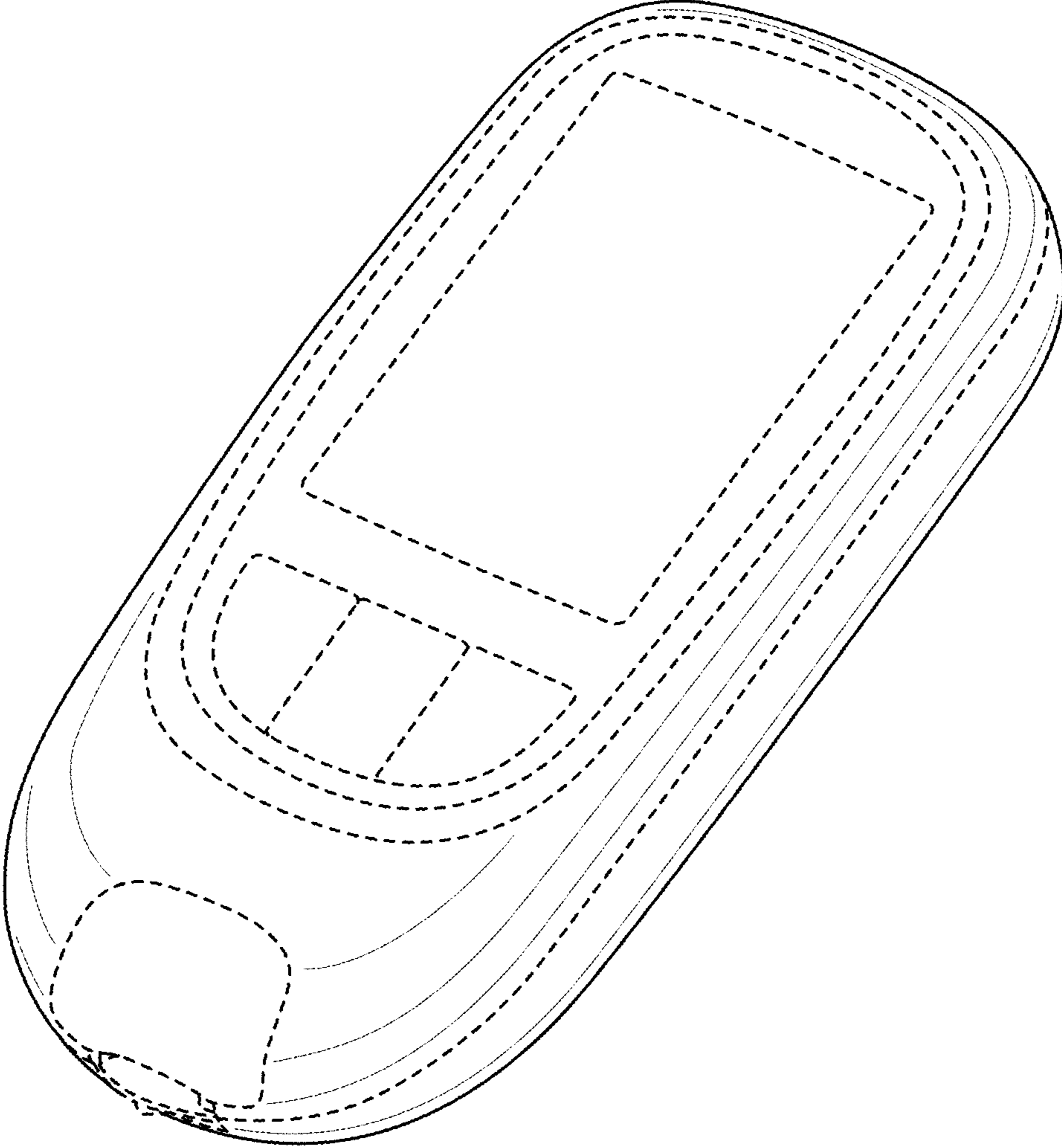

FIG. 1

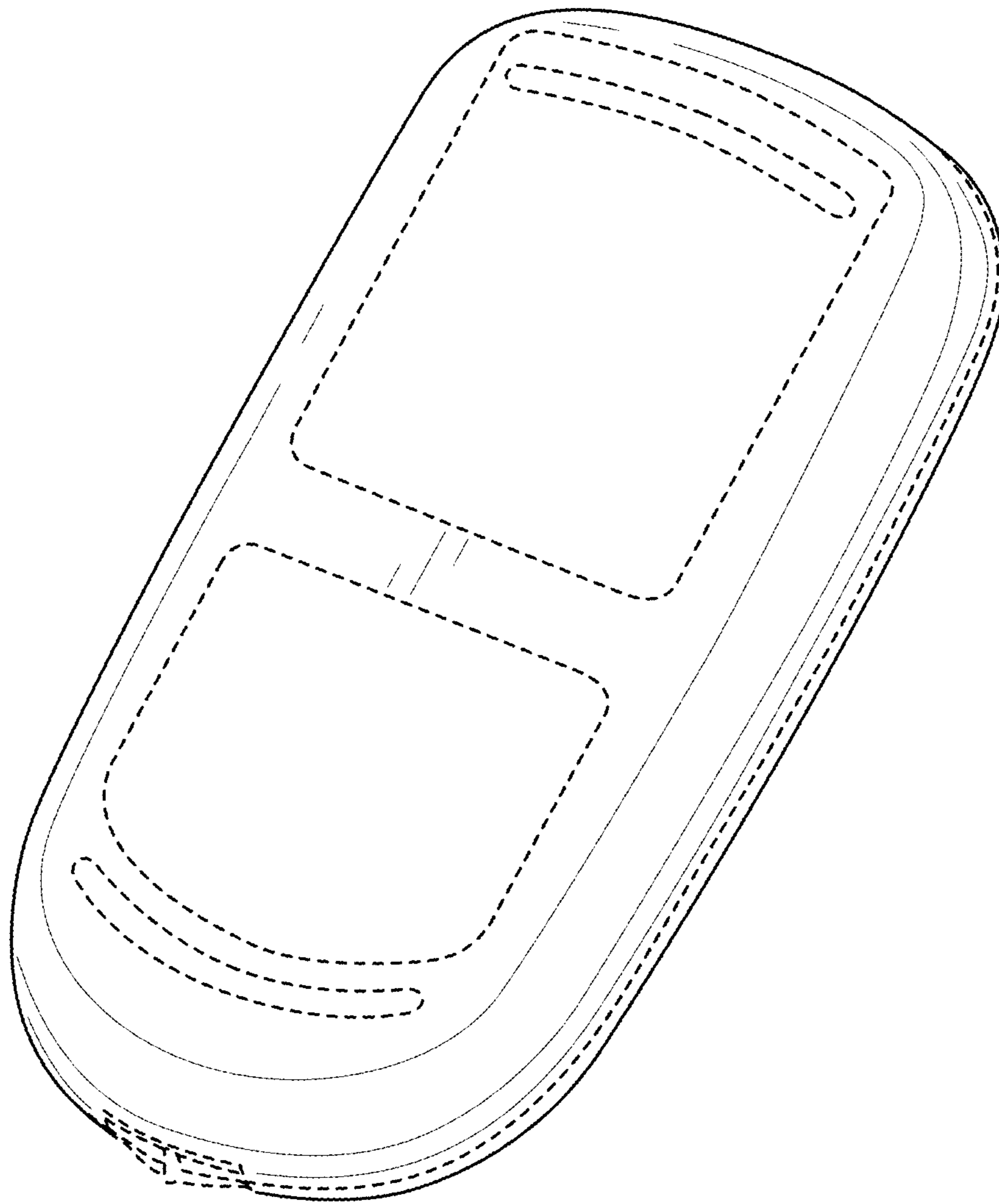

FIG. 2

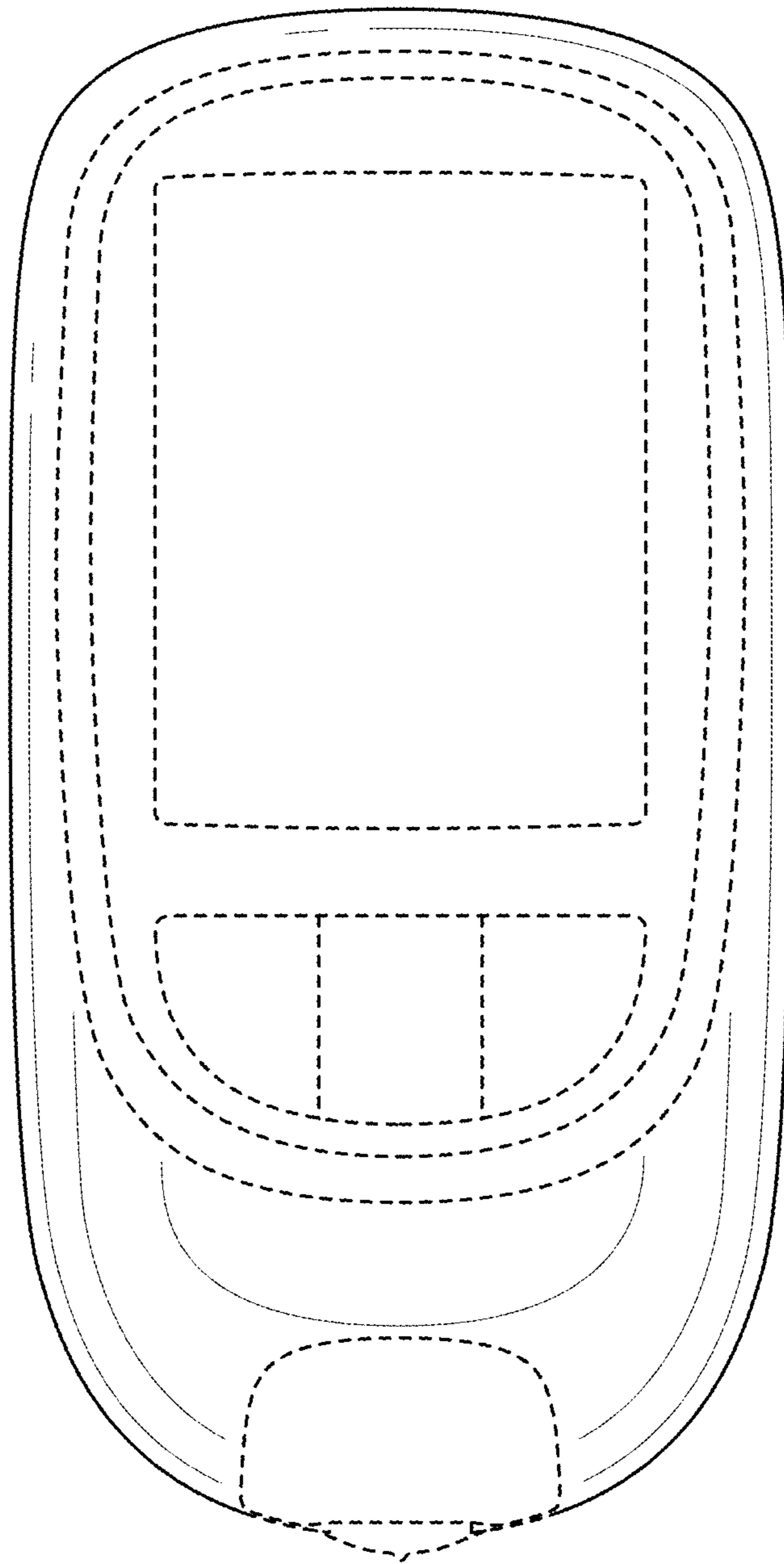

FIG. 3

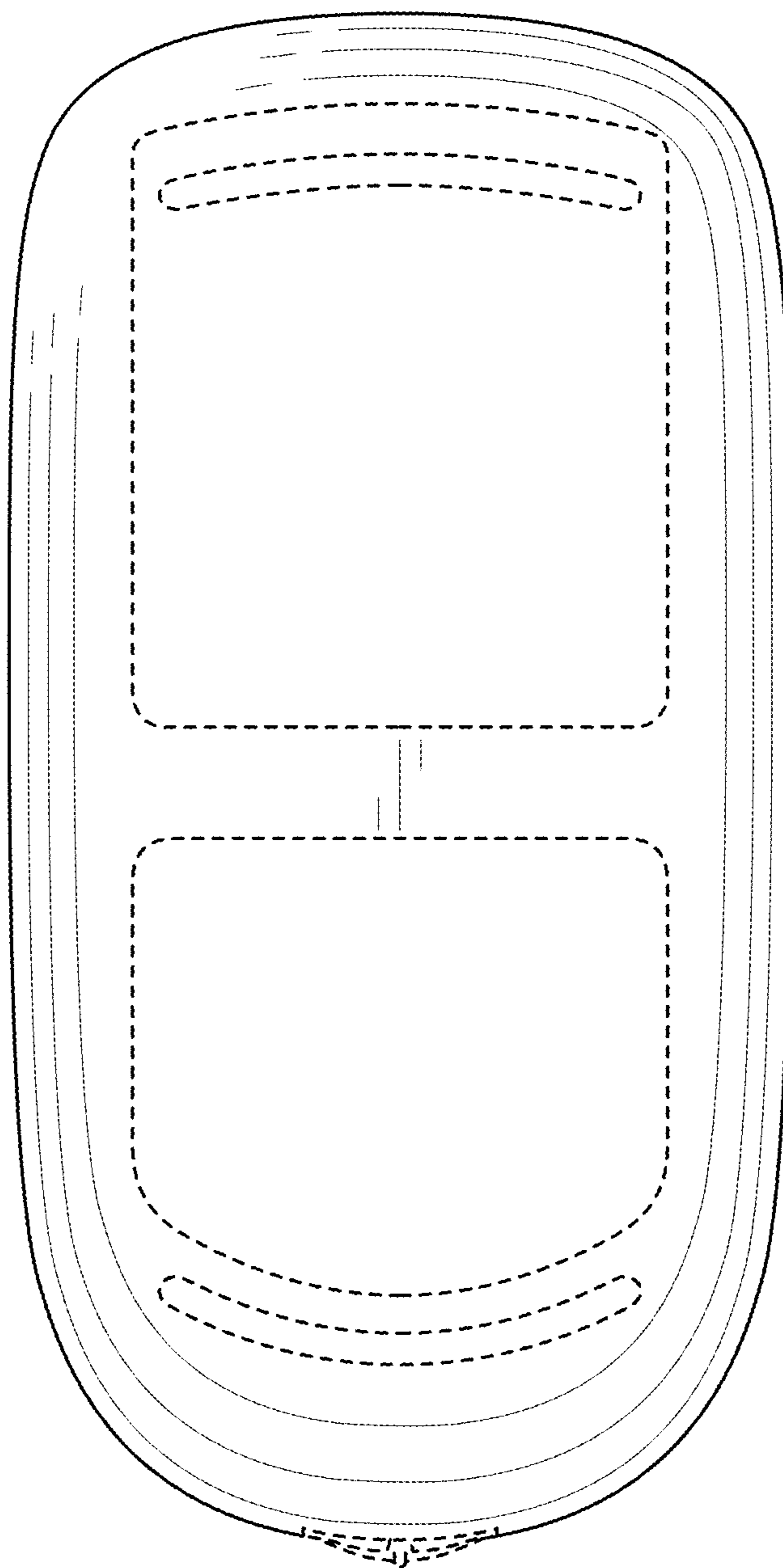

FIG. 4

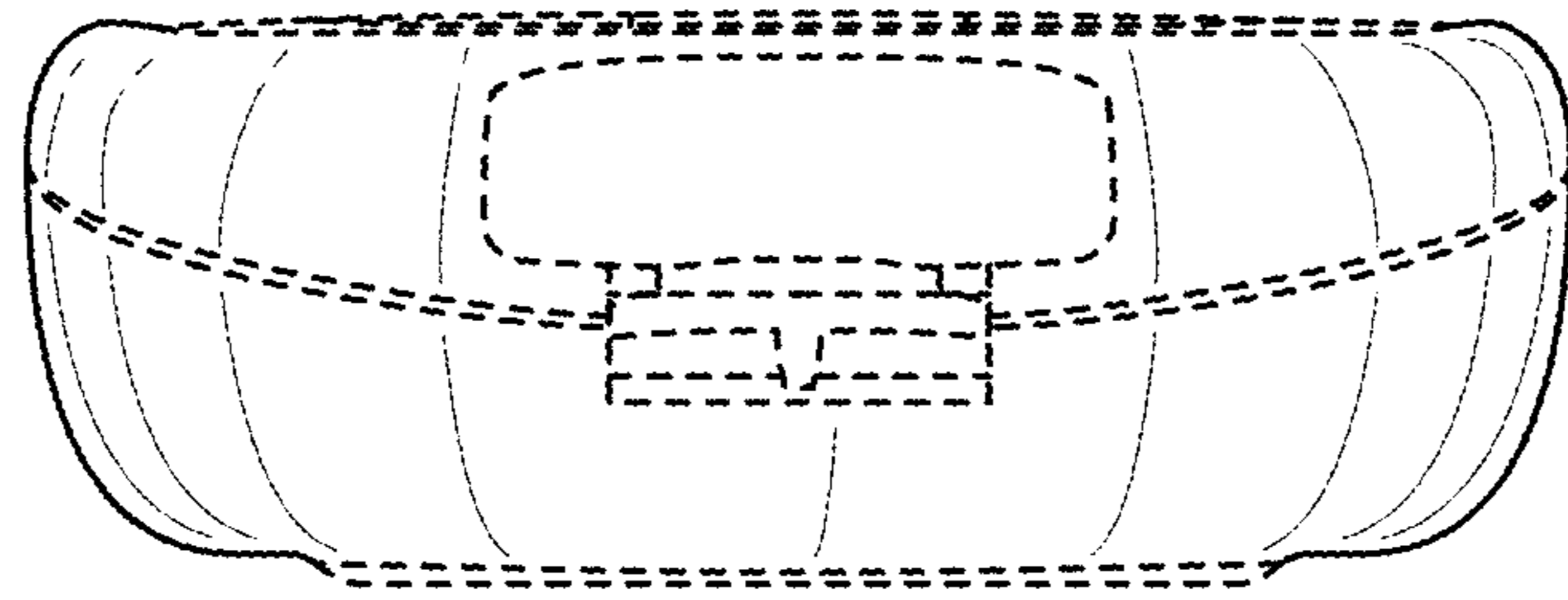

FIG. 5

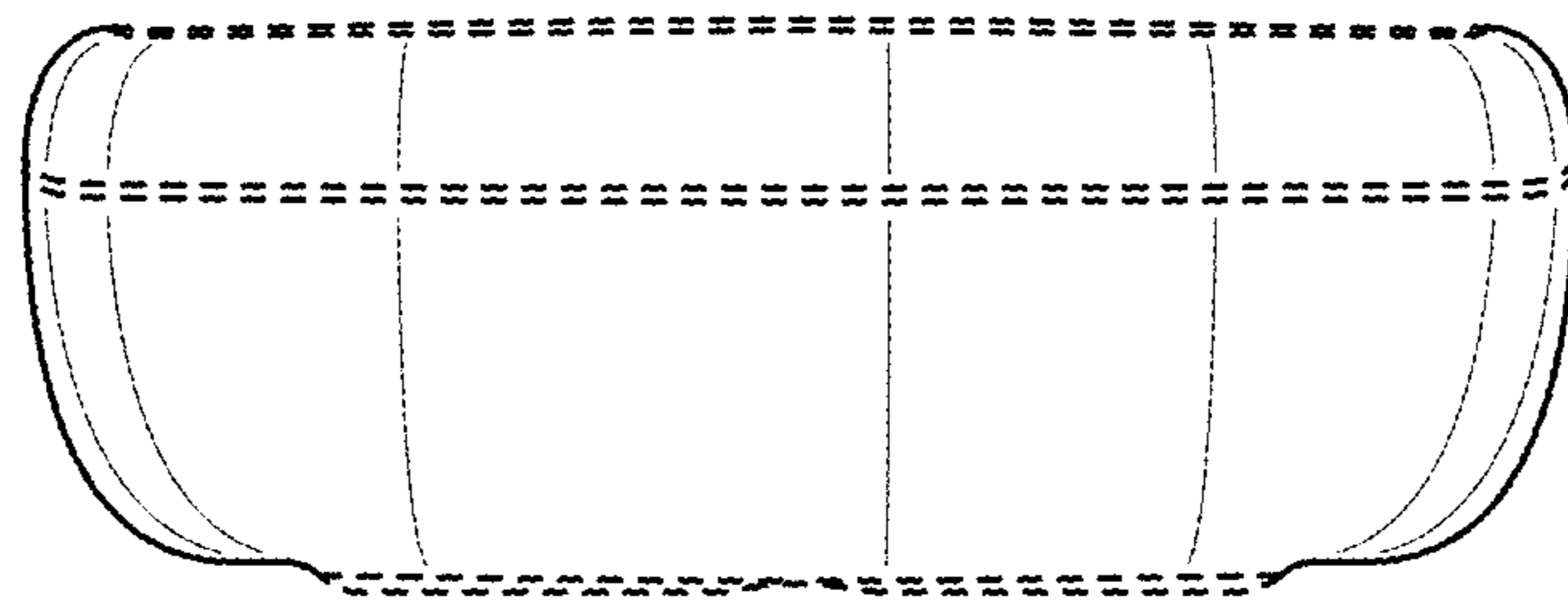

FIG. 6



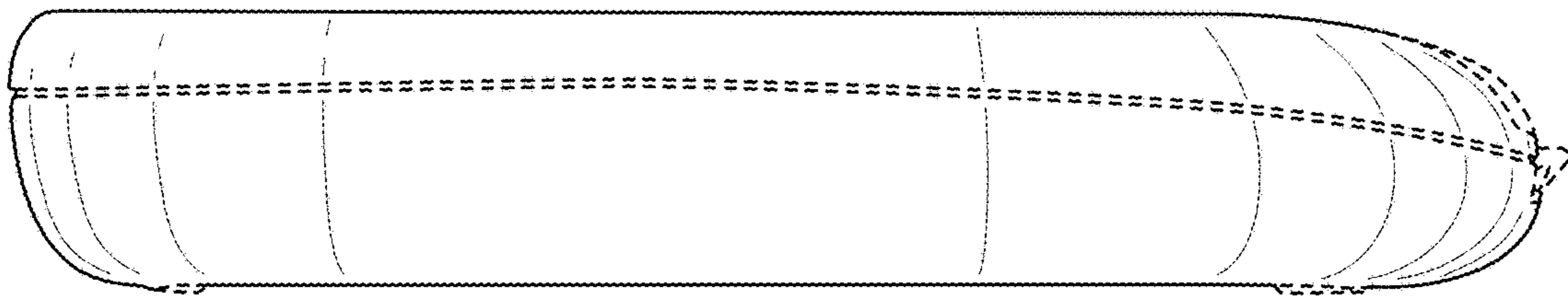

FIG. 7