



US00D858768S

(12) **United States Design Patent** (10) **Patent No.:** **US D858,768 S**
Casas-Ganem et al. (45) **Date of Patent:** **** Sep. 3, 2019**

(54) **ACETABULAR DEVICE**

(71) Applicant: **Surgical Device Innovations, LLC**,
Dallas, TX (US)
(72) Inventors: **Jorge Casas-Ganem**, Dallas, TX (US);
Joshua Haney, Frisco, TX (US)
(73) Assignee: **Surgical Device Innovations, LLC**,
Dallas, TX (US)

(**) Term: **15 Years**

(21) Appl. No.: **29/575,649**

(22) Filed: **Aug. 26, 2016**

(51) **LOC (12) Cl.** **24-03**

(52) **U.S. Cl.**
USPC **D24/155**

(58) **Field of Classification Search**
USPC D24/155-157
CPC A61F 2/36; A61F 2/3662; A61F 2/30767;
A61F 2/34; A61F 2002/3631; A61F
2002/30332; A61F 2002/365; A61F
2002/30507; A61F 2310/00029
See application file for complete search history.

(56) **References Cited**

U.S. PATENT DOCUMENTS

3,528,109	A	9/1970	Scales	
3,685,058	A	8/1972	Tronzo	
3,808,606	A	5/1974	Tronzo	
3,840,904	A	10/1974	Tronzo	
4,769,041	A	9/1988	Morscher	
4,828,565	A	5/1989	Duthoit	
4,936,856	A	6/1990	Keller	
5,049,158	A *	9/1991	Engelhardt A61F 2/34 403/326
5,108,446	A	4/1992	Wagner	
5,171,285	A *	12/1992	Broderick A61F 2/34 623/22.25
5,211,665	A	5/1993	Ku	

(Continued)

OTHER PUBLICATIONS

Stanmore Implants; METS Coned Hemi-Pelvis; brochure; Copy-
right 2010.

(Continued)

Primary Examiner — Charles D Hanson

(74) *Attorney, Agent, or Firm* — Polsinelli PC; Adam C.
Rehm

(57) **CLAIM**

The ornamental design for an acetabular device, as shown
and described.

DESCRIPTION

FIG. 1 is a top, left, rear perspective view of an acetabular
device according to an embodiment of the new design;
FIG. 2 is a front side elevation view thereof;
FIG. 3 is a rear side elevation view thereof;
FIG. 4 is a left side elevation view thereof;
FIG. 5 is a right side elevation view thereof;
FIG. 6 is a top plan view thereof;
FIG. 7 is a bottom plan view thereof;
FIG. 8 is a bottom, left, rear perspective view thereof;
FIG. 9 is a top, left, rear perspective view of an acetabular
device according to another embodiment of the new design;
FIG. 10 is a front side elevation view thereof;
FIG. 11 is a rear side elevation view thereof;
FIG. 12 is a left side elevation view thereof;
FIG. 13 is a right side elevation view thereof;
FIG. 14 is a top plan view thereof;
FIG. 15 is a bottom plan view thereof; and,
FIG. 16 is a bottom, left, rear perspective view thereof.
The broken line showing is included for the purpose of
illustrating unclaimed subject matter and forms no part of
the claimed design.

1 Claim, 16 Drawing Sheets

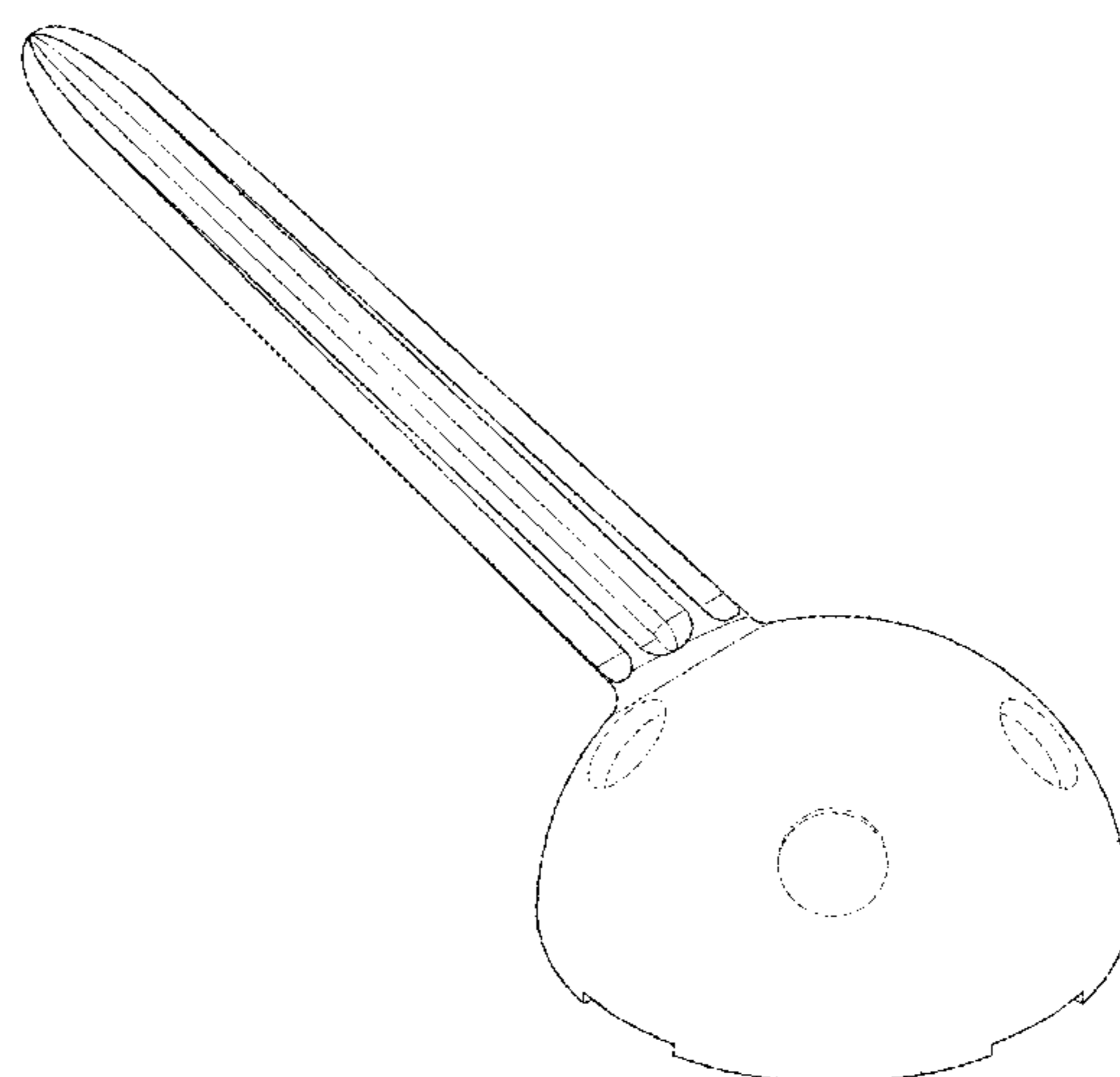
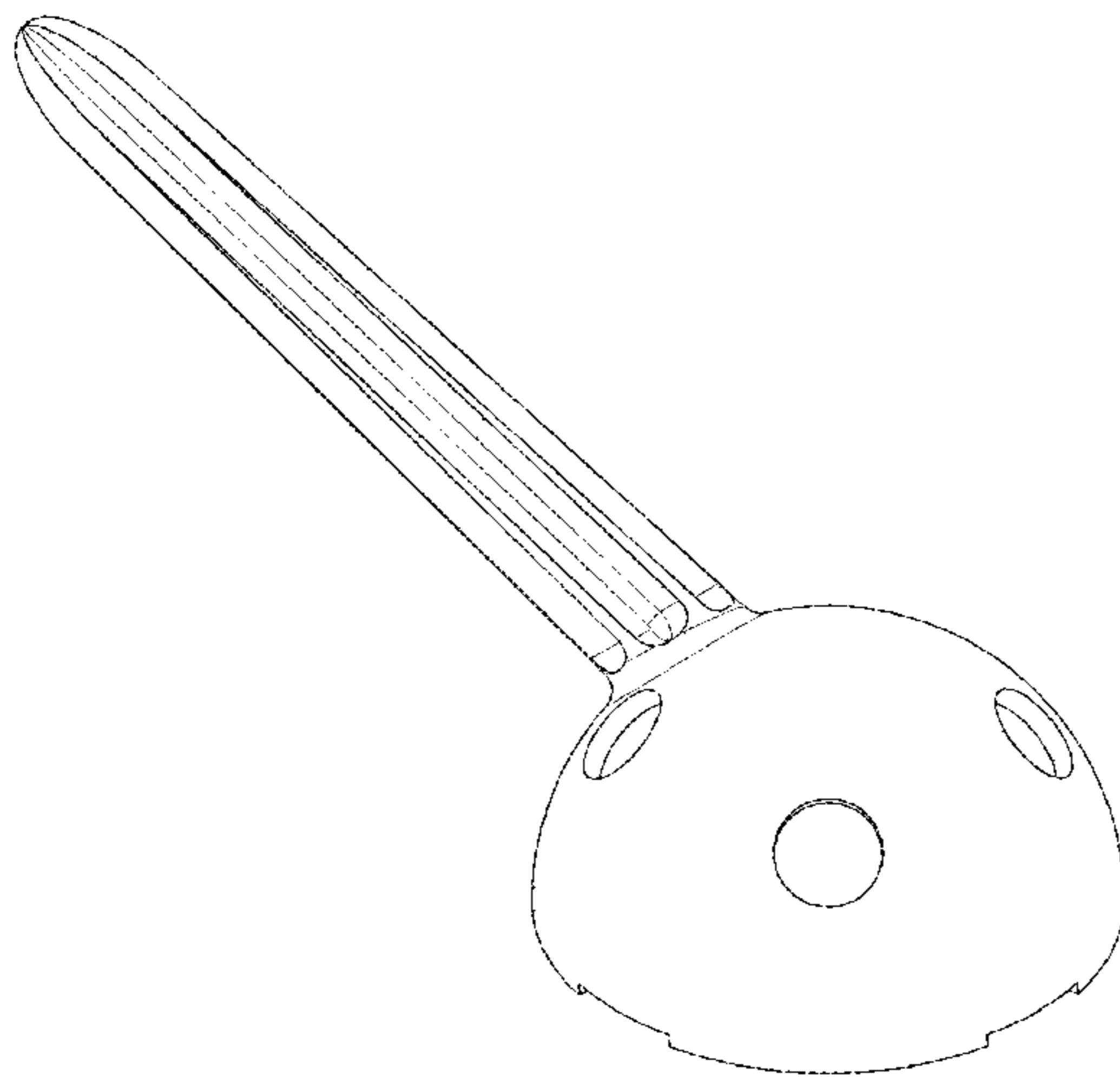

(56)

References Cited

U.S. PATENT DOCUMENTS

5,549,691 A 8/1996 Harwin
 5,653,765 A 8/1997 McTighe
 5,658,347 A * 8/1997 Sarkisian A61B 17/1666
 623/22.22
 5,725,594 A 3/1998 McTighe
 5,904,688 A * 5/1999 Gilbert A61F 2/4609
 606/81
 5,938,702 A * 8/1999 Lopez A61F 2/468
 623/22.24
 6,332,896 B1 12/2001 Hubbard
 7,255,712 B1 8/2007 Steinberg
 7,267,693 B1 * 9/2007 Mandell A61F 2/30721
 623/22.28
 7,597,715 B2 10/2009 Brown
 D618,800 S * 6/2010 Mayon D24/155
 8,308,811 B2 * 11/2012 Newsome A61F 2/30721
 623/22.21
 8,372,155 B2 * 2/2013 Tuke A61F 2/34
 623/22.21
 8,641,771 B2 * 2/2014 Caylor, III A61B 5/4528
 623/22.28

8,900,321 B2 12/2014 Weiss
 9,144,497 B2 * 9/2015 Sun A61F 2/34
 9,180,013 B2 * 11/2015 Grostefon A61F 2/34
 9,220,599 B2 * 12/2015 Meridew A61F 2/34
 9,248,023 B2 2/2016 Ries
 9,308,102 B2 * 4/2016 McCarthy A61F 2/4684
 D765,845 S * 9/2016 Prybyla D24/155
 9,820,853 B2 * 11/2017 Meridew A61F 2/32
 9,820,854 B2 * 11/2017 Preuss A61F 2/34
 9,931,213 B2 * 4/2018 Sartawi A61F 2/34
 9,987,148 B2 * 6/2018 Li A61F 2/4609
 2005/0234559 A1 10/2005 Fernandez
 2013/0131823 A1 5/2013 Morrey
 2017/0202671 A1 7/2017 Ries

OTHER PUBLICATIONS

Fiorenza, Fabrice; Indications and treatments for partial pelvic defects: pedestal cups; Arthroplasty Disaster Conference; PowerPoint presentation dated Sep. 21-23, 2016.
 Implantcast GMBH; Mutars LUMiC Surgical Technique; brochure dated Jun. 2016.

* cited by examiner

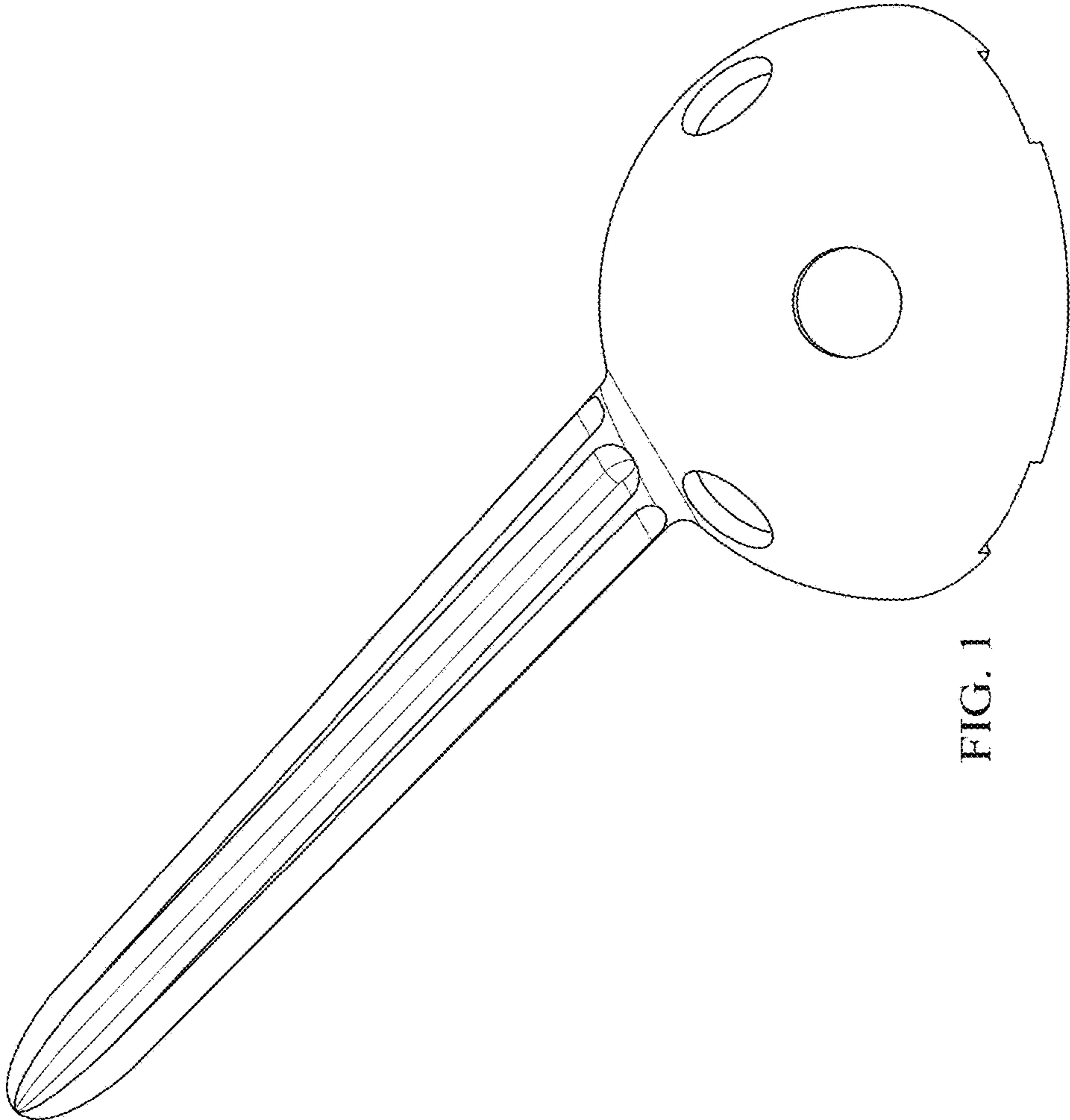

FIG. 1

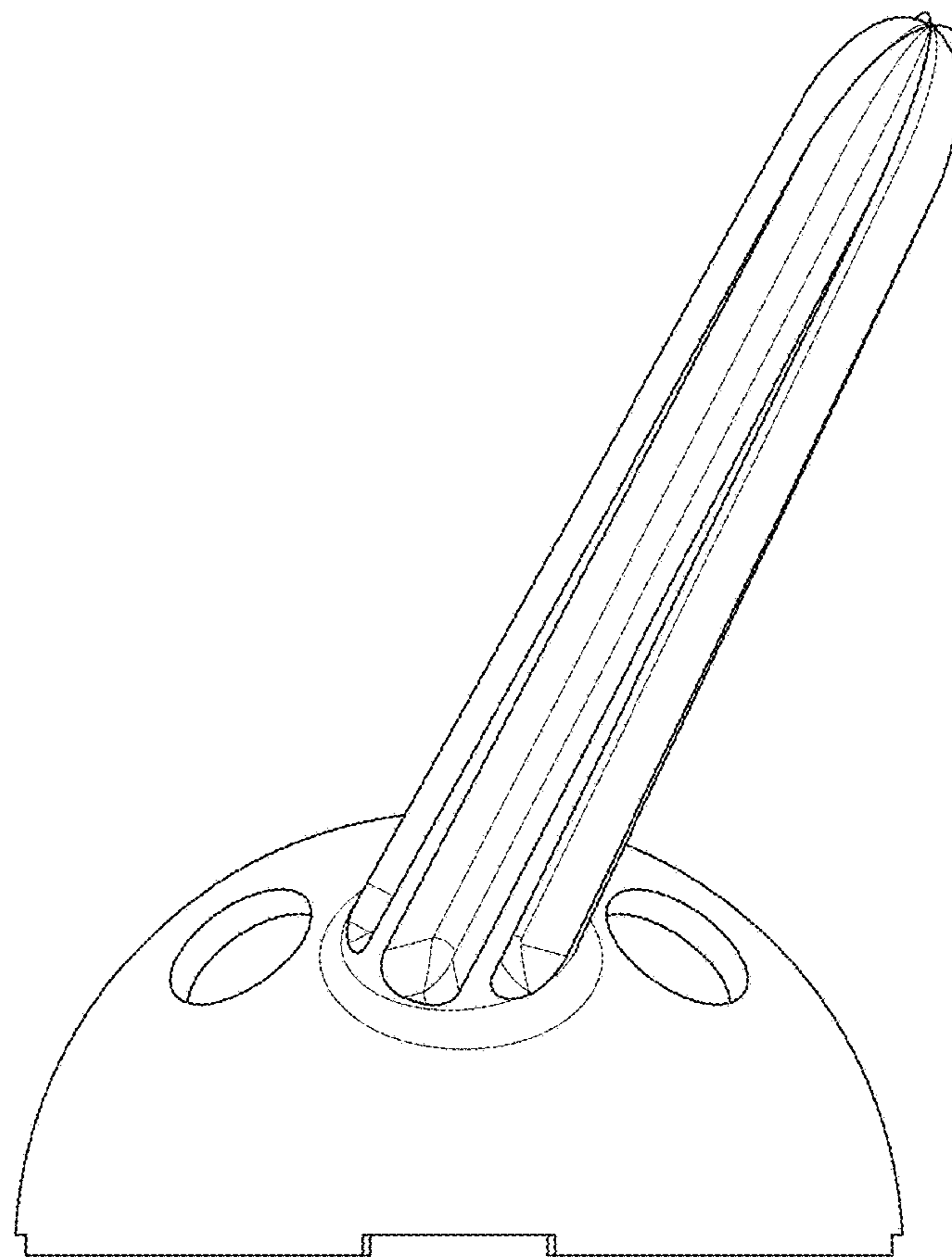

FIG. 2

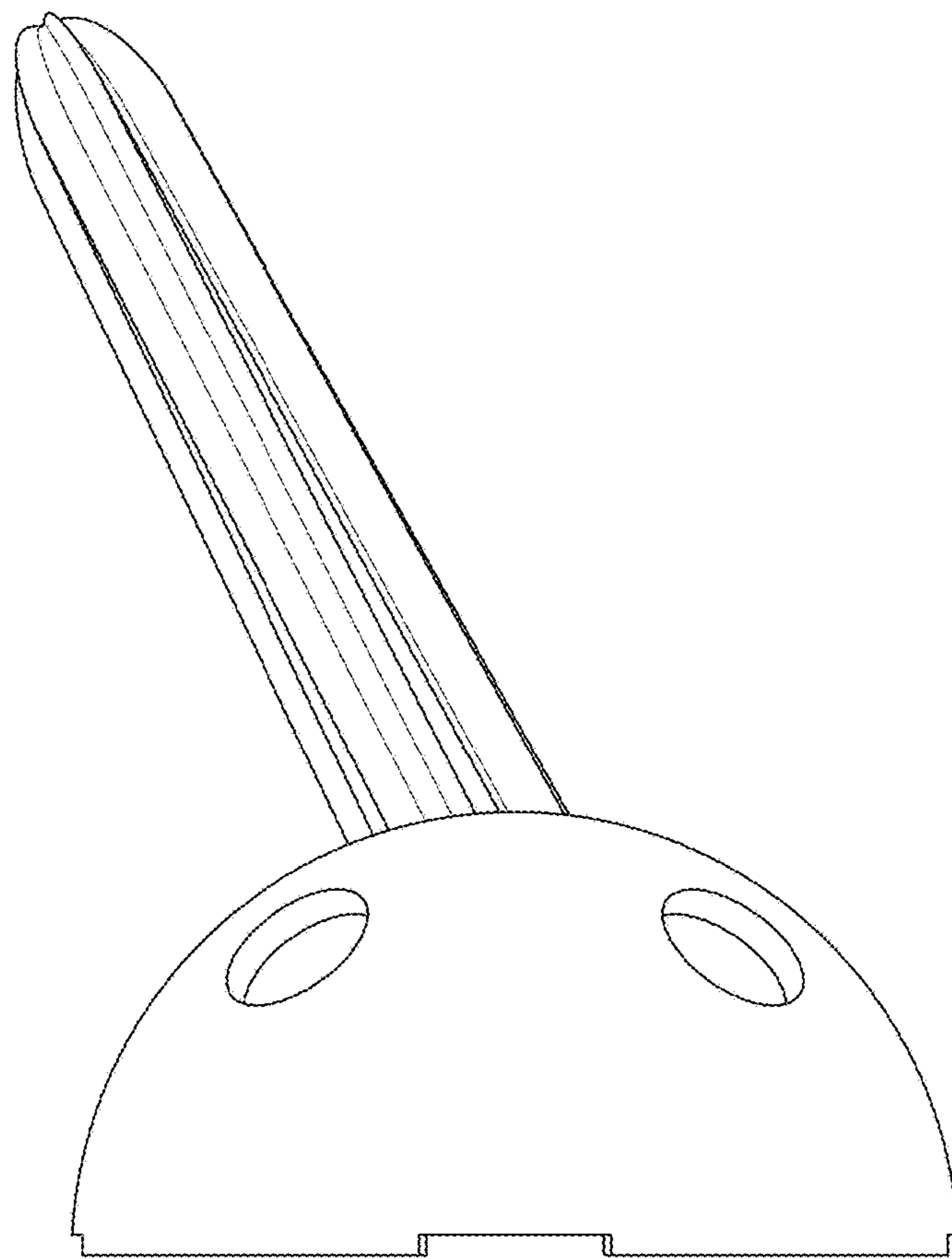

FIG. 3

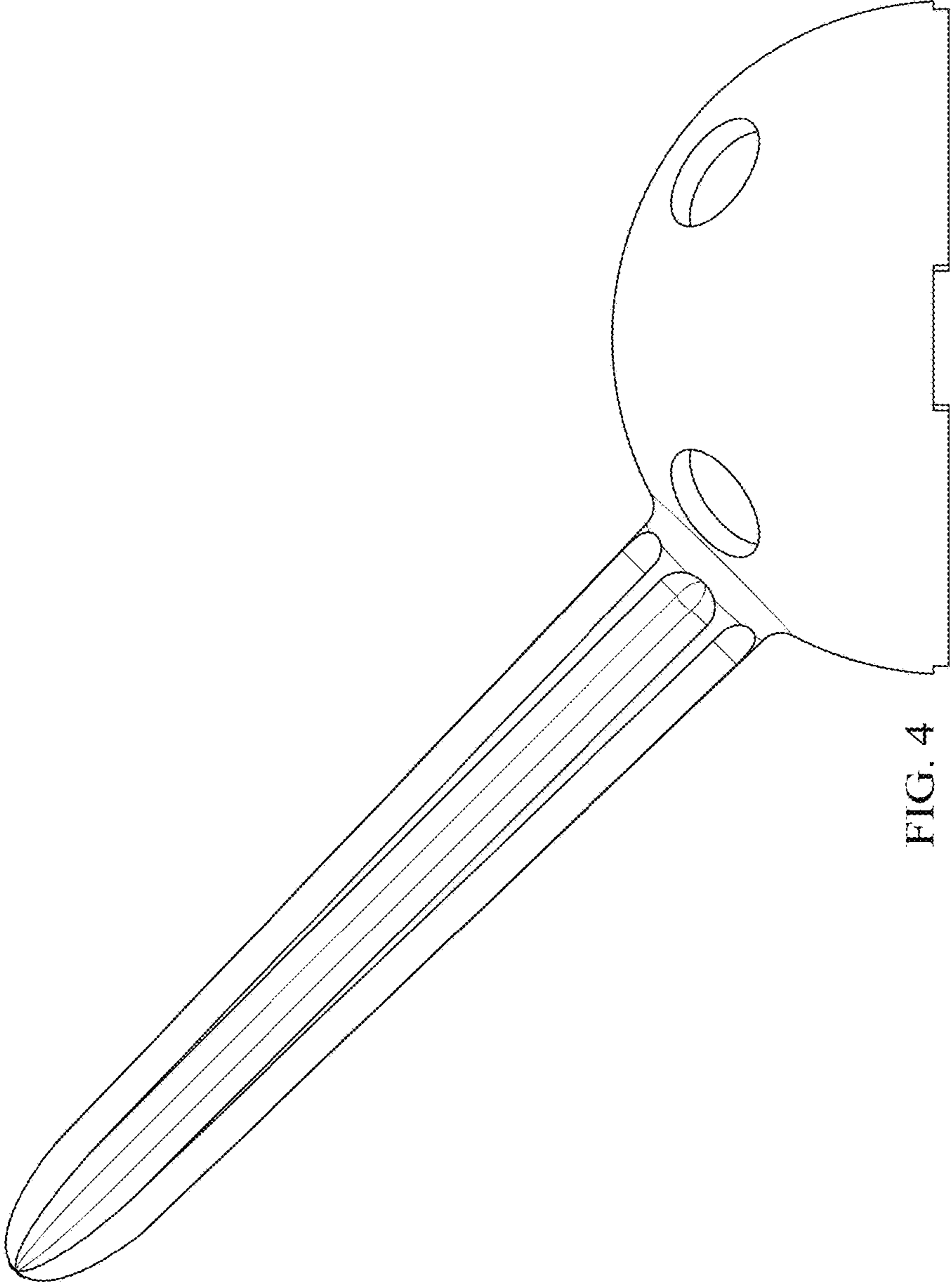

FIG. 4

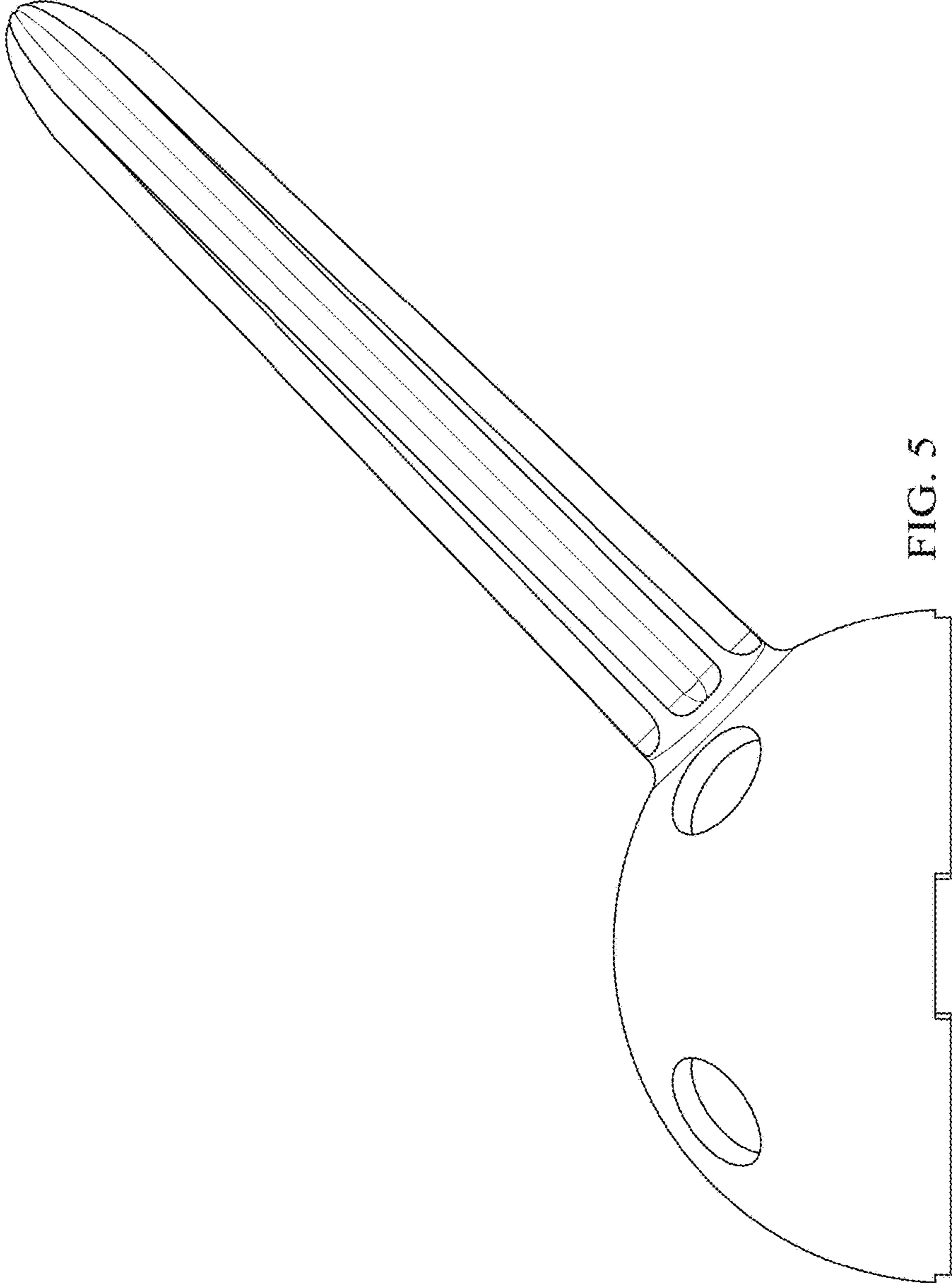

FIG. 5

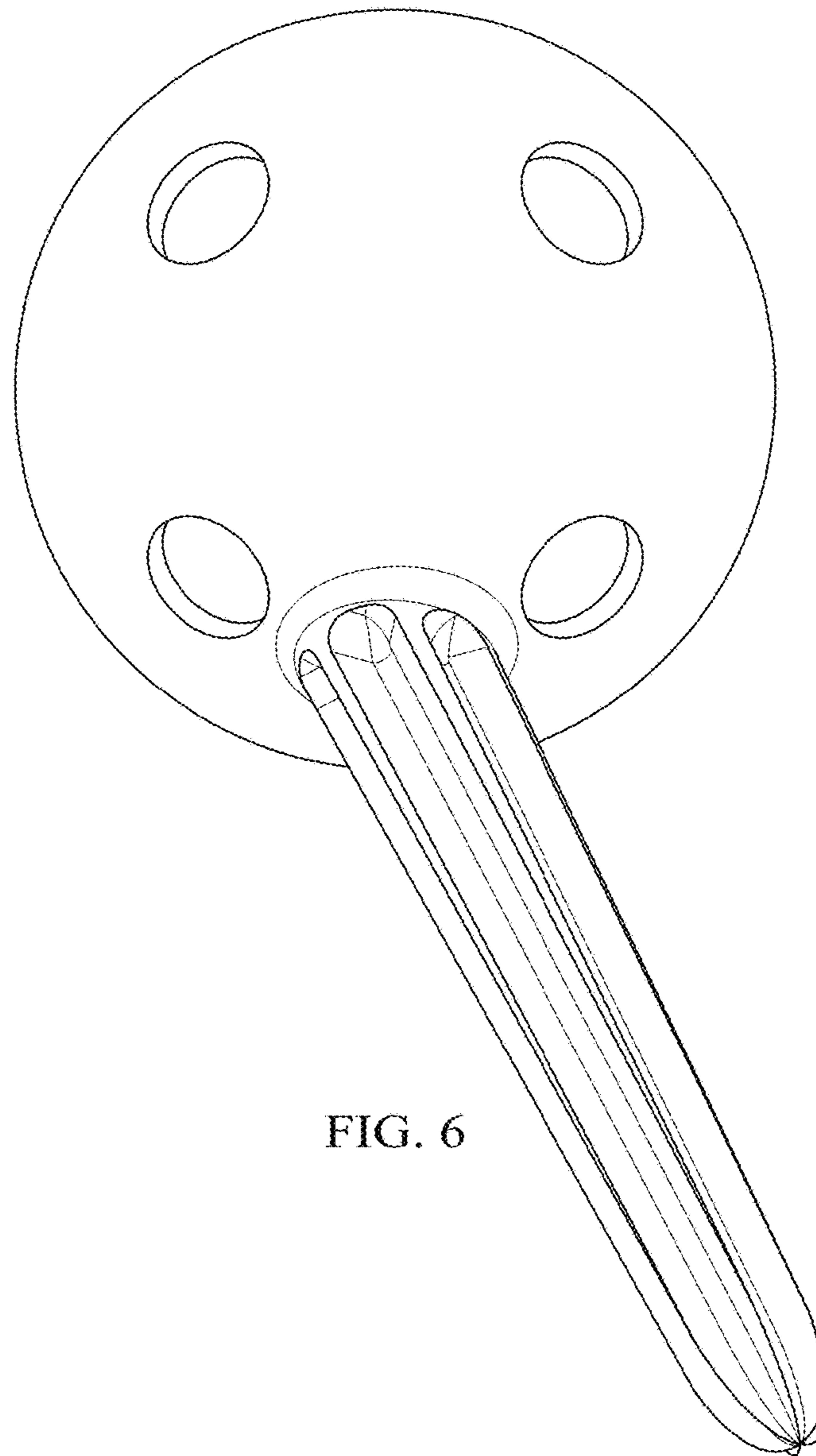

FIG. 6

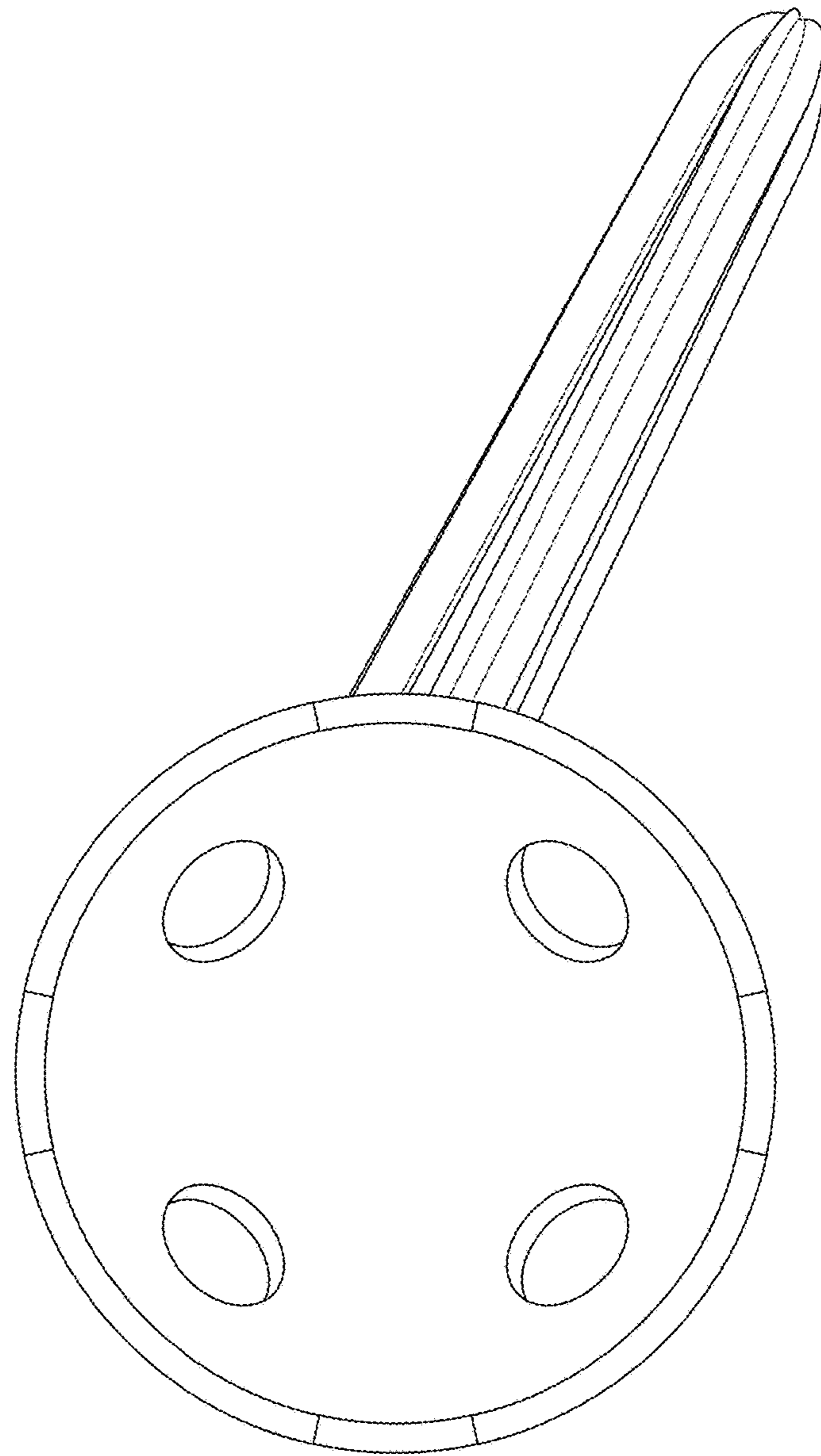

FIG. 7

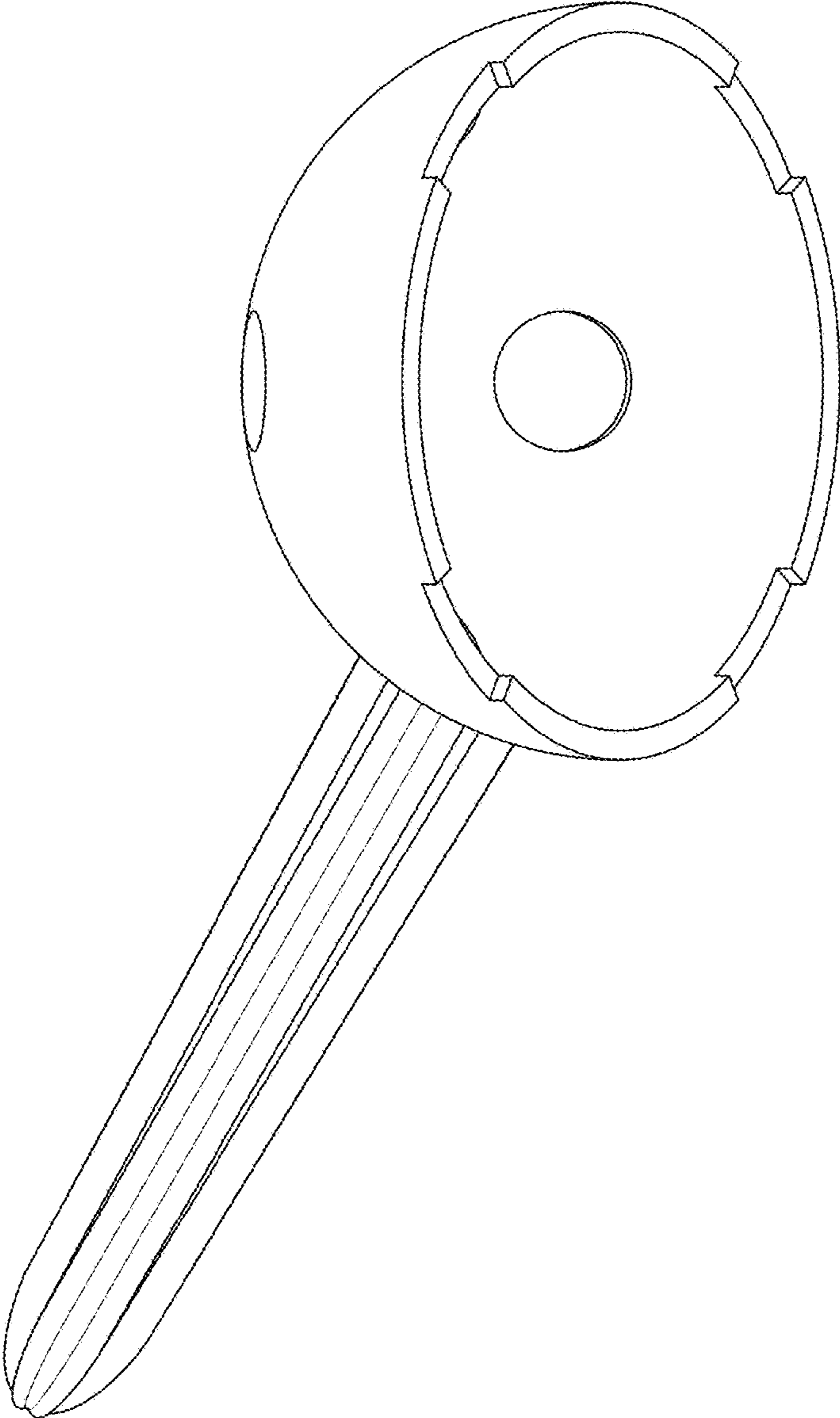

FIG. 8

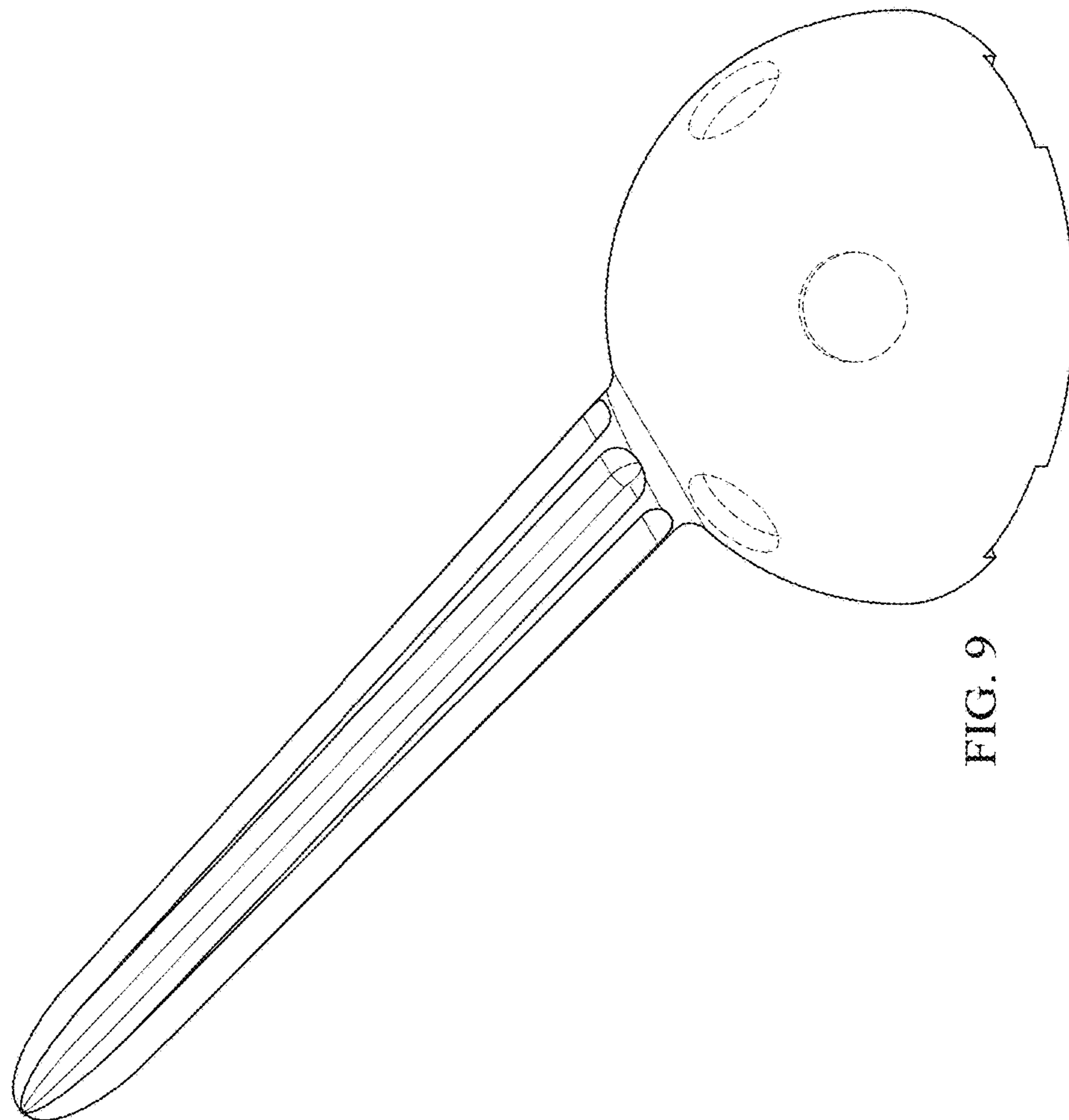

FIG. 9

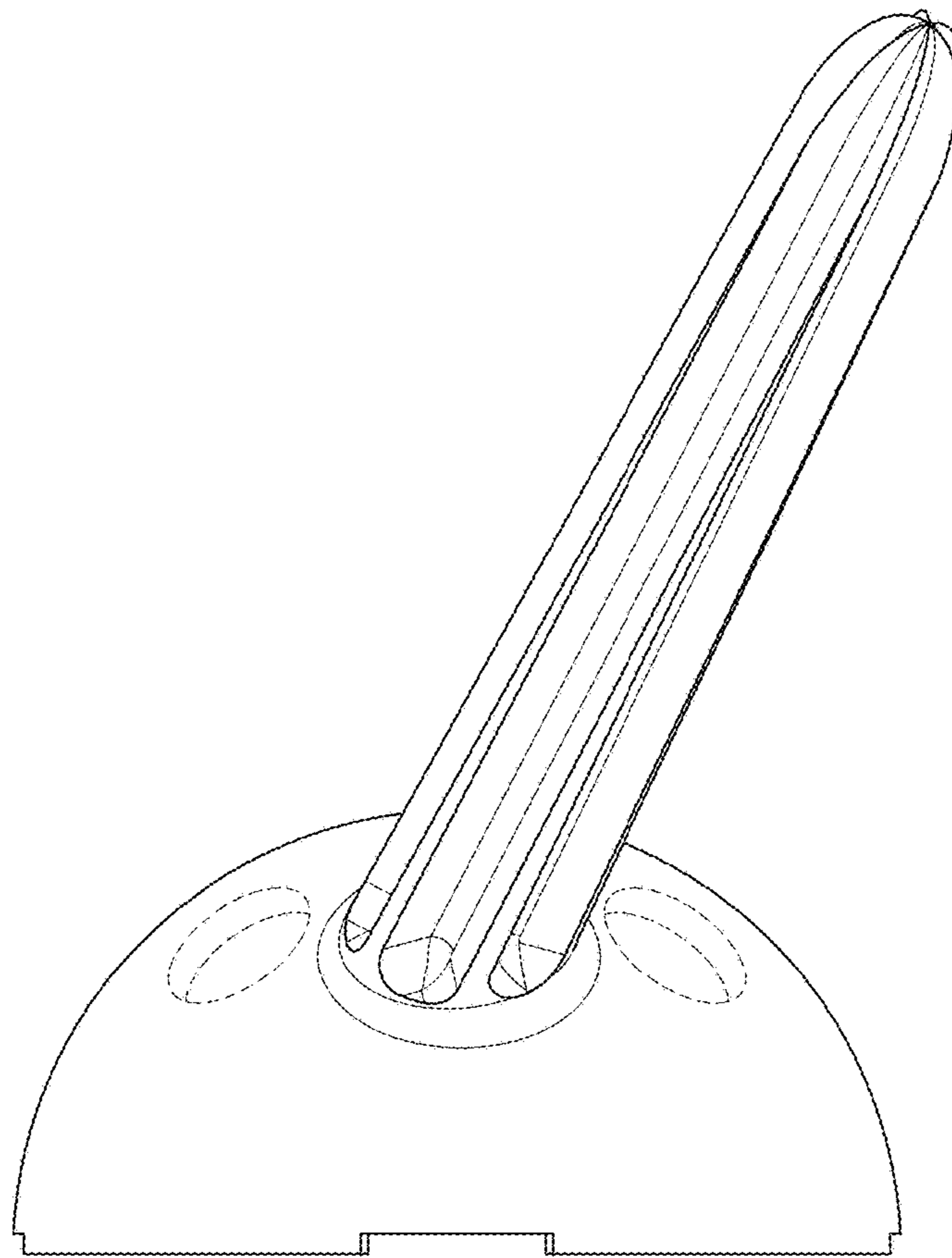

FIG. 10

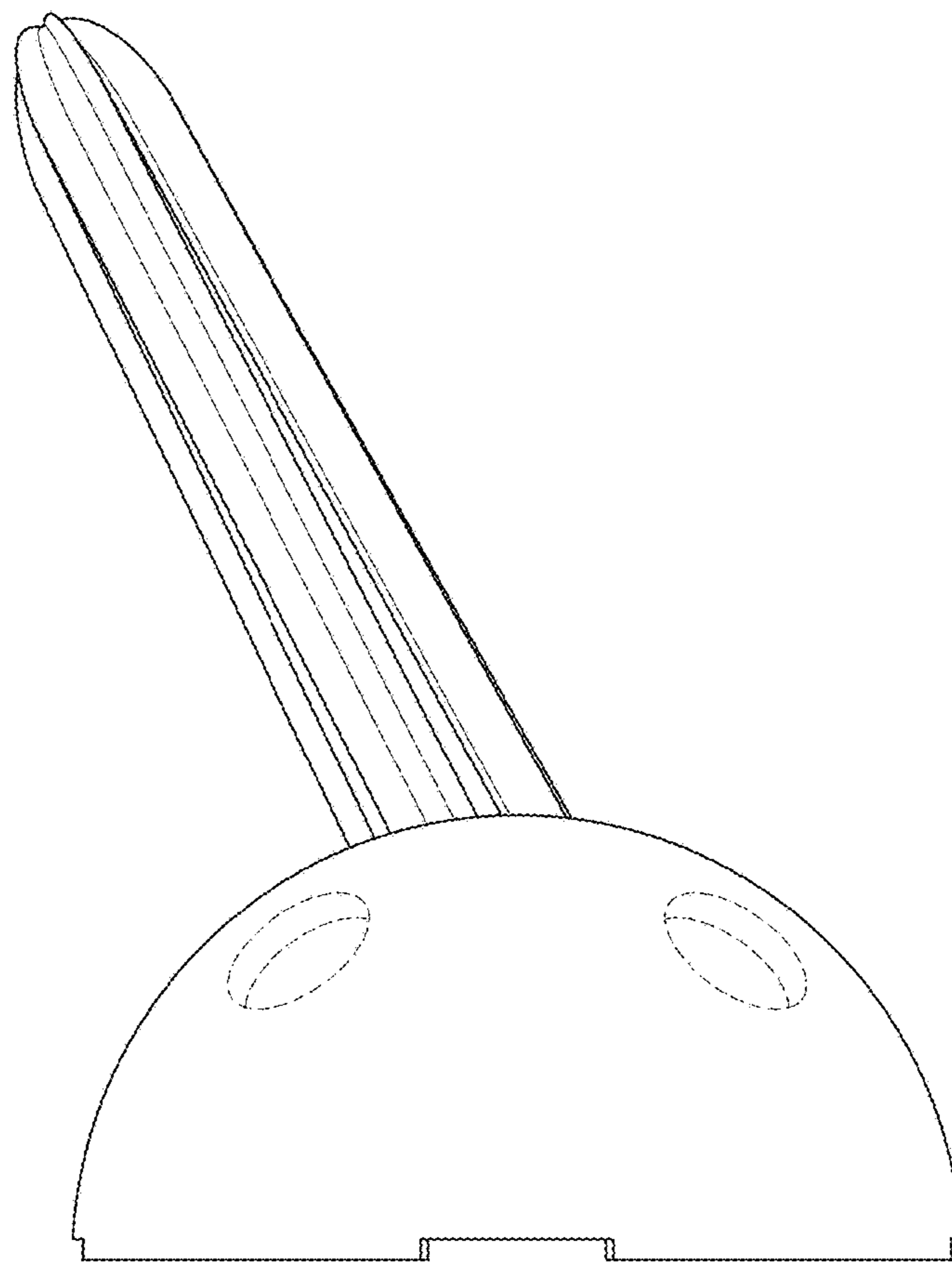

FIG. 11

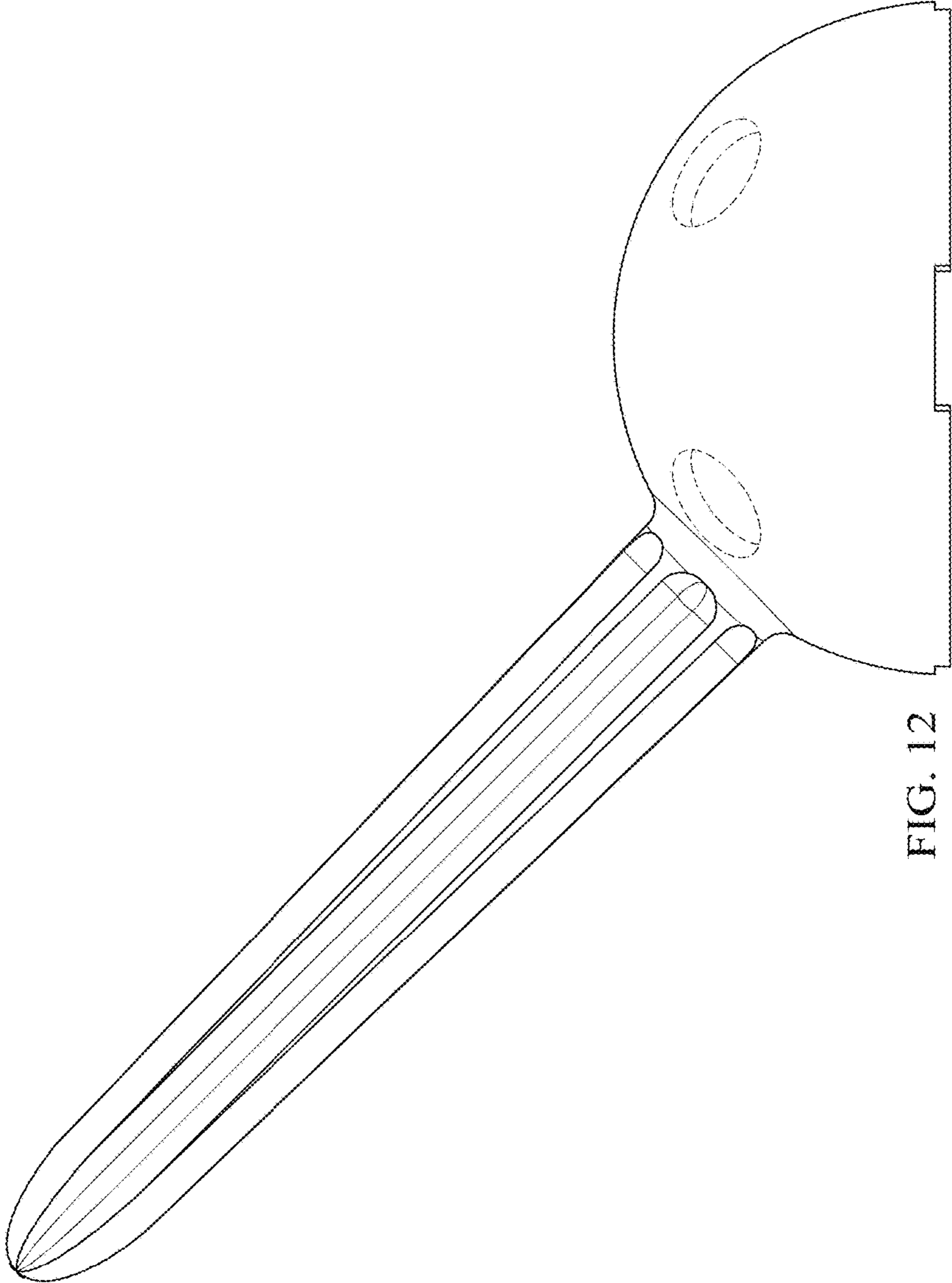

FIG. 12

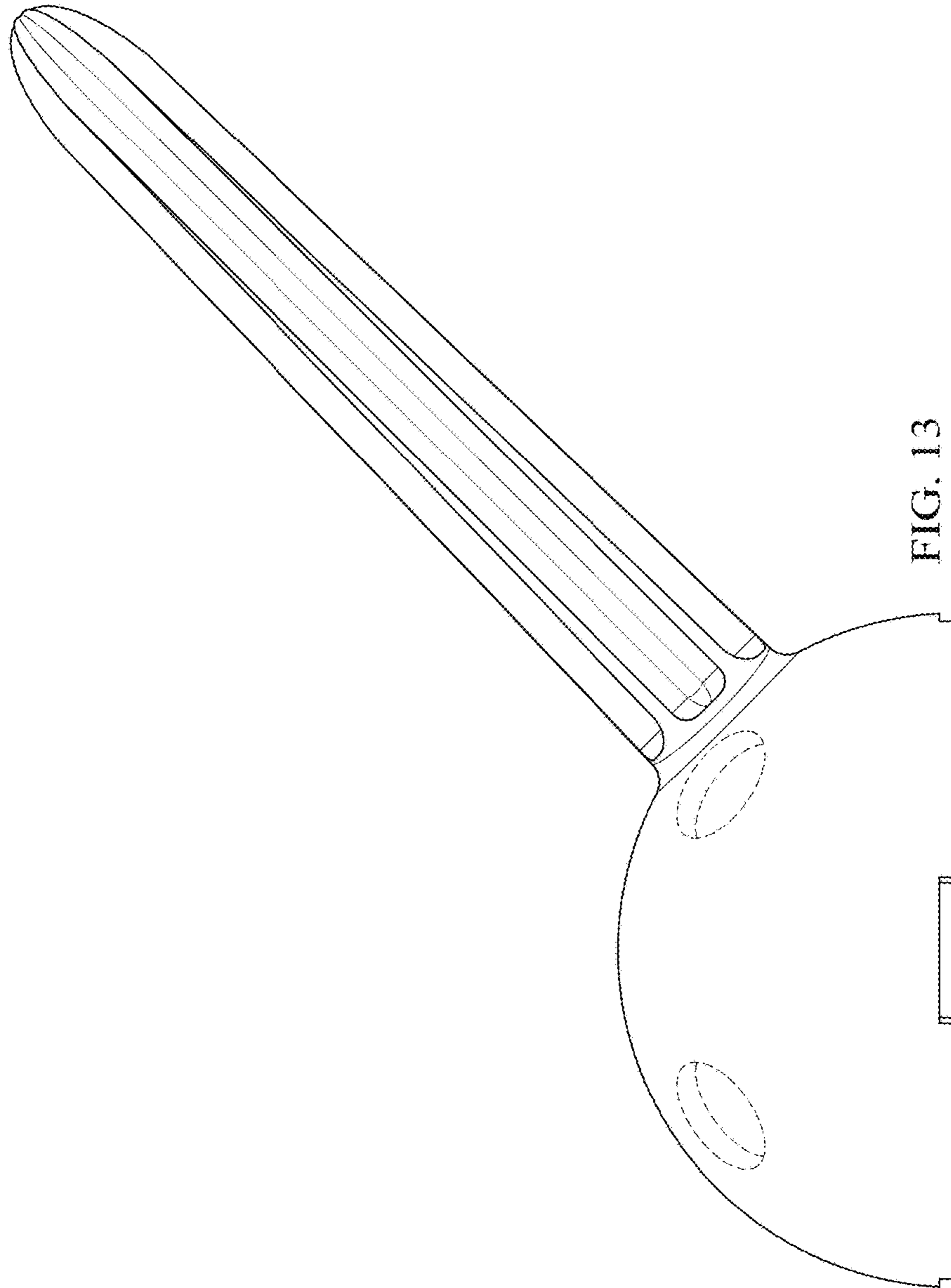

FIG. 13

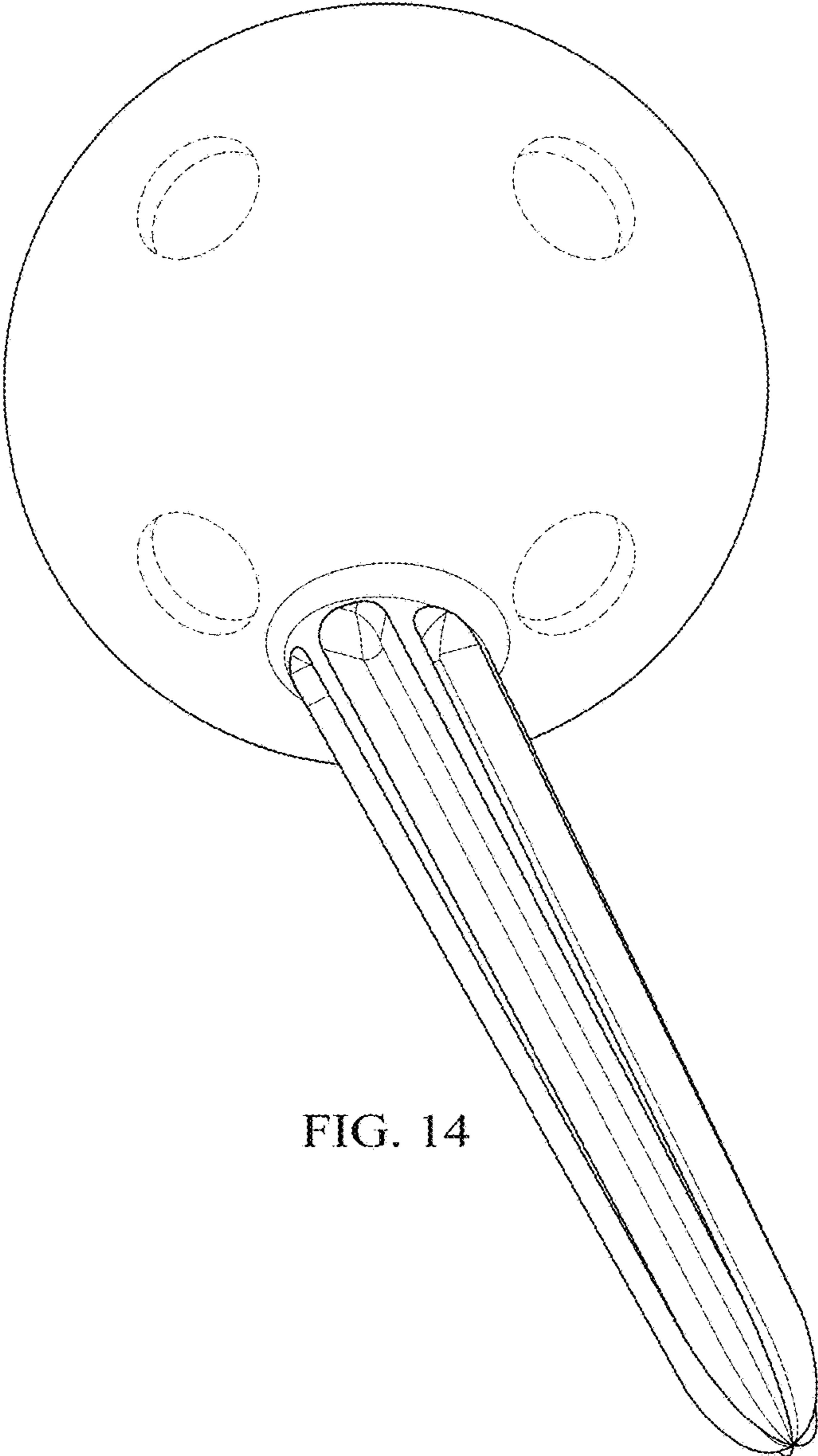

FIG. 14

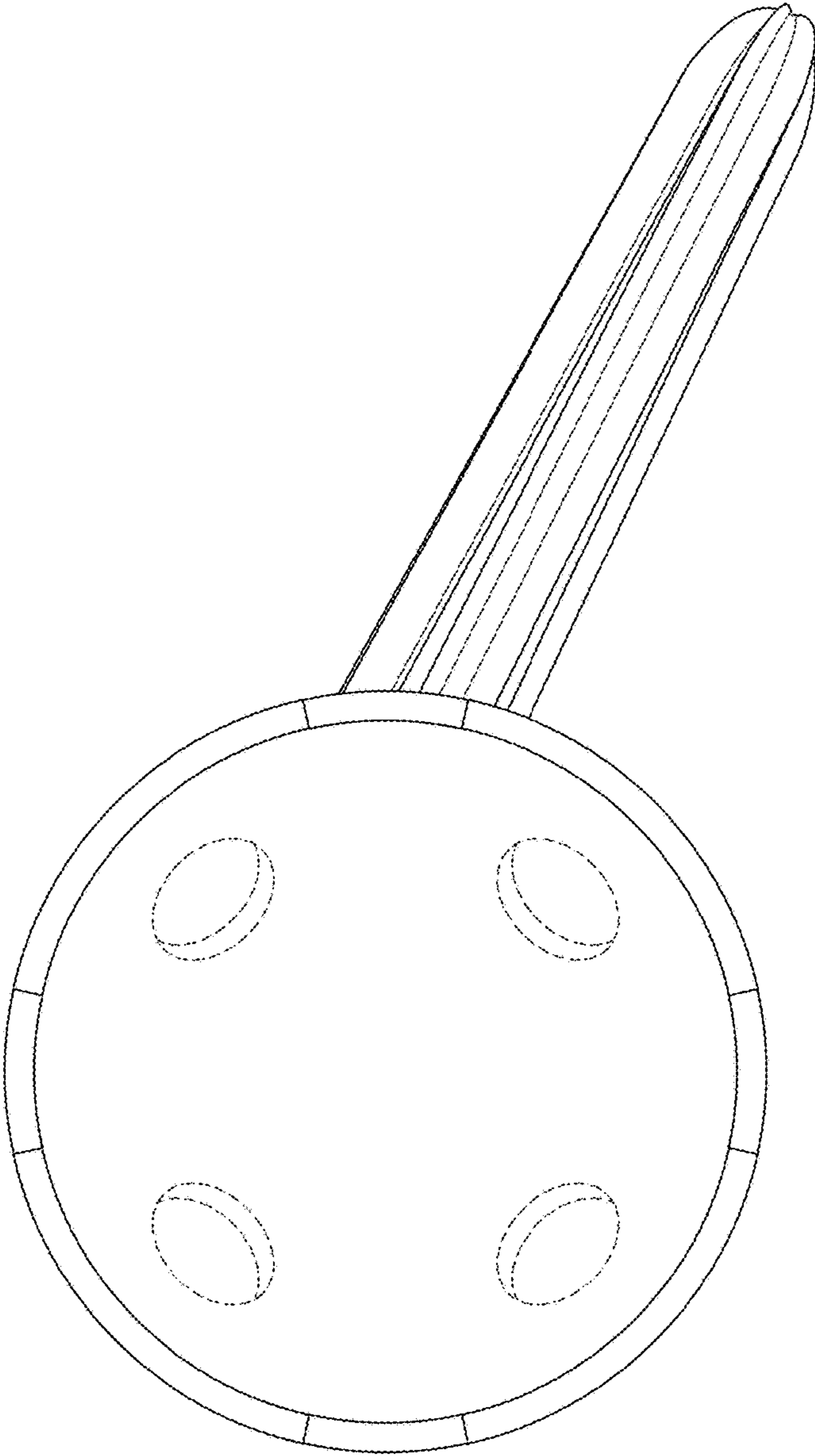

FIG. 15

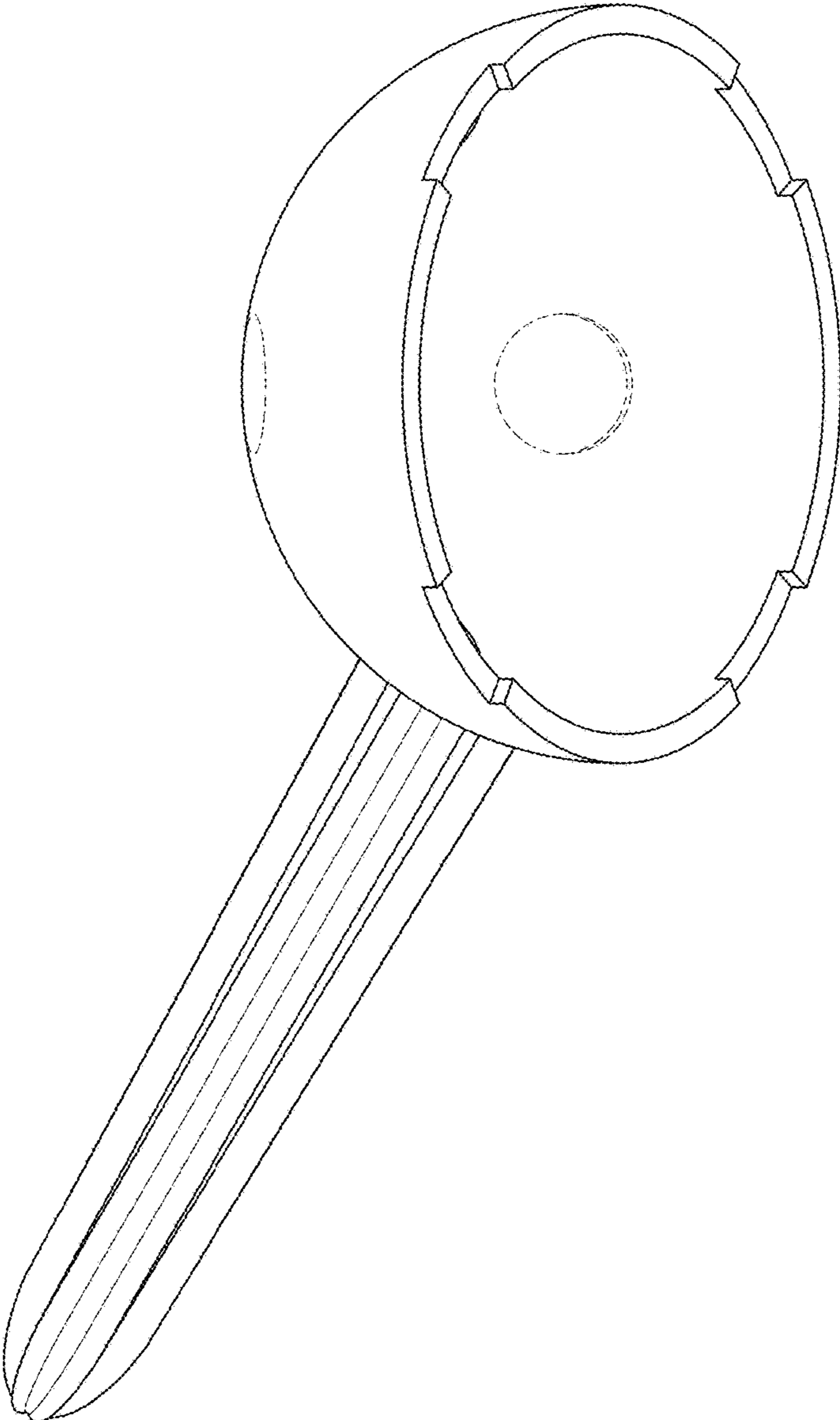

FIG. 16