



US00D858767S

(12) **United States Design Patent**  
**Baxter, III et al.**

(10) **Patent No.:** **US D858,767 S**

(45) **Date of Patent:** **\*\* Sep. 3, 2019**

(54) **SURGICAL CLIP APPLIER DEVICE**

(71) Applicant: **Ethicon LLC**, Guaynabo, PR (US)

(72) Inventors: **Chester O. Baxter, III**, Loveland, OH (US); **Matthew Corbin**, Loveland, OH (US)

(73) Assignee: **Ethicon LLC**, Guaynabo, PR (US)

(\*\*) Term: **15 Years**

(21) Appl. No.: **29/613,511**

(22) Filed: **Aug. 10, 2017**

(51) **LOC (12) Cl.** ..... **24-02**

(52) **U.S. Cl.**  
USPC ..... **D24/145**

(58) **Field of Classification Search**  
USPC ..... D24/145-146; 227/901-902  
CPC . A61B 17/128; Y10S 227/00; Y10S 227/901;  
Y10S 227/902

See application file for complete search history.

(56) **References Cited**

U.S. PATENT DOCUMENTS

- 5,171,247 A \* 12/1992 Hughett ..... A61B 17/1285  
606/142
- 5,192,288 A \* 3/1993 Thompson ..... A61B 17/128  
227/901
- 5,304,190 A \* 4/1994 Reckelhoff ..... A61B 17/32001  
606/170
- D354,564 S \* 1/1995 Medema ..... D24/145
- 5,409,498 A \* 4/1995 Braddock ..... A61B 17/1285  
227/901
- 5,700,271 A \* 12/1997 Whitfield ..... A61B 17/1285  
227/901

- 5,833,696 A \* 11/1998 Whitfield ..... A61B 17/1285  
606/143
- D502,994 S \* 3/2005 Blake, III ..... D24/145
- 6,869,435 B2 \* 3/2005 Blake, III ..... A61B 17/1285  
606/143
- 7,887,553 B2 \* 2/2011 Lehman ..... A61B 17/1285  
227/175.1
- 8,579,918 B2 \* 11/2013 Whitfield ..... A61B 17/128  
606/142
- 9,968,363 B2 \* 5/2018 Blake, III ..... A61B 17/1285

\* cited by examiner

*Primary Examiner* — Wan Laymon

(74) *Attorney, Agent, or Firm* — Mintz Levin Cohn Ferris Glovsky and Popeo, P.C.

(57) **CLAIM**

The ornamental design for a surgical clip applier device, as shown and described.

**DESCRIPTION**

FIG. 1 is a perspective view of a surgical clip applier device having a new design for a rotation knob; FIG. 2 is a back view of the clip applier device of FIG. 1; FIG. 3 is a front view of the clip applier device of FIG. 1; FIG. 4 is a right side view of the clip applier device of FIG. 1; FIG. 5 is a left side view of the clip applier device of FIG. 1; FIG. 6 is a top view of the clip applier device of FIG. 1; and, FIG. 7 is a bottom view of the clip applier device of FIG. 1. The broken lines in the drawings form no part of the claimed design.

**1 Claim, 5 Drawing Sheets**

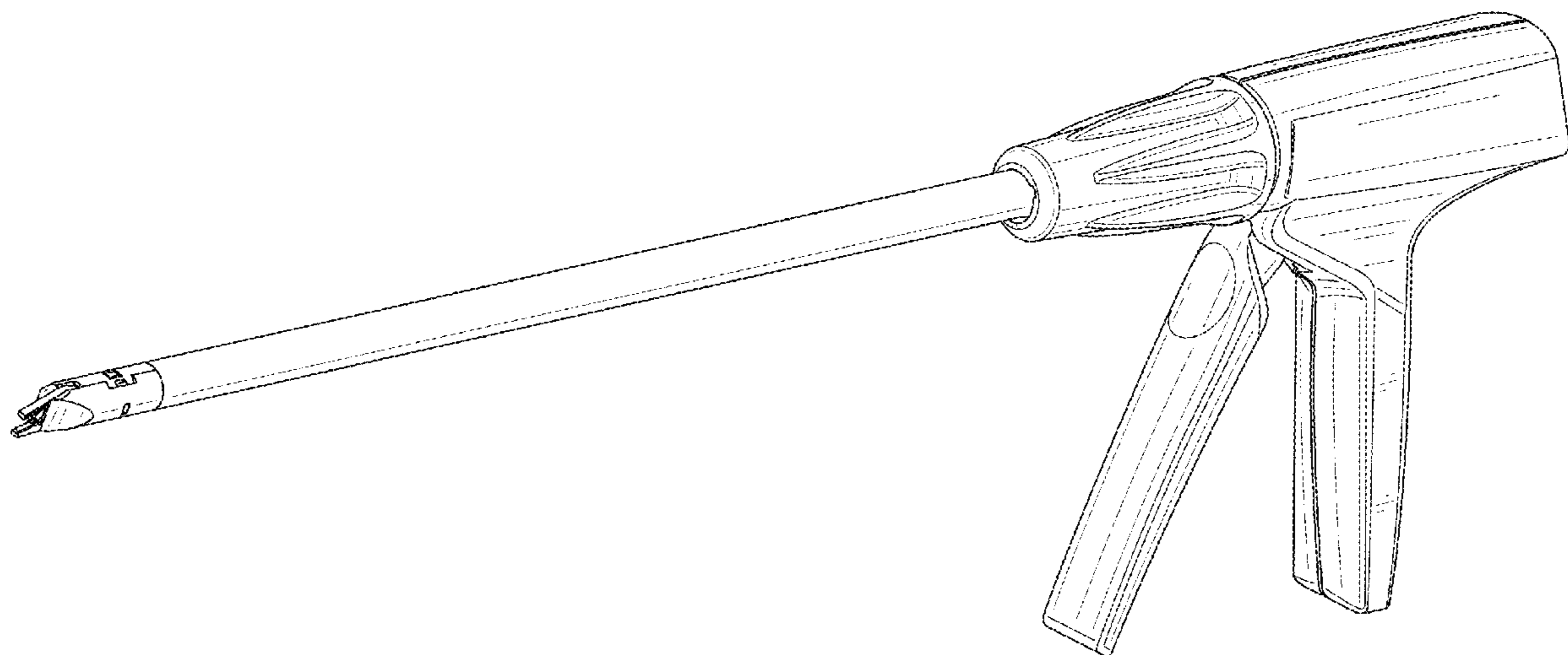

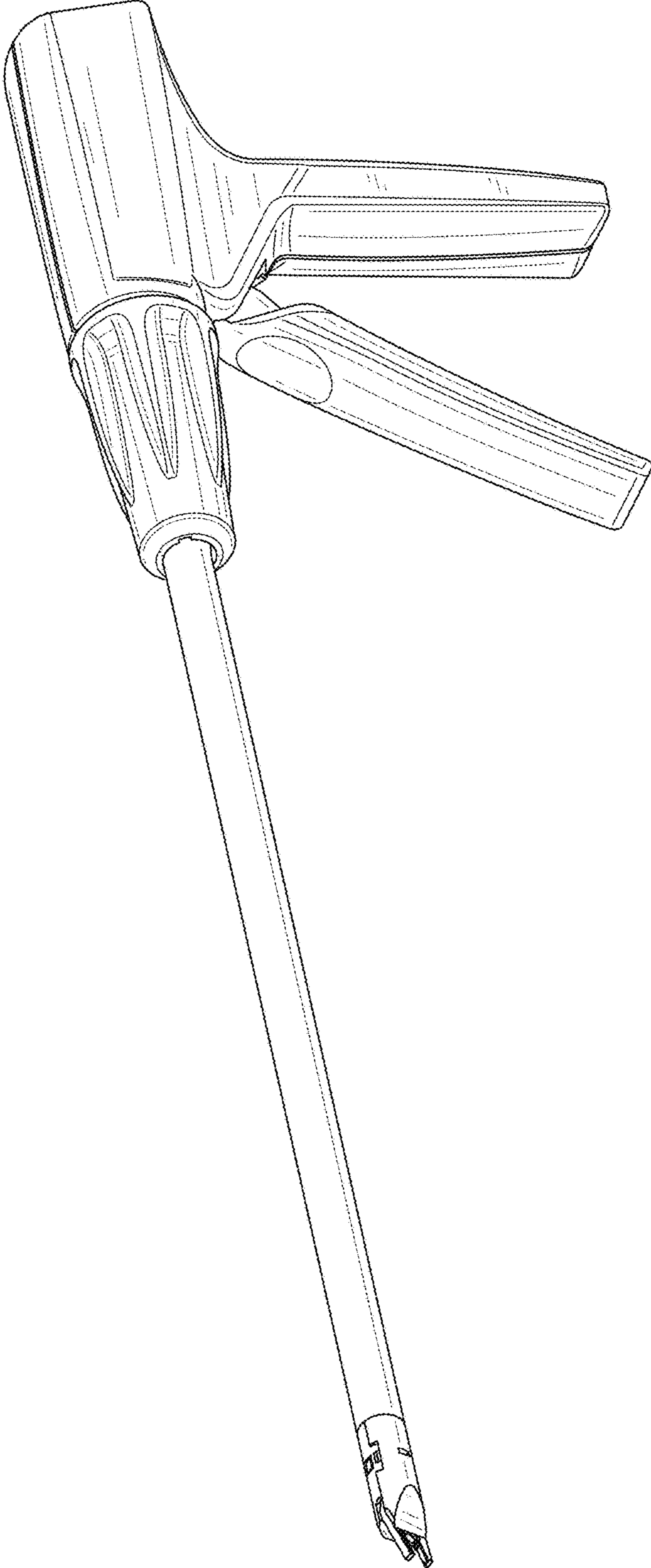

FIG. 1

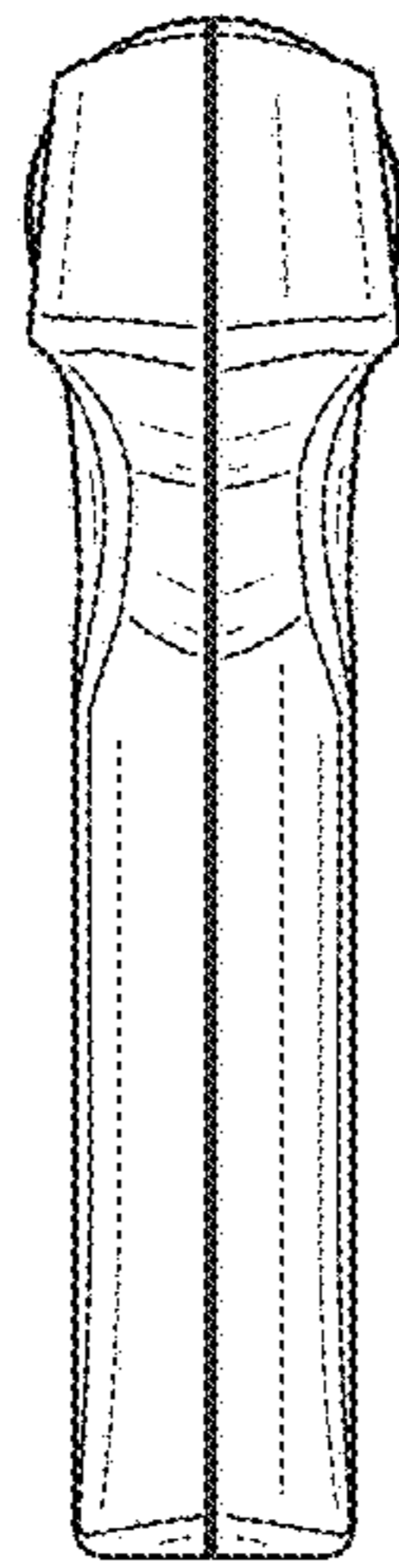

FIG. 2

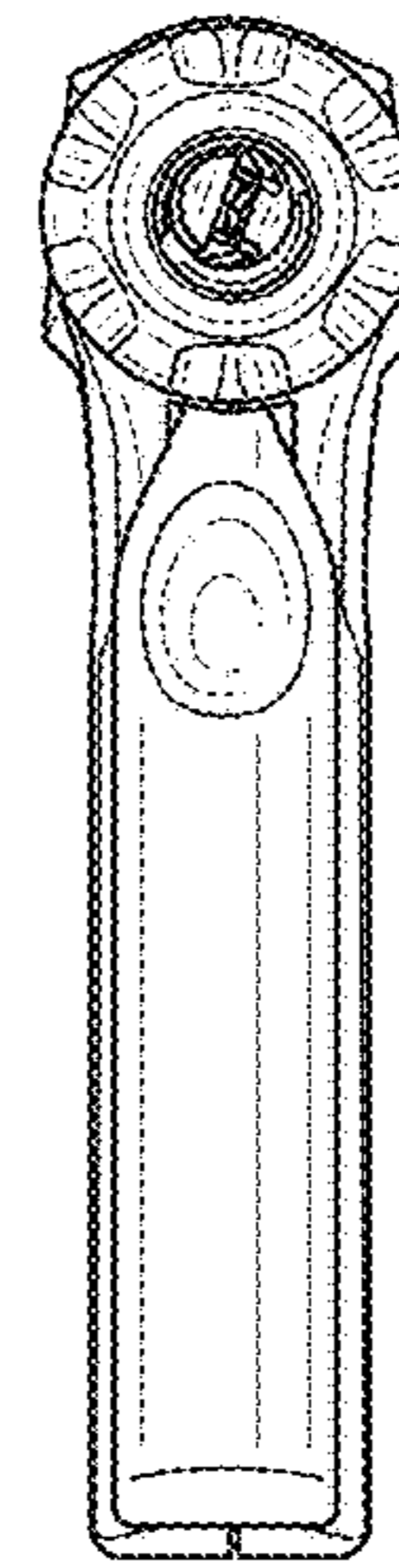

FIG. 3

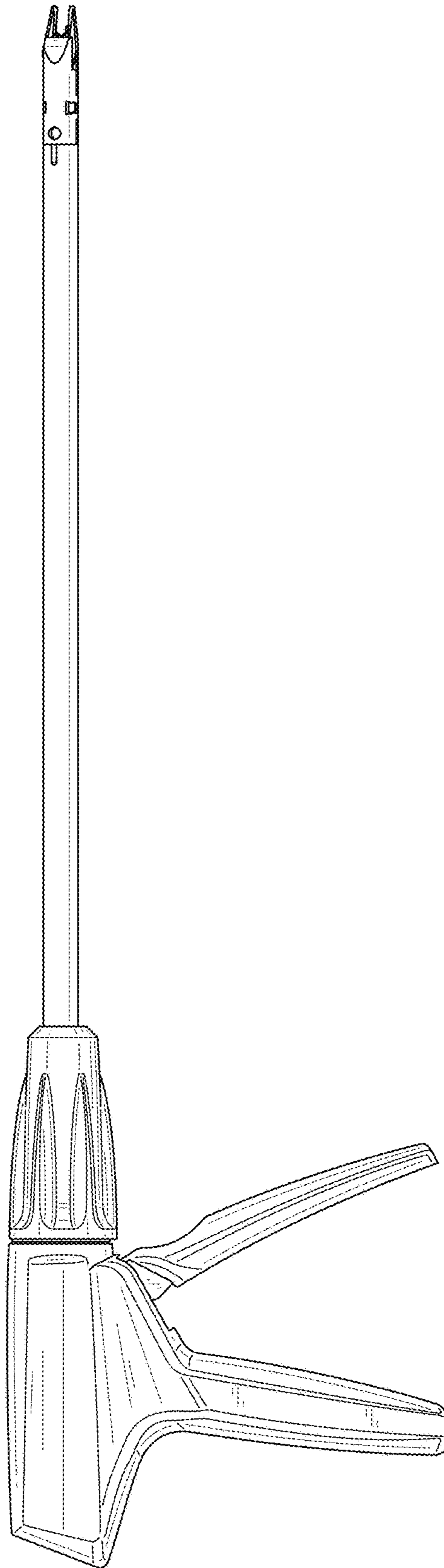

FIG. 4

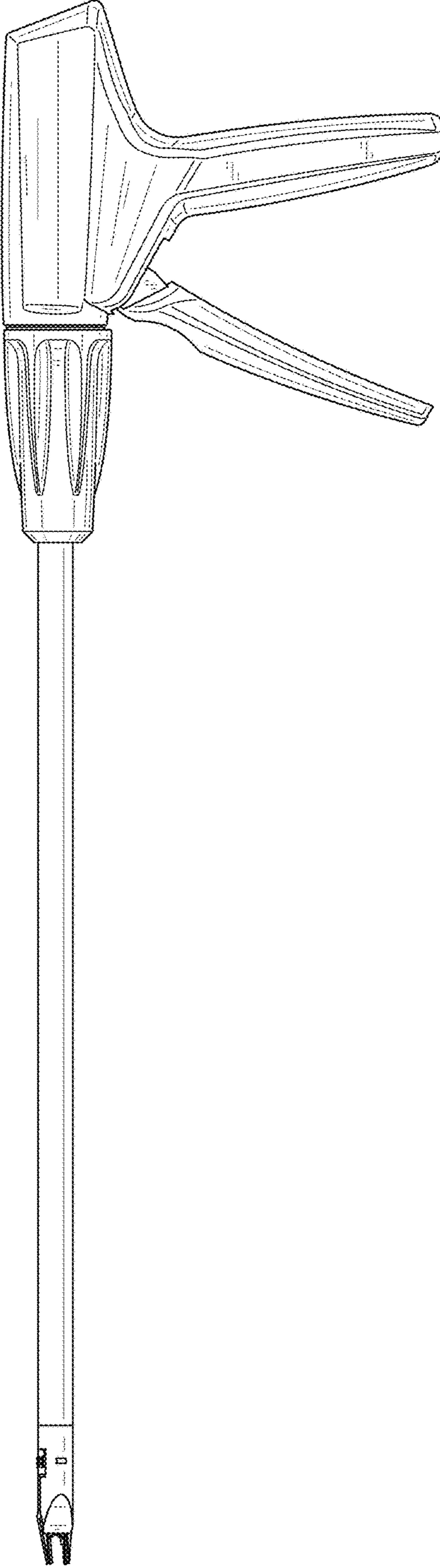

FIG. 5

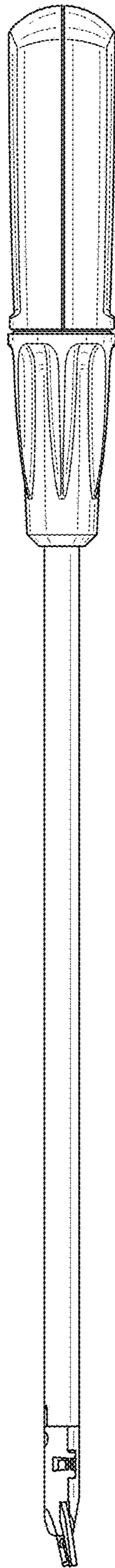

FIG. 6

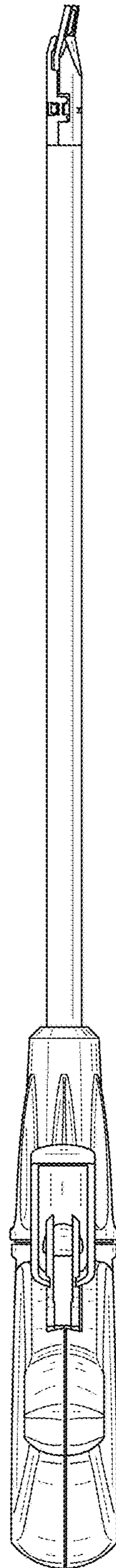

FIG. 7