



US00D858722S

(12) **United States Design Patent** (10) **Patent No.:** **US D858,722 S**
Bucher (45) **Date of Patent:** **** Sep. 3, 2019**

(54) **SINK**

FOREIGN PATENT DOCUMENTS

(71) Applicant: **AS America, Inc.**, Piscataway, NJ (US)

CA 2 639 213 2/2014
CA 2882716 A1 * 8/2015 E03C 1/186

(72) Inventor: **Christophe Bucher**, Hillsborough, NJ (US)

(Continued)

(73) Assignee: **AS America, Inc.**, Piscataway, NJ (US)

OTHER PUBLICATIONS

(**) Term: **15 Years**

Home Depot, Farmhouse sink, reviewed Feb. 4, 2014, [online], [visited Dec. 3, 2018].<URL: https://www.homedepot.com/p/Whitehaus-Collection-Duet-Reversible-Farmhaus-Apron-Front-Fireclay-30-in-Single-Bowl-Kitchen-Sink-in-White-WH3018-WH/203865941?MERCH=REC--PIPHorizontal2_rr--203866193--203865941--N> (Year: 2014).*

(21) Appl. No.: **29/642,676**

(Continued)

(22) Filed: **Mar. 30, 2018**

(51) **LOC (12) Cl.** **23-02**

(52) **U.S. Cl.**
USPC **D23/284**

(58) **Field of Classification Search**
USPC ... D23/270, 284, 285, 290, 289, 293.1, 303, D23/308, 499; D6/524, 573, 663-666, D6/671
CPC ... E03C 1/12; E03C 1/18; E03C 1/181; A47K 1/04; A47B 77/06; A47J 47/20
See application file for complete search history.

Primary Examiner — Sheryl Lane
Assistant Examiner — Samantha N Wood
(74) *Attorney, Agent, or Firm* — Morrison & Foerster LLP

(56) **References Cited**

(57) **CLAIM**

U.S. PATENT DOCUMENTS

I claim the ornamental design for a sink, as shown and described.

- 6,182,305 B1 2/2001 O'Connell et al.
- D498,291 S 11/2004 Bayer
- D504,496 S 4/2005 Bayer
- D505,188 S 5/2005 Bayer
- D508,555 S * 8/2005 Ziemann D23/293.1
- D518,561 S 4/2006 Gordon
- D523,540 S 6/2006 Gordon
- D541,912 S * 5/2007 Ziemann D23/293.1
- D547,833 S 7/2007 Mahon
- D548,311 S 8/2007 Mahon
- D585,126 S 1/2009 Eilmus et al.
- D586,445 S 2/2009 Ziemann et al.
- D587,351 S 2/2009 Eilmus et al.
- D588,246 S 3/2009 Eilmus et al.
- D601,675 S 10/2009 Booth et al.
- D603,484 S 11/2009 Eilmus
- D622,826 S * 8/2010 Helmer D23/293.1
- D627,449 S * 11/2010 Eckhaus D23/308
- D656,228 S 3/2012 Booth

(Continued)

DESCRIPTION

FIG. 1 is a front perspective view of a sink showing my new design;
FIG. 2 is a front view thereof;
FIG. 3 is a rear view thereof;
FIG. 4 is a side view thereof;
FIG. 5 is a side view of the opposite side of FIG. 4;
FIG. 6 is a top view thereof; and,
FIG. 7 is a bottom view thereof.
The sink is shown with symbolic breaks in its length. The appearance of any portion of the article between the break lines forms no part of the claimed design.

1 Claim, 7 Drawing Sheets

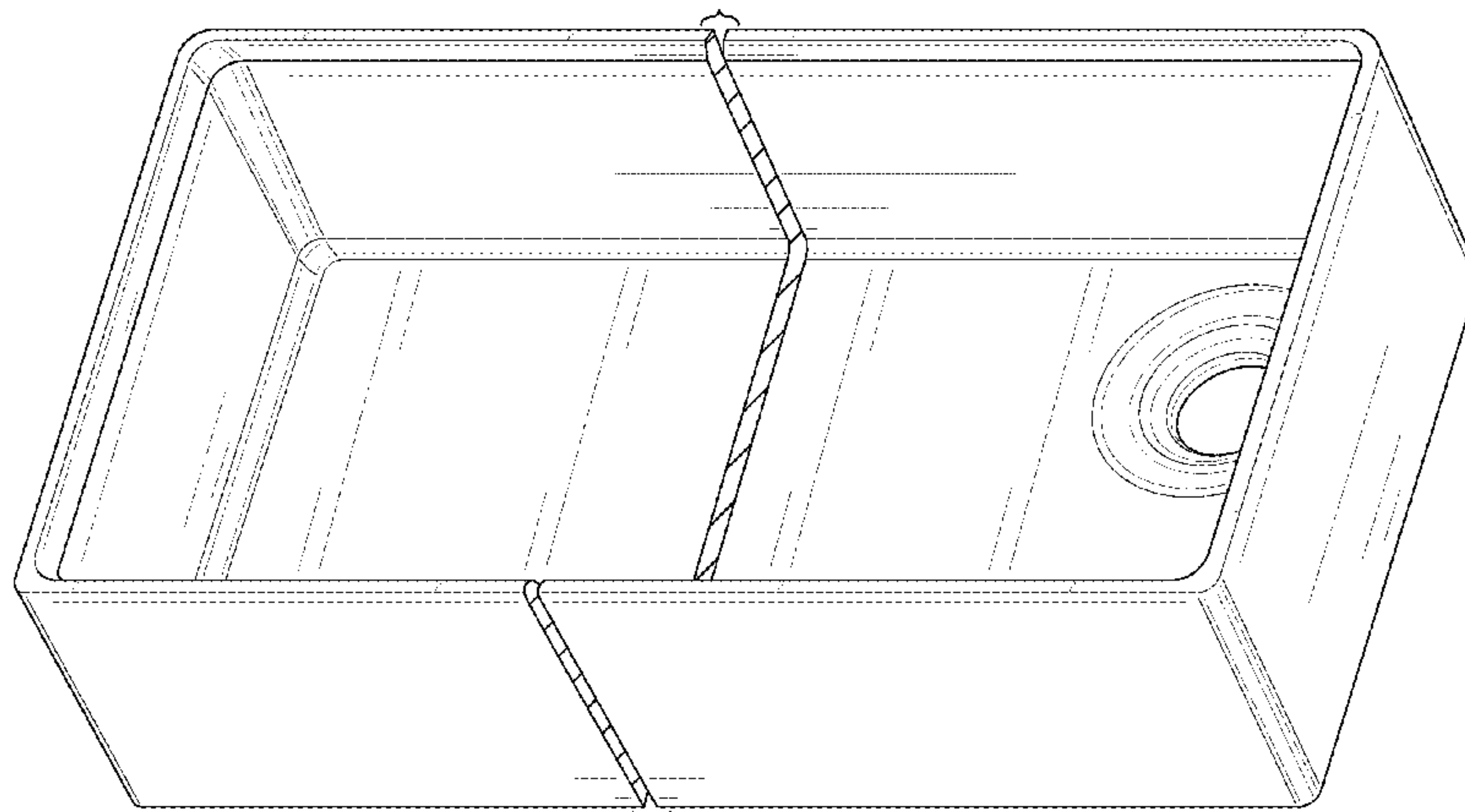

(56)

References Cited

U.S. PATENT DOCUMENTS

D669,560 S 10/2012 Booth
 D670,364 S 11/2012 Miller et al.
 D677,772 S * 3/2013 Mendoza D23/293.1
 D703,799 S * 4/2014 Eilmus D23/308
 D767,738 S * 9/2016 Osterroth D23/284
 RE46,298 E 2/2017 Eilmus
 9,574,333 B2 2/2017 O'Brien et al.
 D782,018 S 3/2017 Eilmus et al.
 9,775,470 B2 10/2017 Eilmus et al.
 9,783,967 B2 10/2017 Jain et al.
 D804,620 S 12/2017 Palazzolo et al.
 D816,197 S 4/2018 Chong et al.
 2006/0242761 A1 11/2006 Babick et al.
 2012/0266377 A1* 10/2012 Eilmus E03C 1/186
 4/638

FOREIGN PATENT DOCUMENTS

CN 301999934 7/2012
 CN 201530247212 * 7/2015
 EP 0 900 543 3/1999
 EP 1 776 898 11/2010
 EP 1 856 339 12/2012

OTHER PUBLICATIONS

First Rectification Notification dated Dec. 18, 2018, directed to CN Application No. 201830544103.3; 2 pages.
 Shalees Diner Decor. (Dec. 11, 2015) "Single Basin Kitchen Sink Photo," located at <<https://shaleesdiner.com/the-advantages-of-single-basin-kitchen-sink/single-basin-kitchen-sink-photo/>> (1 page).
 Notification to Grant Patent Right dated Mar. 25, 2019, directed to CN Application No. 201830544103.3; 6 pages.

* cited by examiner

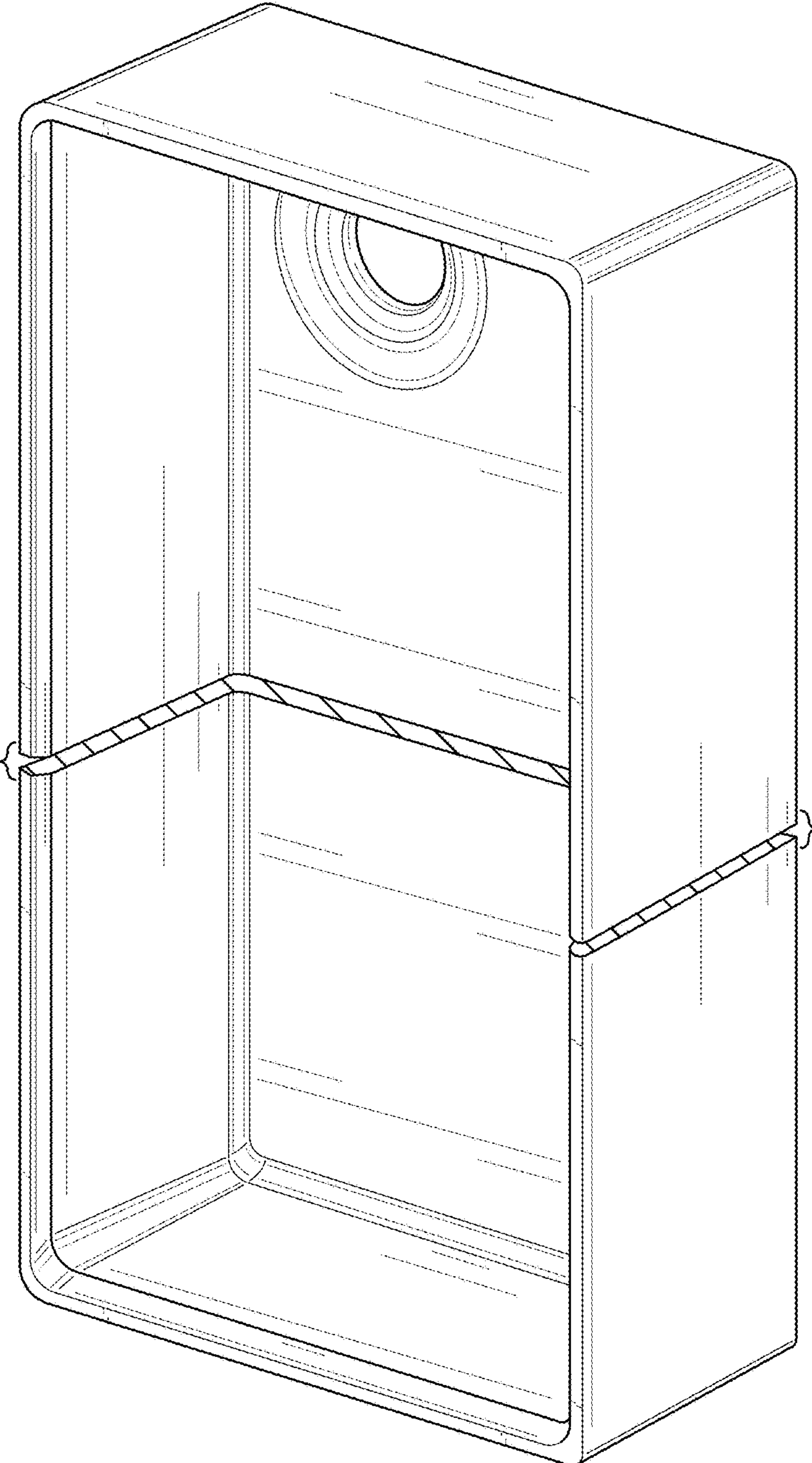

FIG. 1

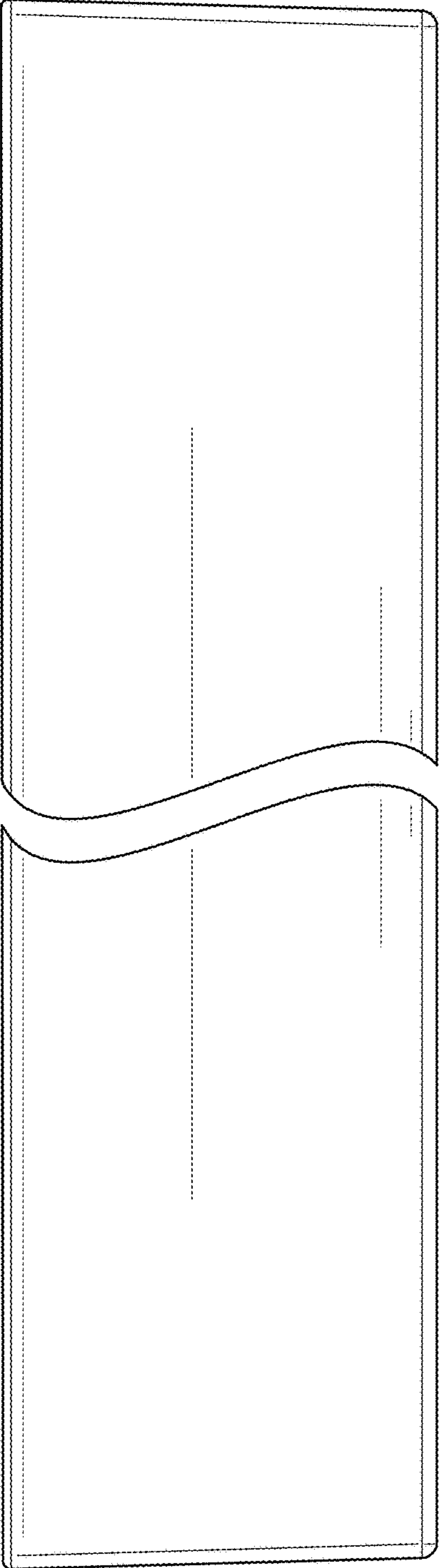

FIG. 2

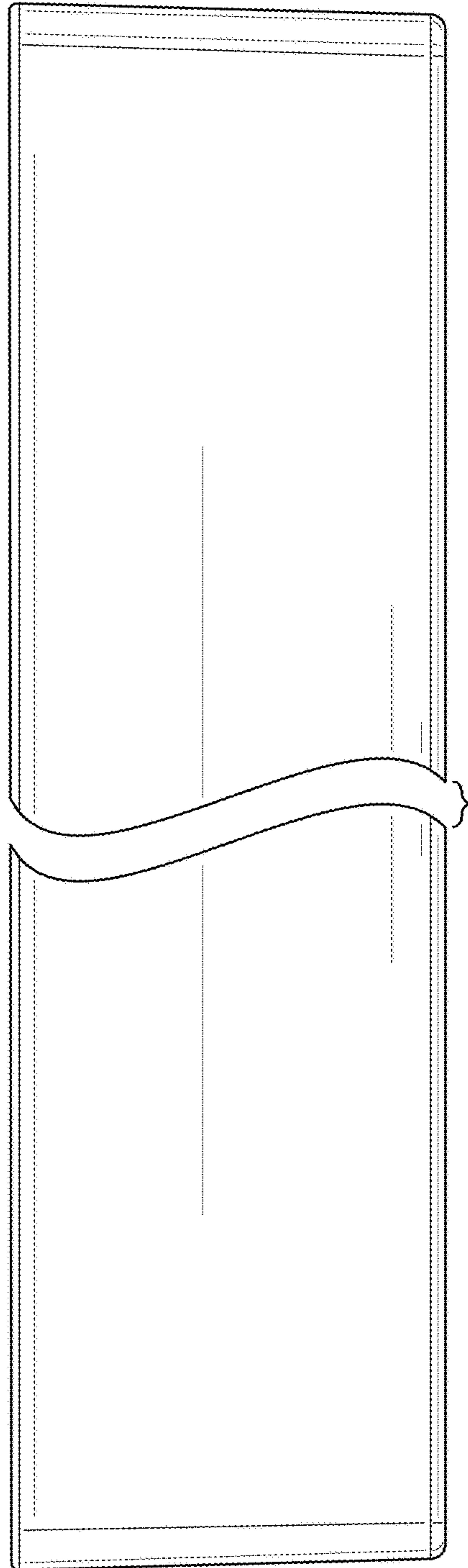

FIG. 3

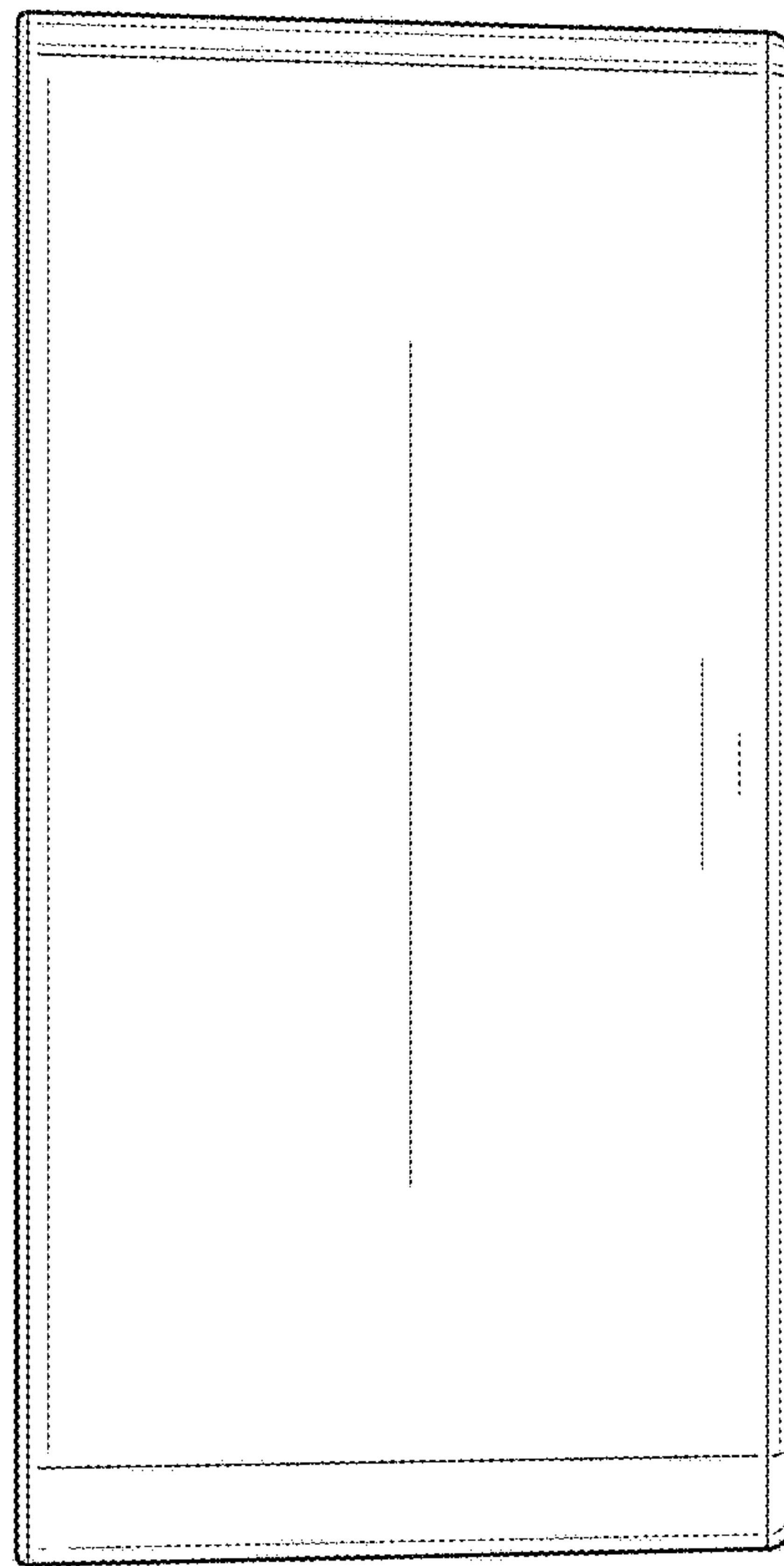

FIG. 4

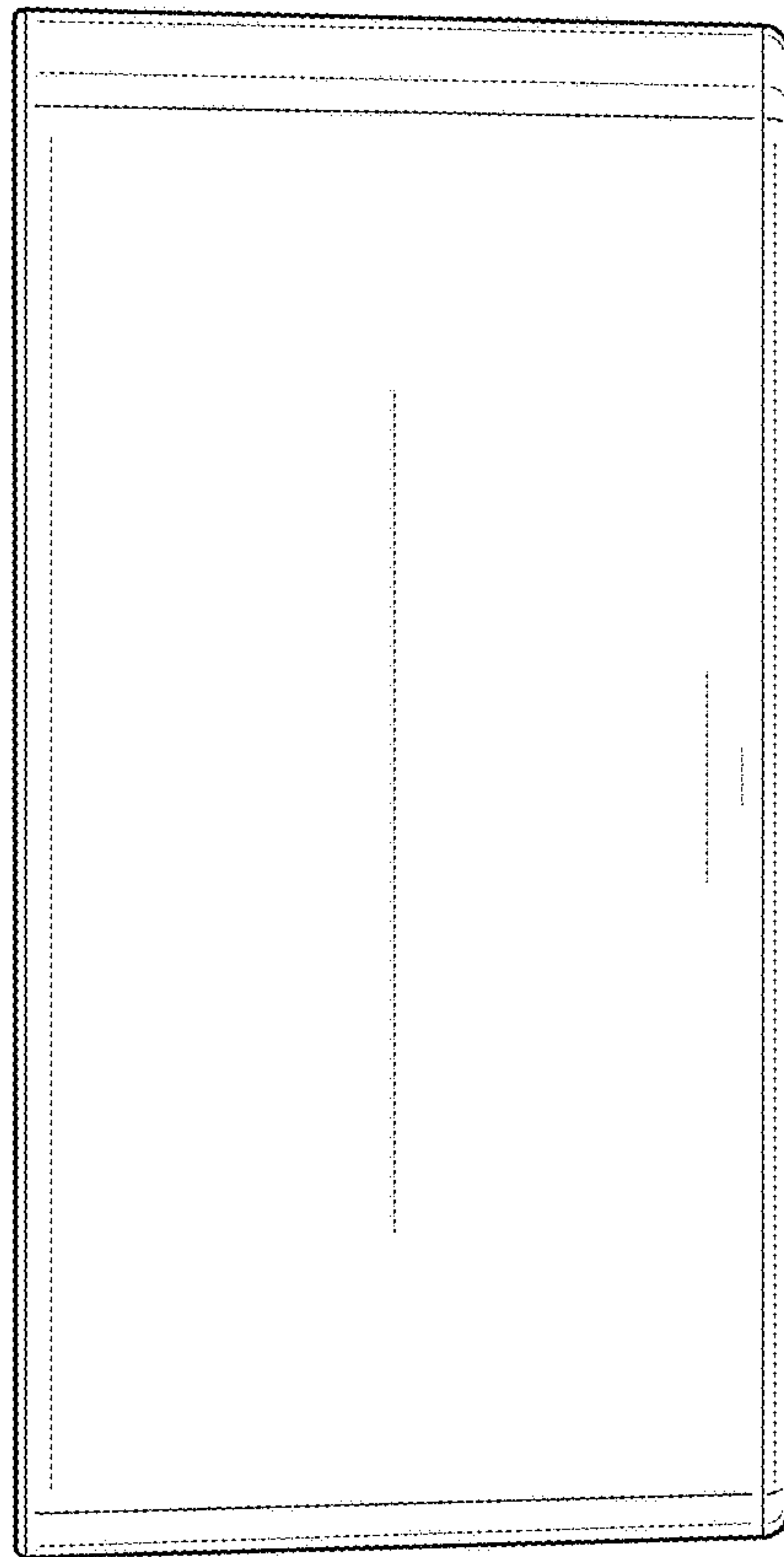

FIG. 5

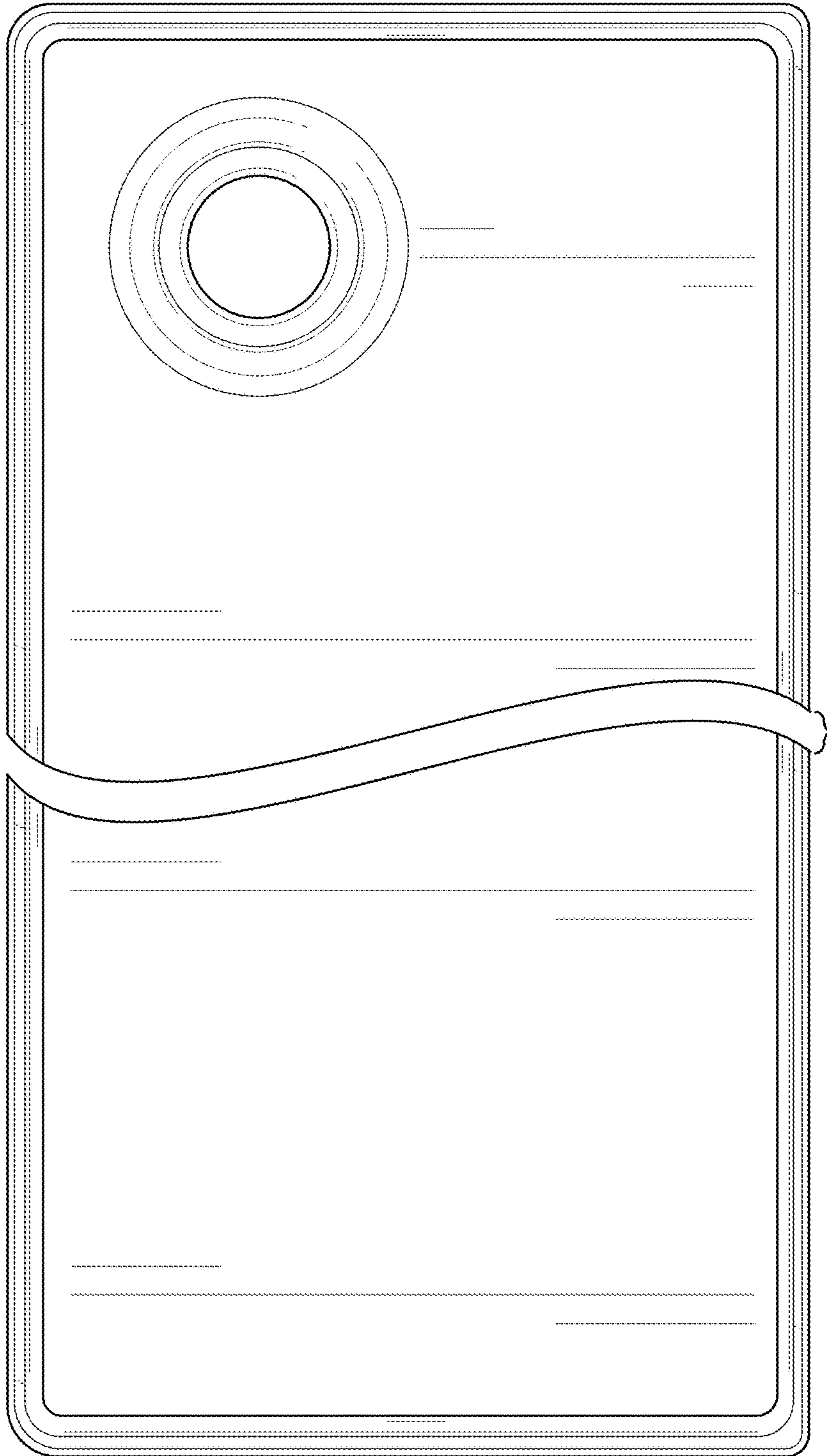

FIG. 6

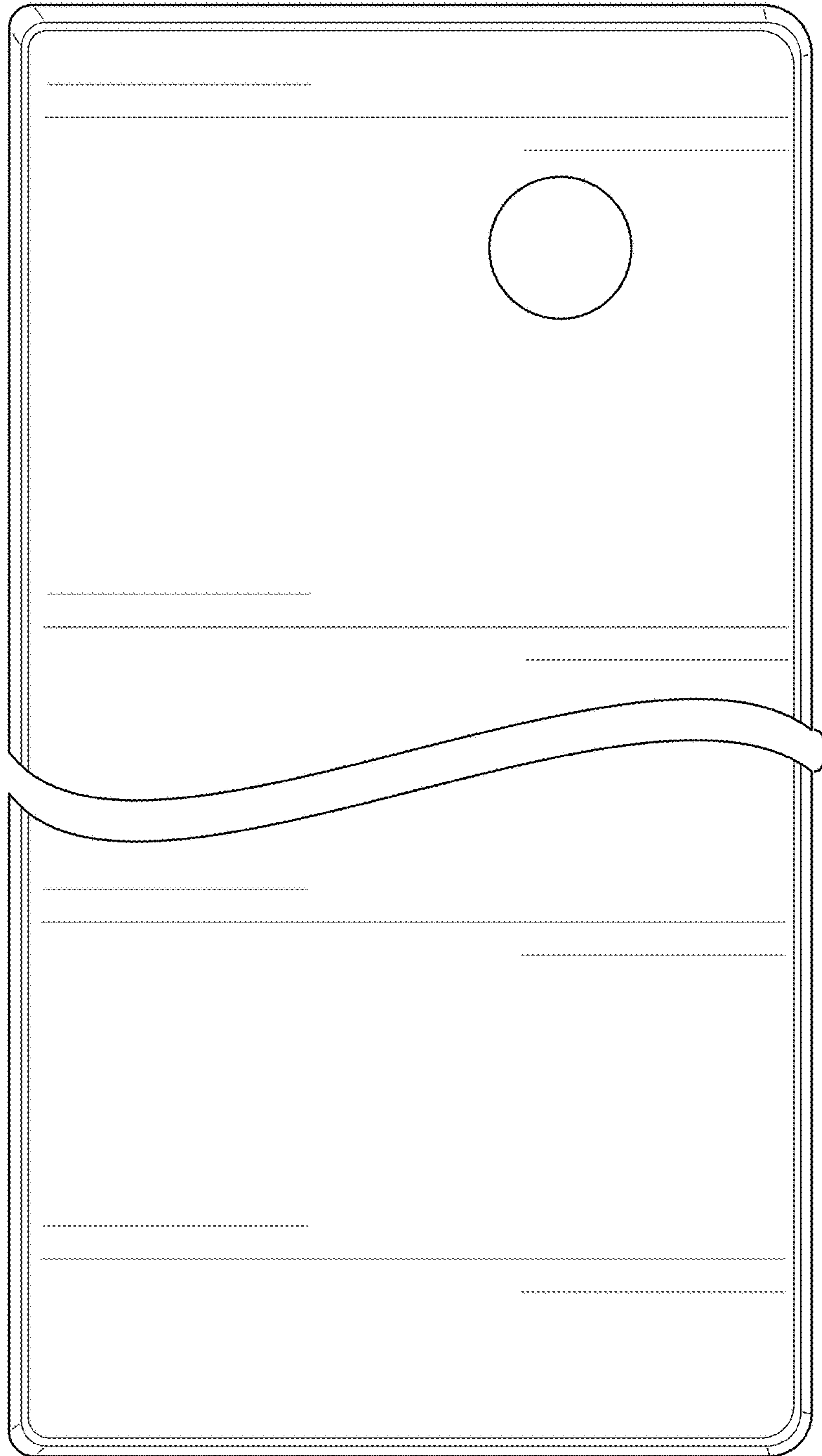

FIG. 7