



US00D858717S

(12) **United States Design Patent**
Chen

(10) **Patent No.:** **US D858,717 S**

(45) **Date of Patent:** **** Sep. 3, 2019**

(54) **FAUCET**

(71) Applicant: **Hui Chen**, Wenzhou (CN)

(72) Inventor: **Hui Chen**, Wenzhou (CN)

(**) Term: **15 Years**

(21) Appl. No.: **29/647,926**

(22) Filed: **May 16, 2018**

(51) **LOC (12) Cl.** **23-01**

(52) **U.S. Cl.**
USPC **D23/255**

(58) **Field of Classification Search**
USPC D23/238–243, 249, 255, 257
CPC E03C 1/04; E03C 1/0401; E03C 1/0402;
E03C 1/0404; Y10T 137/9464
See application file for complete search history.

(56) **References Cited**

U.S. PATENT DOCUMENTS

D678,985 S *	3/2013	Berger	D23/255
D680,195 S *	4/2013	Lord	D23/255
D680,622 S *	4/2013	Berger	D23/238
D718,427 S *	11/2014	Fritz	D23/257
D790,667 S *	6/2017	Schaubach	D23/252
D790,670 S *	6/2017	Downey	D23/255

OTHER PUBLICATIONS

Bathlavish Bathroom Sink Faucet Waterfall , Amazon, Date First Available May 2018, [Visited Online Mar. 21, 2019] https://www.amazon.com/Bathlavish-Waterfall-Commercial-Waterline-Lead-Free/dp/B07D3RKX9W/ref=sr_1_11?crid=2HKW3Q2WDTNOX&keywords=waterfall+faucet&qid=1553184503&s=hi&sprefix=waterf%2Ctools%2C178&sr=1-11.*

[amazon.com/Bathlavish-Waterfall-Commercial-Waterline-Lead-Free/dp/B07D3RKX9W/ref=sr_1_11?crid=2HKW3Q2WDTNOX&keywords=waterfall+faucet&qid=1553184503&s=hi&sprefix=waterf%2Ctools%2C178&sr=1-11.*](https://www.amazon.com/Bathlavish-Waterfall-Commercial-Waterline-Lead-Free/dp/B07D3RKX9W/ref=sr_1_11?crid=2HKW3Q2WDTNOX&keywords=waterfall+faucet&qid=1553184503&s=hi&sprefix=waterf%2Ctools%2C178&sr=1-11.*)

* cited by examiner

Primary Examiner — Eric L Goodman

Assistant Examiner — Amy C Wierenga

(74) *Attorney, Agent, or Firm* — Raymond Y. Chan;

David and Raymond Patent Firm

(57) **CLAIM**

The ornamental design for a faucet, as shown and described.

DESCRIPTION

FIG. 1 is a perspective view of the faucet showing my new design;

FIG. 2 is a right view thereof;

FIG. 3 is a left view thereof;

FIG. 4 is a front view thereof;

FIG. 5 is a rear view thereof;

FIG. 6 is a top perspective view thereof; and,

FIG. 7 is a bottom perspective view thereof.

The broken lines represent unclaimed portions of the design article. All of the broken lines forms no part of the claimed design.

1 Claim, 7 Drawing Sheets

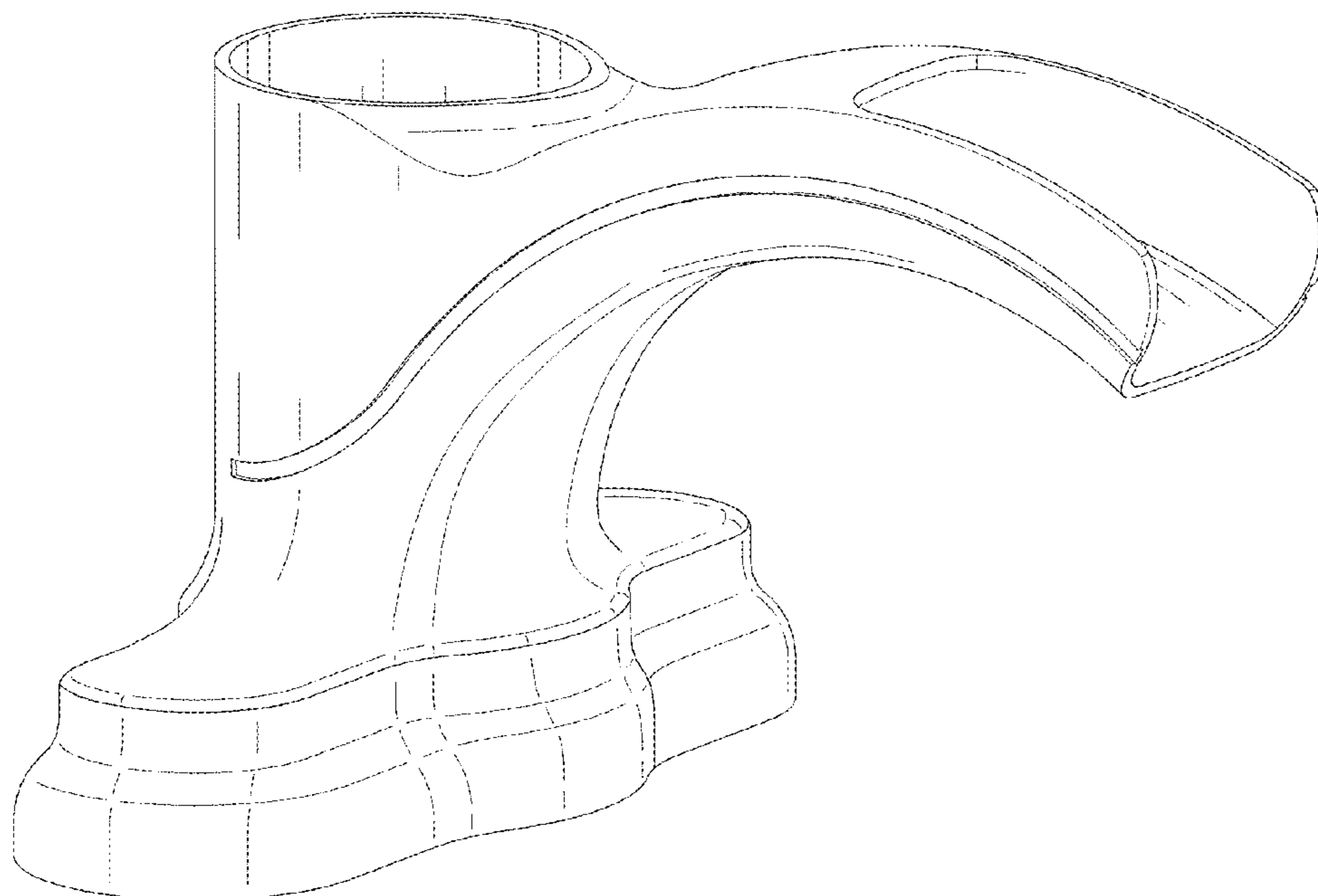

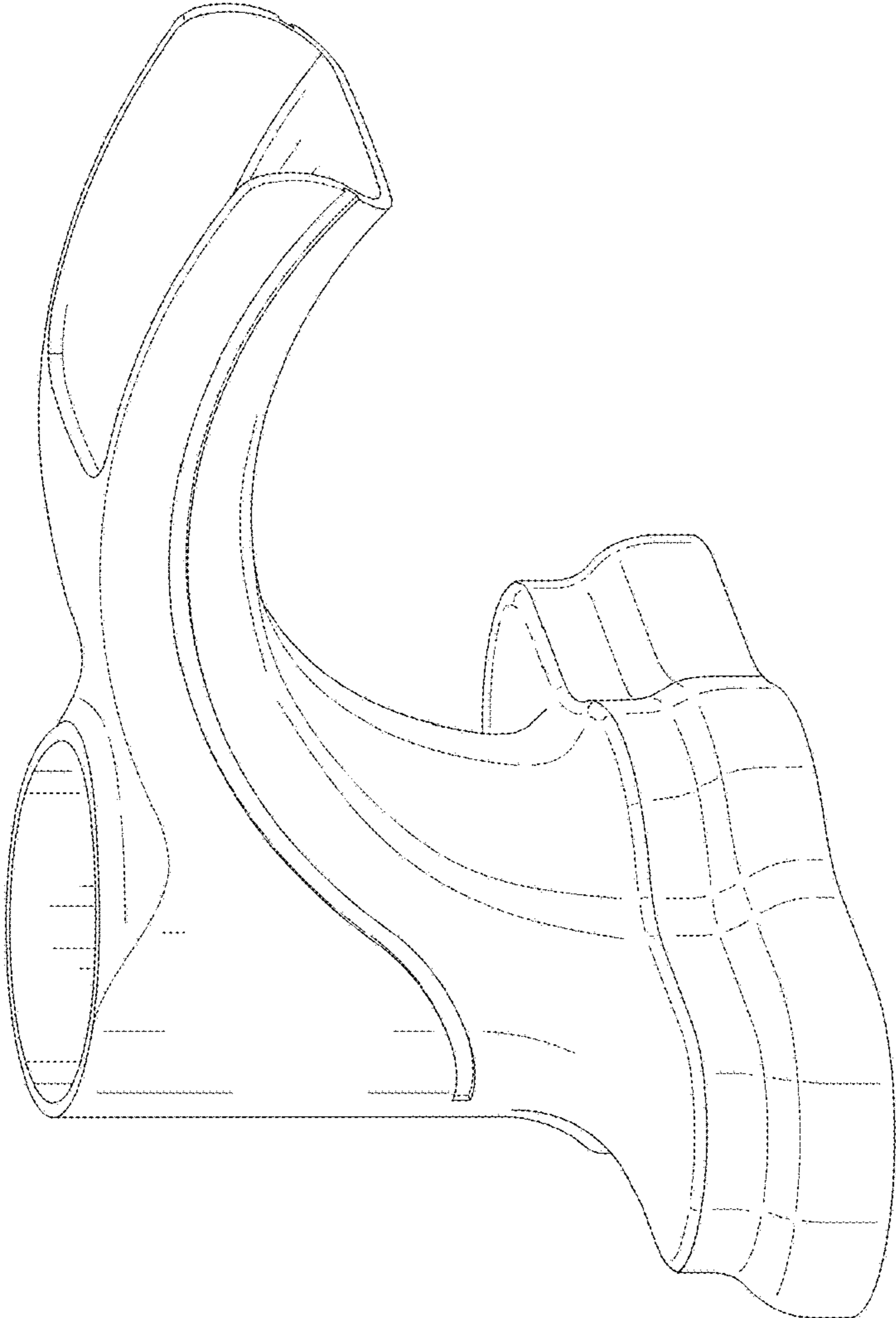

FIG. 1

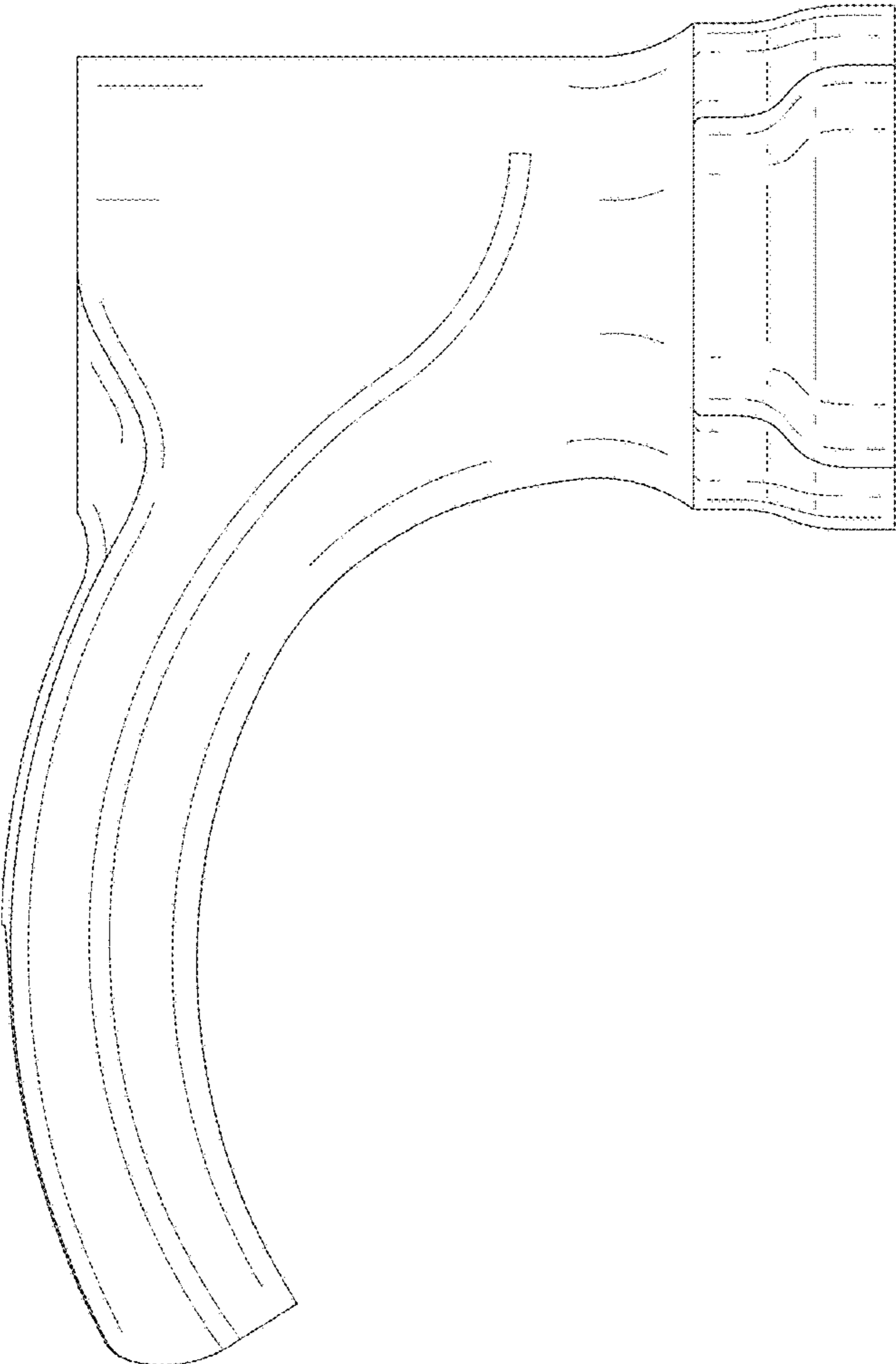

FIG. 2

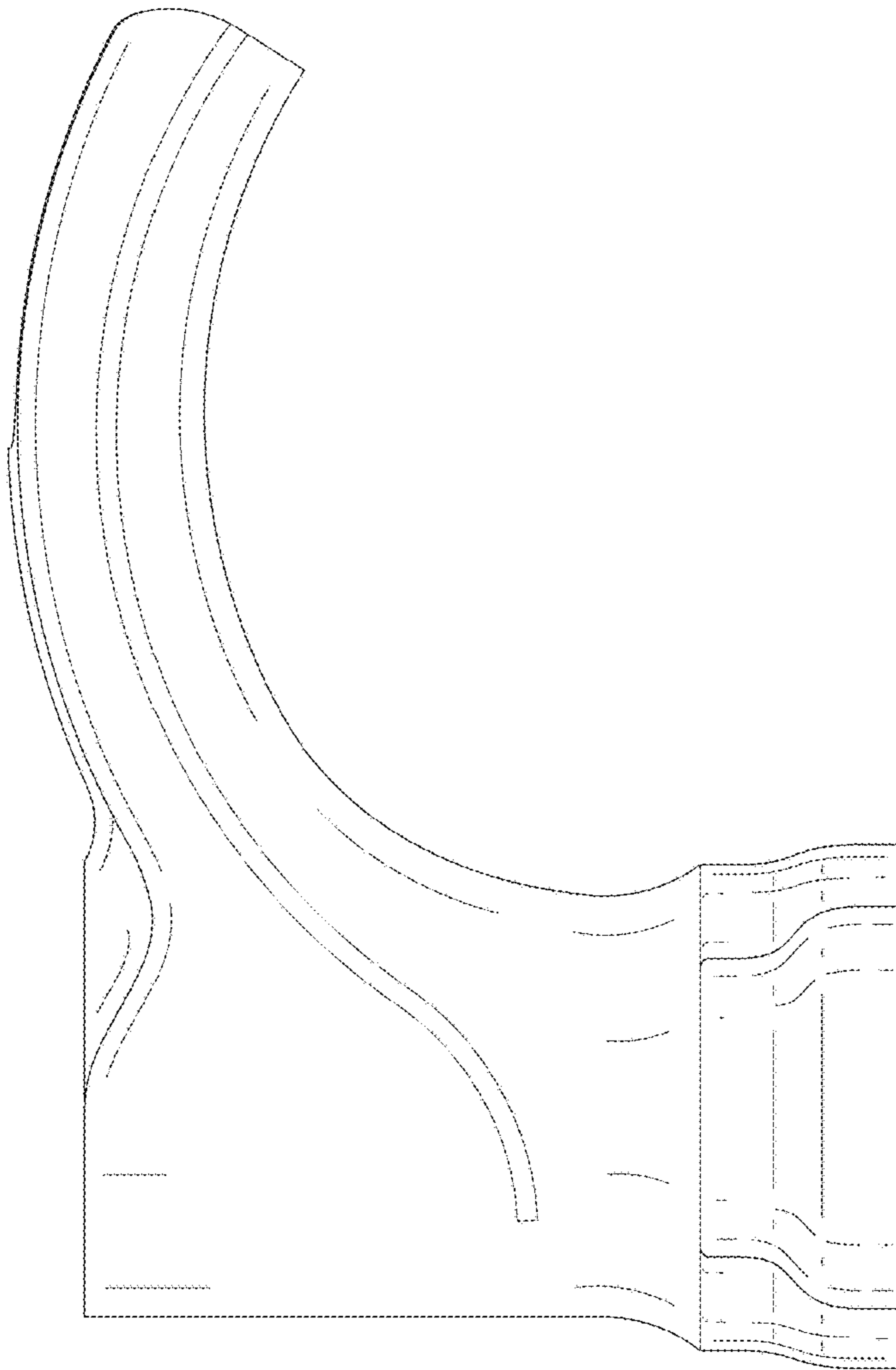

FIG. 3

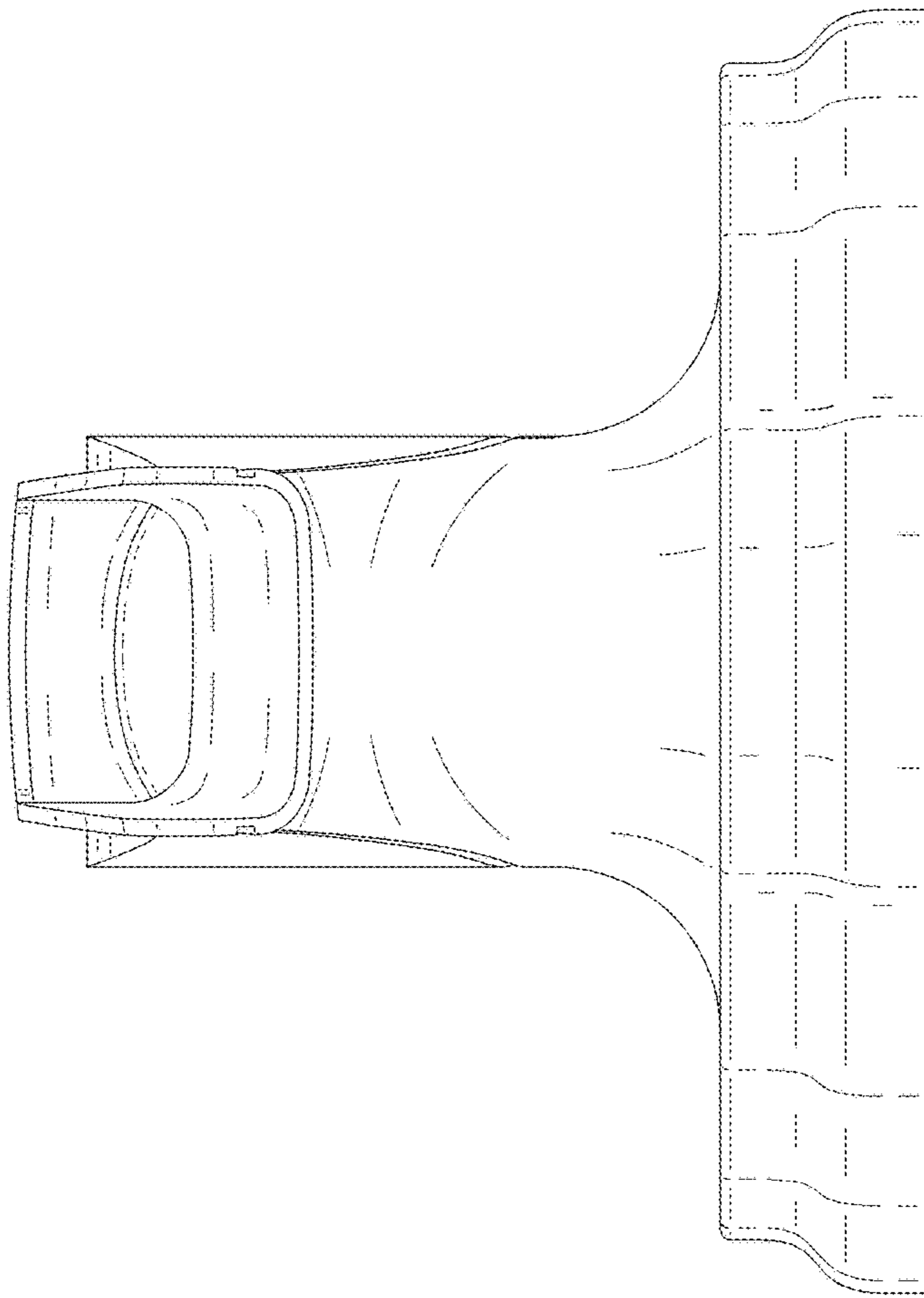

FIG. 4

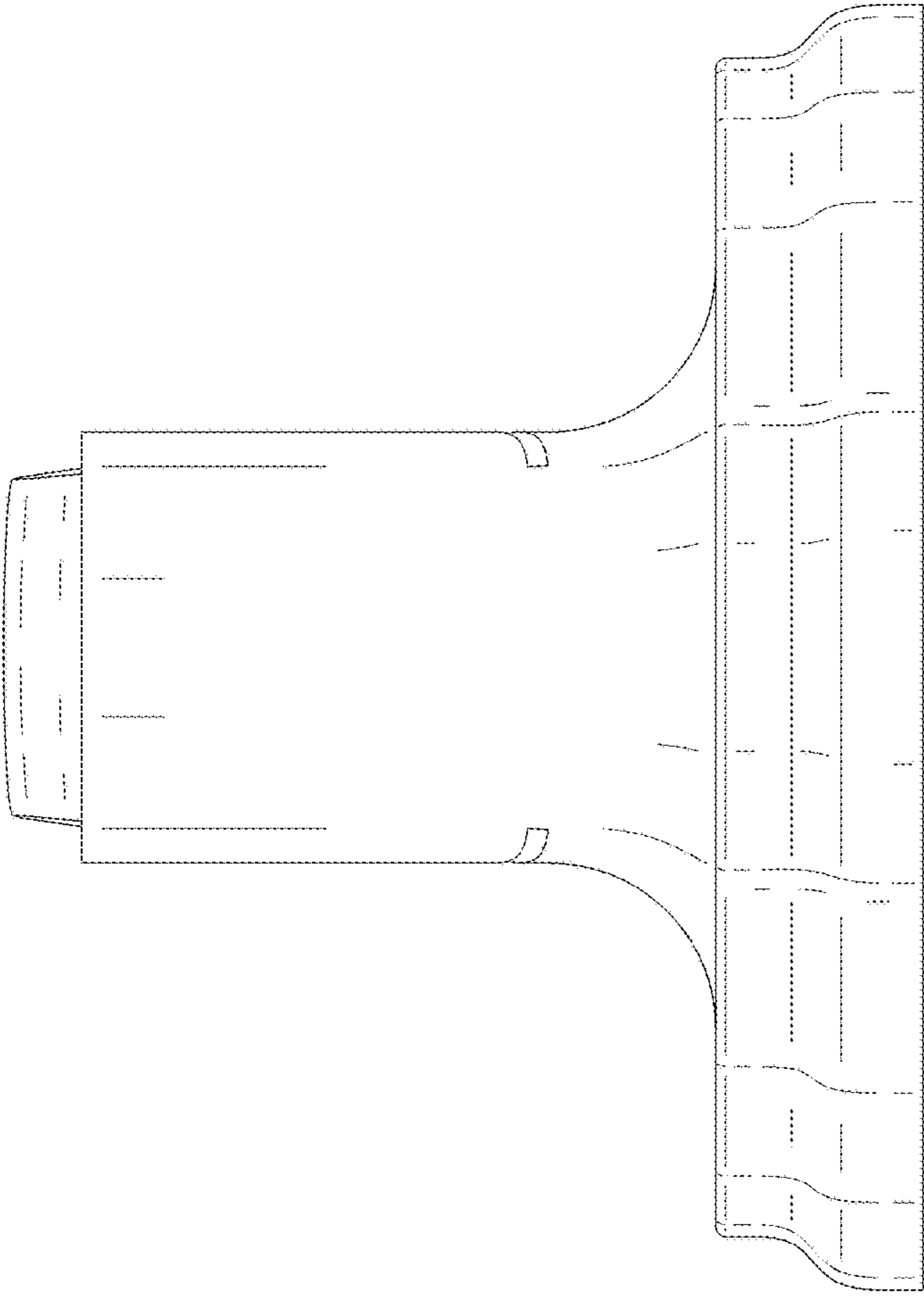

FIG. 5

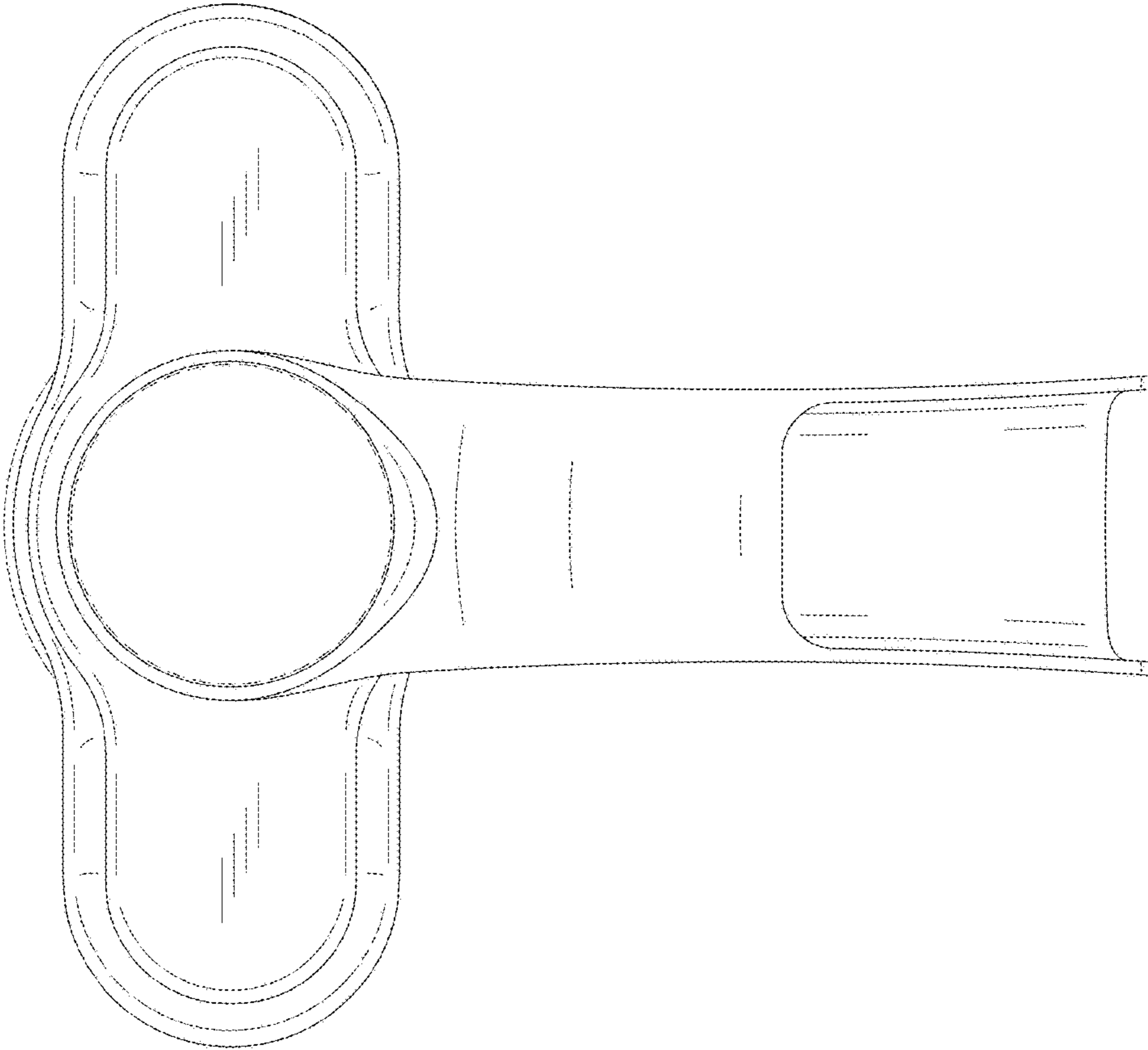

FIG. 6

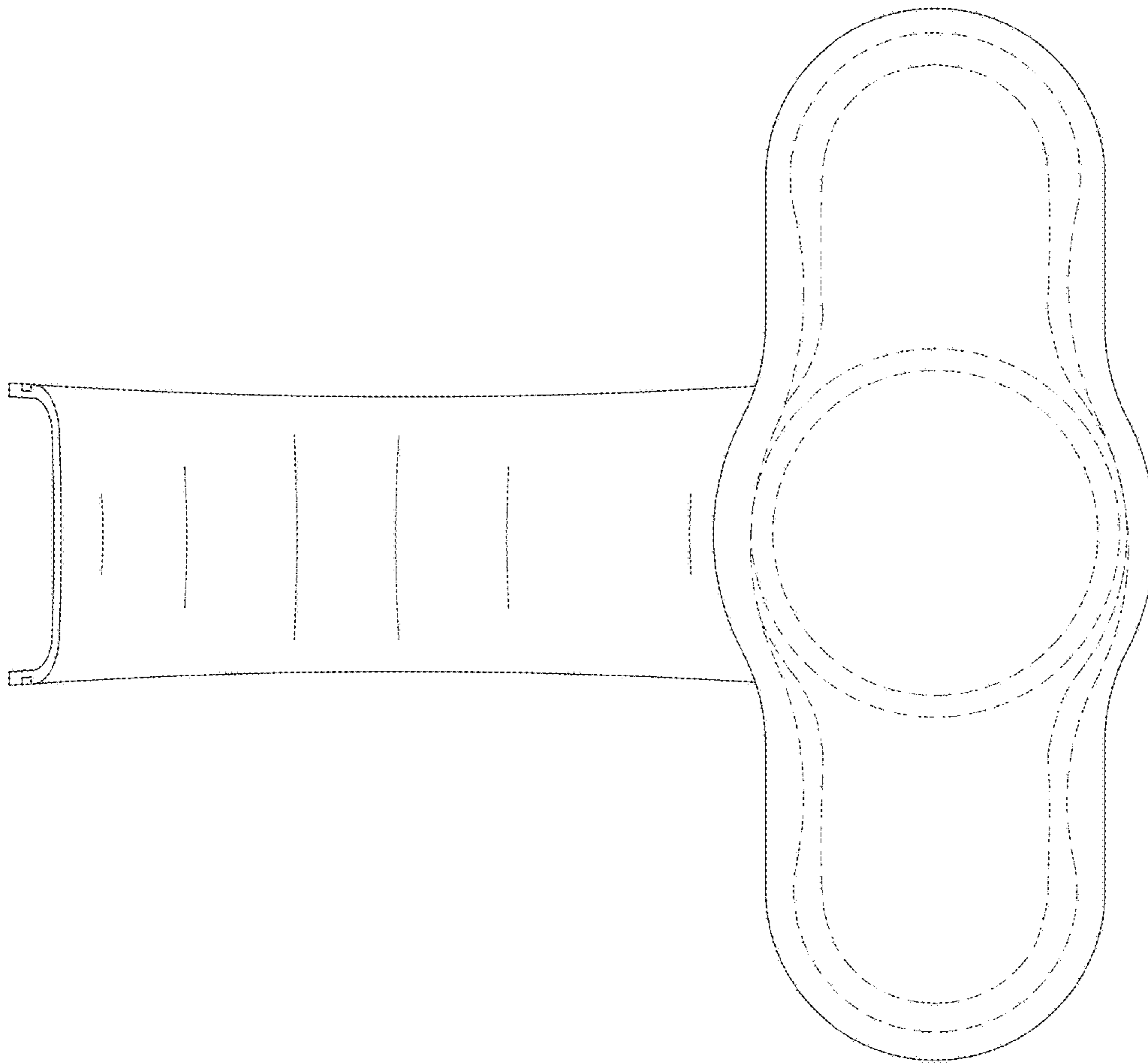

FIG. 7