



US00D858707S

(12) **United States Design Patent** (10) **Patent No.:** **US D858,707 S**
Soulier et al. (45) **Date of Patent:** **** Sep. 3, 2019**

(54) **TUB FILLER**

(71) Applicant: **Kohler Co.**, Kohler, WI (US)

(72) Inventors: **Jean-Hugues Soulier**, Paris (FR);
Ferran Serra Sola, Paris (FR); **Chia Lee**, Chicago, IL (US); **Jimin Niu**, Beijing (CN); **Sophie Su**, Shanghai (CN); **Hui Ren**, Beijing (CN)

(73) Assignee: **KOHLER CO.**, Kohler, WI (US)

(**) Term: **15 Years**

(21) Appl. No.: **29/644,542**

(22) Filed: **Apr. 18, 2018**

(51) **LOC (12) Cl.** **23-01**

(52) **U.S. Cl.**
USPC **D23/238**

(58) **Field of Classification Search**
USPC D23/238, 239-243, 249, 255, 257
See application file for complete search history.

(56) **References Cited**

U.S. PATENT DOCUMENTS

D514,199 S *	1/2006	Starck	D23/238
D529,136 S *	9/2006	Smith	D23/238
D529,580 S	10/2006	Shieh		
D583,907 S	12/2008	Citterio		
D612,458 S *	3/2010	Allard	D23/255
D615,623 S *	5/2010	Krause	D23/239
D616,069 S *	5/2010	Krause	D23/239
D635,647 S *	4/2011	Montgomery	D23/239
D636,062 S	4/2011	Rubin et al.		
D681,168 S *	4/2013	Romero	D23/238
D697,589 S	1/2014	Georgeson		

D698,420 S	1/2014	Hahn et al.
D713,009 S	9/2014	Citterio
D734,836 S	7/2015	Flowers
D755,350 S	5/2016	Rexach
D757,229 S	5/2016	Garland
D759,206 S	6/2016	Moerman
D771,776 S	11/2016	Schoenherr
D790,664 S	6/2017	Eads
D790,665 S	6/2017	Spangler
D790,666 S	6/2017	Lord

* cited by examiner

Primary Examiner — Eric L Goodman

Assistant Examiner — Amy C Wierenga

(74) *Attorney, Agent, or Firm* — Foley & Lardner LLP

(57) **CLAIM**

We claim the ornamental design for a tub filler, as shown and described.

DESCRIPTION

FIG. 1 is a top, front, right perspective view of a tub filler; FIG. 2 is a front elevation view thereof; FIG. 3 is a rear elevation view thereof; FIG. 4 is a right side elevation view thereof; FIG. 5 is a left side elevation view thereof; FIG. 6 is a top plan view thereof; and, FIG. 7 is a bottom plan view thereof. The broken lines shown in the drawings illustrate portions of the tub filler that form no part of the claim. The tub filler is shown with a symbolic break in its length. The appearance of any portion of the article between the break lines forms no part of the claim.

1 Claim, 4 Drawing Sheets

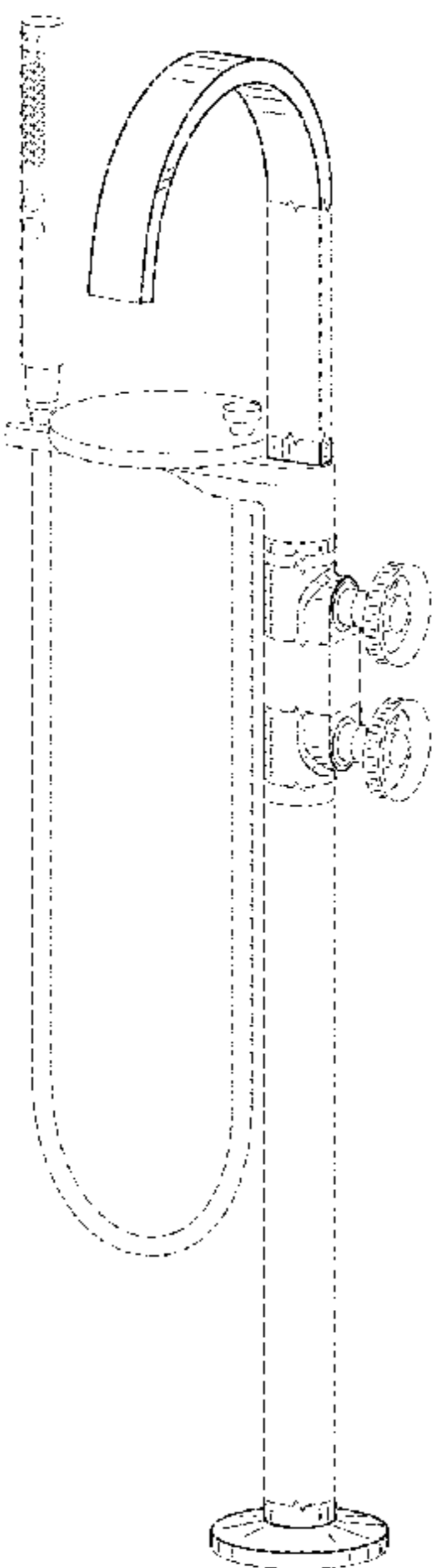

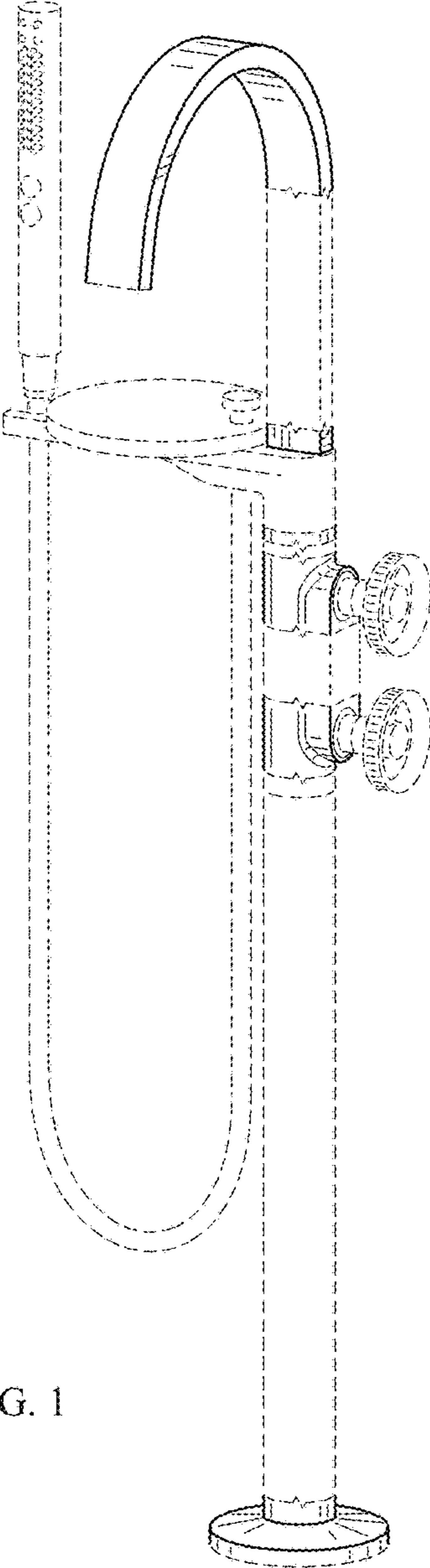

FIG. 1

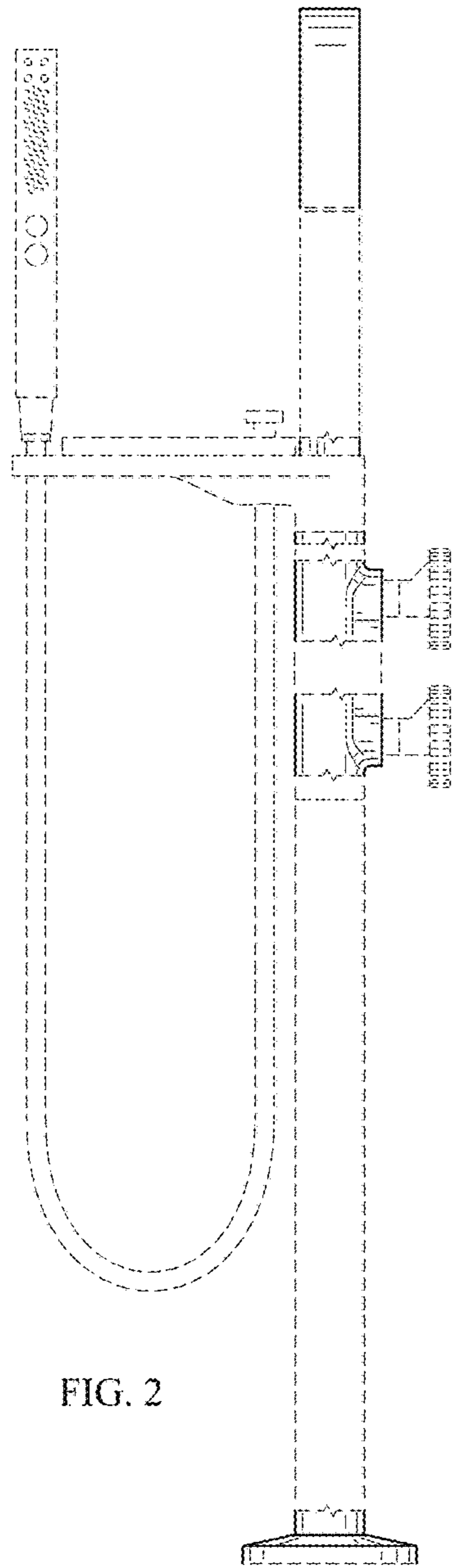

FIG. 2

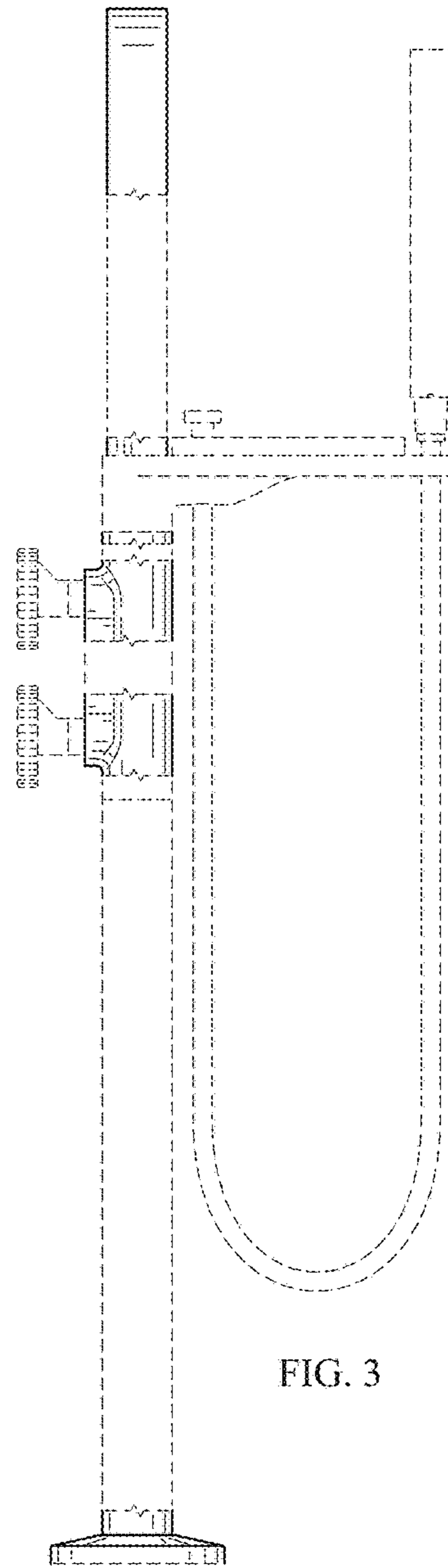

FIG. 3

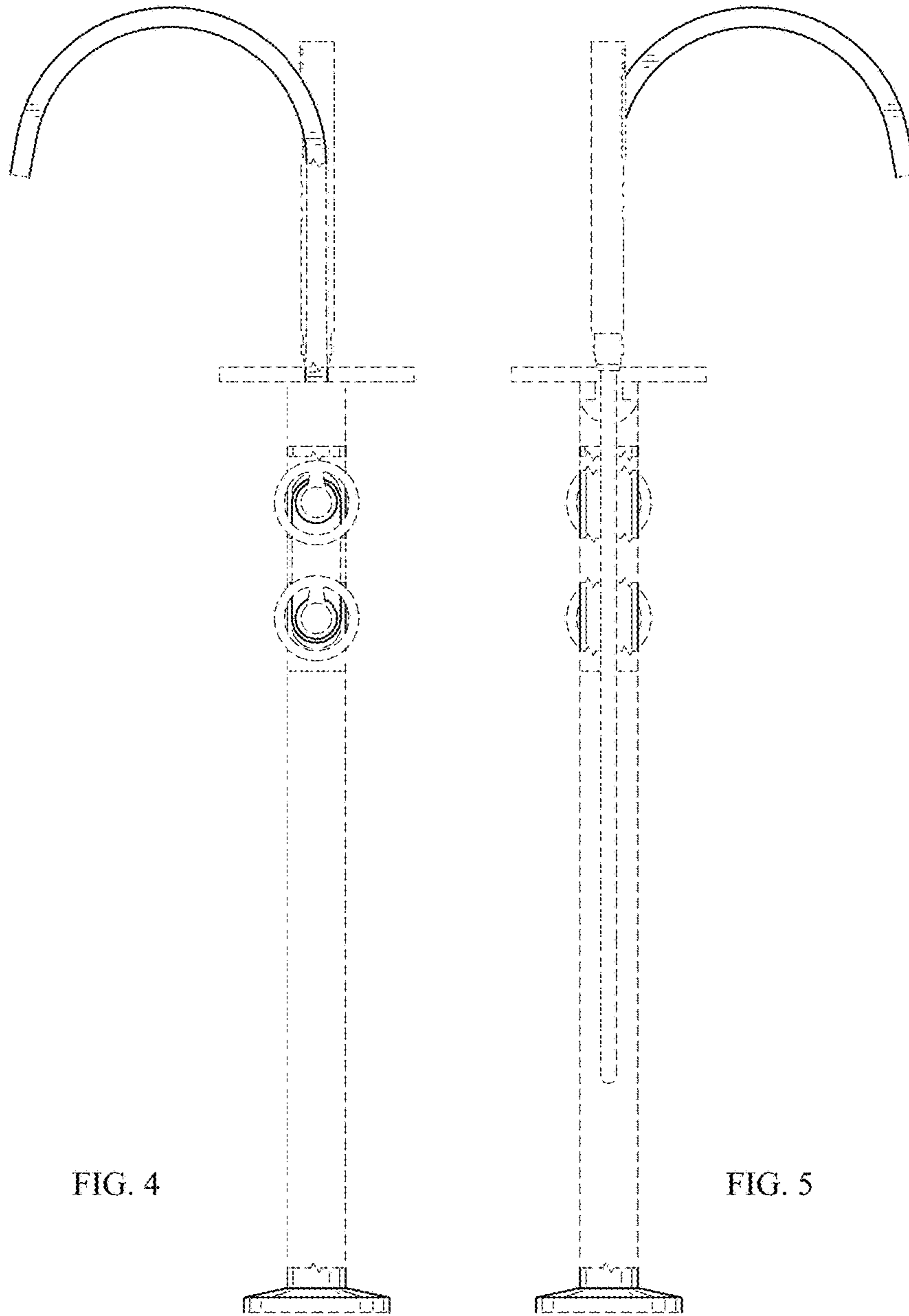

FIG. 4

FIG. 5

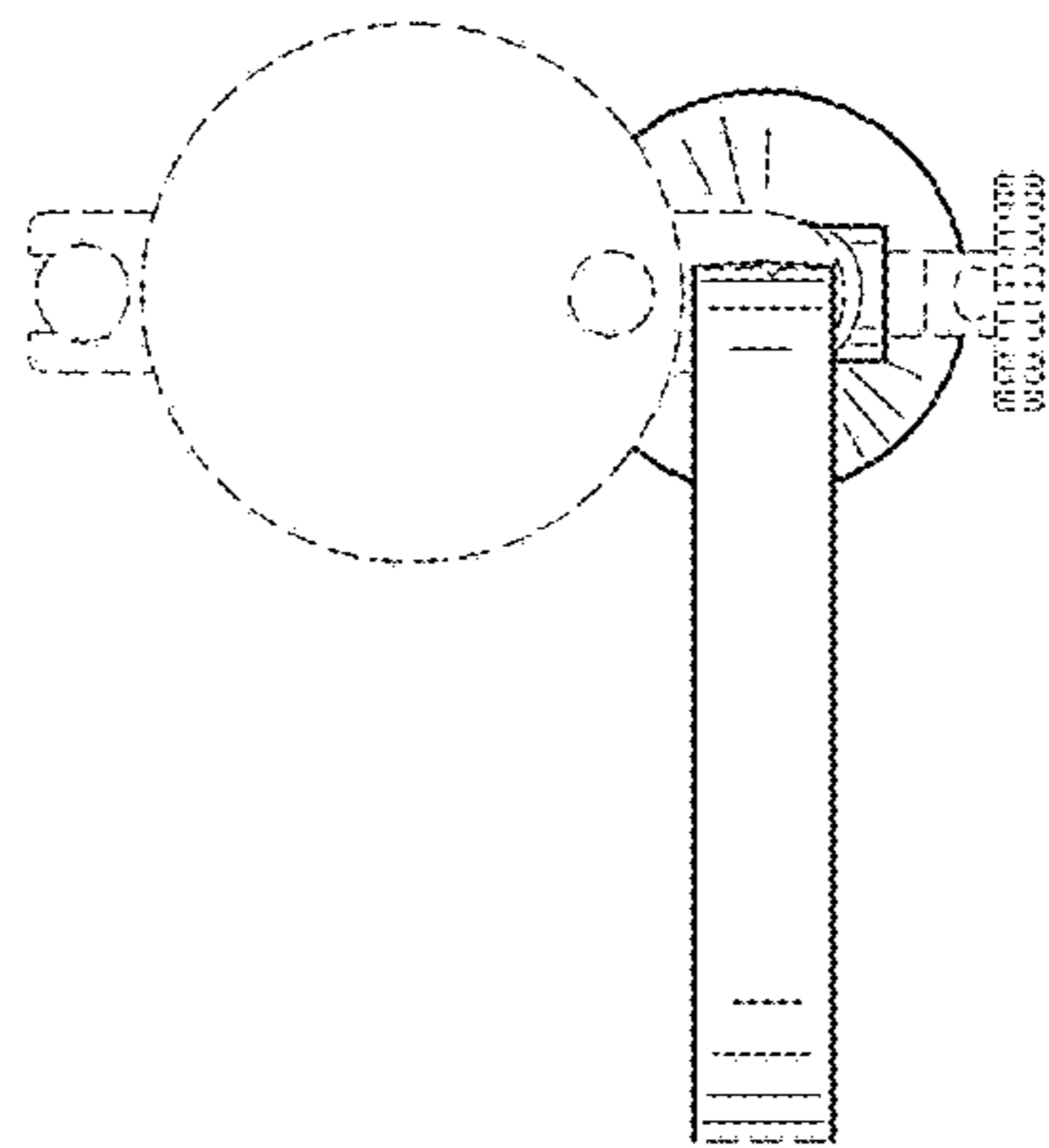

FIG. 6

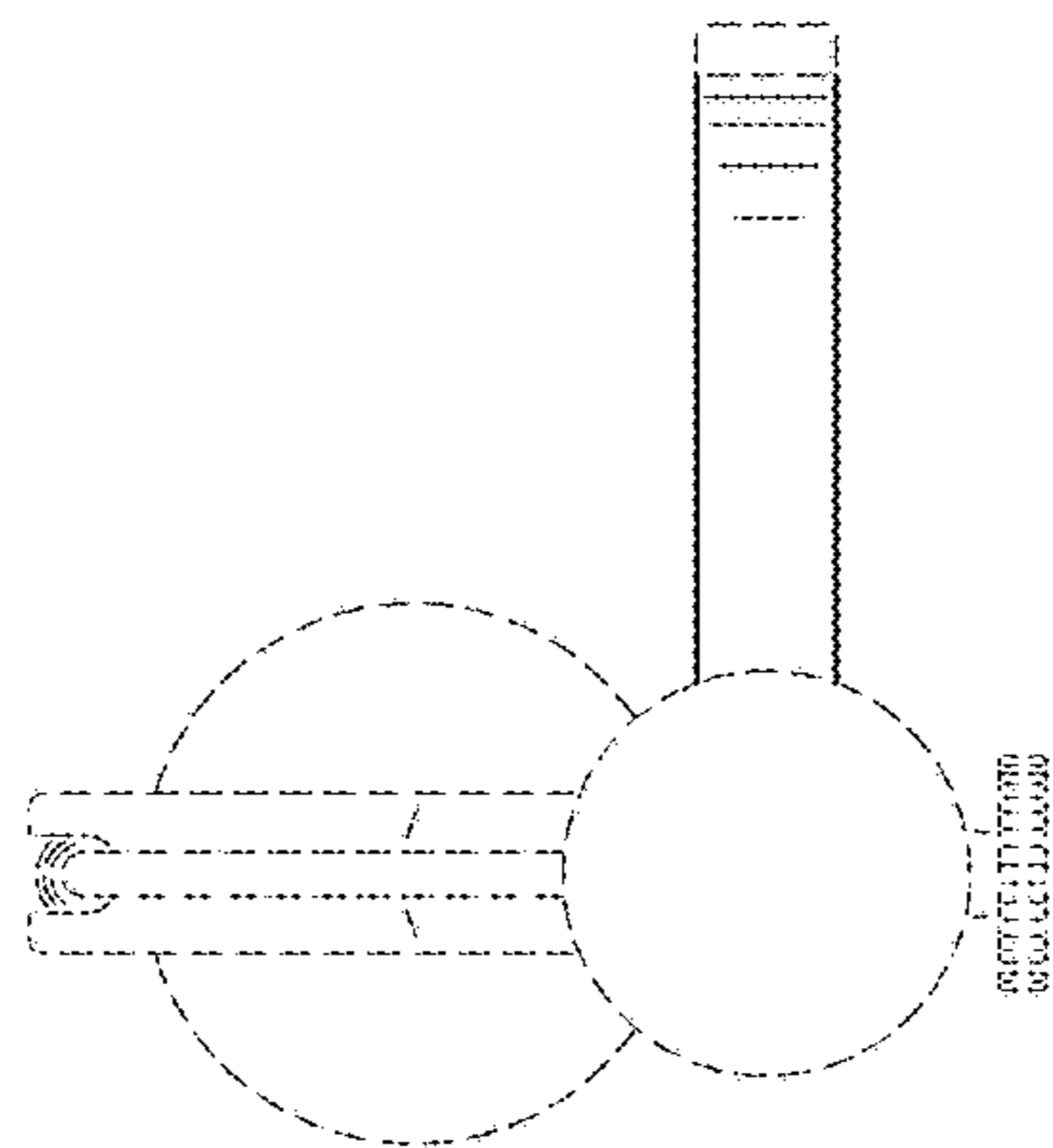

FIG. 7