



US00D858691S

(12) **United States Design Patent**
Zou

(10) **Patent No.:** **US D858,691 S**
(45) **Date of Patent:** **** Sep. 3, 2019**

- (54) **FILTER UNIT**
- (71) Applicant: **Qingdao Ecopure Filter Co., Ltd,**
Qingdao (CN)
- (72) Inventor: **Zhibin Zou,** Qingdao (CN)
- (73) Assignee: **QINGDAO ECOPURE FILTER CO., LTD,**
Qingdao (CN)

6,257,417 B1 * 7/2001 Szumera B01D 35/30
210/443
7,387,726 B2 * 6/2008 Wolf B01D 29/055
210/232
8,216,463 B1 * 7/2012 Baird B01D 35/30
210/232
9,555,347 B2 * 1/2017 Tucker B01D 29/111
D798,997 S * 10/2017 Zou D23/209

* cited by examiner

(**) Term: **15 Years**

Primary Examiner — Robin V Webster

(21) Appl. No.: **29/641,476**

(74) *Attorney, Agent, or Firm* — Muncy, Geissler, Olds & Lowe, P.C.

(22) Filed: **Mar. 22, 2018**

(57) **CLAIM**

(51) **LOC (12) Cl.** **23-01**

The ornamental design for a filter unit, as shown and described.

(52) **U.S. Cl.**
USPC **D23/209**

DESCRIPTION

(58) **Field of Classification Search**
USPC D23/207, 209; 215/384; D7/316, 318,
D7/319, 397, 612, 629
CPC B01D 35/30; B01D 35/153; B01D 29/111;
B01D 29/58; C02F 1/003; B65D 23/102
See application file for complete search history.

FIG. 1 is a Front elevational view of a filter unit showing my new design;
FIG. 2 is a Rear elevational view thereof;
FIG. 3 is a Left side view thereof;
FIG. 4 is a Right side view thereof;
FIG. 5 is a Top plan view thereof;
FIG. 6 is a Bottom plan view thereof; and,
FIG. 7 is a Perspective views thereof.

(56) **References Cited**

U.S. PATENT DOCUMENTS

- 3,912,633 A * 10/1975 Delaney B01D 27/08
210/167.02
- D346,640 S * 5/1994 Kim B01D 35/30
D23/209

The broken lines in the drawing depict portions of the filter unit that form no part of the claimed design.

1 Claim, 7 Drawing Sheets

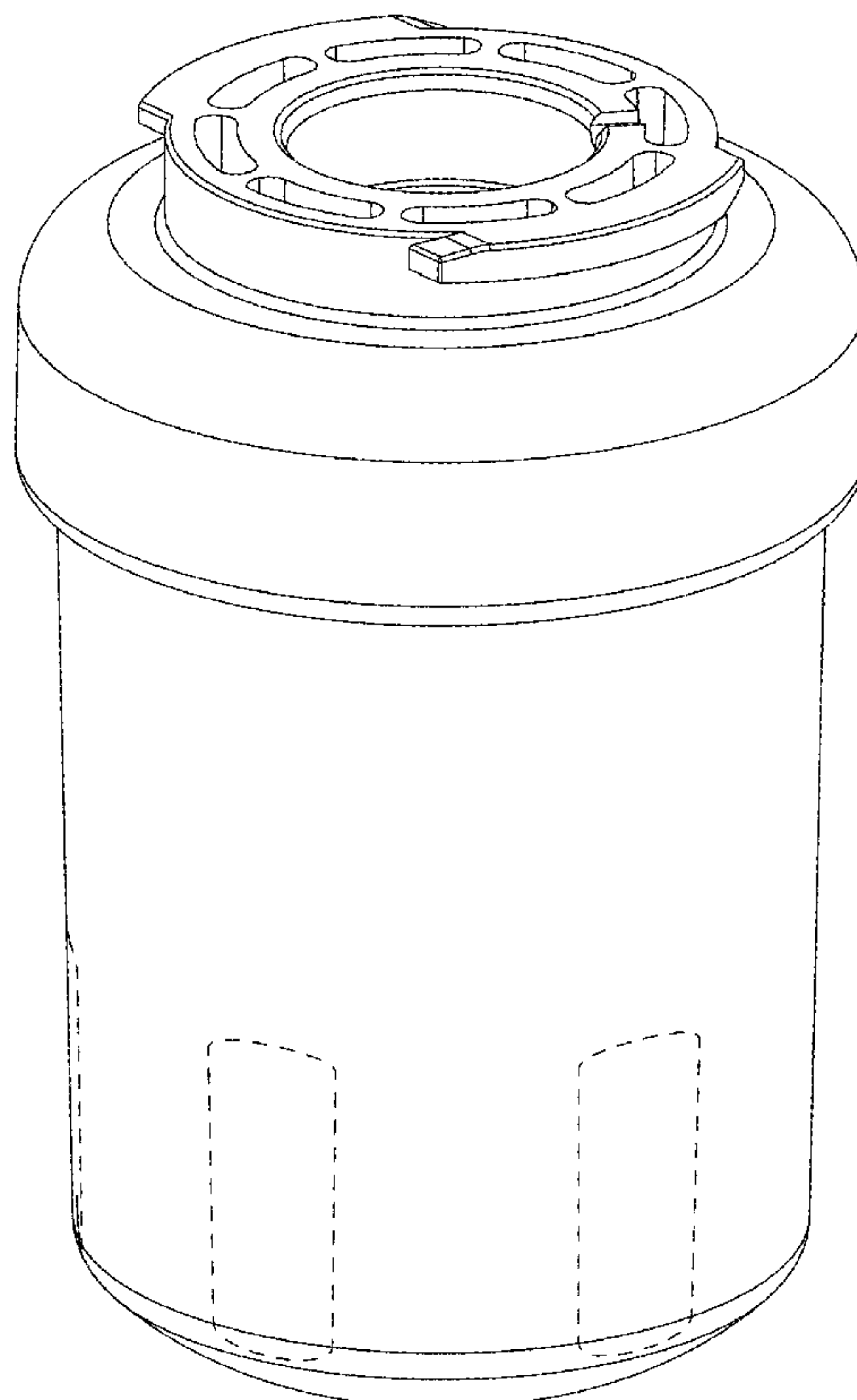

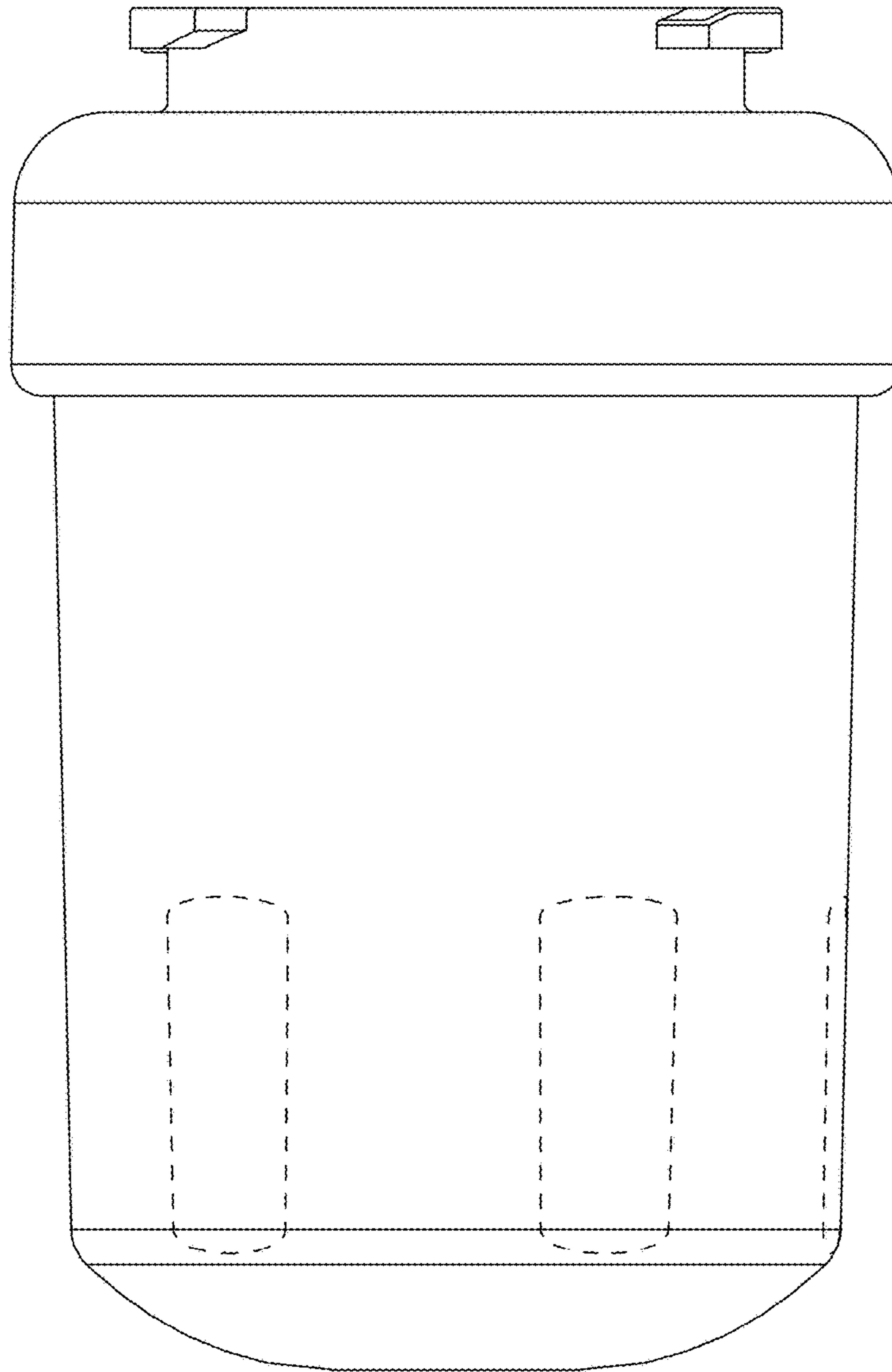

FIG. 1

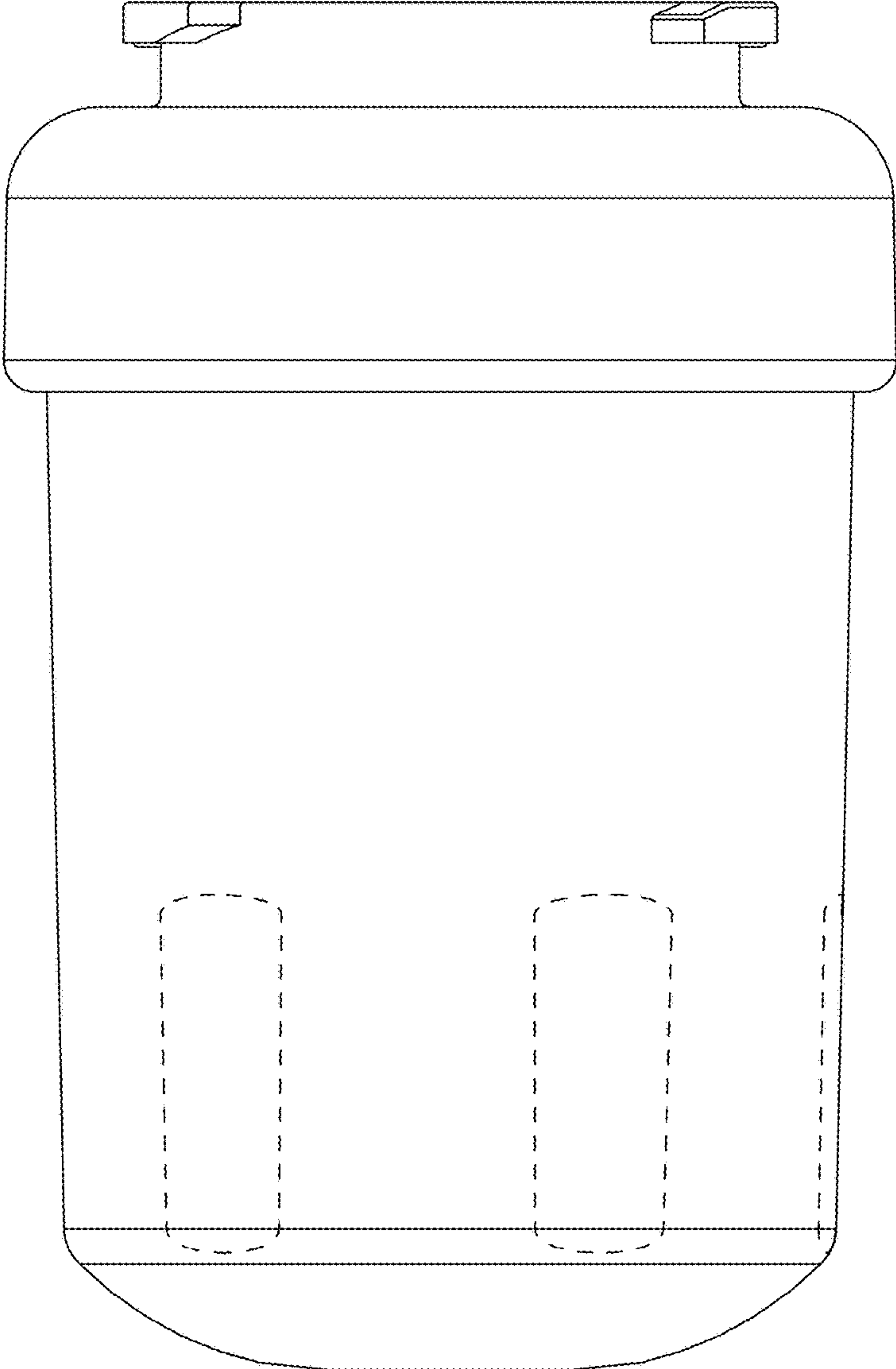

FIG. 2

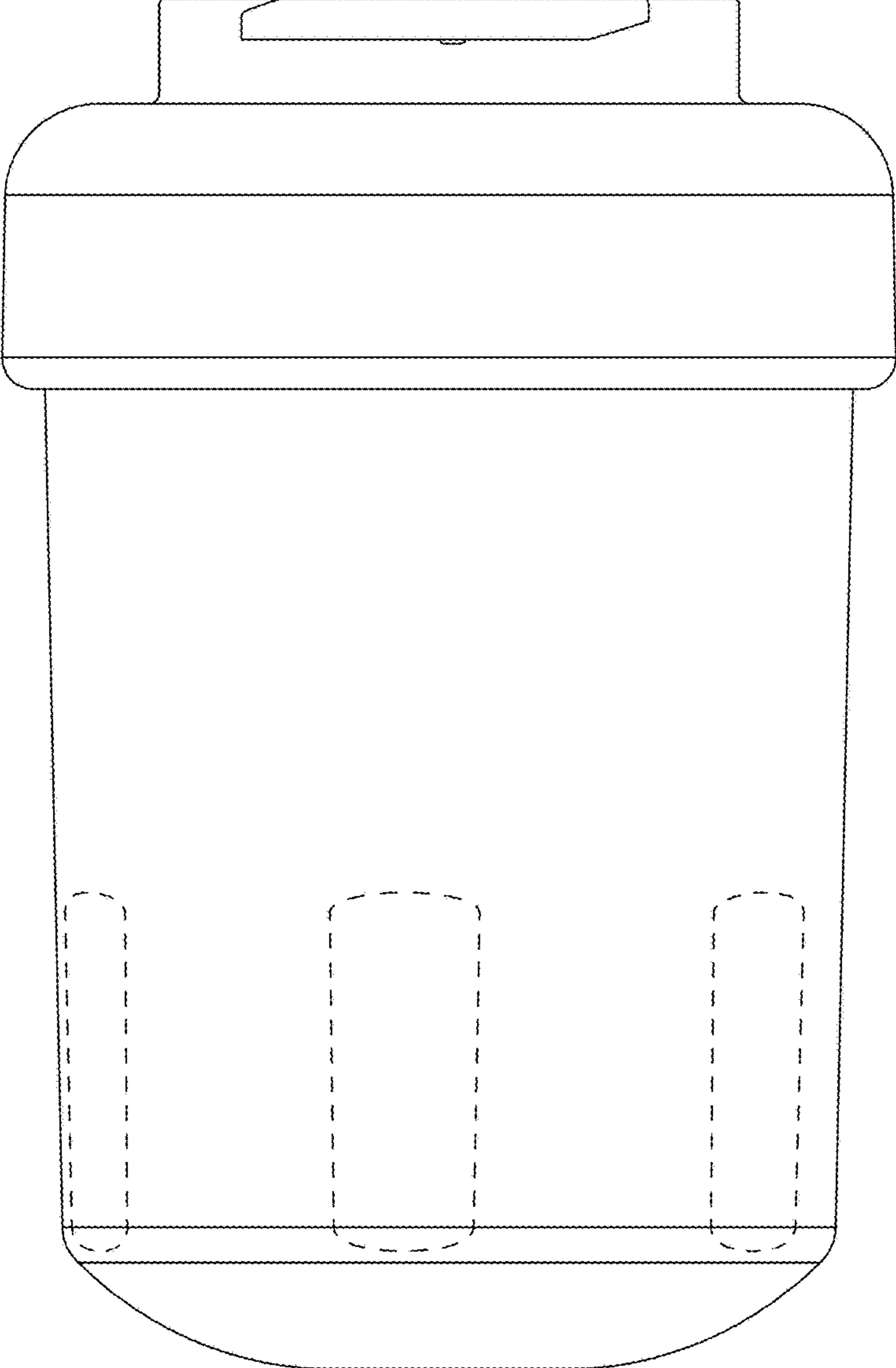

FIG. 3

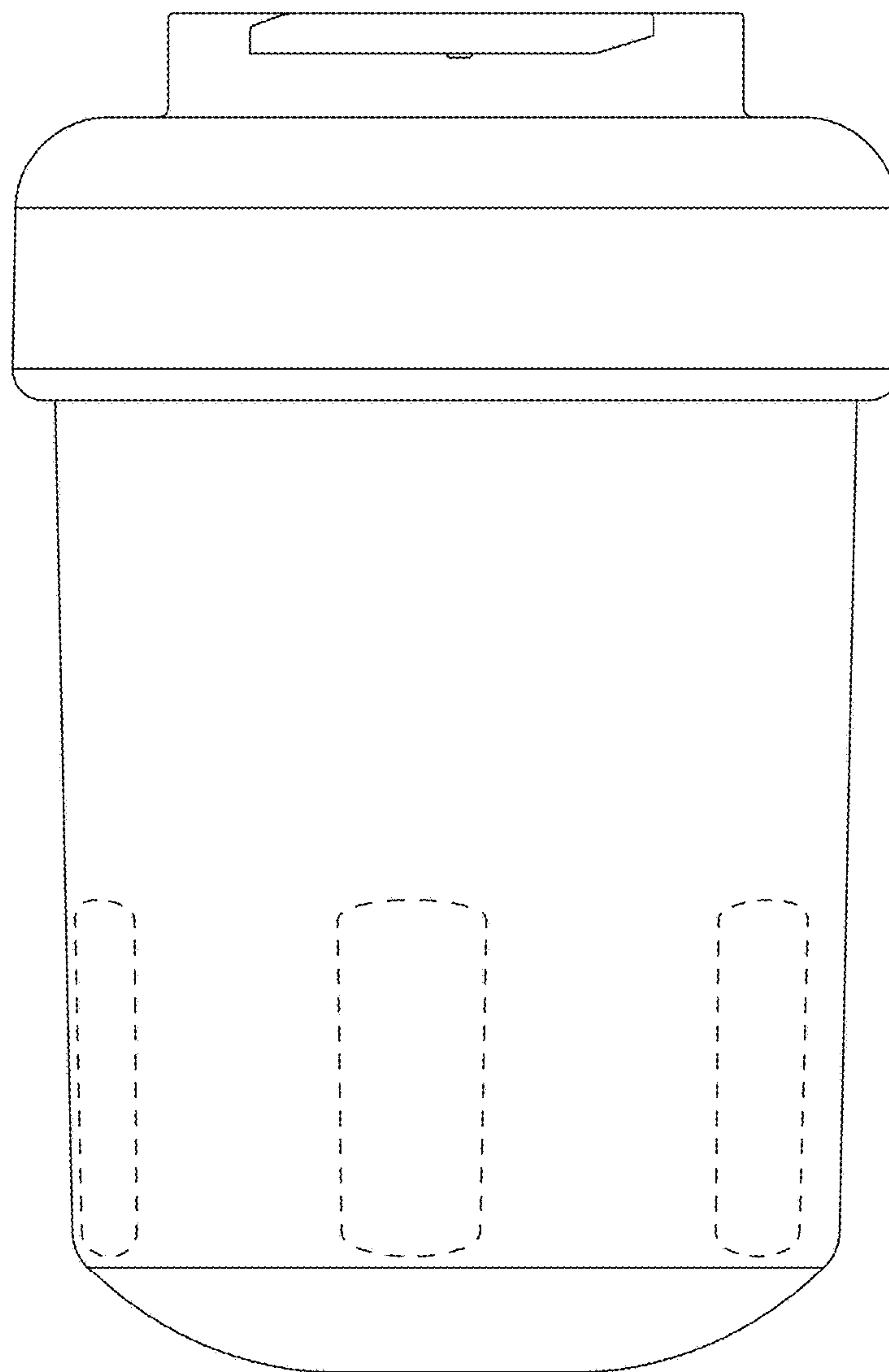

FIG. 4

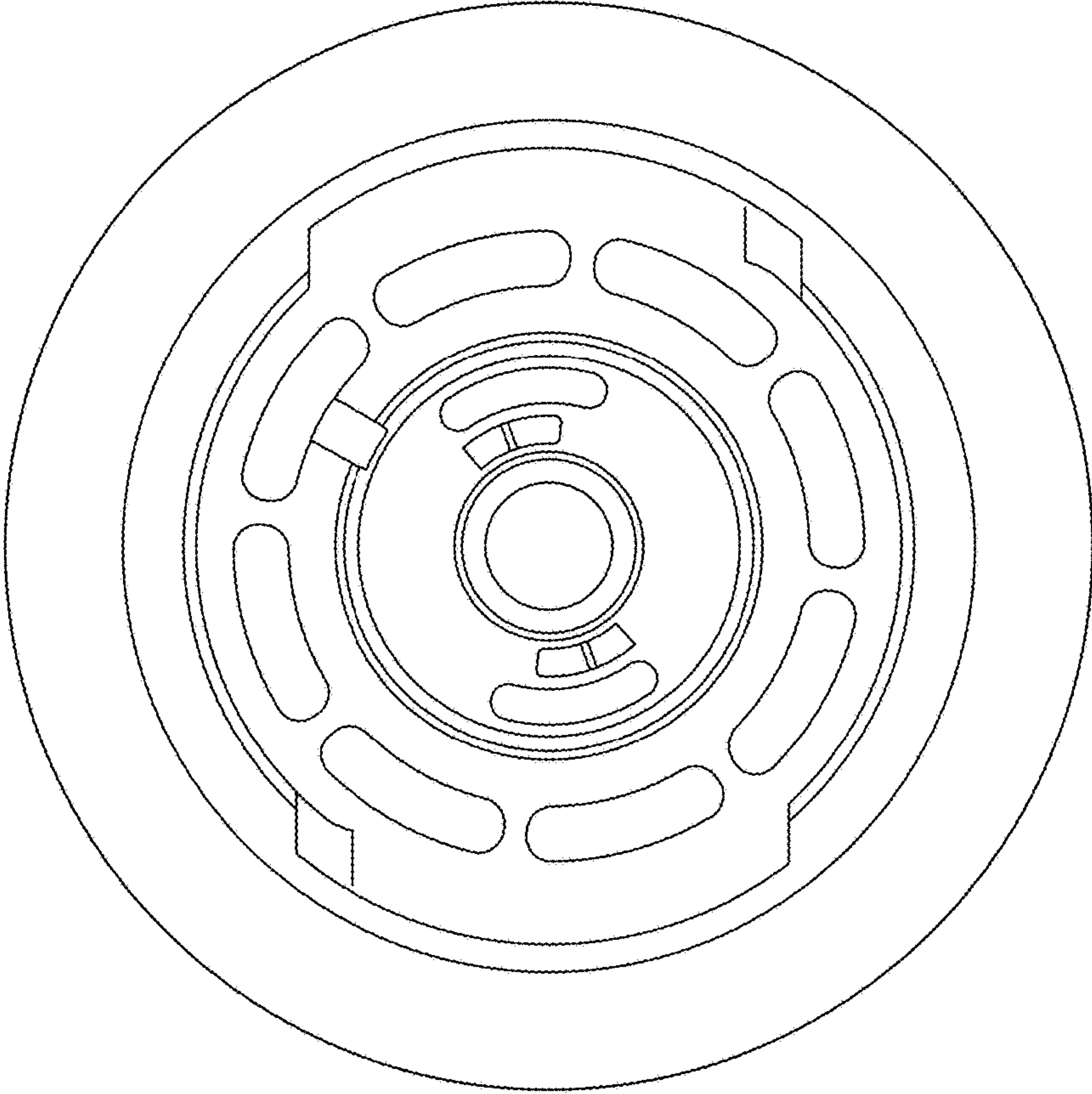

FIG. 5

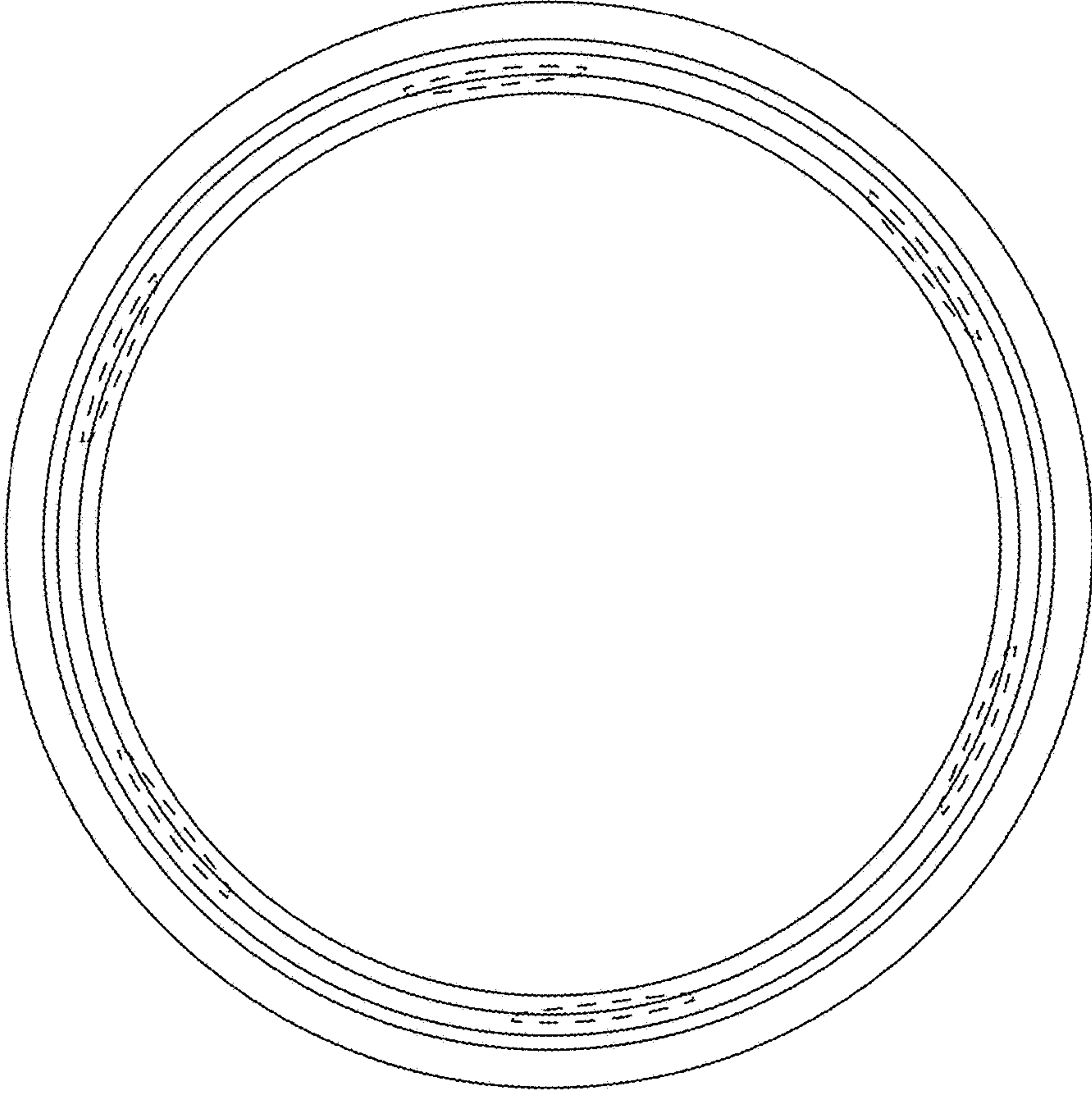

FIG. 6

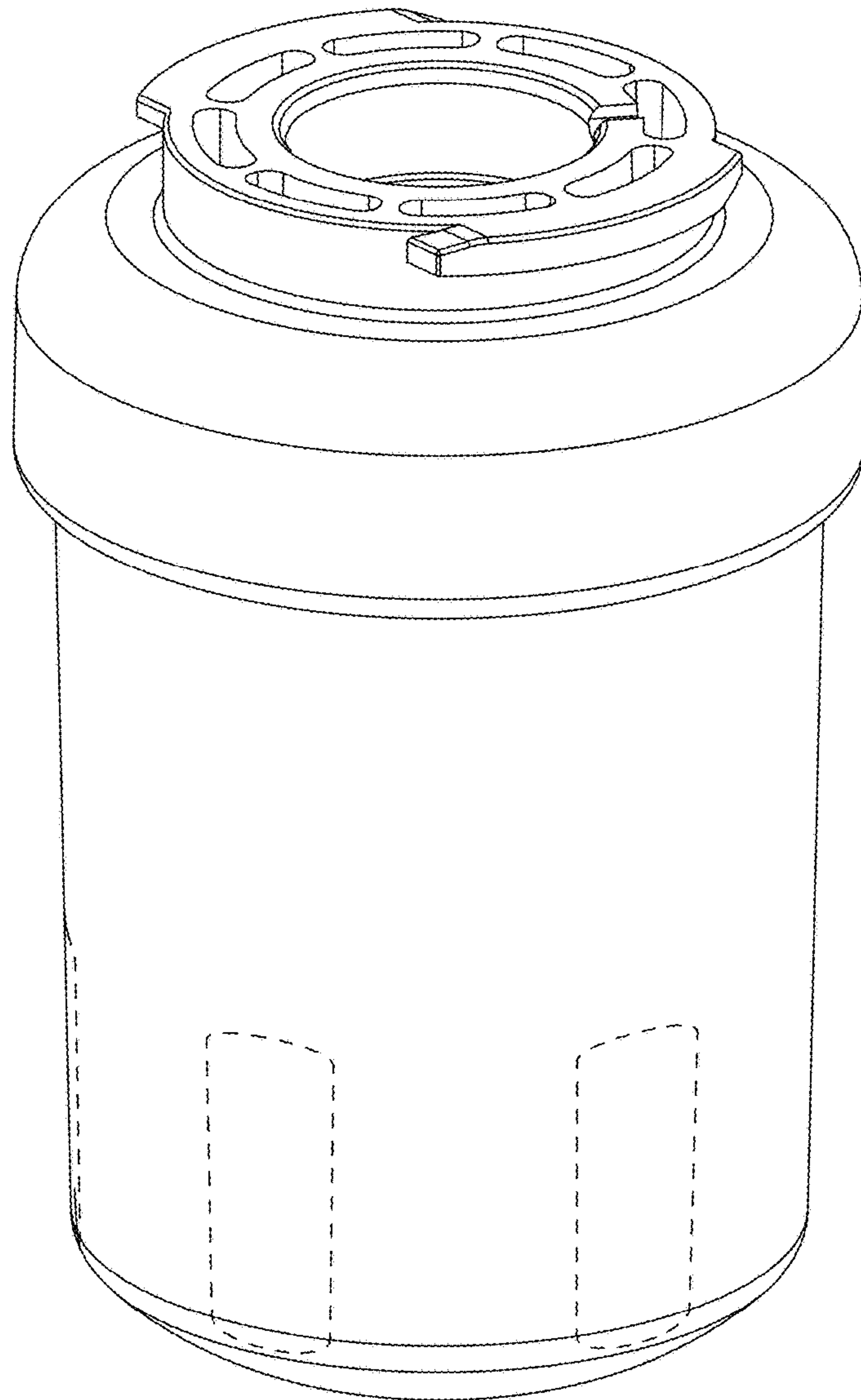

FIG. 7