



US00D858525S

(12) **United States Design Patent** (10) **Patent No.:** **US D858,525 S**  
**Sittig** (45) **Date of Patent:** **\*\* Sep. 3, 2019**

(54) **BARCODE SCANNER**

(71) Applicant: **WORKAROUND GMBH**, München (DE)

(72) Inventor: **Hans Christian Sittig**, Freiburg (DE)

(73) Assignee: **WORKAROUND GMBH** (DE)

(\*\*) Term: **15 Years**

(21) Appl. No.: **35/502,375**

(22) Filed: **Nov. 15, 2016**

(80) **Hague Agreement Data**

Int. Filing Date: **Nov. 15, 2016**

Int. Reg. No.: **DM/094333**

Int. Reg. Date: **Nov. 15, 2016**

Int. Reg. Pub. Date: **Feb. 3, 2017**

(51) **LOC (12) Cl.** ..... **14-02**

(52) **U.S. Cl.**  
USPC ..... **D14/427**

(58) **Field of Classification Search**  
USPC ..... D14/420, 427, 453, 412, 507, 371, 248,  
D14/341, 203.1, 203.3, 203.7, 250,  
D14/315-318, 388-389; D10/50;  
D13/107, 184

CPC ..... G06K 7/10891; G06K 7/10881; G06K  
7/10534; G06K 7/10584; G06K 7/10564

See application file for complete search history.

(56) **References Cited**

**U.S. PATENT DOCUMENTS**

- D335,661 S \* 5/1993 Shepard ..... D14/427
- D342,245 S \* 12/1993 Krichever ..... D14/427
- 5,340,972 A \* 8/1994 Sandor ..... G06K 7/10564  
235/462.44
- D372,234 S \* 7/1996 LaManna ..... D14/427
- D377,348 S \* 1/1997 Karlin ..... 14/2
- 5,602,376 A \* 2/1997 Coleman ..... G06K 7/10594  
235/462.35

- D391,250 S \* 2/1998 Swift ..... D14/427
- D416,023 S \* 11/1999 Du ..... D14/242
- D462,688 S \* 9/2002 Schieffers ..... D14/420
- D515,546 S \* 2/2006 Mu ..... D14/203.3
- D554,641 S \* 11/2007 Miller ..... D14/427
- D572,250 S \* 7/2008 Yang ..... D14/435.1
- D585,066 S \* 1/2009 Morris ..... D14/427
- D587,209 S \* 2/2009 Tsai ..... D13/147
- D588,147 S \* 3/2009 Finlayson ..... D14/480.5
- D643,659 S \* 8/2011 Choi ..... D6/553
- D667,402 S \* 9/2012 Maus ..... D14/385

(Continued)

**FOREIGN PATENT DOCUMENTS**

- EM 003400324-0002 \* 10/2016
- WO D094333-001 \* 2/2017

**OTHER PUBLICATIONS**

Technology At Your Fingertips—Skoda Brings Smart Gloves to Its Factory, announced Aug. 25, 2016 [online], [site visited Jan. 10, 2018]. Available from Internet, URL: <<https://www.drivespark.com/off-beat/skoda-brings-pro-glove-to-factory-016564.html>>.\*

(Continued)

*Primary Examiner* — Barbara Fox  
*Assistant Examiner* — Dana K Weiland  
(74) *Attorney, Agent, or Firm* — Hayes Soloway P.C.

(57) **CLAIM**

The ornamental design for a barcode scanner, as shown and described.

**DESCRIPTION**

**1.1** is a top front perspective view of a barcode scanner showing the new design;  
**1.2** is a top view thereof;  
**1.3** is a rear view thereof;  
**1.4** is a top front view thereof; and  
**1.5** is a bottom view thereof.  
The broken lines in the drawings depict portions of the barcode scanner that form no part of the claimed design.

**1 Claim, 5 Drawing Sheets**

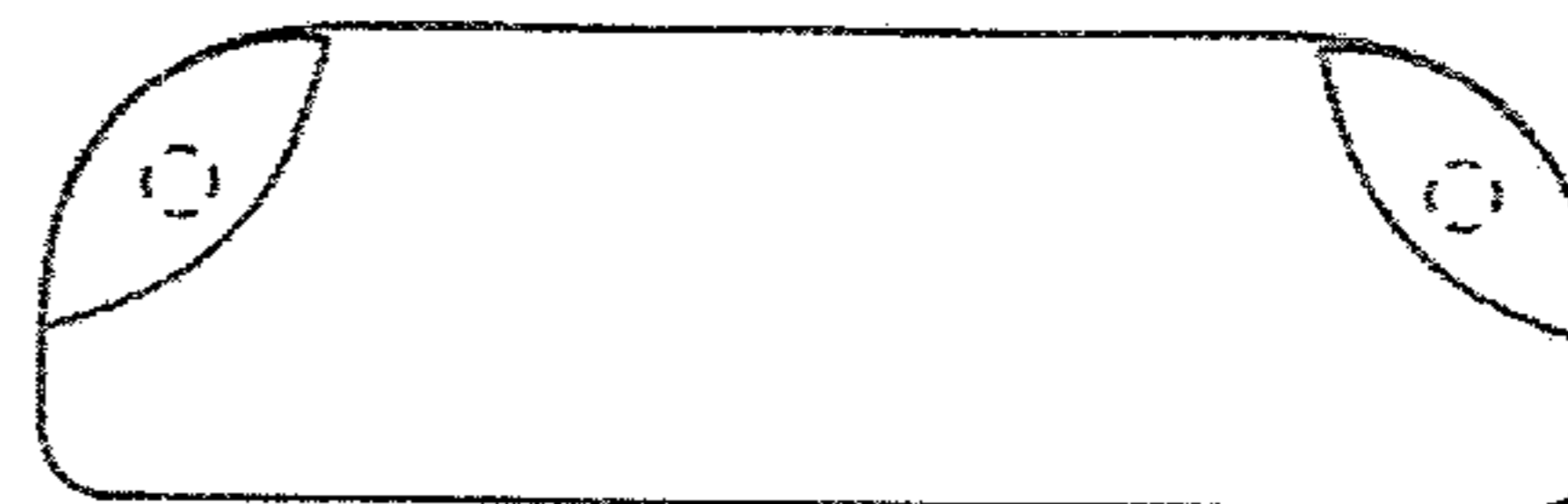
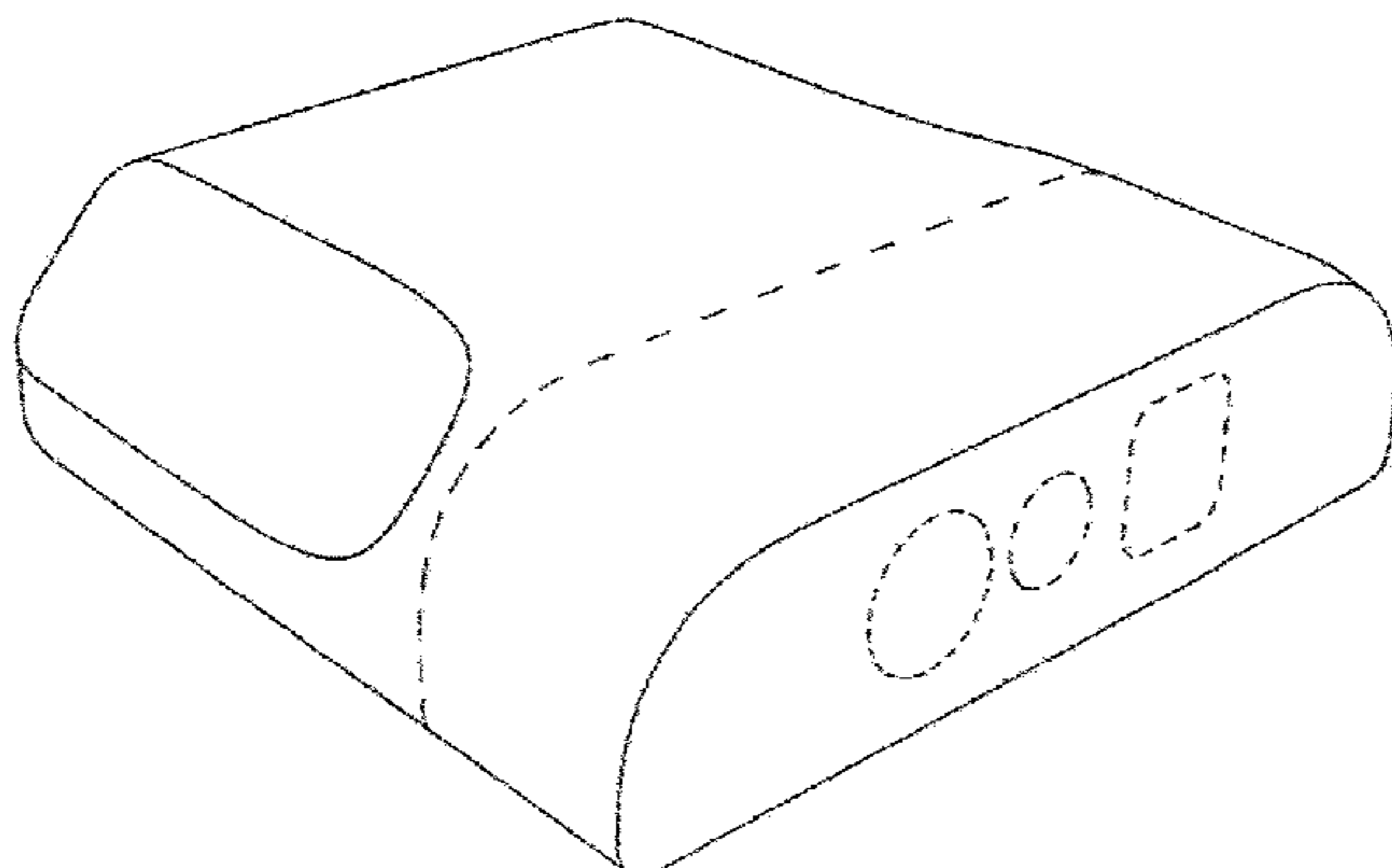

(56)

References Cited

U.S. PATENT DOCUMENTS

8,260,384 B2 \* 9/2012 Wulff ..... A45F 5/00  
 224/267  
 D673,564 S \* 1/2013 Milliff ..... D14/358  
 D688,198 S \* 8/2013 Takeshita ..... D13/103  
 D698,789 S \* 2/2014 Daniel ..... D14/385  
 D716,304 S \* 10/2014 Orthey ..... D14/385  
 D726,047 S \* 4/2015 Laurino ..... H04W 88/005  
 D10/78  
 D726,179 S \* 4/2015 Orthey ..... D14/358  
 D732,023 S \* 6/2015 Asao ..... D14/358  
 D740,827 S \* 10/2015 Sun ..... D14/427  
 D750,563 S \* 3/2016 Hedderich ..... D13/137.1  
 D750,986 S \* 3/2016 Laurino ..... H04W 88/005  
 D10/78  
 D782,972 S \* 4/2017 Laurino ..... D13/103  
 D784,308 S \* 4/2017 Buel ..... D14/242  
 D797,751 S \* 9/2017 Houston ..... D14/420  
 D818,856 S \* 5/2018 Laurino ..... D10/78  
 D818,947 S \* 5/2018 Laurino ..... D13/103  
 D819,025 S \* 5/2018 Shim ..... D14/365  
 D832,844 S \* 11/2018 Linn ..... D14/427  
 D833,437 S \* 11/2018 Campanini ..... D14/420  
 D833,438 S \* 11/2018 Lim ..... D14/427  
 D837,790 S \* 1/2019 Wu ..... D14/435  
 2005/0152537 A1 \* 7/2005 Goradesky ..... A45F 5/02  
 379/446  
 2007/0095871 A1 \* 5/2007 Chen ..... A45F 5/00  
 224/219

2008/0197195 A1 \* 8/2008 Miller ..... G06K 7/0004  
 235/440  
 2008/0237282 A1 \* 10/2008 Sin ..... A45F 5/02  
 224/197  
 2009/0032594 A1 \* 2/2009 Hazel ..... G06K 7/10881  
 235/454  
 2011/0059781 A1 \* 3/2011 Sin ..... A45C 11/00  
 455/575.6  
 2011/0319146 A1 \* 12/2011 Wilford ..... A45C 11/00  
 455/575.8  
 2012/0292096 A1 \* 11/2012 Wakileh ..... G02B 6/4448  
 174/480

OTHER PUBLICATIONS

Skoda introduces multi-function electronic gloves to production line, announced Aug. 22, 2016 [online], [site visited Jan. 10, 2018]. Available from Internet, URL: <<https://www.motor1.com/news/94609/skoda-introduces-multi-function-electronic-gloves-to-production-line/>>.\*  
 Electronics to wear, announced Oct. 28, 2016 [online], [site visited Jan. 10, 2018]. Available from Internet, URL: <<https://www.festo.com/group/en/cms/12276.htm>>.\*  
 ProGlove's Smart Glove Helps Manufacturing, . . . , announced Dec. 13, 2017 [online], [site visited Jan. 10, 2018]. Available from Internet, URL: <<http://www.nibletz.com/eureka-park/proglove-smartglove>>.\*

\* cited by examiner

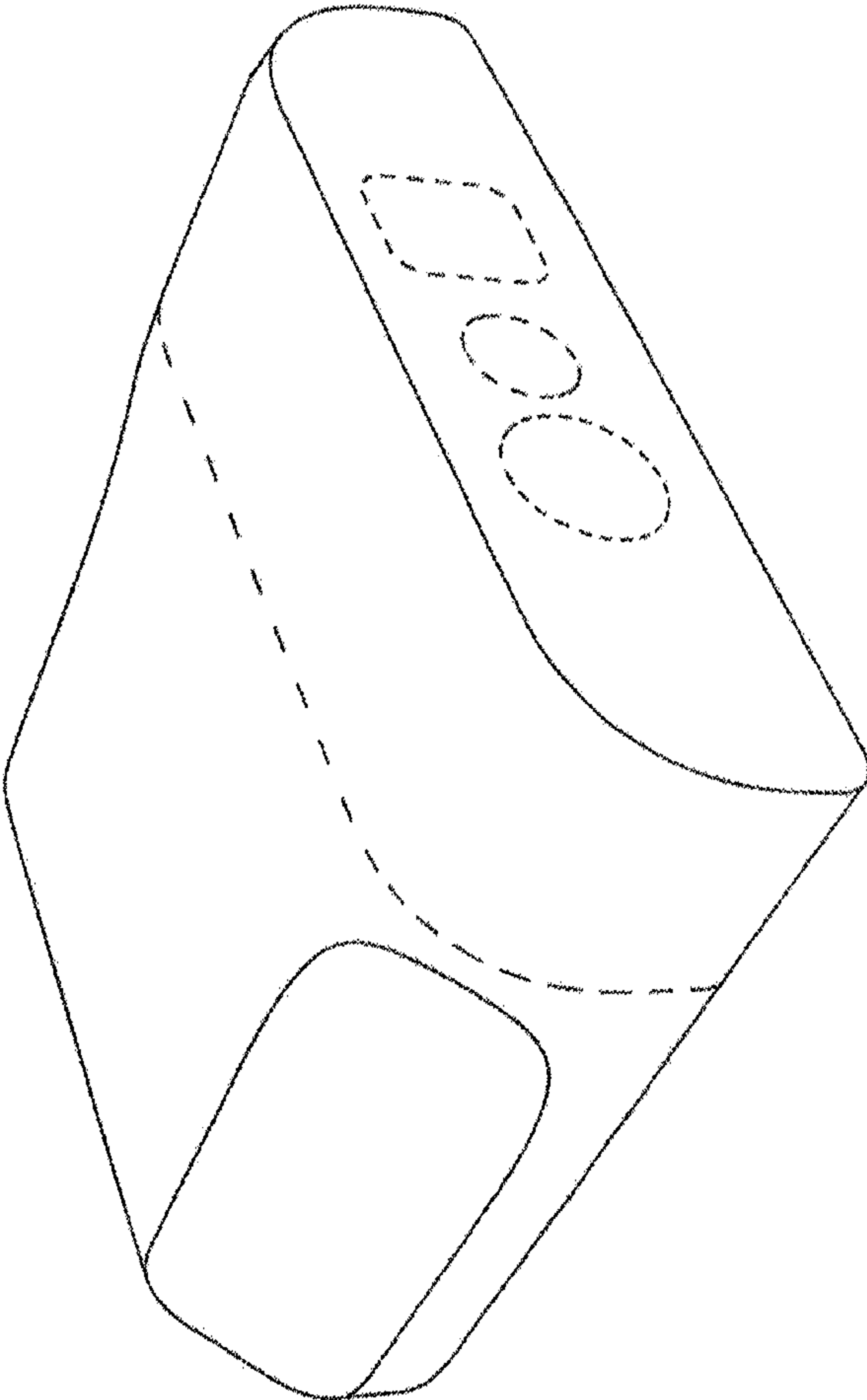

1.1

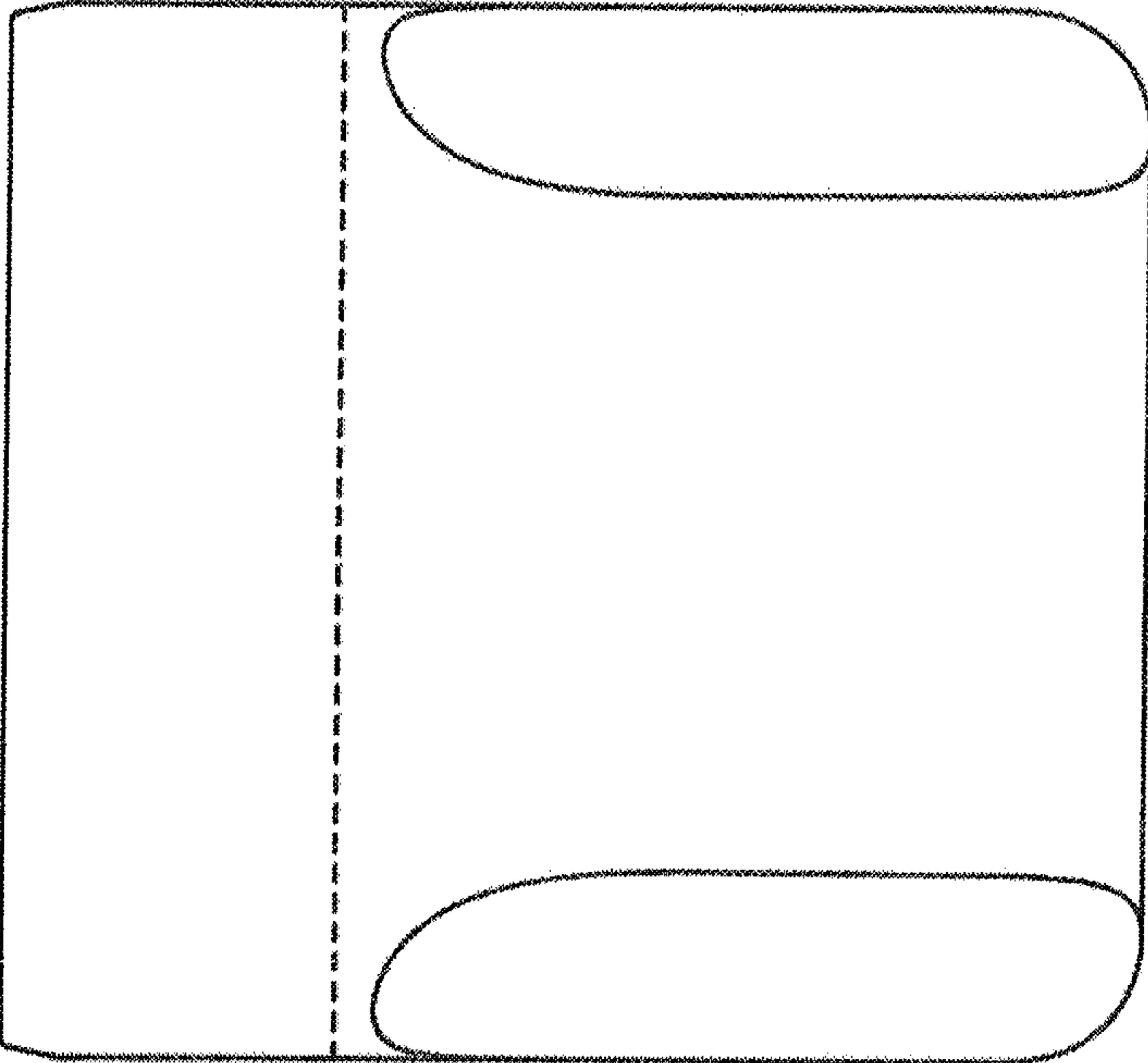

1.2

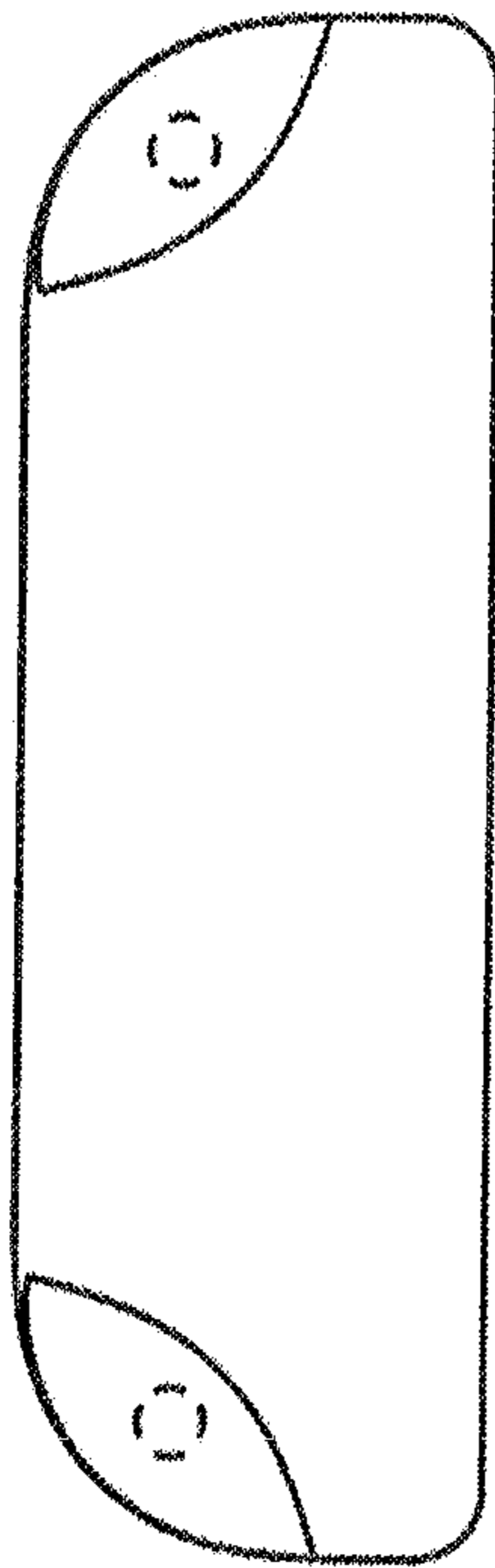

1.3

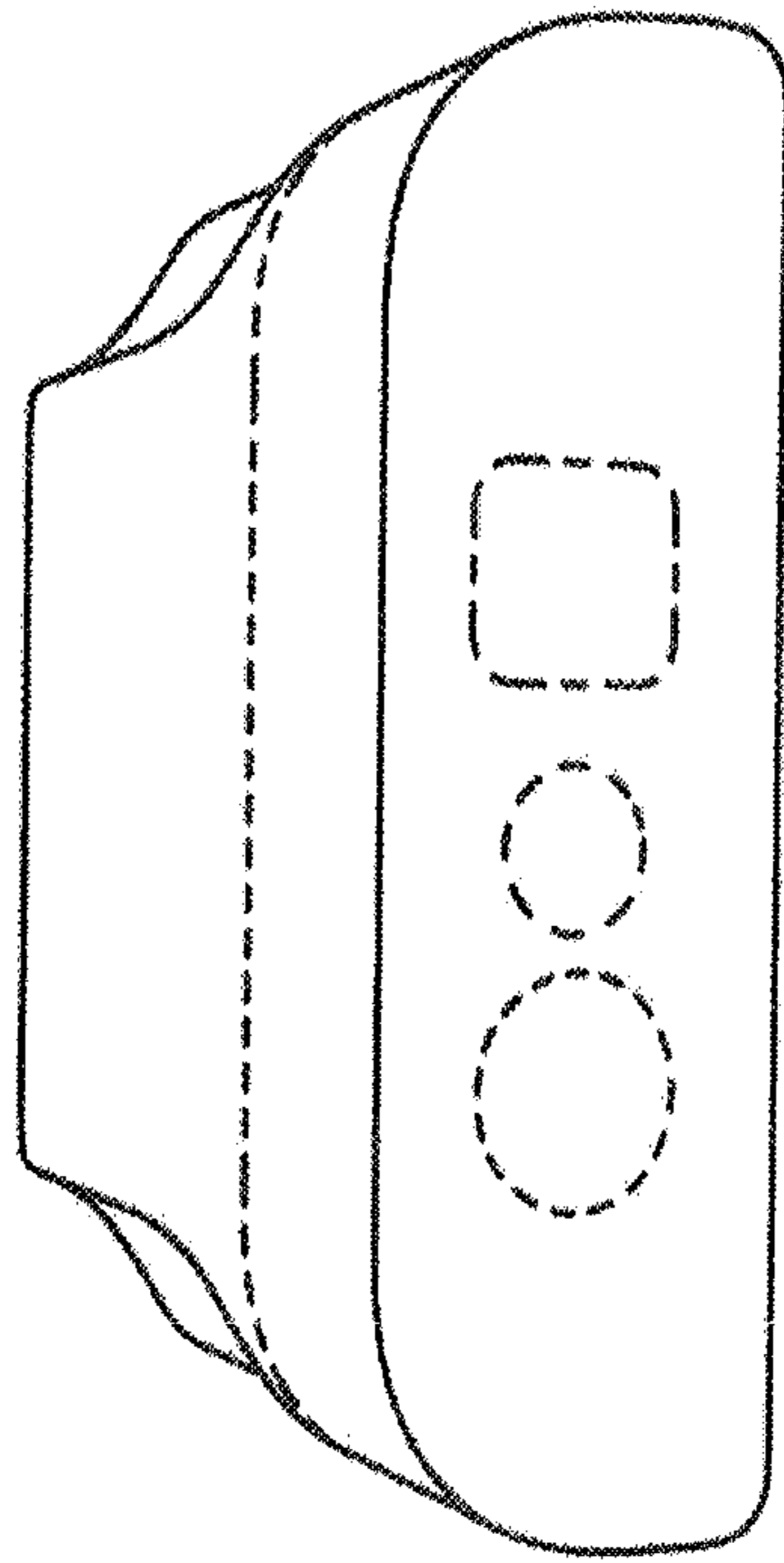

1.4

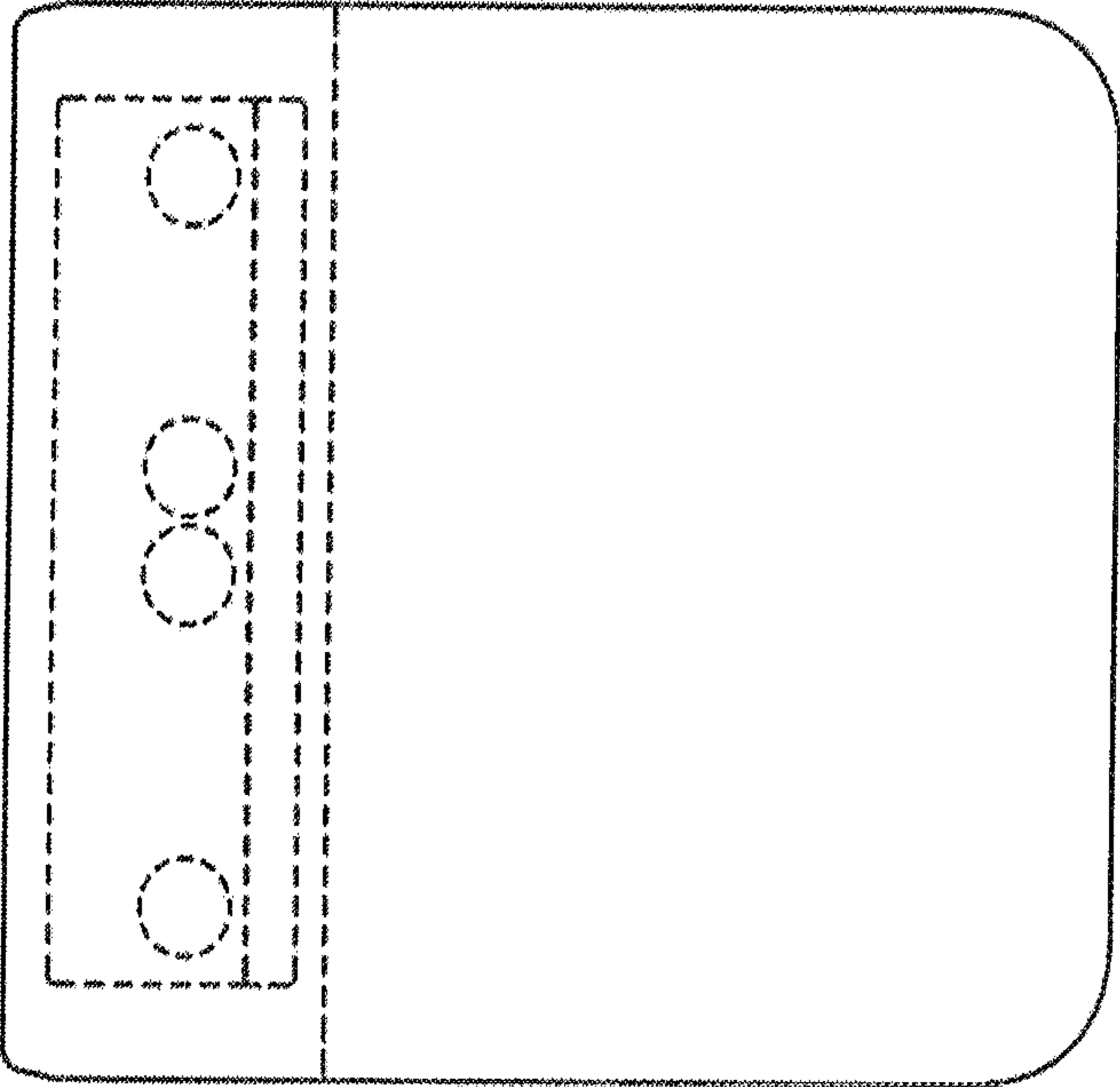

1.5