



US00D858386S

(12) **United States Design Patent** (10) **Patent No.:** **US D858,386 S**
Wymore et al. (45) **Date of Patent:** **** Sep. 3, 2019**

(54) **VEHICULAR FENDER**

DESCRIPTION

(71) Applicant: **Iddea California, LLC**, Brea, CA (US)

(72) Inventors: **Timothy J. Wymore**, Brea, CA (US);
Rodolfo A. Linares, Brea, CA (US)

(73) Assignee: **NAADE, Inc.**, Laredo, TX (US)

(**) Term: **15 Years**

(21) Appl. No.: **29/623,853**

(22) Filed: **Oct. 27, 2017**

(51) **LOC (12) Cl.** **12-16**

(52) **U.S. Cl.**
USPC **D12/184**

(58) **Field of Classification Search**
USPC D12/114, 181, 184, 196; D15/28
(Continued)

(56) **References Cited**

U.S. PATENT DOCUMENTS

6,155,624 A 12/2000 Bienenstein, Jr.
8,146,987 B2 4/2012 Uchino
(Continued)

OTHER PUBLICATIONS

Google Search, jeep replacement fenders, web page <https://www.google.com/search?q=jeep+replacement+fenders&source=lnms&tbm=shop&sa=X&ved=0ahUKEwiPIYfcjtHYAhVRHGmKHXUSA6kQ_AUICigB&biw=1329&bih=737>, Jan. 5, 2018, 4 pages.
(Continued)

Primary Examiner — Susan Bennett Hattan
Assistant Examiner — Suzanne E Tisdell
(74) *Attorney, Agent, or Firm* — Stetina Brunda Garred and Brucker

(57) **CLAIM**

The ornamental design for a vehicular fender, as shown and described.

FIG. 1 is a front perspective view of the vehicular fender of the present invention showing our new design;
FIG. 2 is a top plan view thereof;
FIG. 3 is a front elevational view thereof;
FIG. 4 is a right side elevational view thereof;
FIG. 5 is a rear elevational view thereof;
FIG. 6 is a left side elevational view thereof; and
FIG. 7 is a bottom plan view thereof.
FIG. 8 is a front perspective view of a second embodiment of the vehicular fender of the present invention showing our new design;
FIG. 9 is a top plan view thereof;
FIG. 10 is a front elevational view thereof;
FIG. 11 is a right side elevational view thereof;
FIG. 12 is a rear elevational view thereof;
FIG. 13 is a left side elevational view thereof; and
FIG. 14 is a bottom plan view thereof.
FIG. 15 is a front perspective view of a third embodiment of the vehicular fender of the present invention showing our new design;
FIG. 16 is a top plan view thereof;
FIG. 17 is a front elevational view thereof;
FIG. 18 is a right side elevational view thereof;
FIG. 19 is a rear elevational view thereof;
FIG. 20 is a left side elevational view thereof; and
FIG. 21 is a bottom plan view thereof.
FIG. 22 is a front perspective view of a fourth embodiment of the vehicular fender of the present invention showing our new design;
FIG. 23 is a top plan view thereof;
FIG. 24 is a front elevational view thereof;
FIG. 25 is a right side elevational view thereof;
FIG. 26 is a rear elevational view thereof;
FIG. 27 is a left side elevational view thereof; and,
FIG. 28 is a bottom plan view thereof.
The dotted lines in the figures depict environmental structure and form no part of the claimed design.

1 Claim, 12 Drawing Sheets

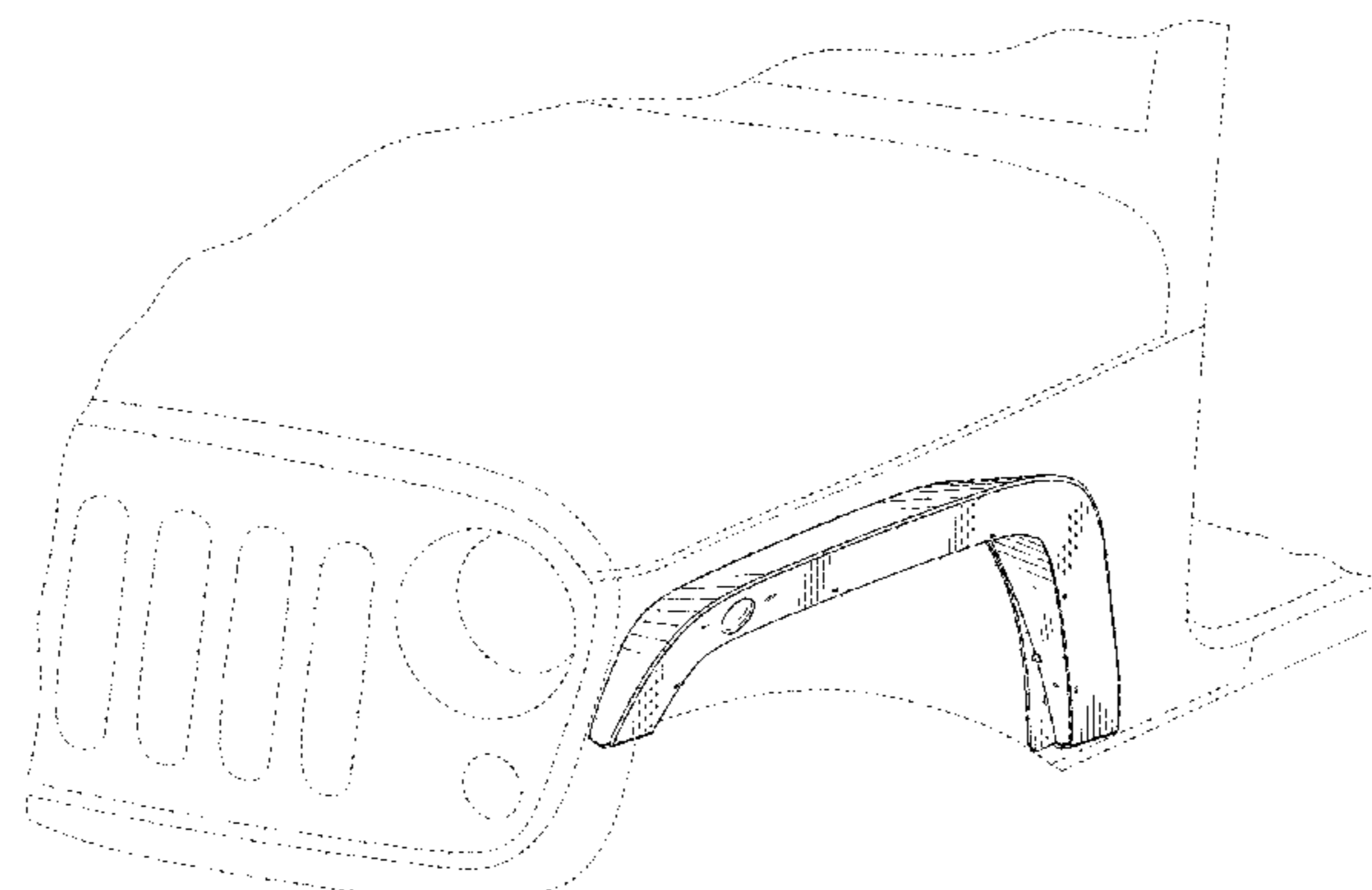

(58) **Field of Classification Search**
 CPC B62D 25/16; B62D 25/18
 See application file for complete search history.

(56) **References Cited**

U.S. PATENT DOCUMENTS

9,278,716 B1 * 3/2016 Joseph B62D 25/18
 D756,870 S * 5/2016 Tsutamori D12/184
 D758,935 S * 6/2016 Platto D12/184
 9,403,557 B1 * 8/2016 Sharma C21D 1/06
 9,487,238 B2 * 11/2016 Iwano B62D 25/025
 D775,031 S * 12/2016 Frascella D12/184
 D787,395 S * 5/2017 Curic D12/181
 9,669,876 B2 * 6/2017 Iwano B62D 25/04
 9,738,322 B2 * 8/2017 Matthiessen B62D 25/02
 D803,119 S * 11/2017 Beermann D12/184
 D803,741 S * 11/2017 Tsubaki D12/184
 D805,013 S * 12/2017 Whitla D12/181
 D806,622 S * 1/2018 Granlund D12/184
 D807,261 S * 1/2018 Zavatski D12/184

9,890,966 B2 * 2/2018 Mueller B62D 25/16
 D817,829 S * 5/2018 Behmer D12/184
 D820,751 S * 6/2018 Luk D12/184
 D823,741 S * 7/2018 Kim D12/169
 10,023,241 B2 * 7/2018 Umemoto B62D 25/161
 10,035,543 B2 * 7/2018 Sato B60J 5/0444
 D826,811 S * 8/2018 Lim D12/184
 D827,527 S * 9/2018 Loeb D12/184
 D827,528 S * 9/2018 Gueler D12/184
 D827,529 S * 9/2018 Al Attar D12/184
 D828,254 S * 9/2018 Simm D12/184
 10,077,085 B2 * 9/2018 Pfaffelhuber B62D 27/02
 2008/0231082 A1 9/2008 Mathew

OTHER PUBLICATIONS

amazon.com, fenders jeep wrangler, web page <https://www.amazon.com/s/ref=nb_sb_noss_2?url=search-alias%3Daps&field-keywords=fenders+jeep+wrangler>, Jan. 11, 2018, 14 pages.

* cited by examiner

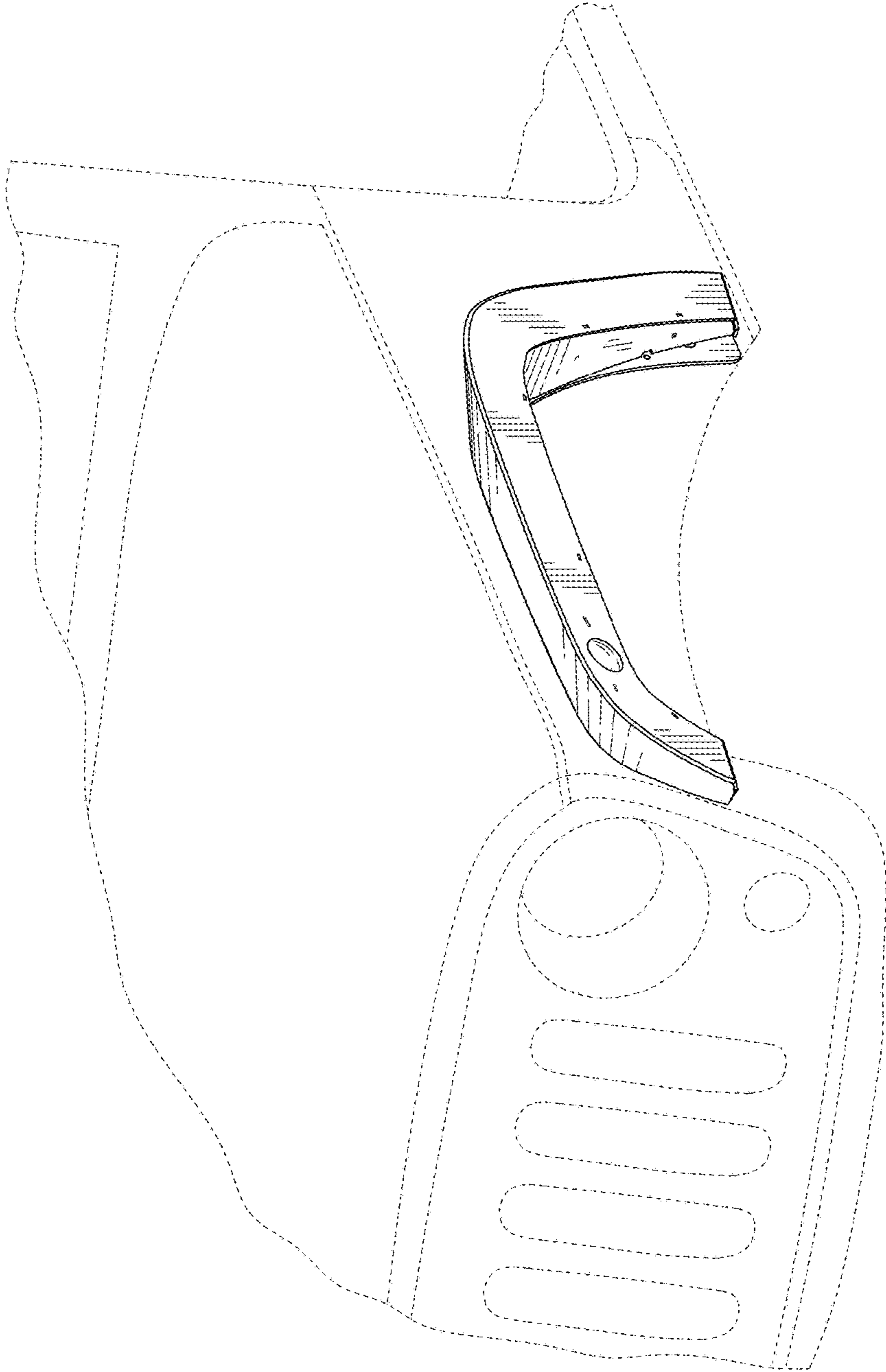

FIG. 1

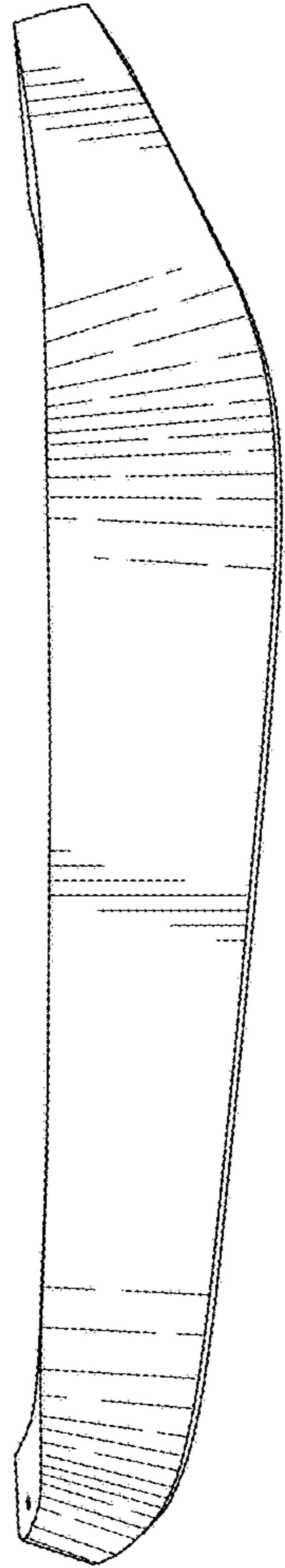

FIG. 2

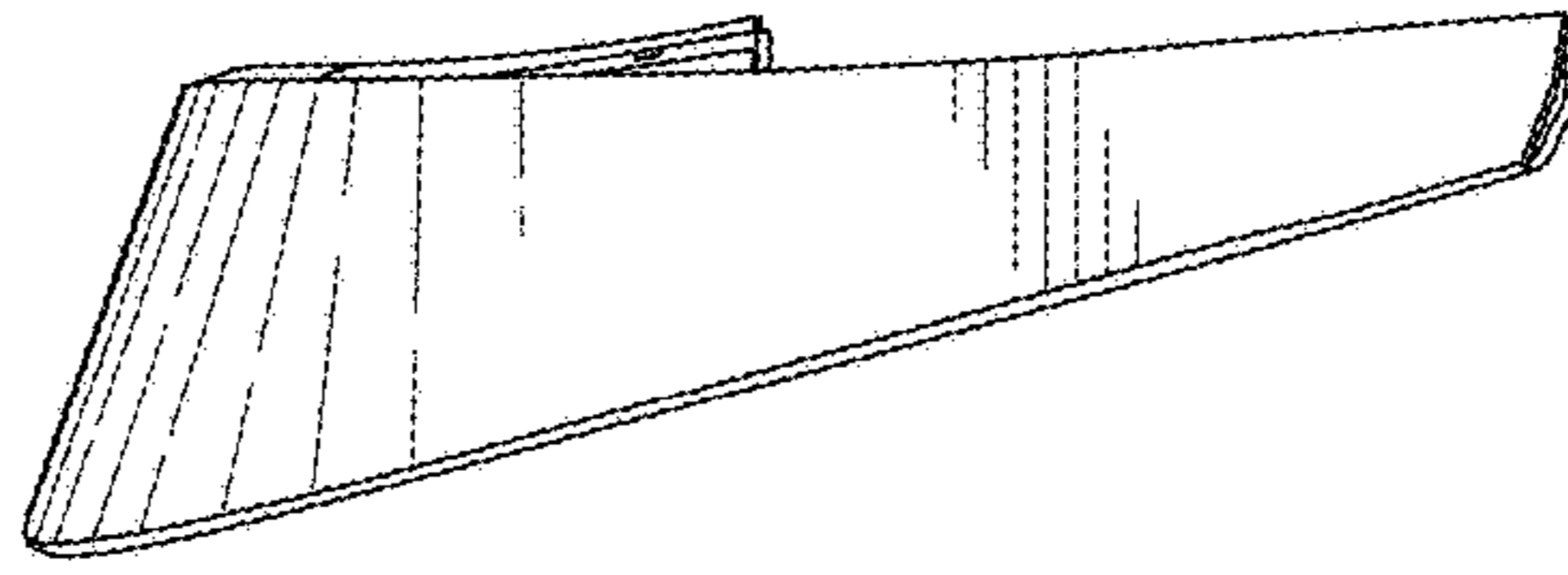

FIG. 4

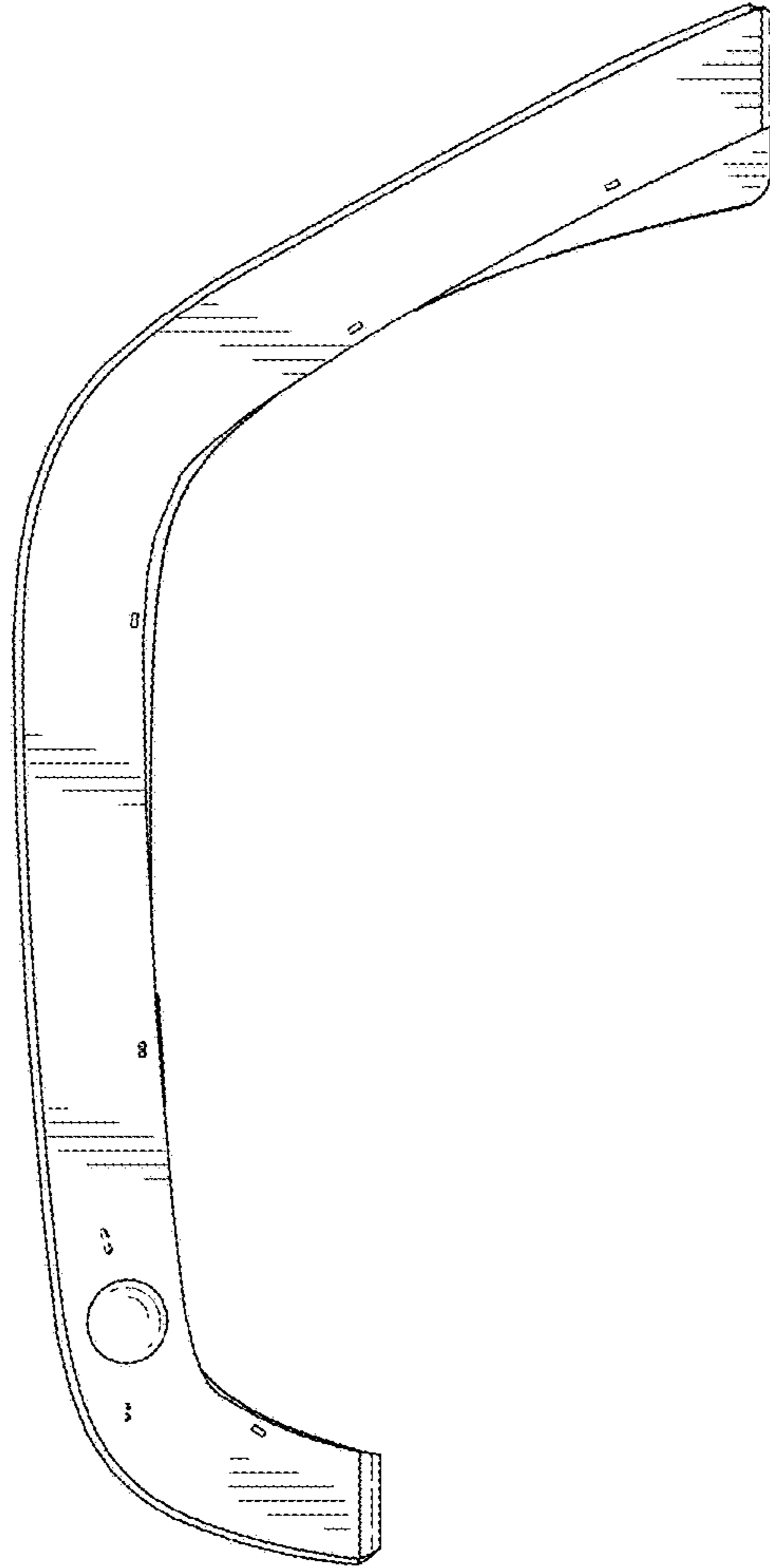

FIG. 3

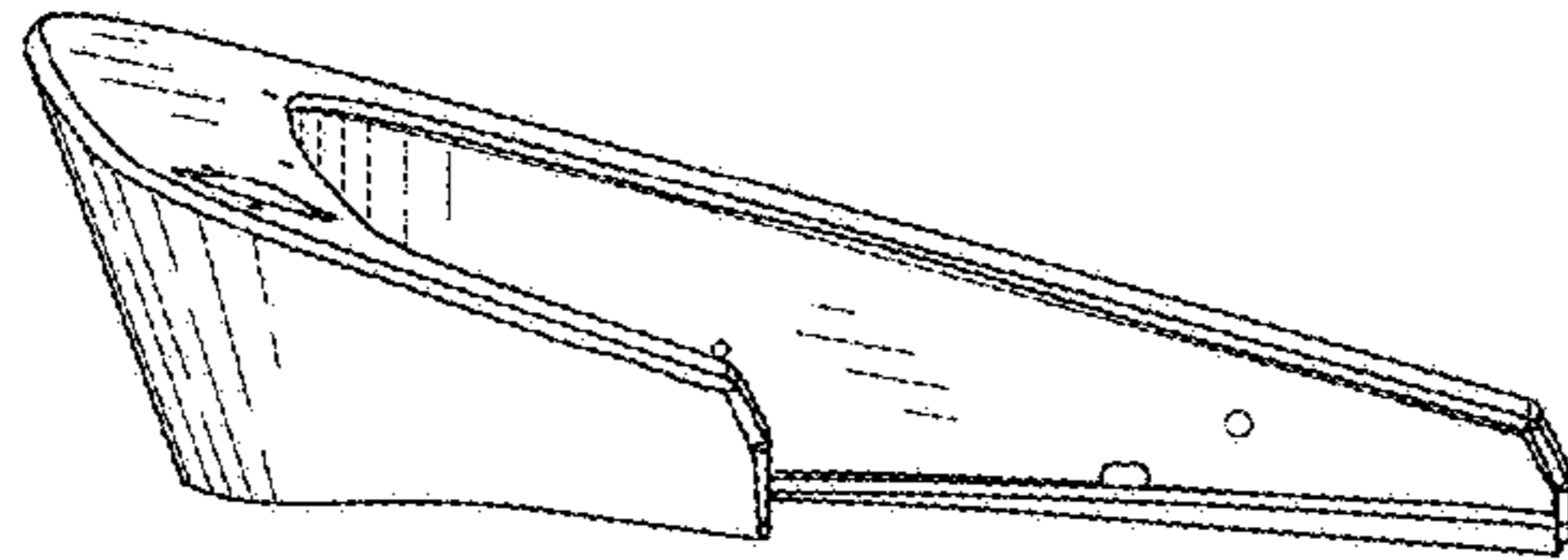

FIG. 6

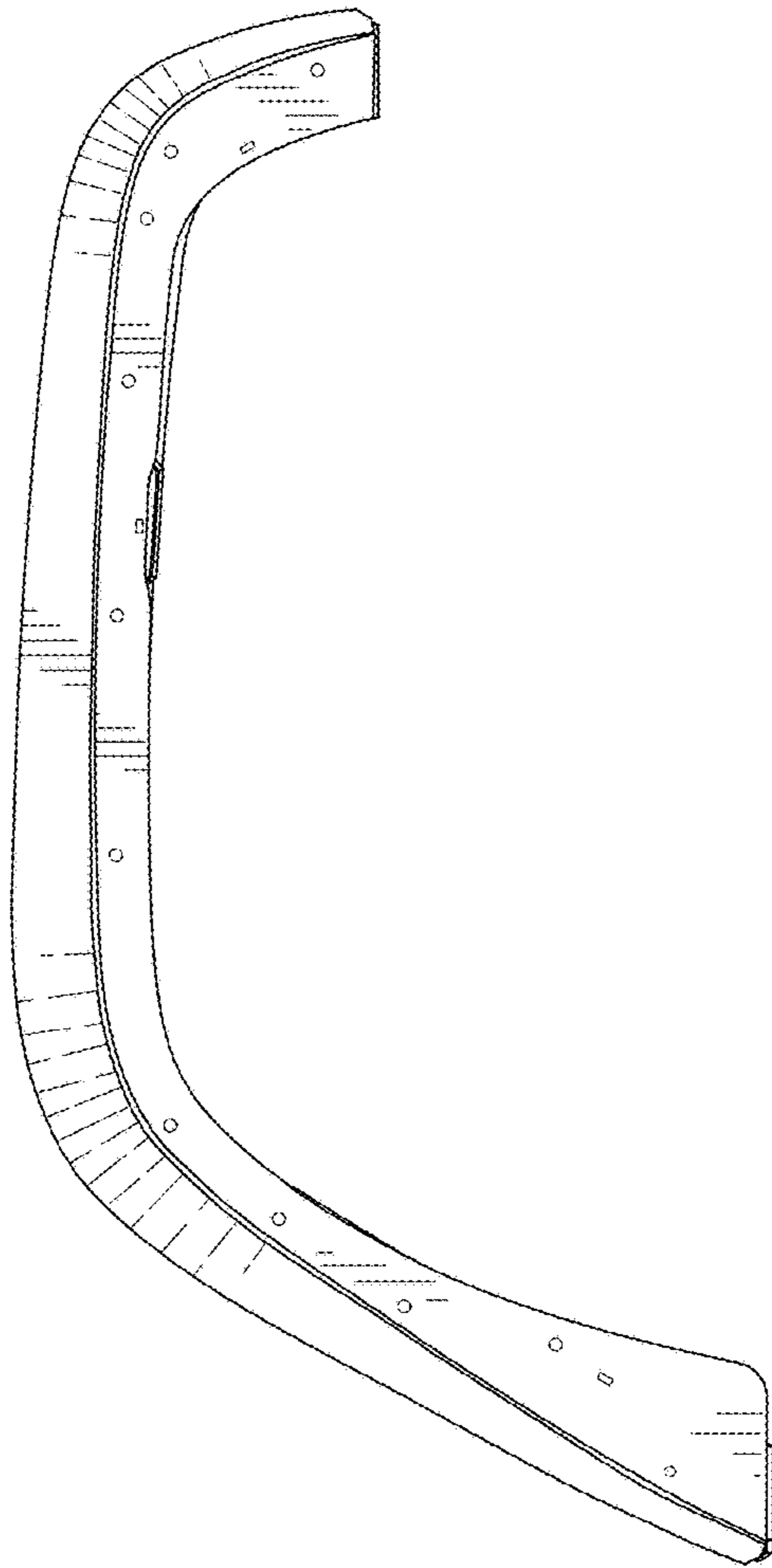

FIG. 5

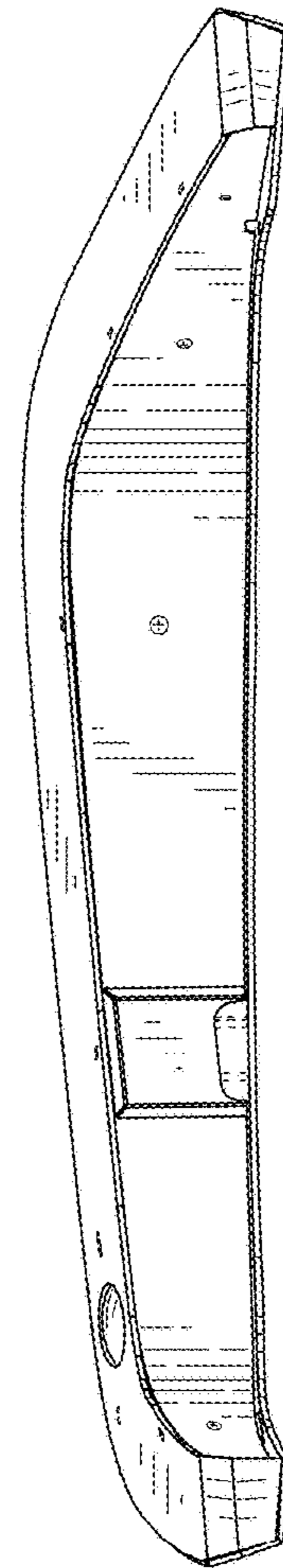

FIG. 7

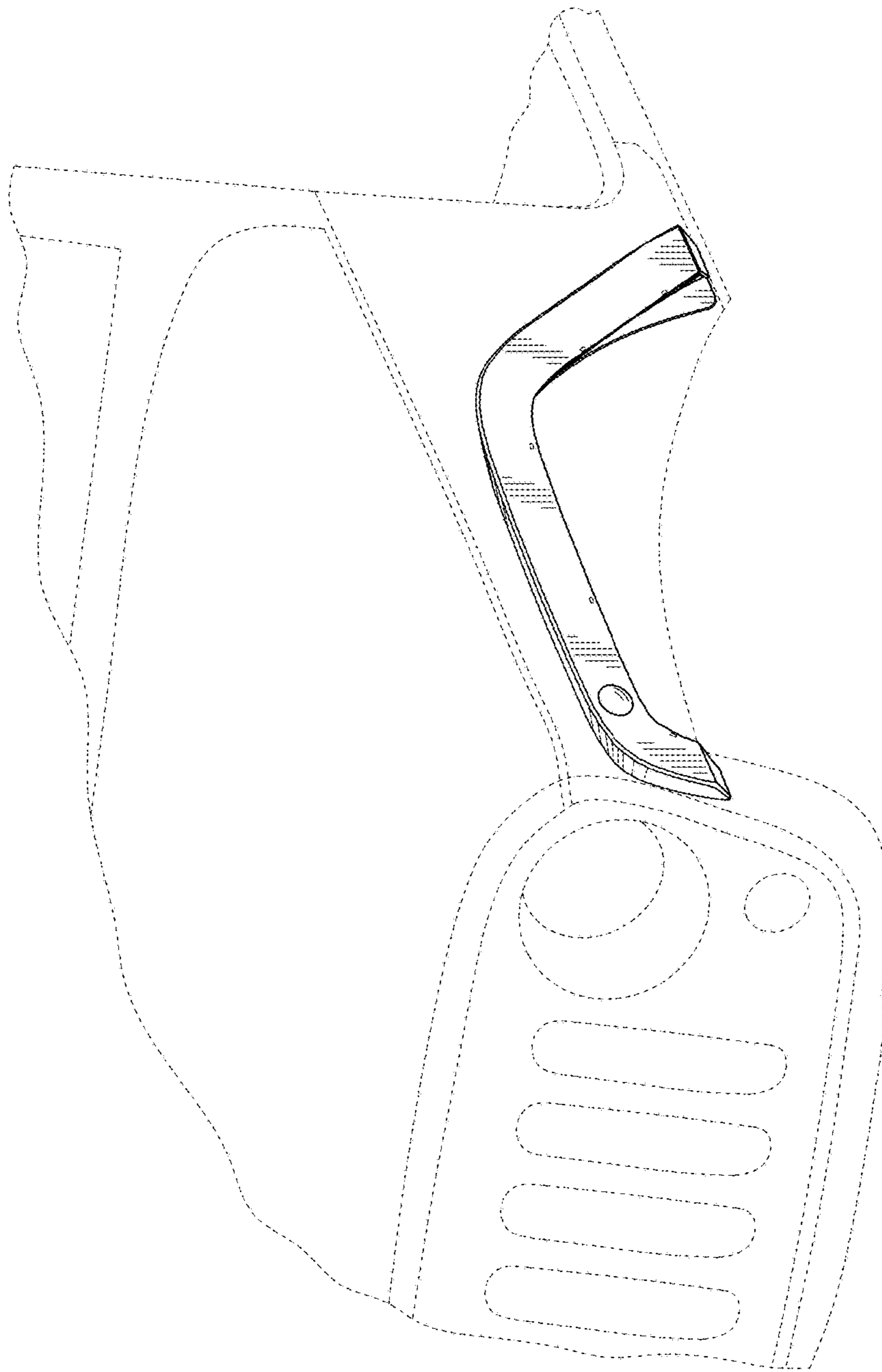

FIG. 8

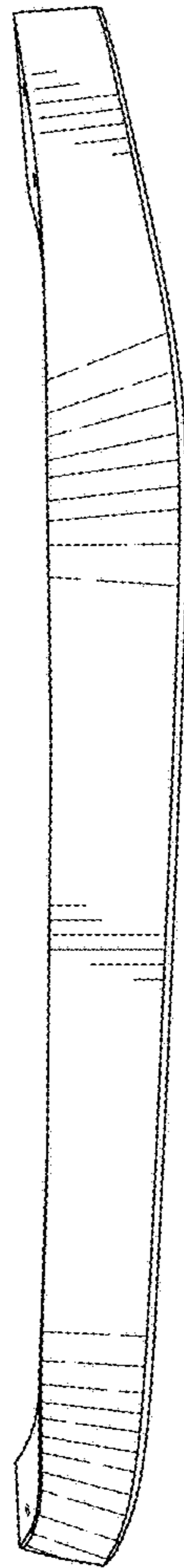

FIG. 9

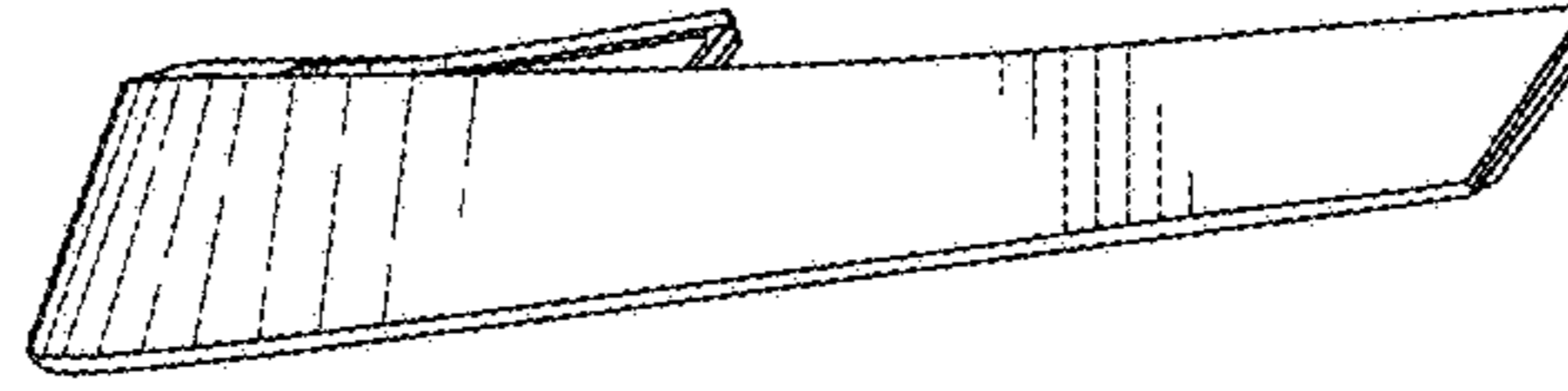

FIG. 11

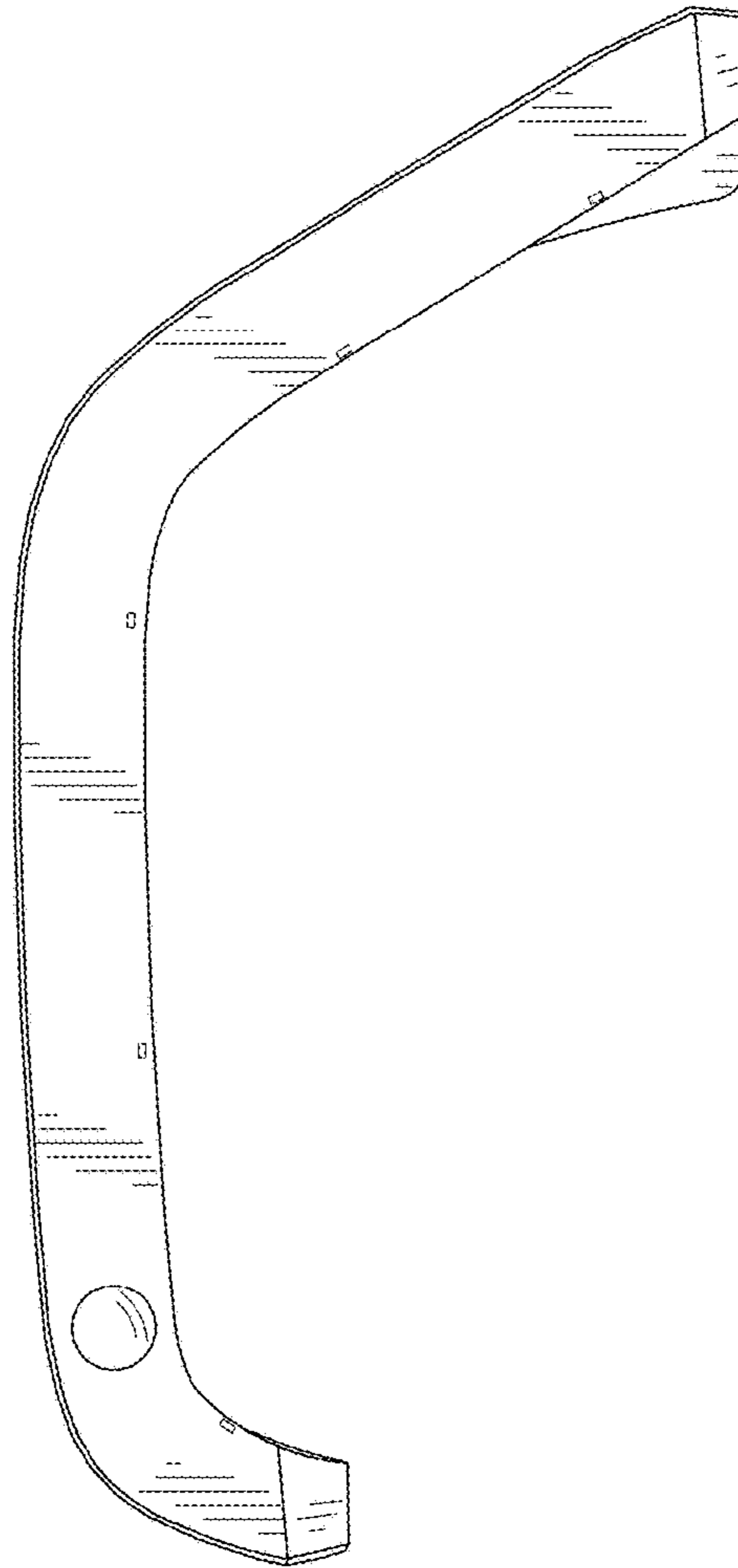

FIG. 10

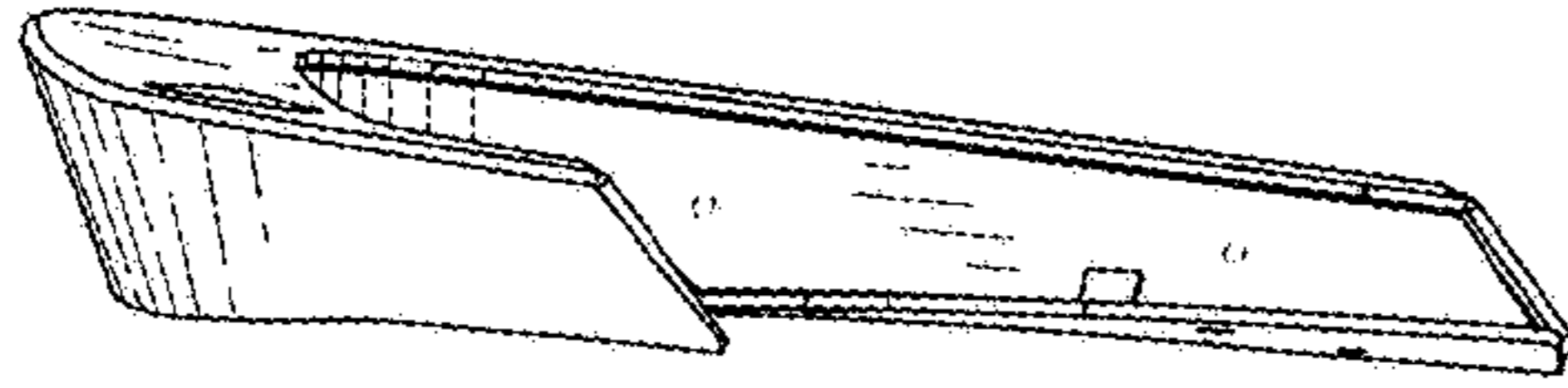

FIG. 13

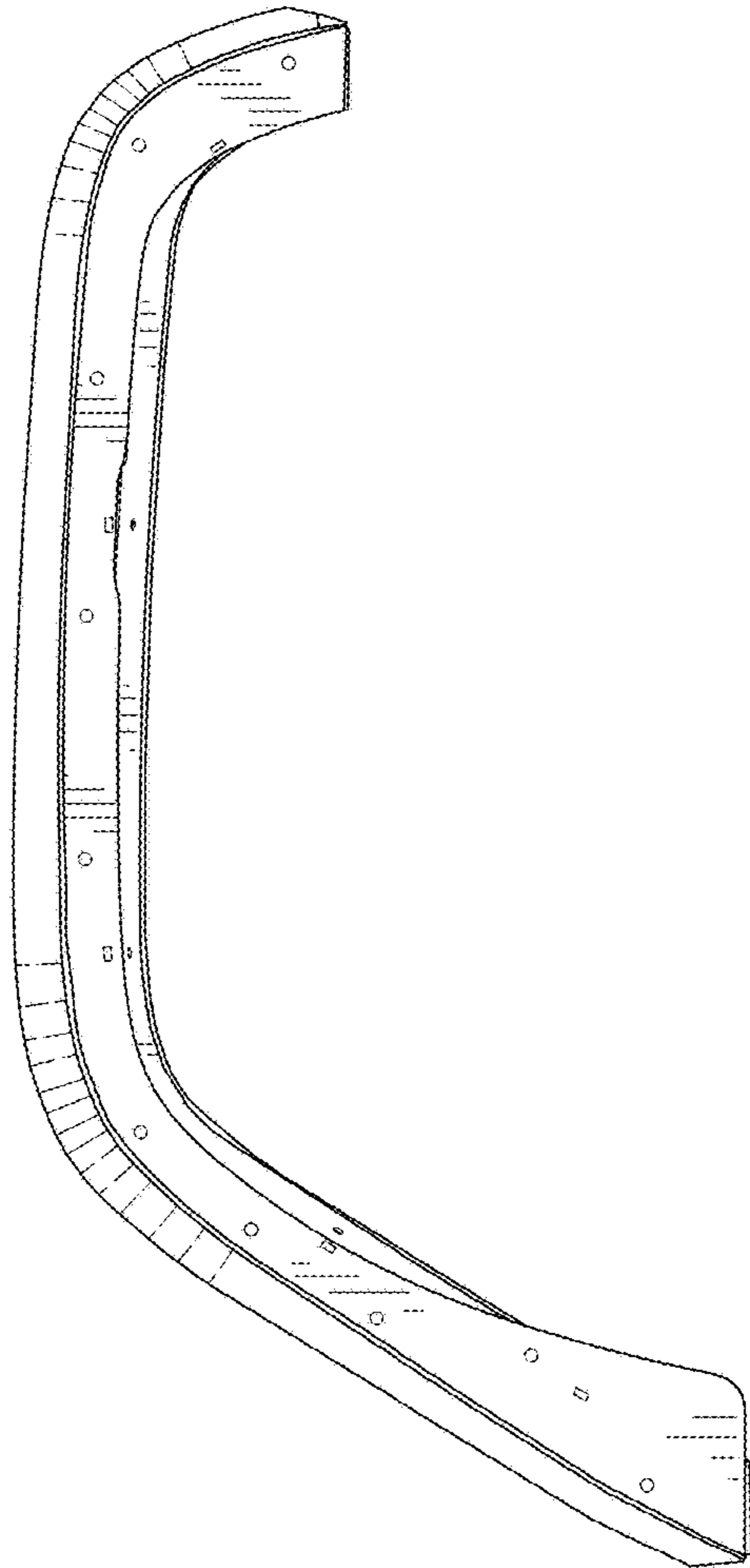

FIG. 12

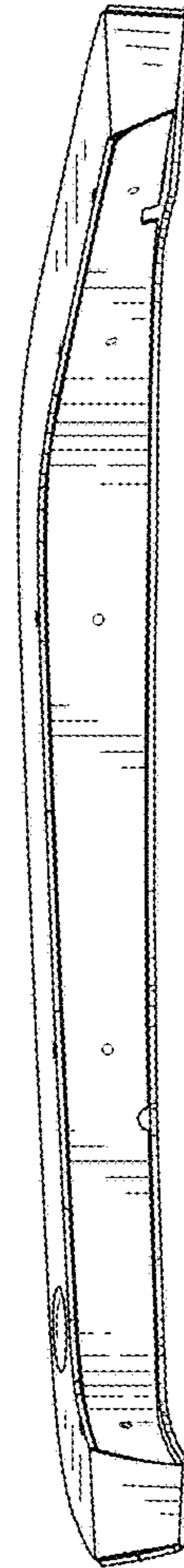

FIG. 14

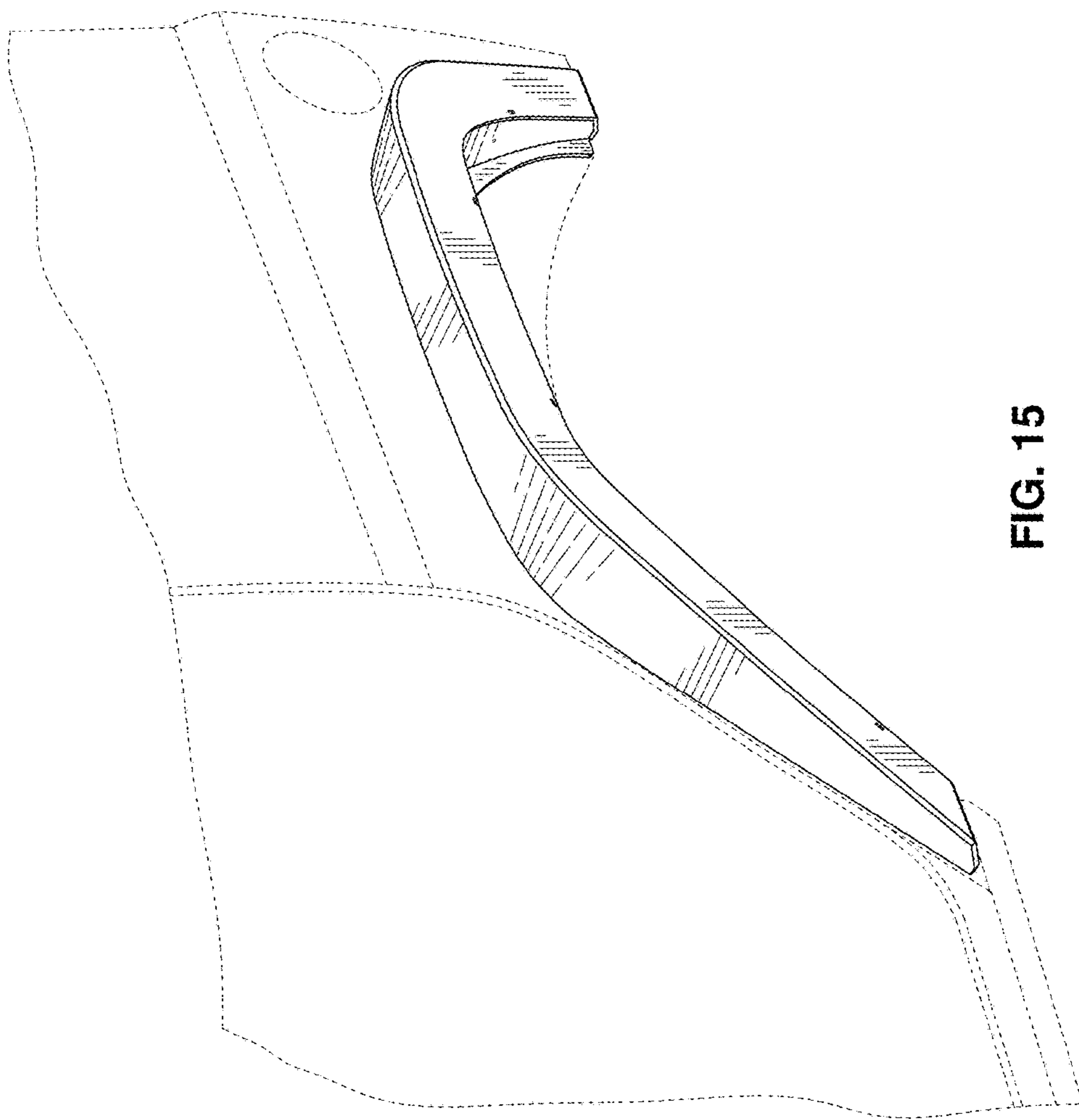

FIG. 15

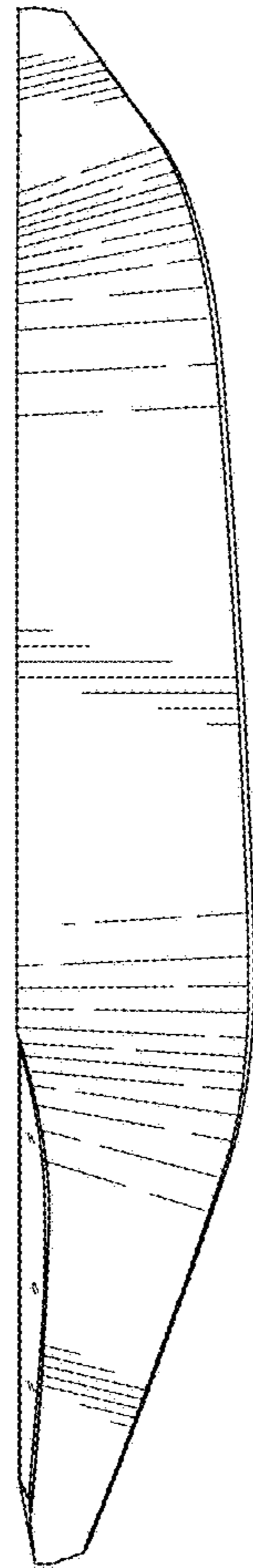

FIG. 16

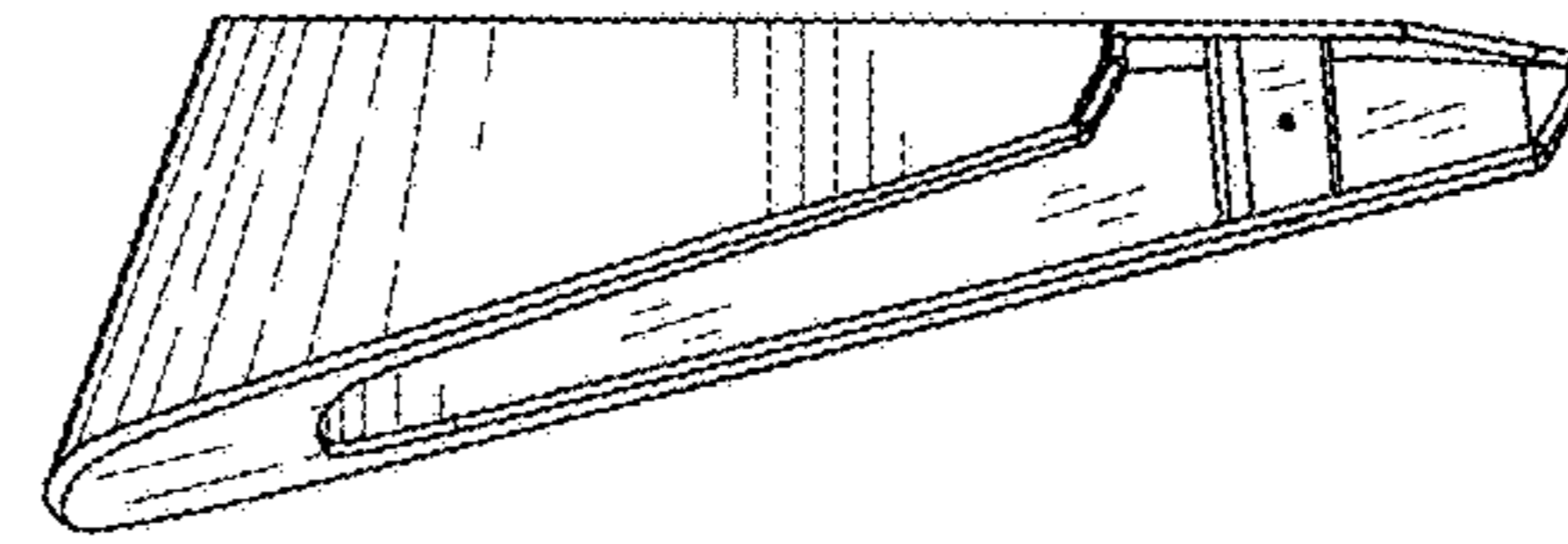

FIG. 18

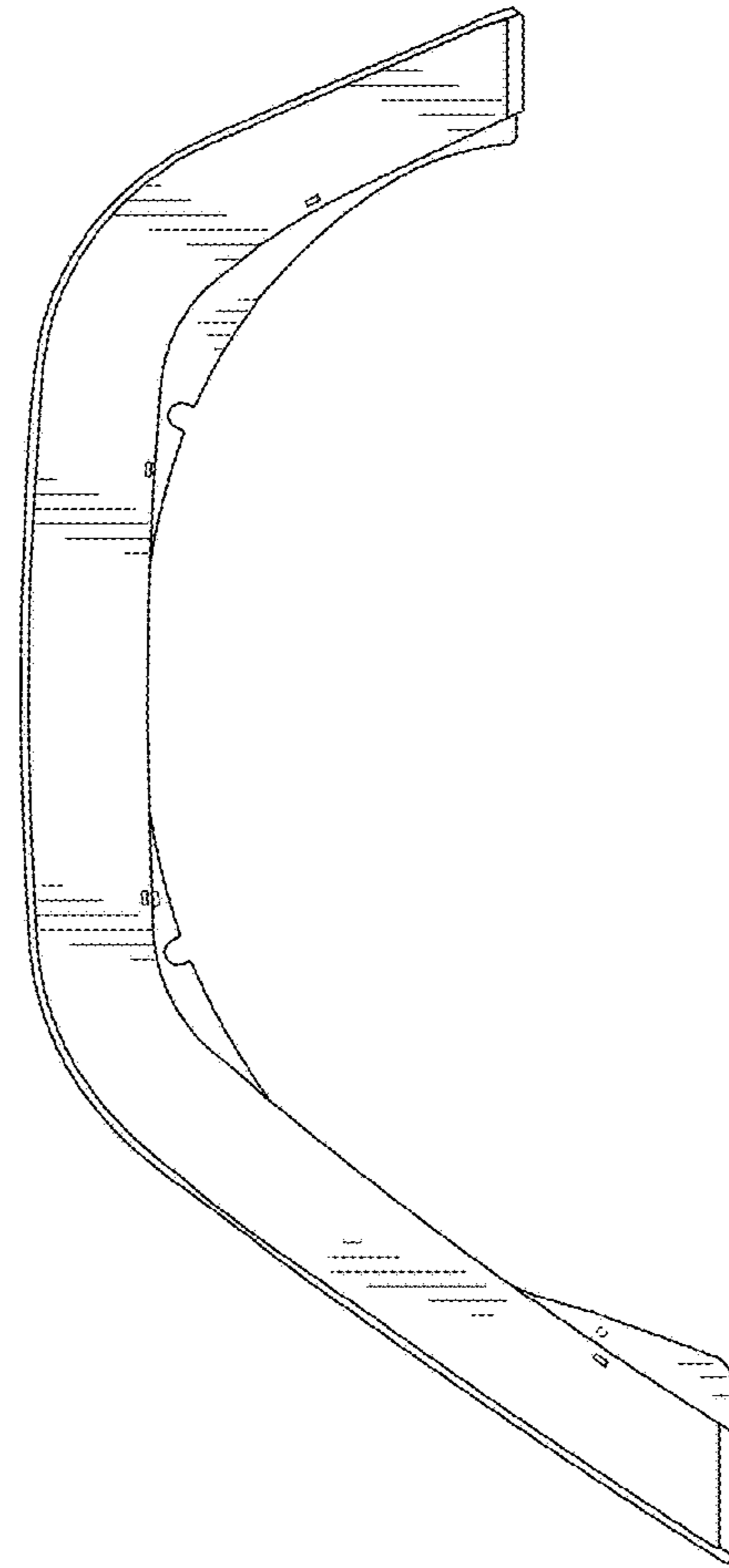

FIG. 17

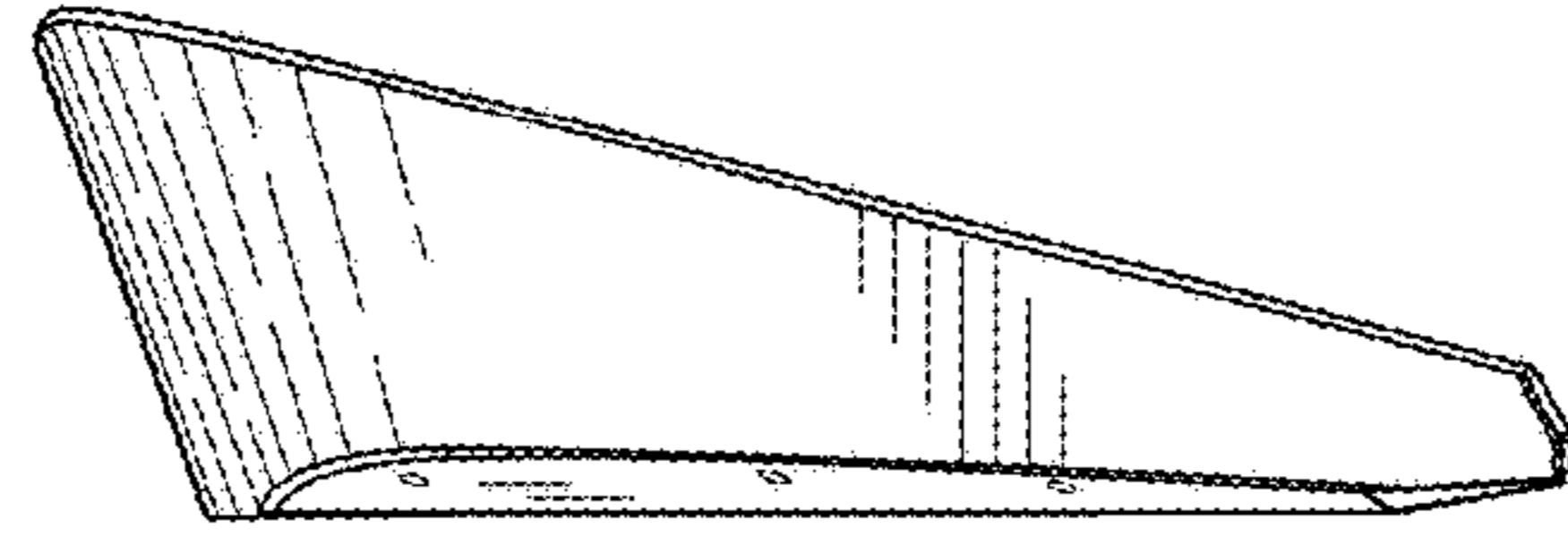

FIG. 20

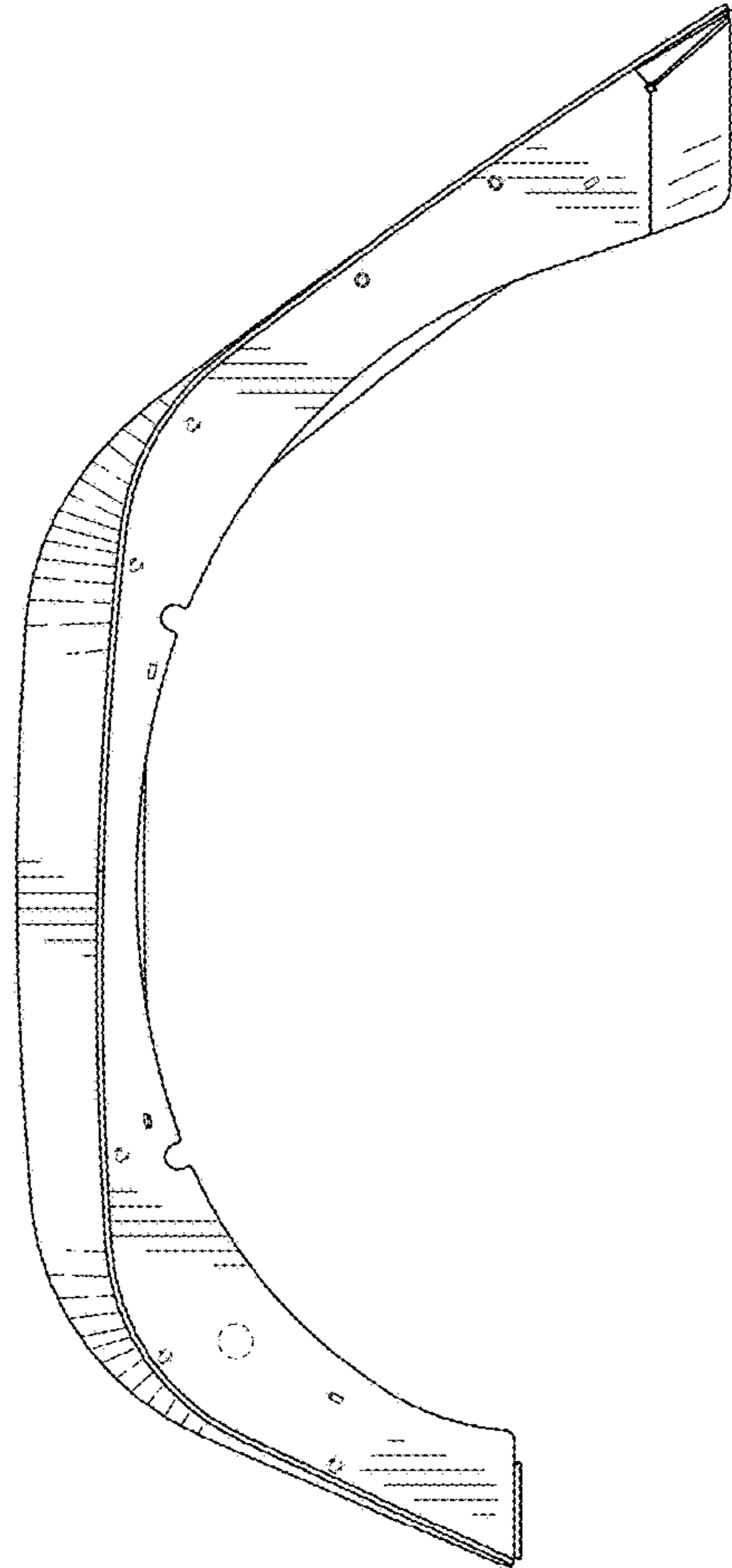

FIG. 19

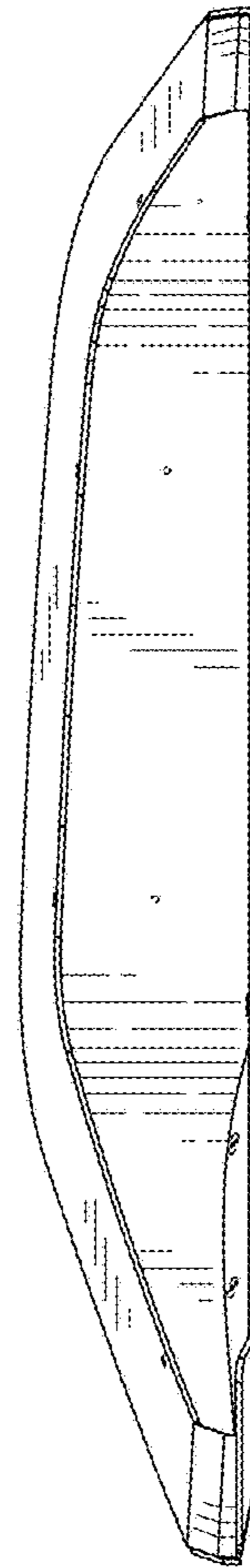

FIG. 21

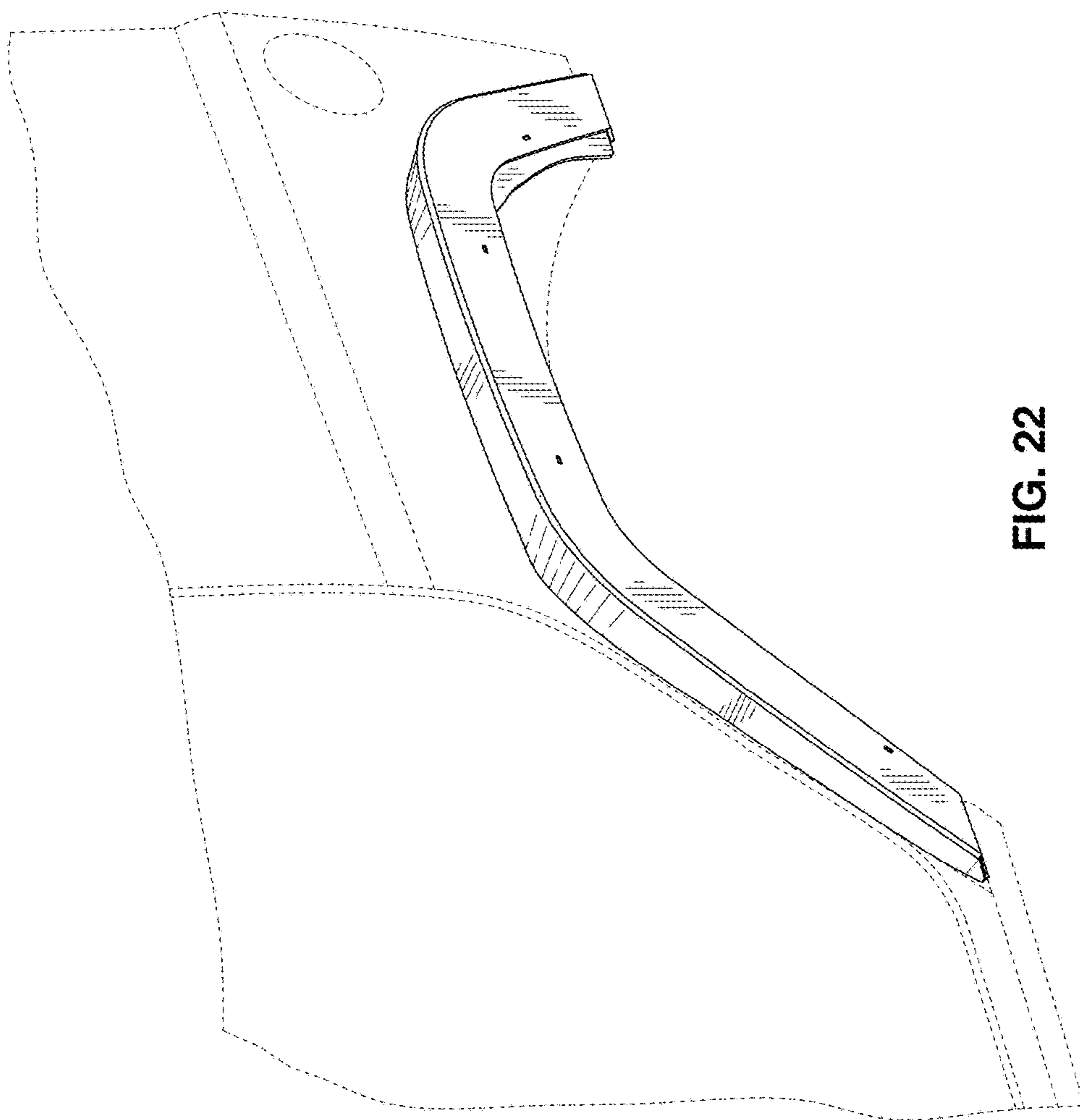

FIG. 22



FIG. 23

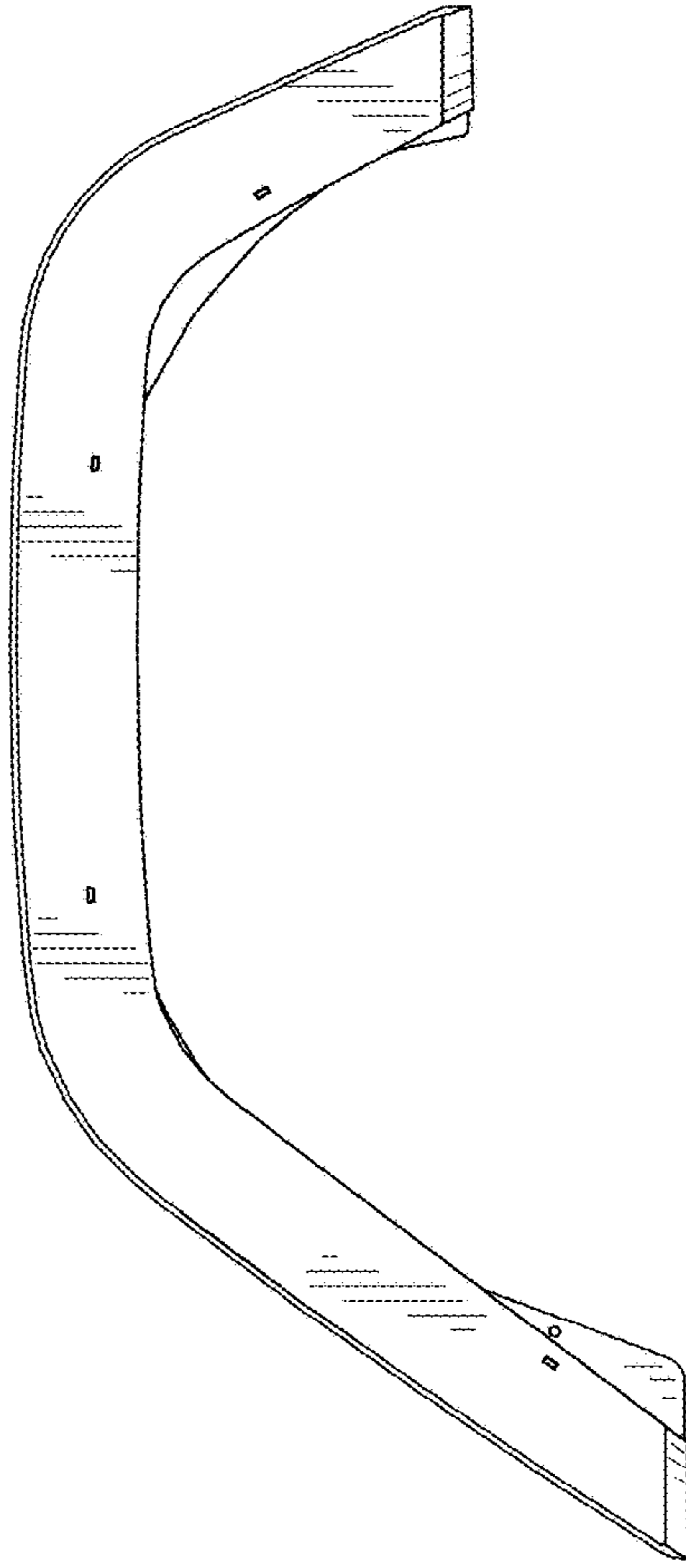

FIG. 24

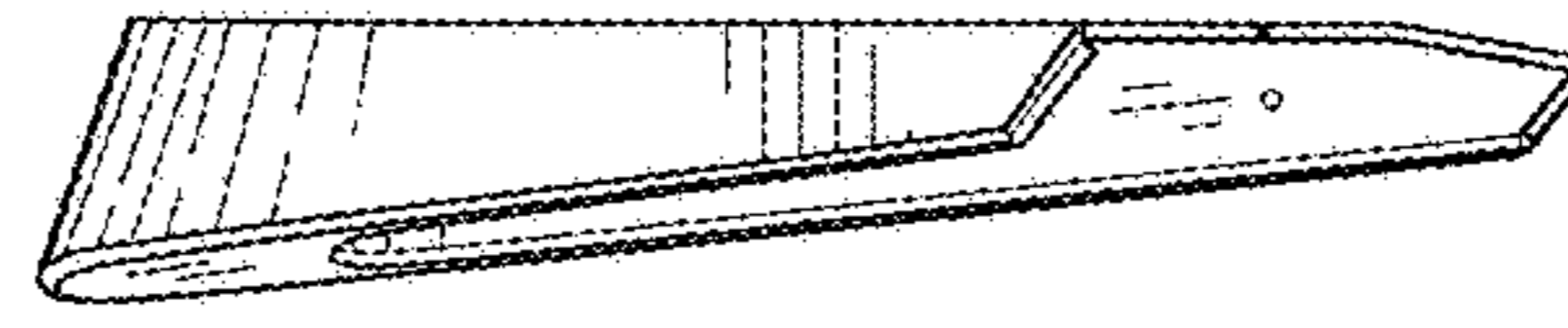

FIG. 25

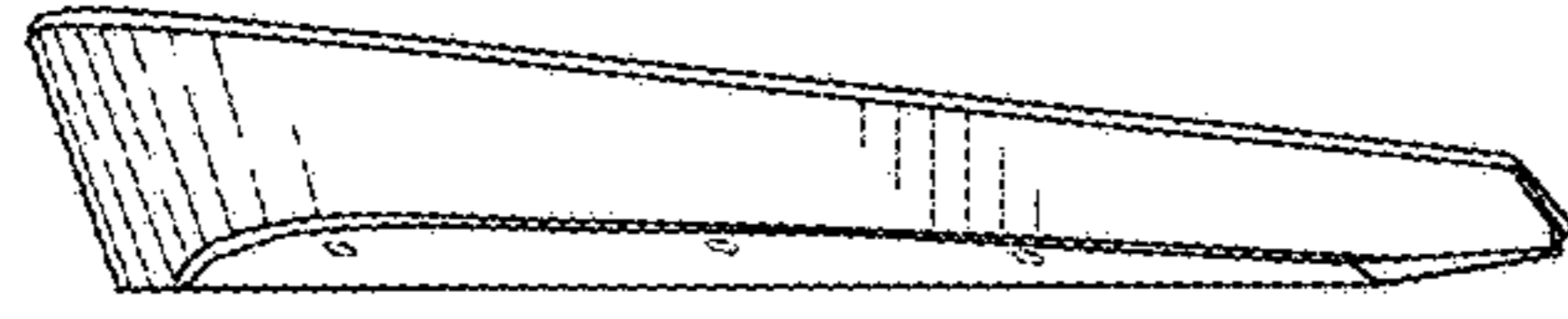

FIG. 27

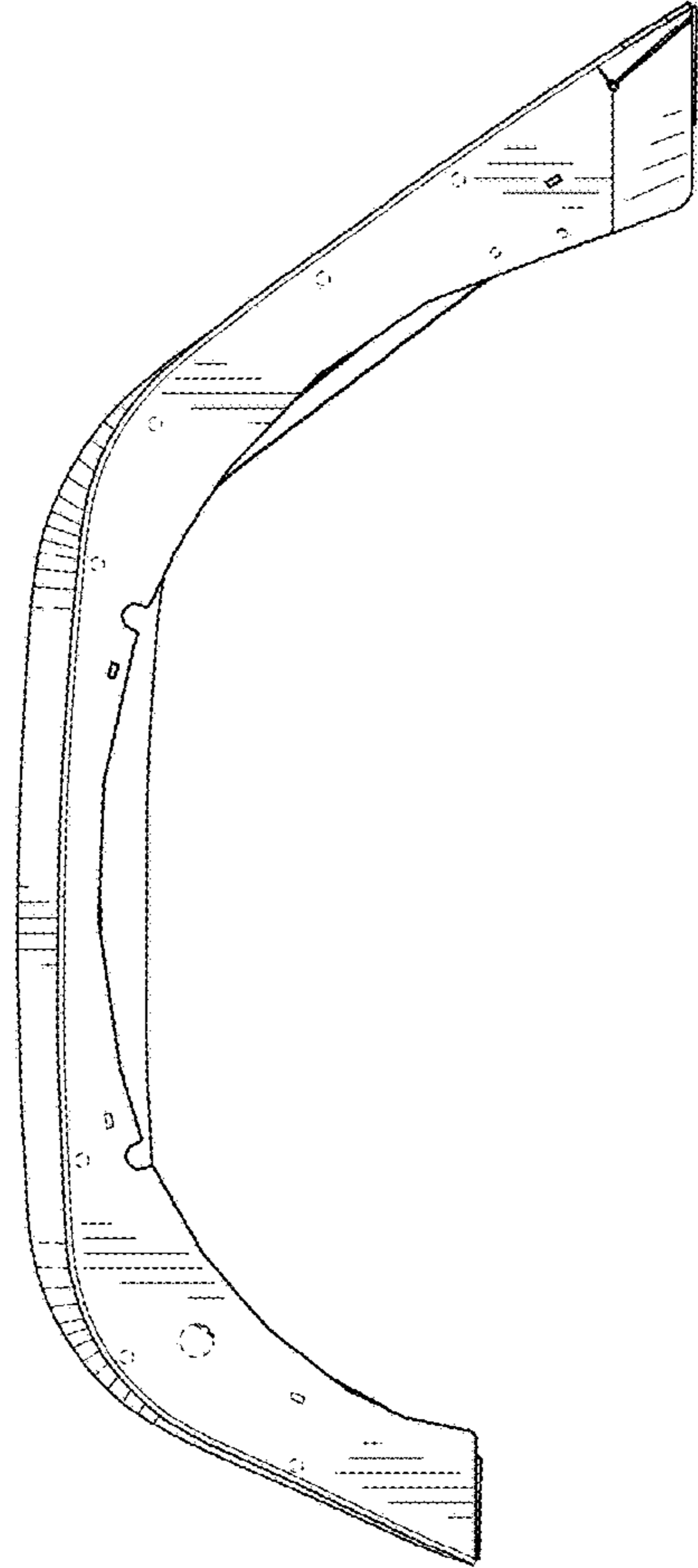

FIG. 26

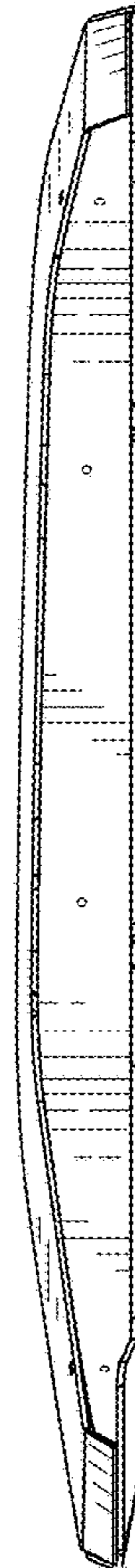

FIG. 28