



US00D858305S

(12) **United States Design Patent**
Henderson et al.

(10) **Patent No.:** **US D858,305 S**

(45) **Date of Patent:** **** Sep. 3, 2019**

(54) **REUSABLE PLAYABLE RIGID PACKAGE**

(56) **References Cited**

(71) Applicant: **The Quaker Oats Company**, Chicago, IL (US)

U.S. PATENT DOCUMENTS

(72) Inventors: **Eric Thomas Henderson**, Chicago, IL (US); **Antonio Pugliese**, Shanghai (CN); **Gianmauro Vella**, Shanghai (CN); **ZhenXian Zhao**, Shanghai (CN)

D307,772 S	*	5/1990	Takahashi	D21/428
D349,632 S	*	8/1994	Nicholson	D9/675
D436,527 S	*	1/2001	Bergersen	D9/675
D454,923 S	*	3/2002	Katz	D21/433
D506,063 S	*	6/2005	Hussa-Lietz	D3/271.12
D509,876 S	*	9/2005	Sagol	D21/816
D513,283 S	*	12/2005	Wampler	D21/433
D534,810 S	*	1/2007	Sellars	D9/675
D622,328 S	*	8/2010	Giannini	D21/433

(73) Assignee: **The Quaker Oats Company**, Chicago, IL (US)

* cited by examiner

(**) Term: **15 Years**

Primary Examiner — Sandra L Morris

(21) Appl. No.: **29/644,512**

(74) *Attorney, Agent, or Firm* — James R. Gourley; James H. Ortega; Carstens & Cahoon, LLP

(22) Filed: **Apr. 18, 2018**

(51) **LOC (12) Cl.** **09-01**

(57) **CLAIM**

(52) **U.S. Cl.**
USPC **D9/675; D21/428**

The ornamental design for a reusable playable rigid package, as shown and described.

(58) **Field of Classification Search**
USPC D3/270, 271.1–271.4; D7/510, 514–520, D7/599, 604, 613, 619.2, 623, 628; D9/600, 672–678, 414–418, 430–434; 206/457, 459.5, 527; 215/381–384, 400; D21/427, 428, 433, 548–551; D6/564, D6/665.1

DESCRIPTION

CPC B65D 5/42; B65D 5/4258; B65D 81/60; B65D 81/365; B65D 81/366; B65D 81/368; B65D 2203/00; B65D 2203/02; B65D 37/00; B65D 77/00; B65D 97/00; A63H 33/16

FIG. 1 is a front perspective view of the reusable playable rigid package;
FIG. 2 is a front elevation view of the package;
FIG. 3 is a rear elevation view of the package;
FIG. 4 is a right side elevation view of the package;
FIG. 5 is a left side elevation view of the package;
FIG. 6 is a top view of the package; and,
FIG. 7 is a bottom plan view of thereof.

See application file for complete search history.

1 Claim, 6 Drawing Sheets

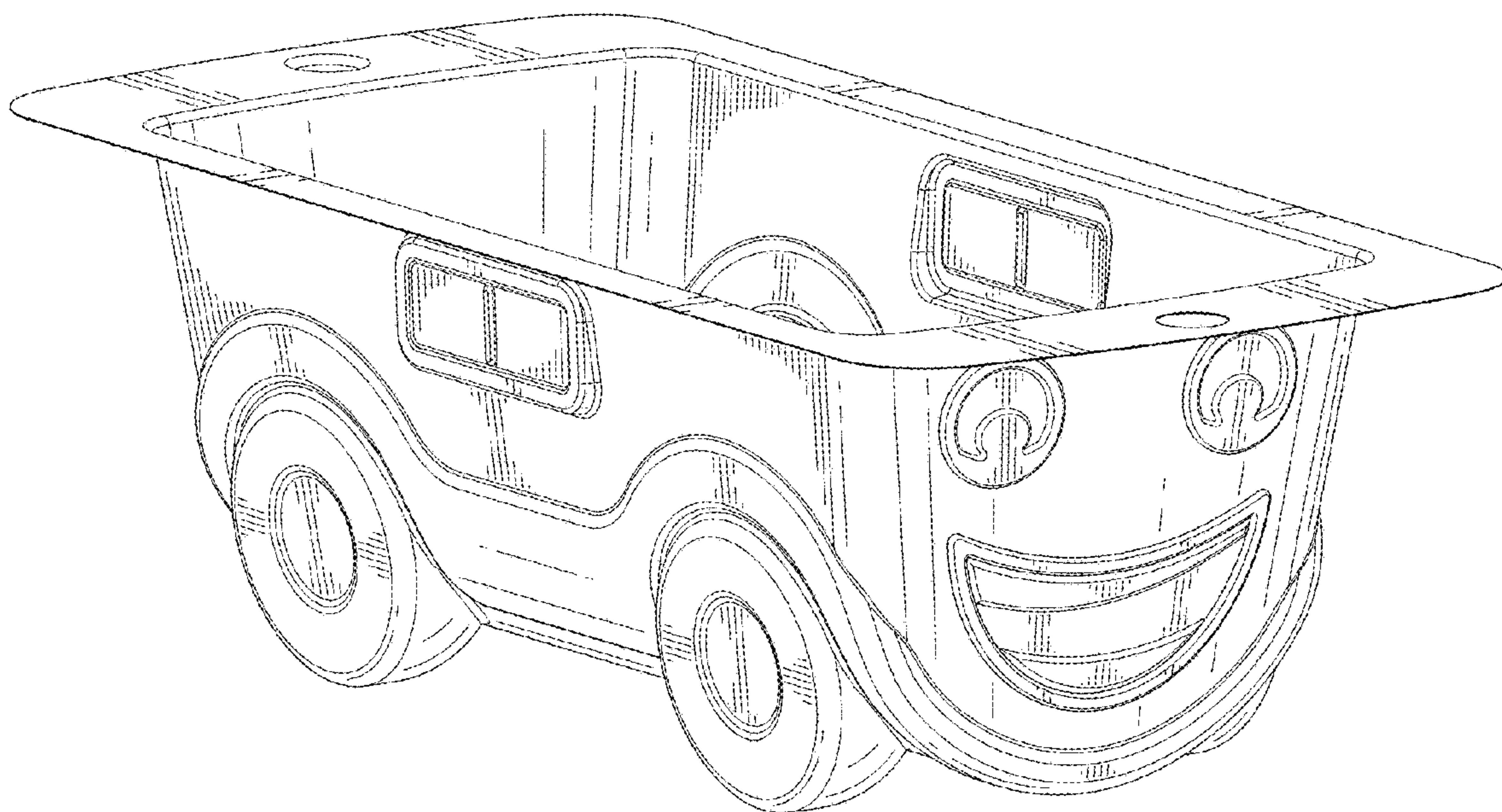

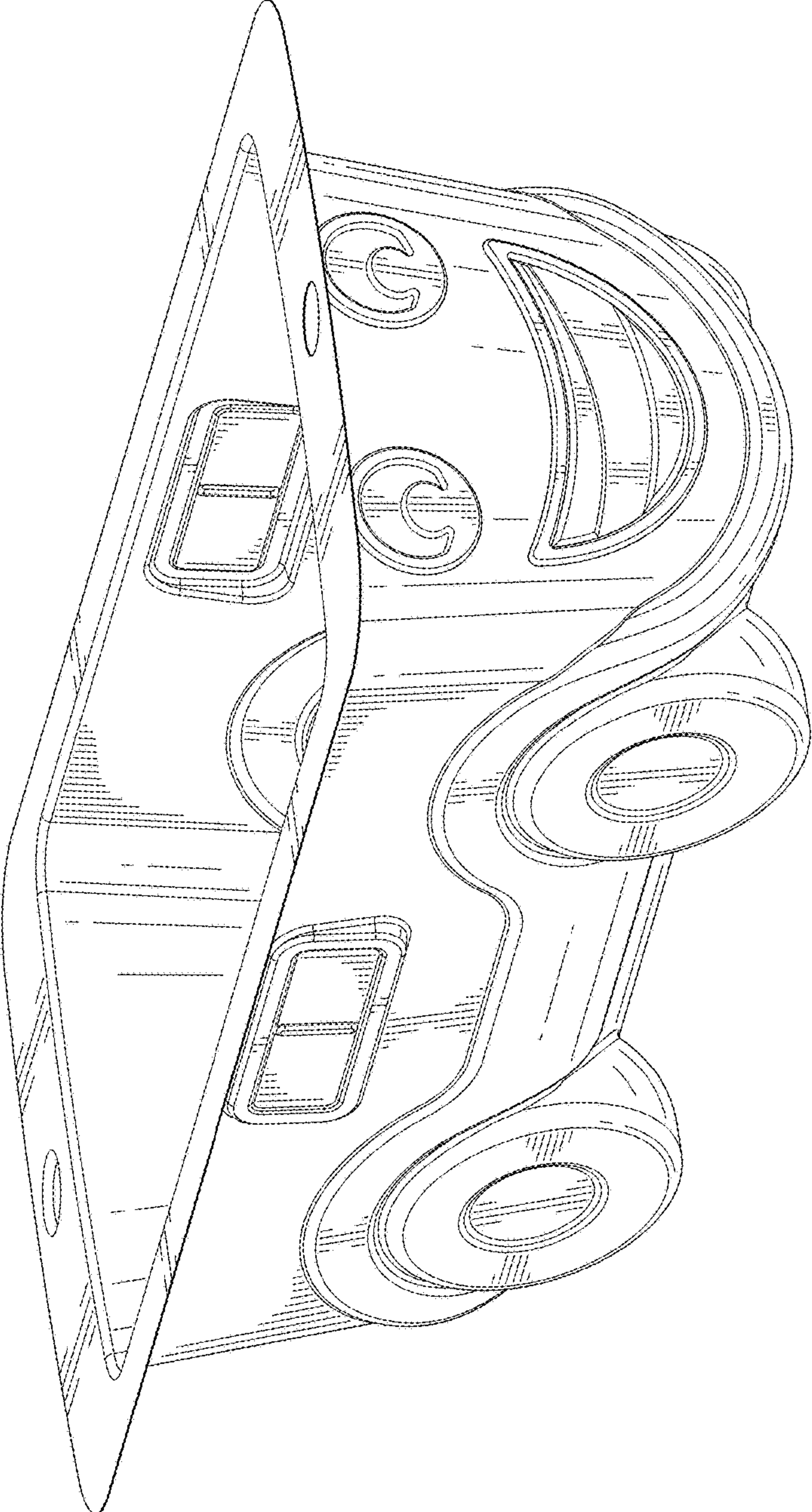

FIG. 1

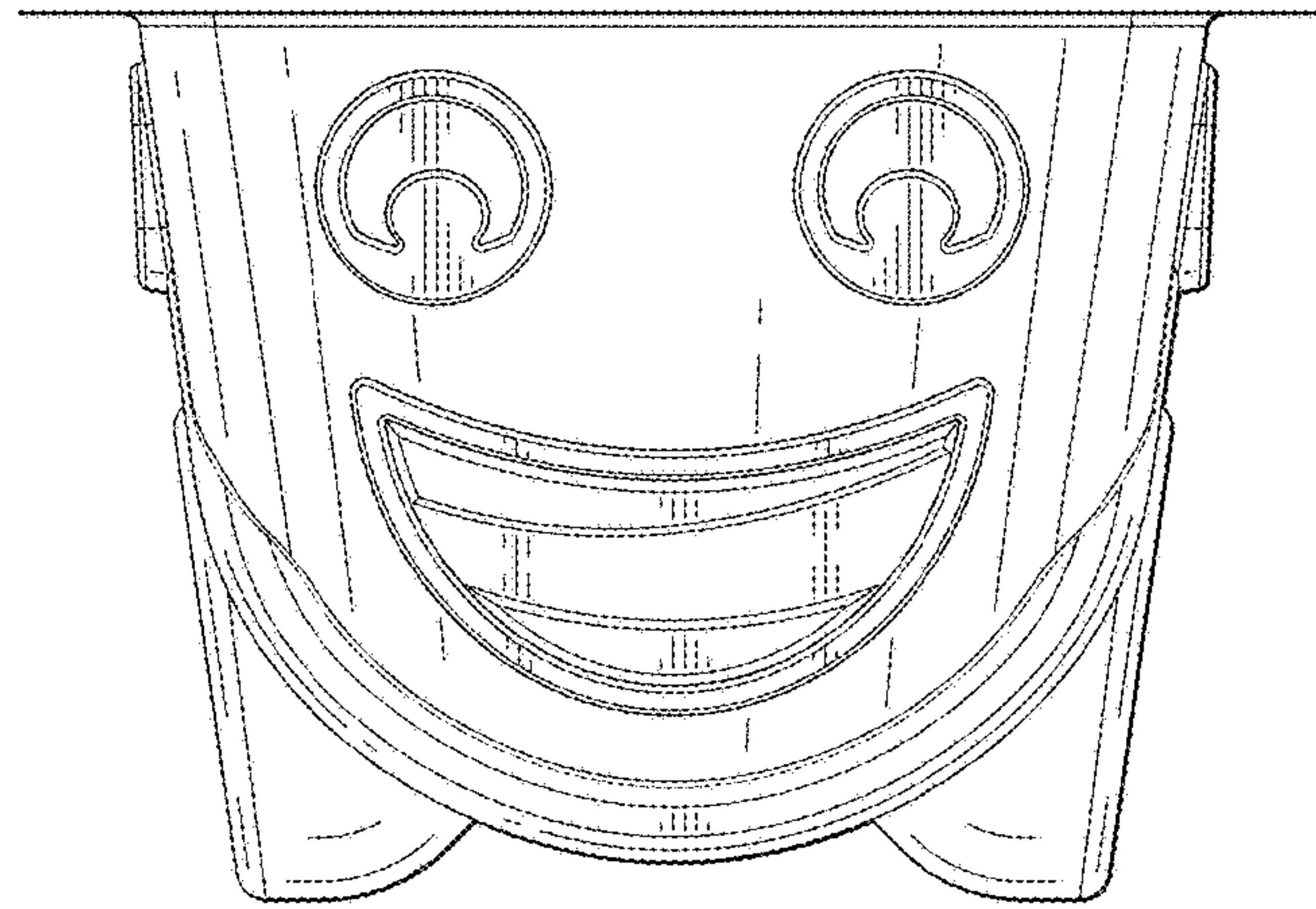

FIG. 2

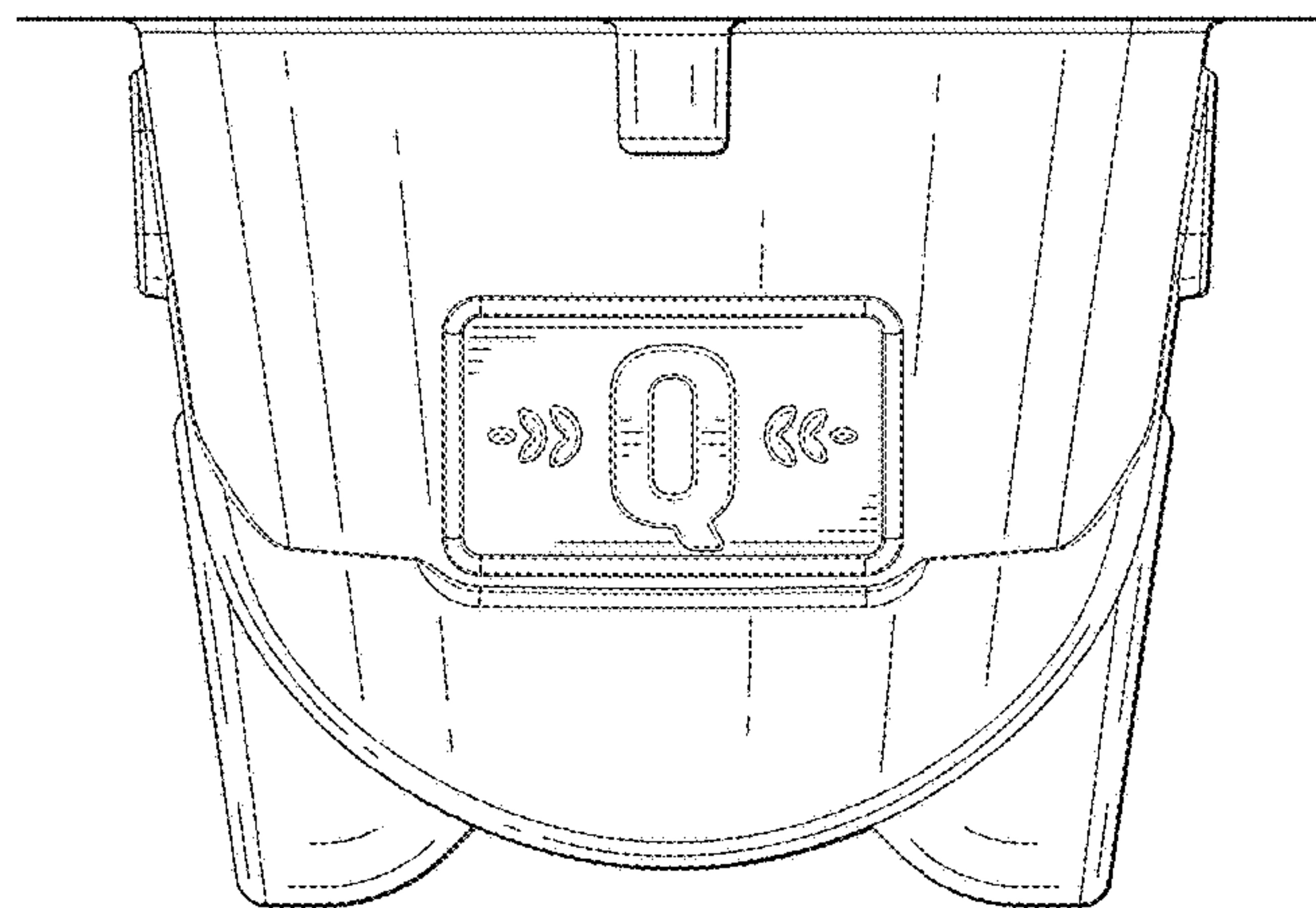

FIG. 3

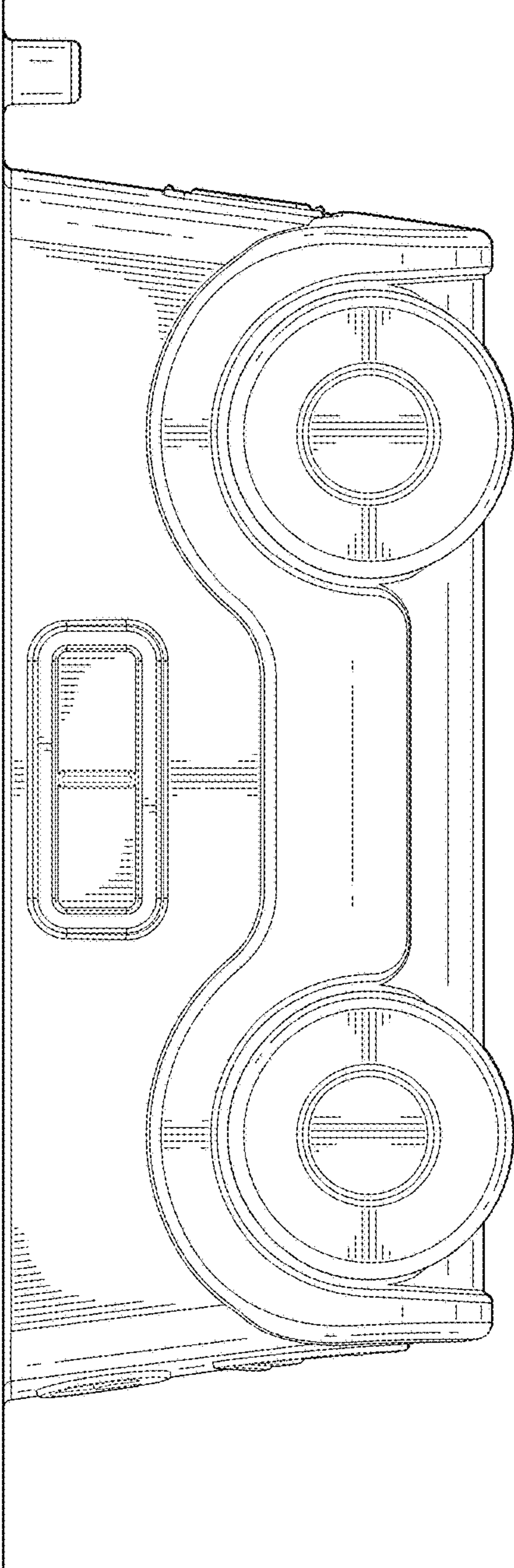

FIG. 4

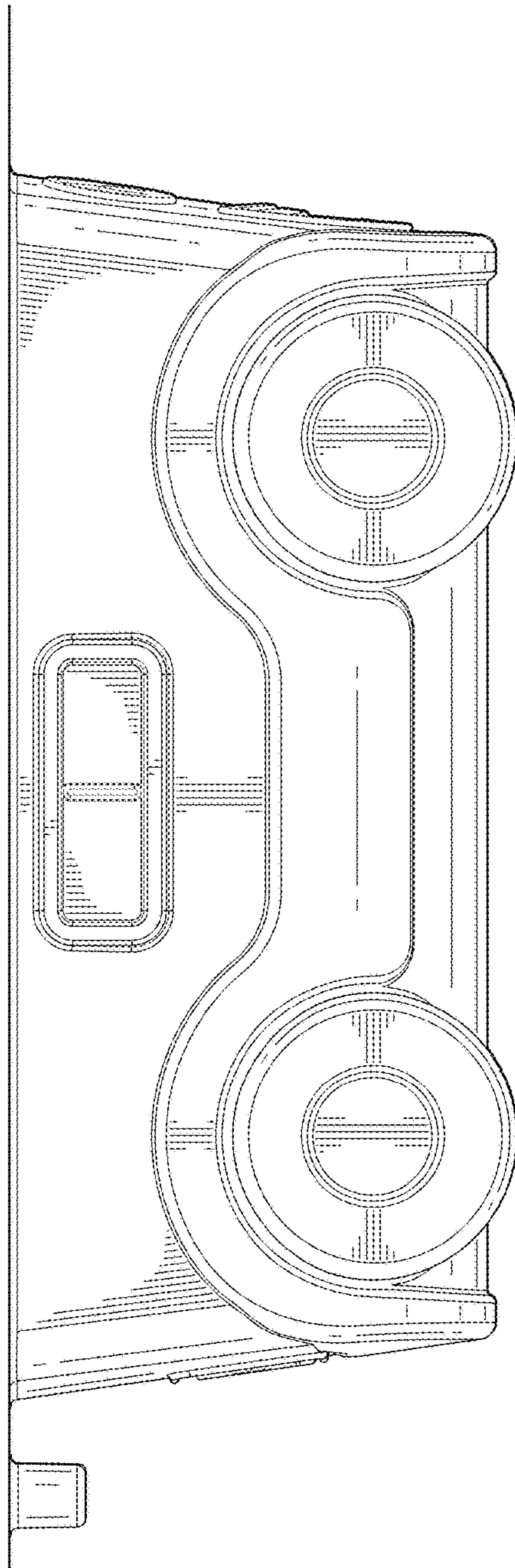

FIG. 5

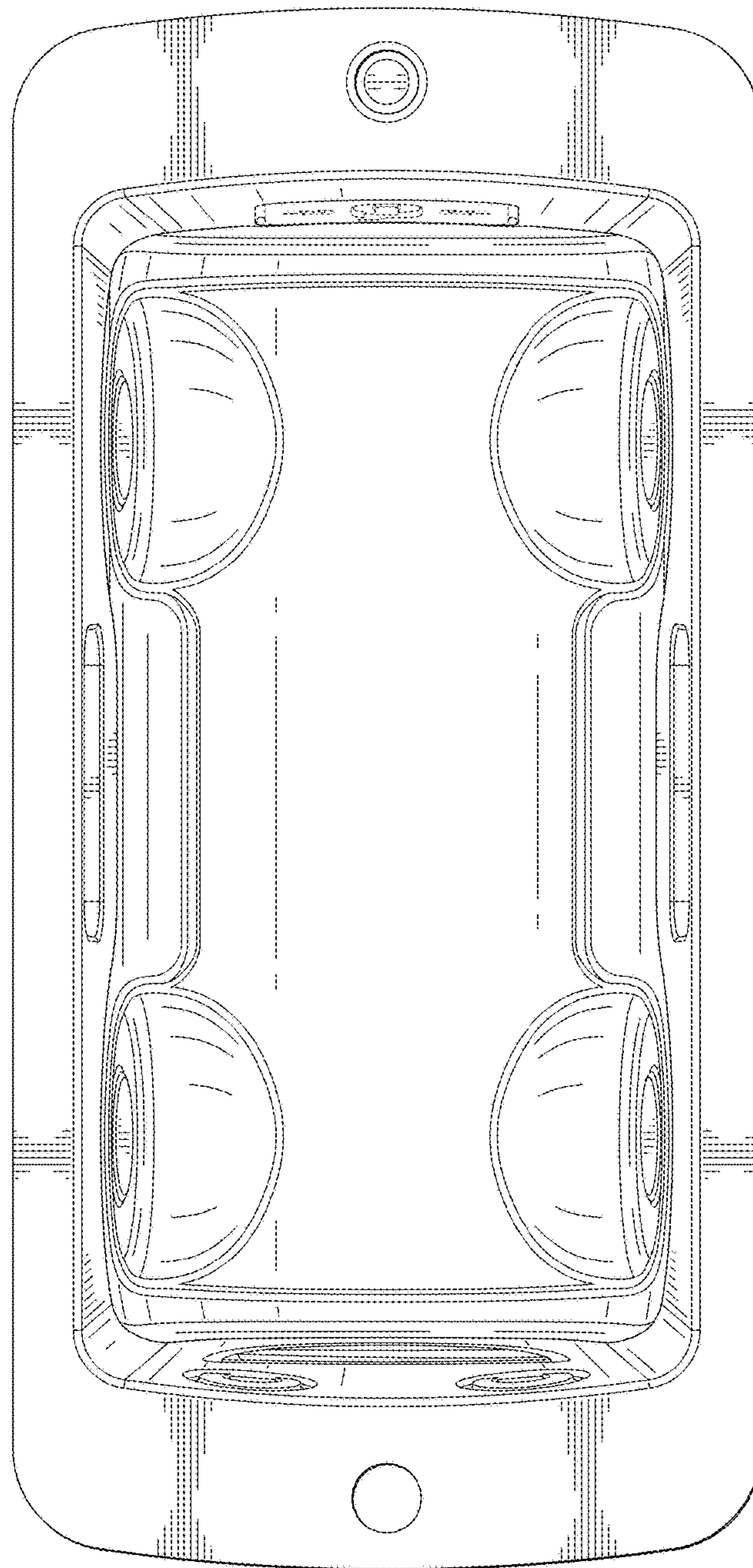

FIG. 6

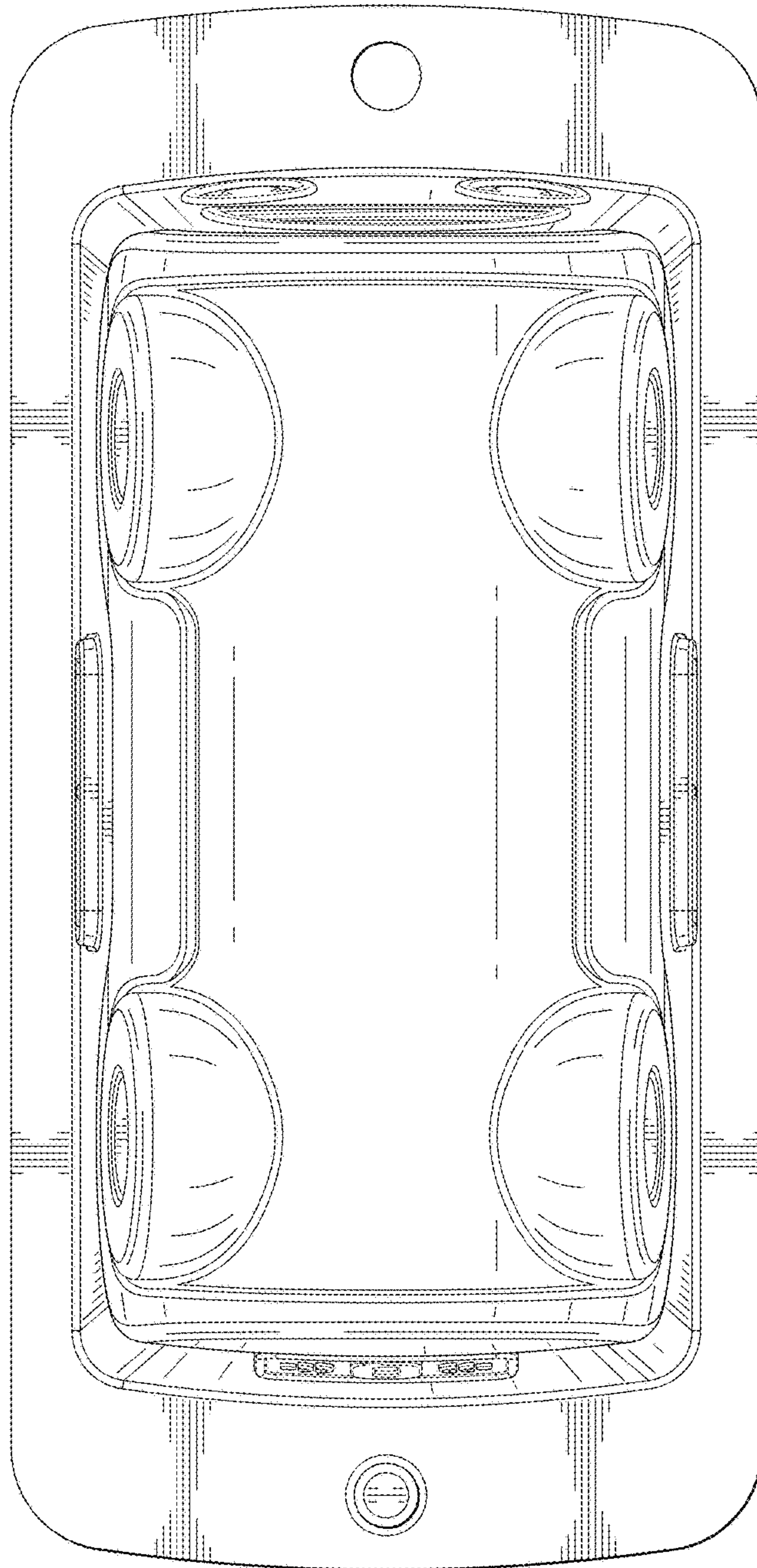

FIG. 7