



US00D858243S

(12) **United States Design Patent** (10) **Patent No.:** **US D858,243 S**
Honadel et al. (45) **Date of Patent:** **** Sep. 3, 2019**

- (54) **DEMOLITION TOOL**
- (71) Applicant: **Fiskars Brands, Inc.**, Middleton, WI (US)
- (72) Inventors: **Aaron Honadel**, Verona, WI (US);
Colin Roberts, Madison, WI (US);
Steve Stokes, Fitchburg, WI (US)
- (73) Assignee: **Fiskars Brands, Inc.**, Middleton, WI (US)
- (**) Term: **15 Years**
- (21) Appl. No.: **29/649,617**
- (22) Filed: **May 31, 2018**

- 5,428,853 A 7/1995 Menke et al.
- D390,082 S 2/1998 Higgs
- 5,850,650 A 12/1998 Karsnia
- D449,770 S 10/2001 Chen
- D507,167 S 7/2005 Richardson
- 7,066,052 B2 6/2006 Chen
- D562,101 S 2/2008 Martone et al.
- D567,620 S 4/2008 Martone et al.
- D572,106 S 7/2008 Chen
- D577,273 S 9/2008 Chen
- D577,274 S 9/2008 Chen
- D577,978 S 10/2008 Chen
- D588,894 S 3/2009 Chen
- D590,230 S 4/2009 Martone et al.
- D595,555 S 7/2009 Vanderbeek
- D605,020 S 12/2009 Martone et al.
- D626,396 S 11/2010 Gehman et al.

(Continued)

Primary Examiner — Philip S Hyder
(74) *Attorney, Agent, or Firm* — Leason Ellis LLP

Related U.S. Application Data

- (62) Division of application No. 29/575,880, filed on Aug. 30, 2016, now Pat. No. Des. 821,841.
- (51) **LOC (12) Cl.** **08-02**
- (52) **U.S. Cl.**
USPC **D8/81**
- (58) **Field of Classification Search**
USPC D8/75, 76, 77, 78, 79, 80, 81
CPC ... B25D 1/00; B25D 1/02; B25D 1/04; B25D 1/045; B25D 1/06; B25D 1/12; B25G 1/01; B25G 1/02; B25G 1/102; B25F 1/00
See application file for complete search history.

(57) **CLAIM**

We claim the ornamental design for a demolition tool, as shown and described.

DESCRIPTION

FIG. 1 is a front perspective view of an embodiment of the claimed design;
 FIG. 2 is a right side view thereof;
 FIG. 3 is a left side view thereof;
 FIG. 4 is a front view thereof
 FIG. 5 is a rear view thereof;
 FIG. 6 is a top view thereof; and,
 FIG. 7 is a bottom view thereof.
 Any portion of the article depicted in broken lines forms no part of the claimed design. Broken lines formed by equal length dashes show unclaimed subject matter. Broken lines formed of unequal length dashes (i.e., dash-dot) show boundaries between claimed and unclaimed portions of the design. Broken lines having a jagged element show that no particular length of the portion is claimed.

1 Claim, 5 Drawing Sheets

(56) **References Cited**
U.S. PATENT DOCUMENTS

- 4,155 A 8/1845 Anderson
- 499,322 A 6/1893 Heckert
- 513,271 A 1/1894 Matthews
- 1,469,472 A 10/1923 Bangert
- 3,219,316 A 11/1965 Fried
- 3,705,430 A 12/1972 Ziaylek, Jr.
- D300,111 S 3/1989 Square

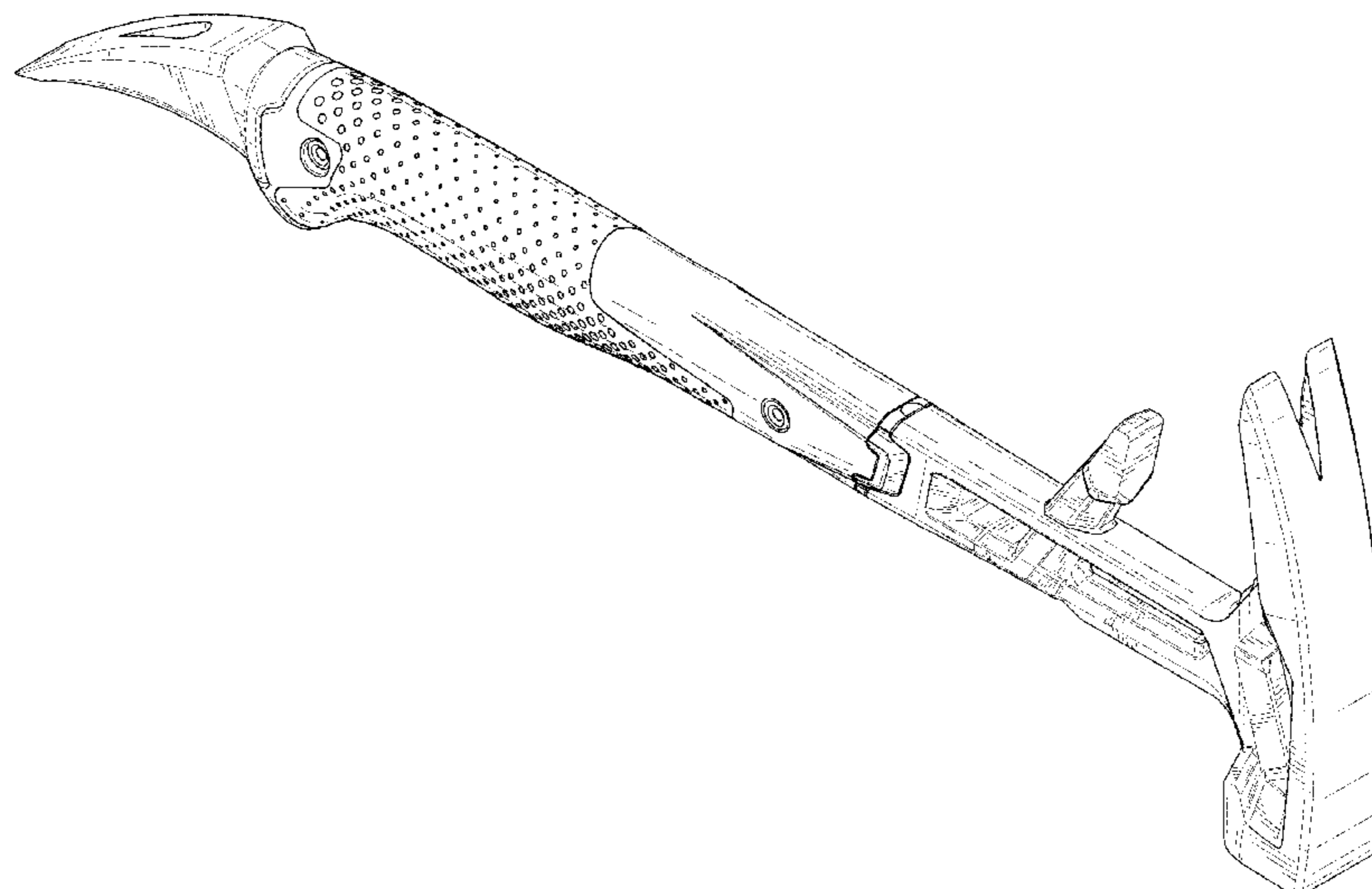

(56)

References Cited

U.S. PATENT DOCUMENTS

7,874,231	B2	1/2011	Hanlon
D637,058	S	5/2011	Gehman et al.
8,024,994	B2	9/2011	St John et al.
8,056,443	B2	11/2011	Hanlon
8,117,702	B2	2/2012	Woolley et al.
8,387,486	B2	3/2013	Hanlon
8,458,838	B2	6/2013	Trice
8,585,016	B2	11/2013	Woolley et al.
8,661,592	B2	3/2014	Trice
8,770,548	B2	7/2014	Hanlon
8,914,929	B2	12/2014	Hanlon
D747,943	S	1/2016	Hung
D752,940	S	4/2016	Deng et al.
D770,254	S	11/2016	Honadel et al.
D770,875	S	11/2016	Honadel et al.
D789,760	S	6/2017	Hung
2009/0271929	A1	11/2009	Adams et al.
2010/0043149	A1	2/2010	Chen

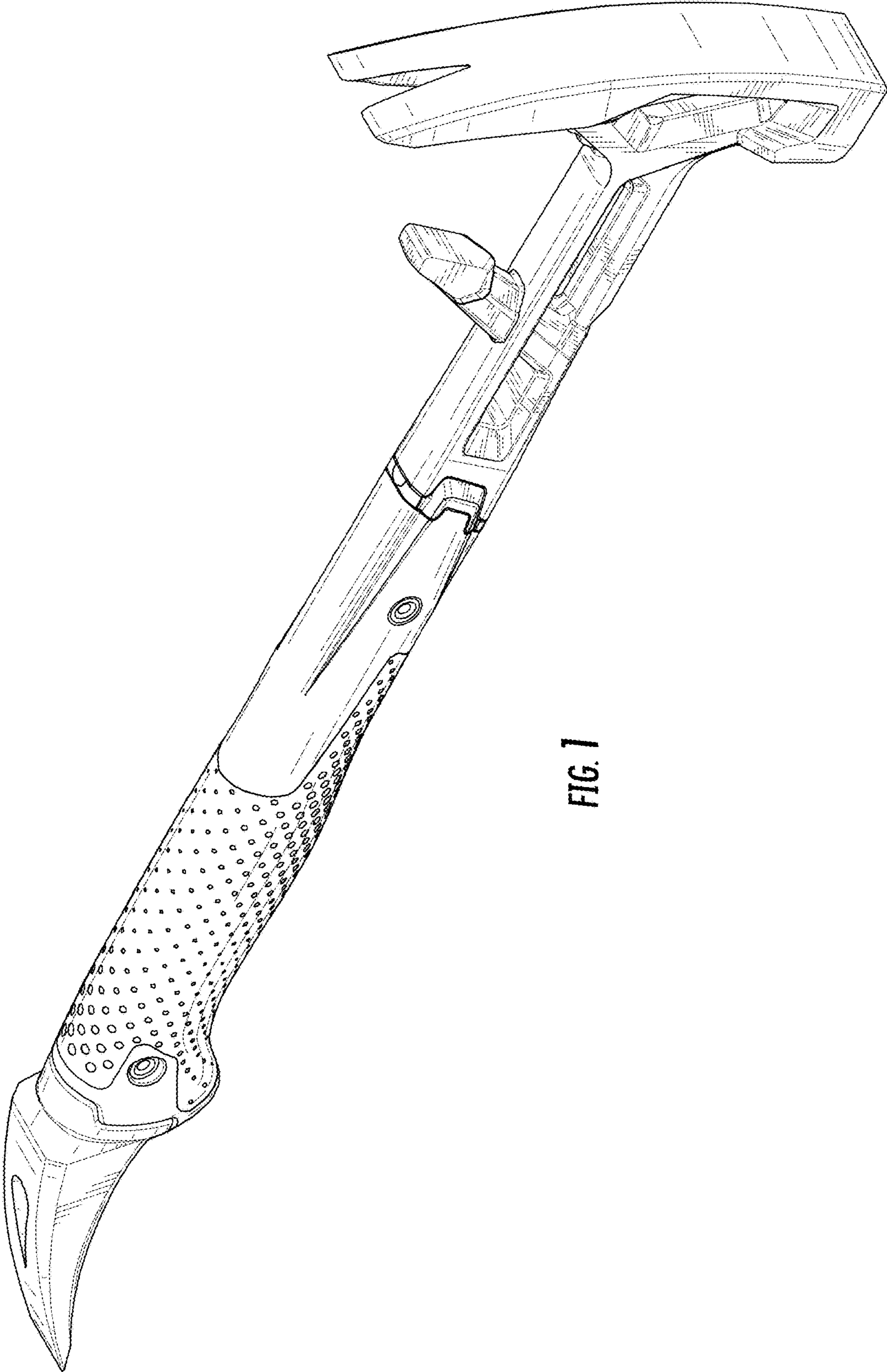

FIG. 1

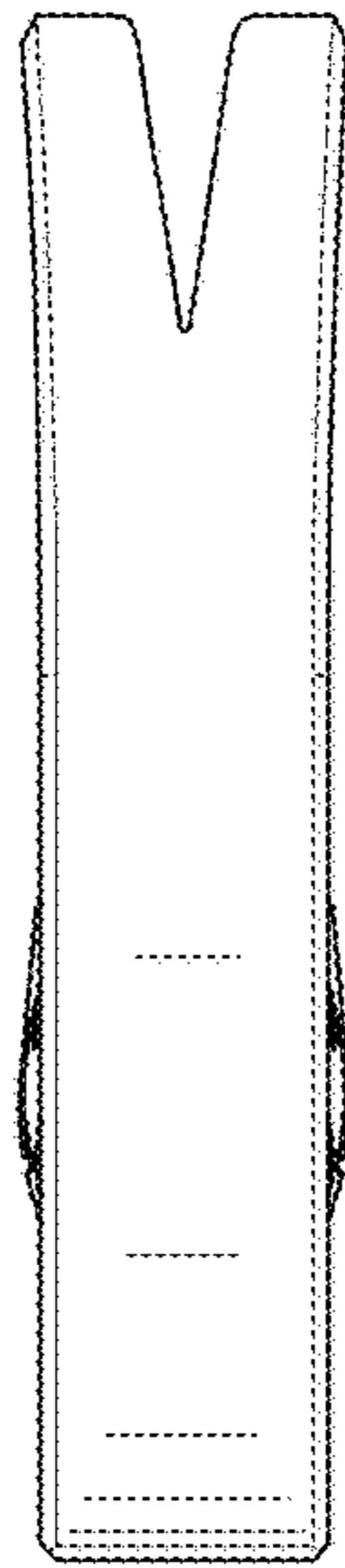

FIG. 2

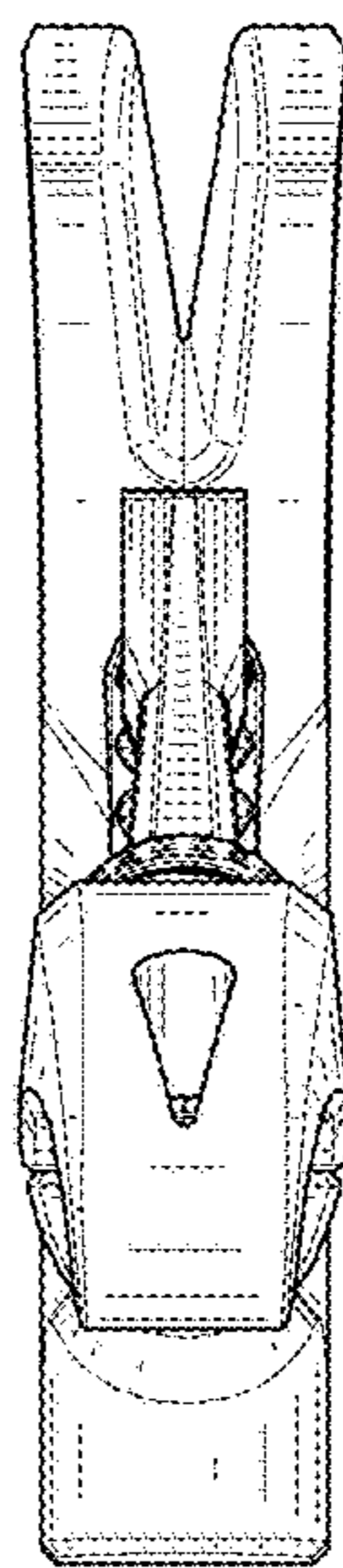

FIG. 3

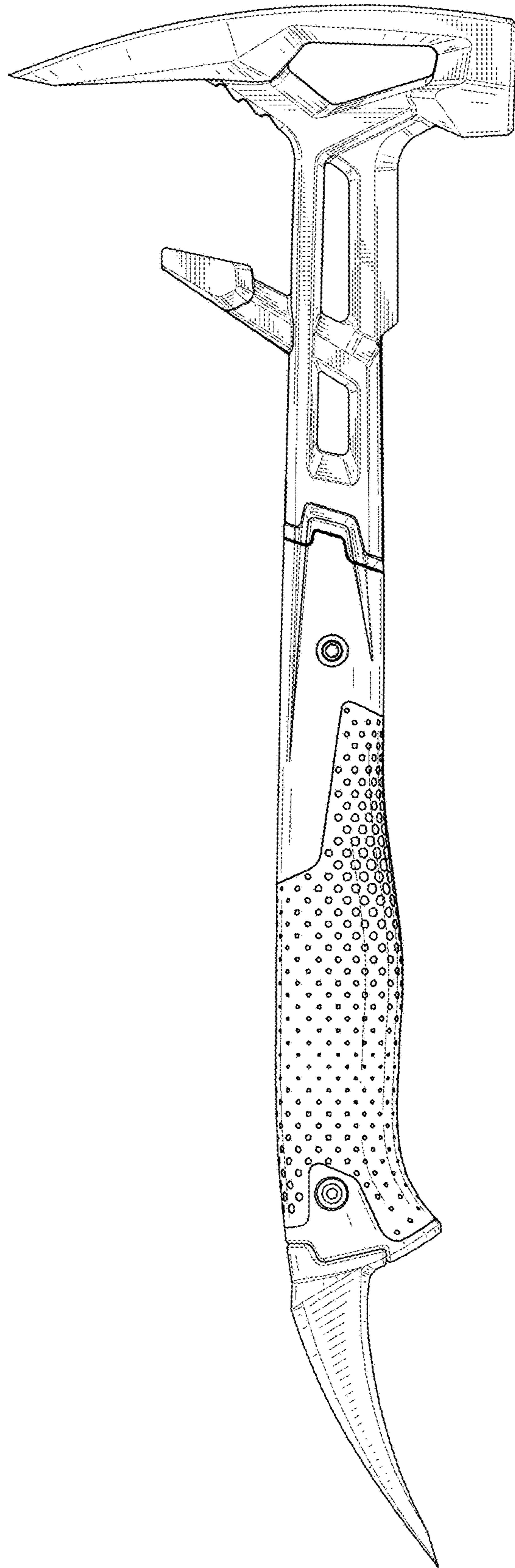

FIG. 4

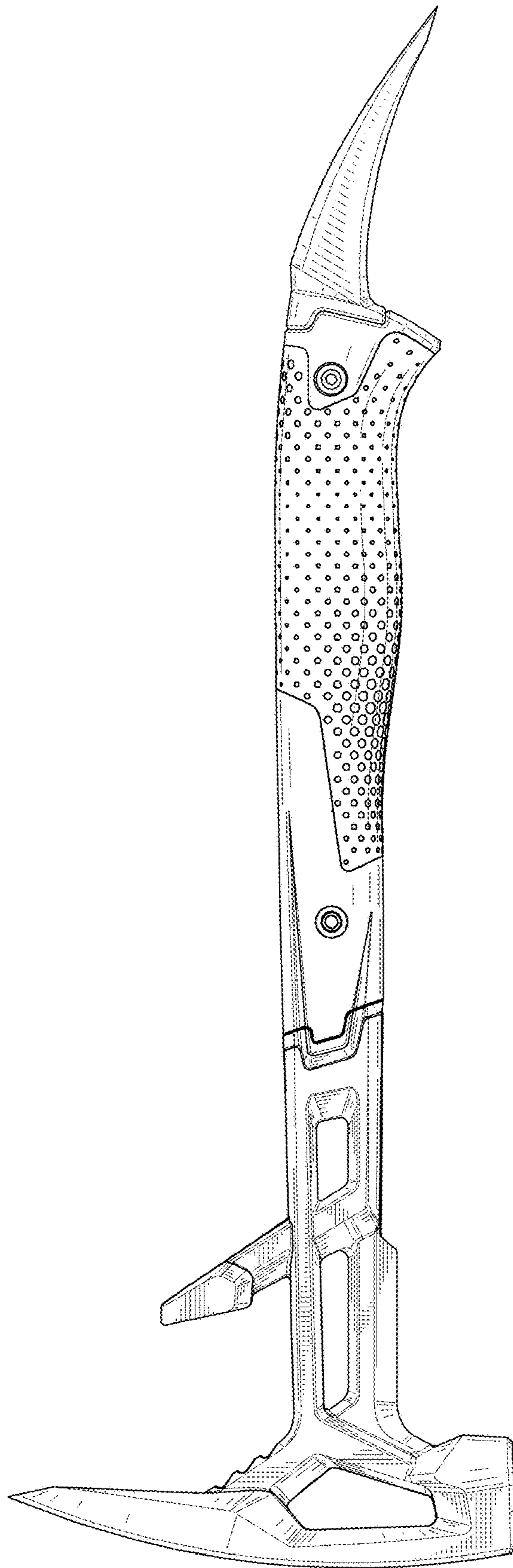

FIG. 5

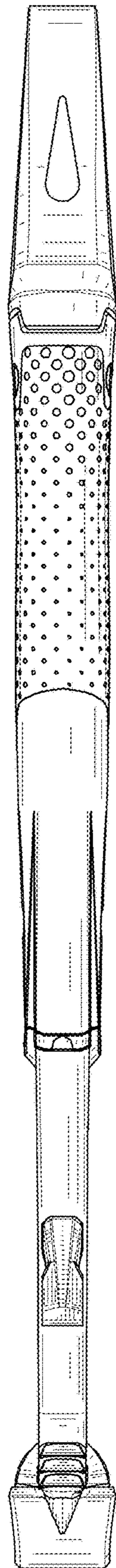

FIG. 6

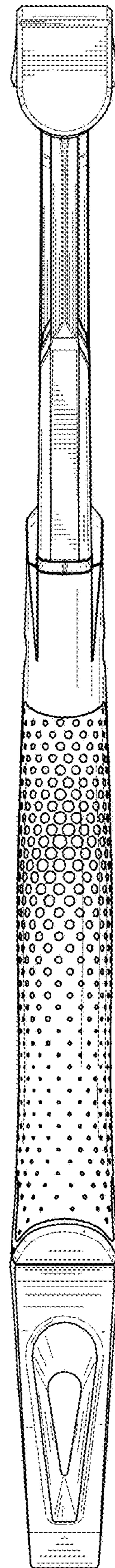

FIG. 7