



US00D858104S

(12) **United States Design Patent**
Maki et al.

(10) **Patent No.:** **US D858,104 S**

(45) **Date of Patent:** **** Sep. 3, 2019**

(54) **GOLF BAG TOP**

D654,268 S * 2/2012 Boncimino D3/255
D669,266 S * 10/2012 Loudenslager D3/255
D715,055 S * 10/2014 Bruce D3/255

(71) Applicant: **Callaway Golf Company**, Carlsbad,
CA (US)

* cited by examiner

(72) Inventors: **Christian D. Maki**, San Diego, CA
(US); **Emily Doberstein**, San Diego,
CA (US)

Primary Examiner — Holly H Baynham

(74) *Attorney, Agent, or Firm* — Rebecca Hanovice;
Michael Catania; Sonia Lari

(73) Assignee: **Callaway Golf Company**, Carlsbad,
CA (US)

(**) Term: **15 Years**

(57) **CLAIM**

(21) Appl. No.: **29/656,753**

The ornamental design for a golf bag top, as shown and described.

(22) Filed: **Jul. 16, 2018**

(51) **LOC (12) Cl.** **03-01**

(52) **U.S. Cl.**
USPC **D3/318; D3/255**

DESCRIPTION

(58) **Field of Classification Search**
USPC D3/255, 318
CPC A47F 7/0021; A63B 55/00; A63B 71/00
See application file for complete search history.

FIG. 1 is a top perspective view of the golf bag top claimed herein;

FIG. 2 is a front elevational view thereof;

FIG. 3 is a rear elevational view thereof;

FIG. 4 is a left side elevational view thereof;

FIG. 5 is a top plan view thereof; and,

FIG. 6 is a bottom plan view thereof.

The broken lines are included for the purpose of illustration and form no part of the claimed design.

(56) **References Cited**

U.S. PATENT DOCUMENTS

6,712,206 B2 * 3/2004 Chen A63B 55/57
206/315.7
D501,604 S * 2/2005 Kadoya D3/255

1 Claim, 5 Drawing Sheets

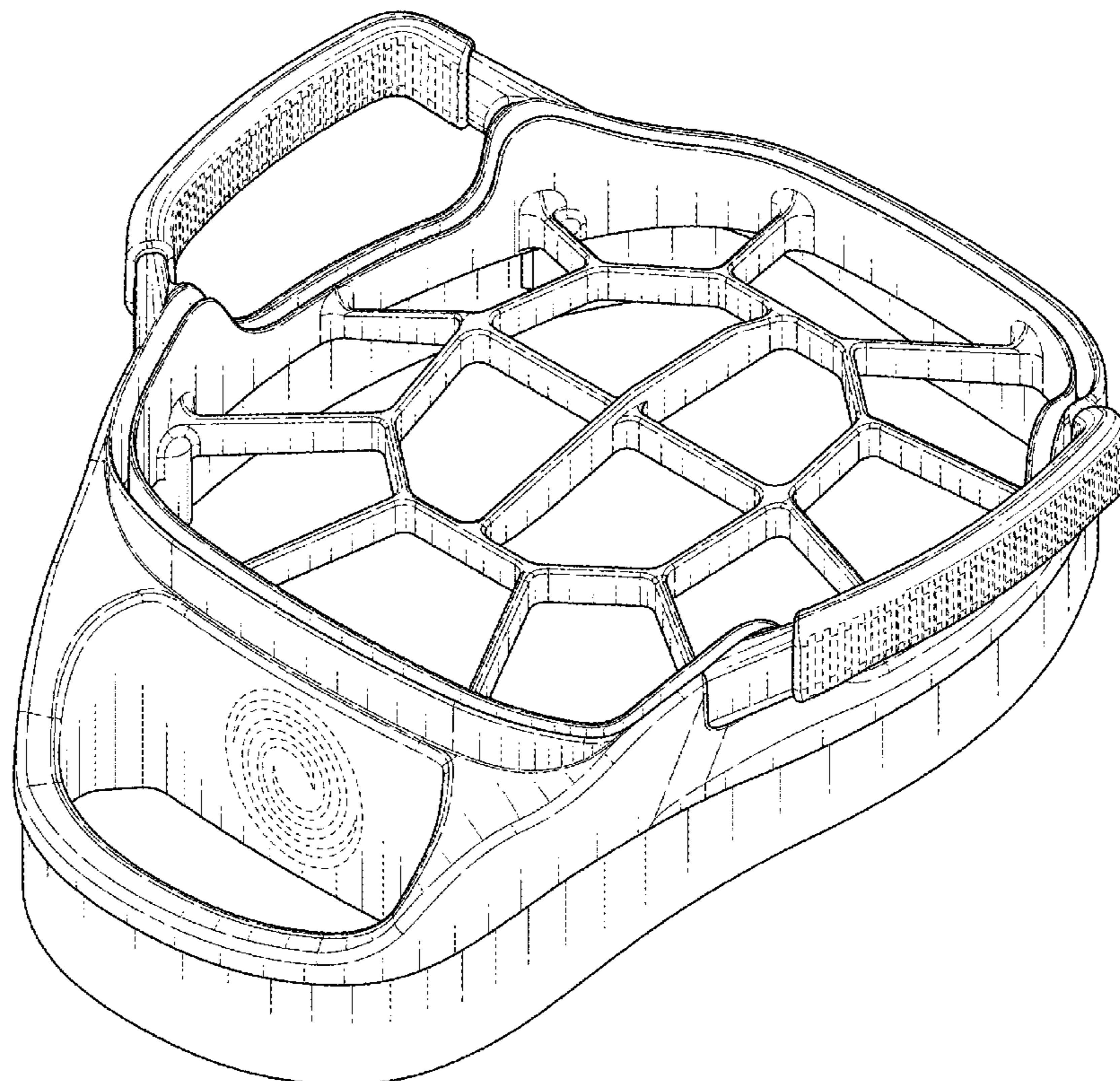

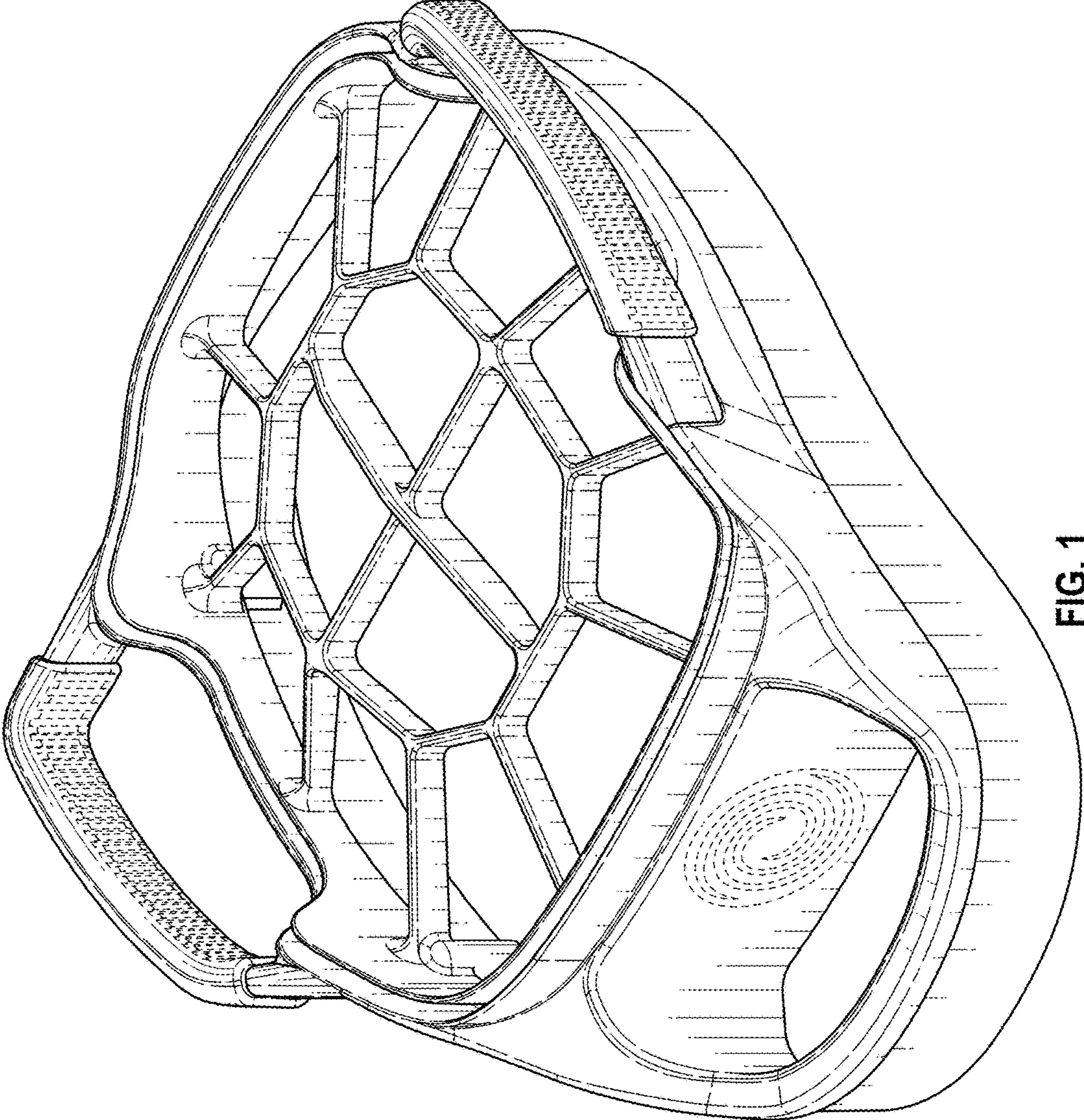

FIG. 1

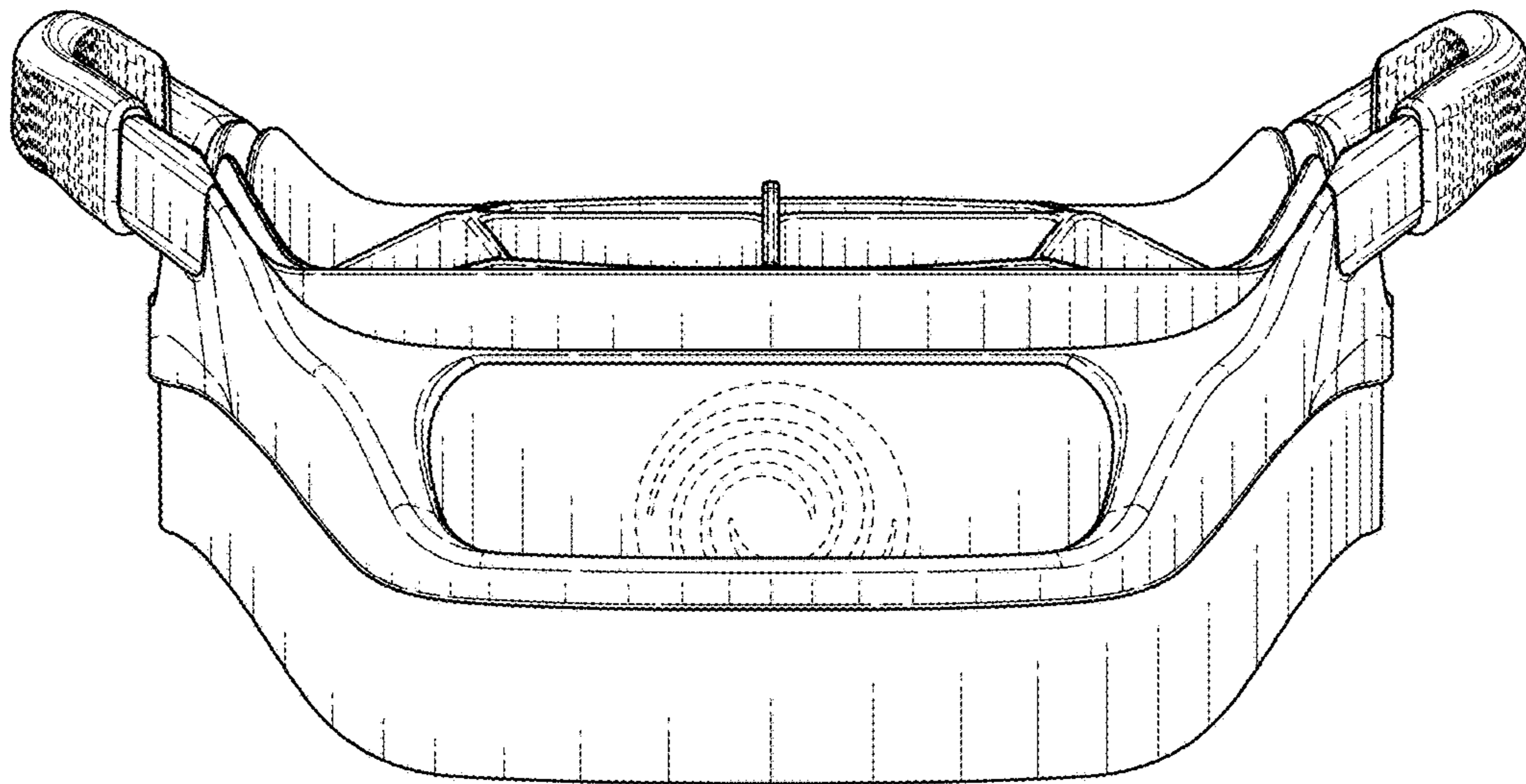

FIG. 2

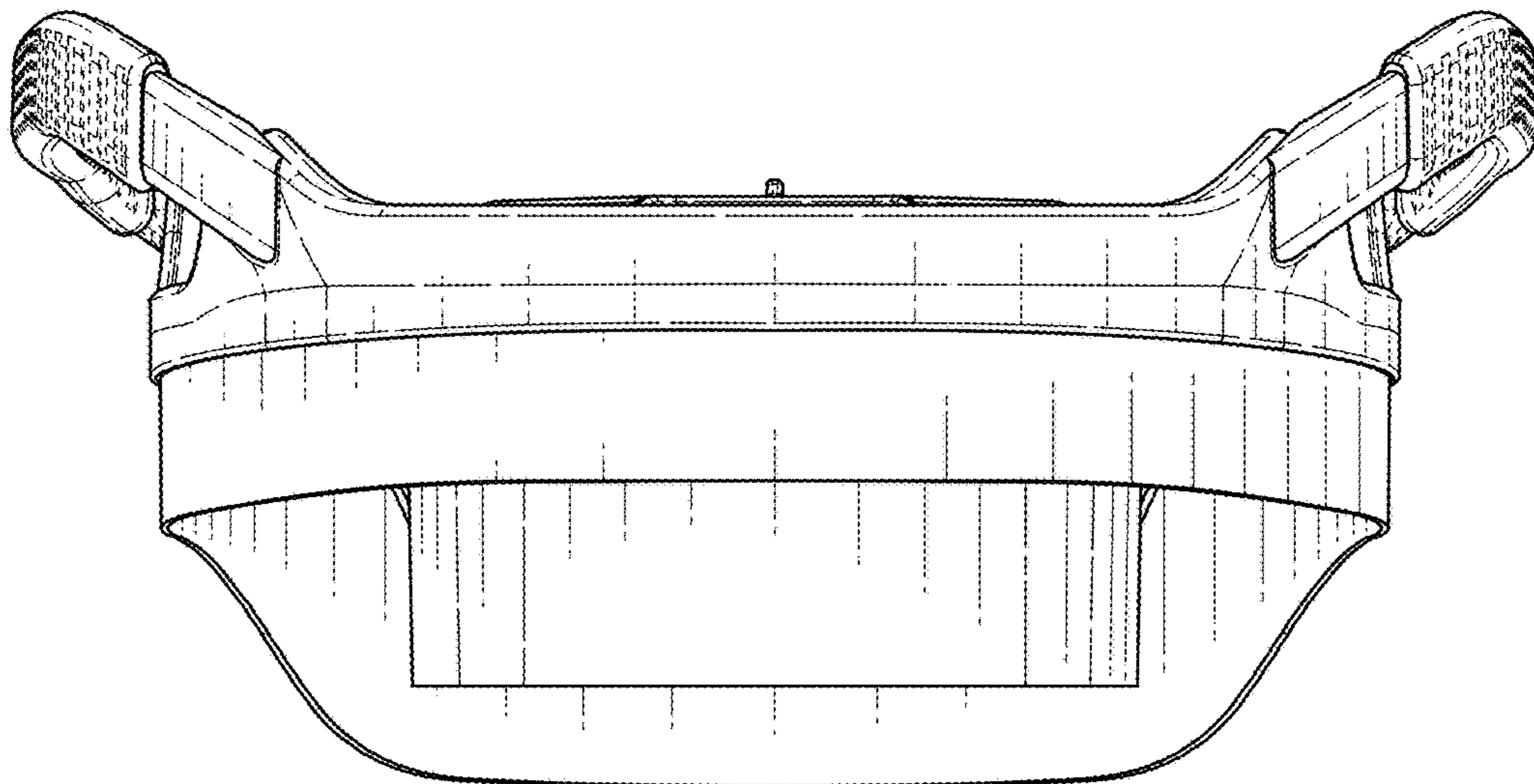

FIG. 3

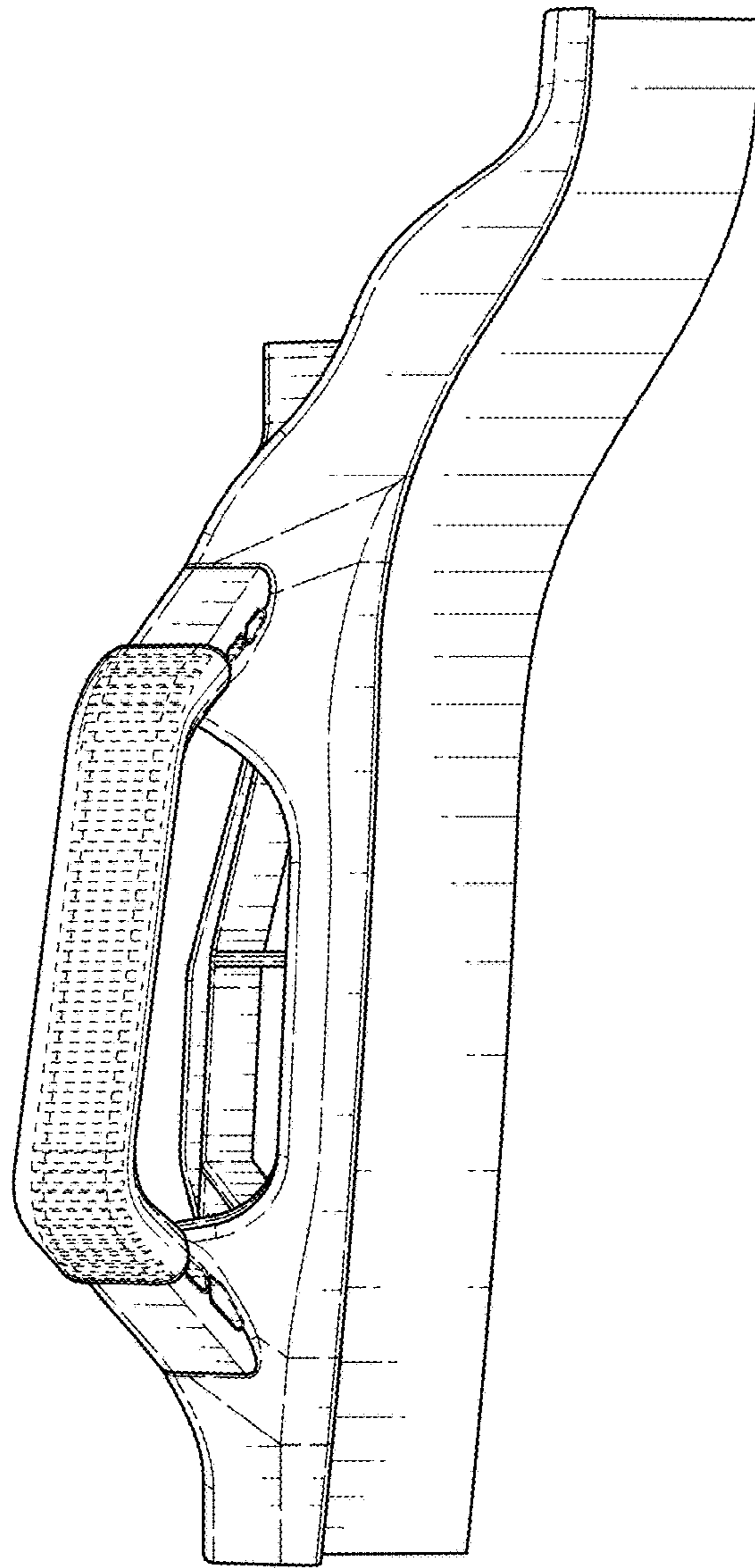

FIG. 4

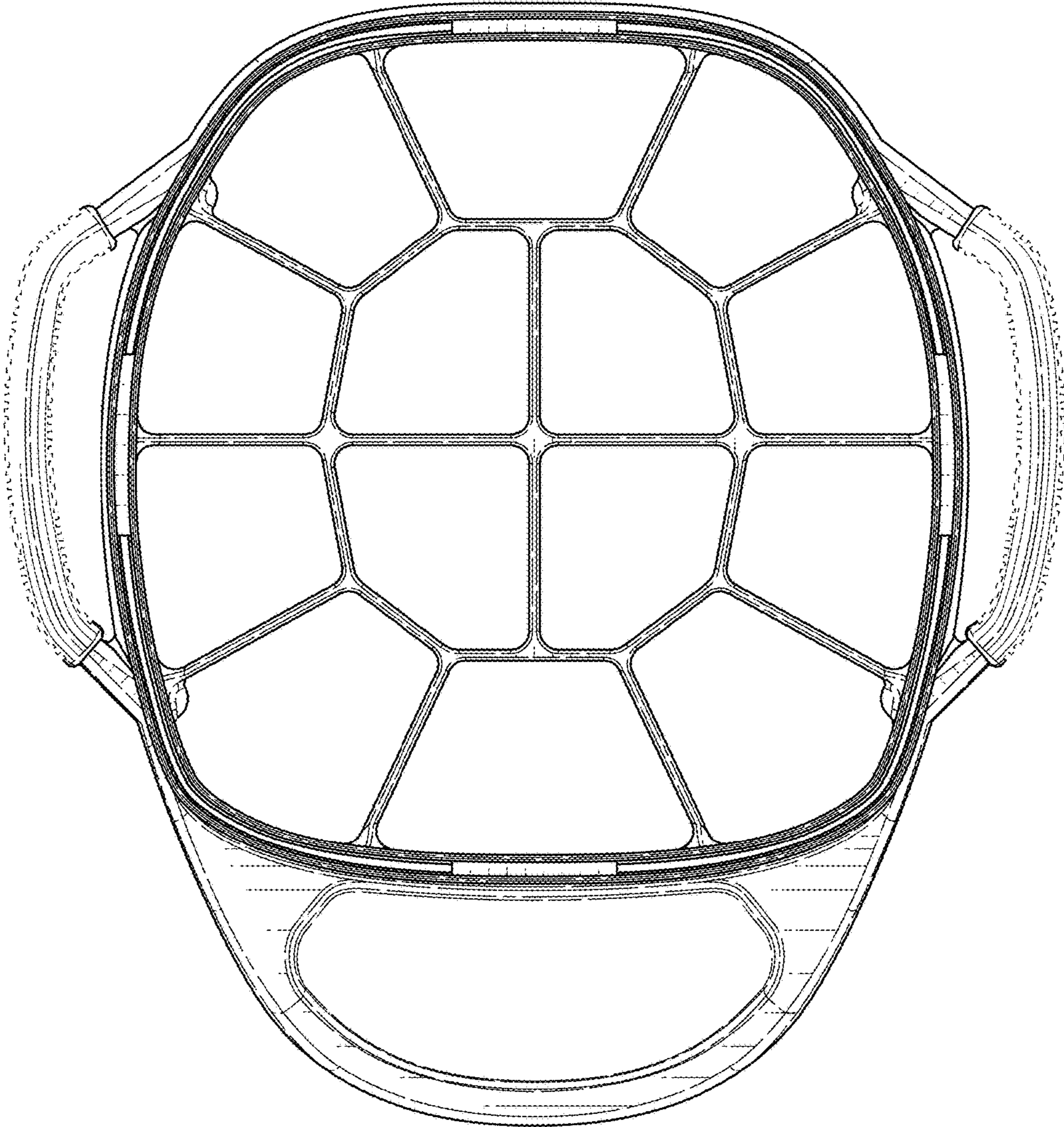

FIG. 5

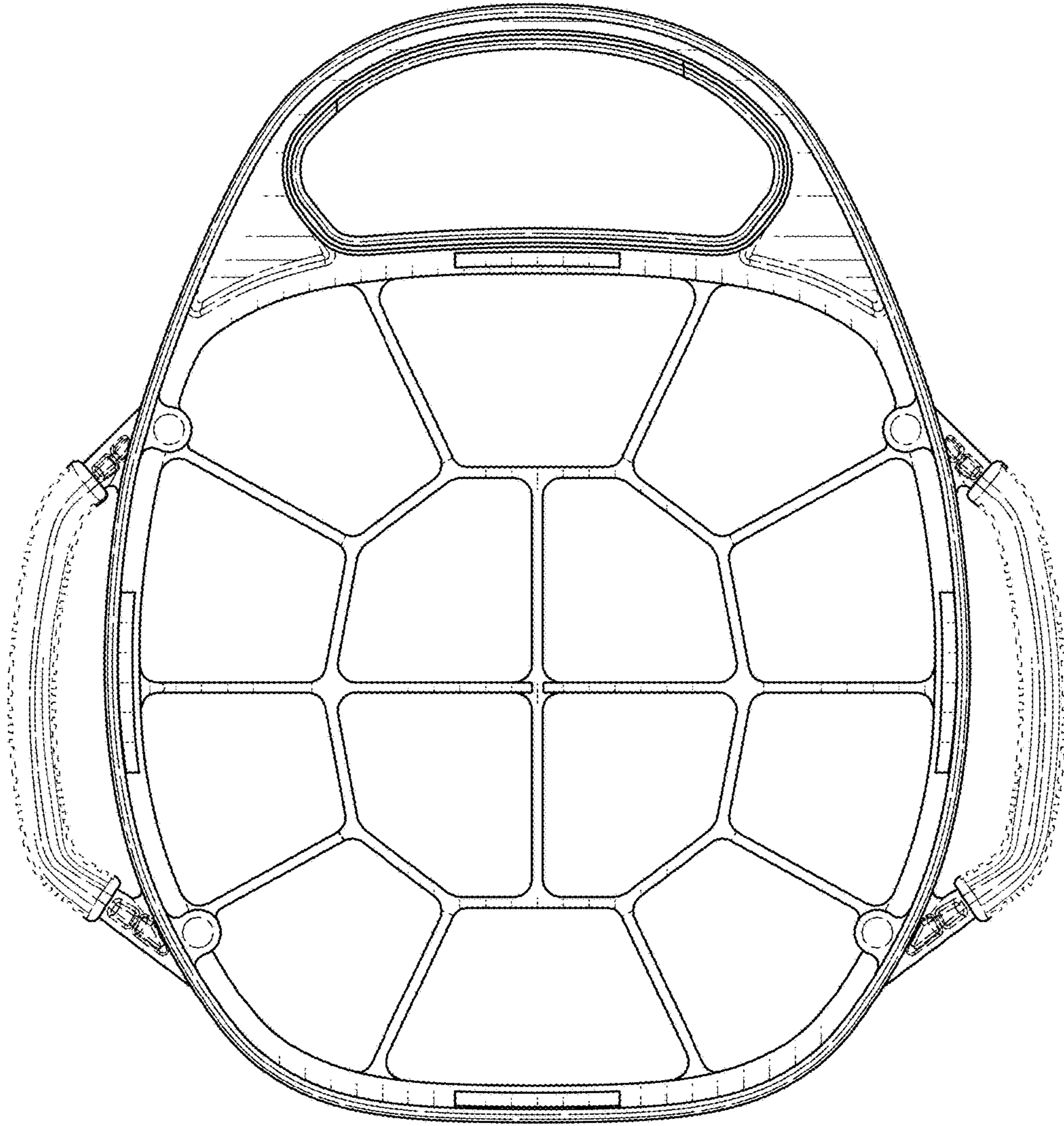

FIG. 6