



US00D857998S

(12) **United States Design Patent**  
**Turkbas**

(10) **Patent No.:** **US D857,998 S**

(45) **Date of Patent:** **\*\* Aug. 27, 2019**

(54) **MOUTHGUARD**

(71) Applicant: **Shock Doctor, Inc.**, Minnetonka, MN  
(US)

(72) Inventor: **Jay N. Turkbas**, Huntington Beach, CA  
(US)

(73) Assignee: **Shock Doctor, Inc.**, Fountain Valley,  
CA (US)

(\*\*) Term: **15 Years**

(21) Appl. No.: **29/670,232**

(22) Filed: **Nov. 14, 2018**

**Related U.S. Application Data**

(62) Division of application No. 29/579,578, filed on Sep.  
30, 2016, now Pat. No. Des. 834,258.

(51) **LOC (12) Cl.** ..... **29-02**

(52) **U.S. Cl.**  
USPC ..... **D29/108**

(58) **Field of Classification Search**  
USPC ..... D29/100, 105, 106, 108, 122; D24/181,  
D24/108-110.5, 156, 176; D5/1, 2, 56,  
D5/6; D25/100, 138, 152  
(Continued)

(56) **References Cited**

**U.S. PATENT DOCUMENTS**

3,207,153 A \* 9/1965 Goldstein ..... A63B 71/085  
128/862  
3,247,844 A \* 4/1966 Berghash ..... A63B 71/085  
128/862

(Continued)

**OTHER PUBLICATIONS**

Shock Doctor Women's SuperFit Basketball Mouthguard, no date  
available, [online], [site visited Mar. 18, 2019]. Retrieved from url:

<https://www.dickssportinggoods.com/p/shock-doctor-womens-superfit-basketball-mouthguard-17skrwsprftbllwmspm/17skrwsprftb-bllwmspm> (Year: 2019).\*

*Primary Examiner* — Cathron C Brooks

*Assistant Examiner* — Tracey J Bell

(74) *Attorney, Agent, or Firm* — Faegre Baker Daniels  
LLP

(57) **CLAIM**

The ornamental design for a mouthguard, as shown and  
described.

**DESCRIPTION**

FIG. 1 is a front perspective view of a mouthguard illus-  
trating a first embodiment of my new design;

FIG. 2 is a detail view of the embodiment of FIG. 1 within  
line 2 of FIG. 1, showing generally square depression  
features in additional detail;

FIG. 3 is a front view of the embodiment of FIG. 1;

FIG. 4 is a back view of the embodiment of FIG. 1;

FIG. 5 is a left side view of the embodiment of FIG. 1;

FIG. 6 is a right side view of the embodiment of FIG. 1;

FIG. 7 is a top view of the embodiment of FIG. 1;

FIG. 8 is a detail view of the embodiment of FIG. 1 within  
line 8 of FIG. 7, showing the generally square depression  
features in additional detail;

FIG. 9 is a bottom view of the embodiment of FIG. 1;

FIG. 10 is a front perspective view of a mouthguard illus-  
trating a second embodiment of my new design;

FIG. 11 is a detail view of the embodiment of FIG. 10 within  
line 11 of FIG. 10, showing generally hexagonal depression  
features in additional detail;

FIG. 12 is a front view of the embodiment of FIG. 10;

FIG. 13 is a back view of the embodiment of FIG. 10;

FIG. 14 is a left side view of the embodiment of FIG. 10;

FIG. 15 is a right side view of the embodiment of FIG. 10;

FIG. 16 is a top view of the embodiment of FIG. 10;

FIG. 17 is a detail view of the embodiment of FIG. 10 within  
line 17 of FIG. 16, showing the generally hexagonal depres-  
sion features in additional detail;

FIG. 18 is a bottom view of the embodiment of FIG. 10;

(Continued)

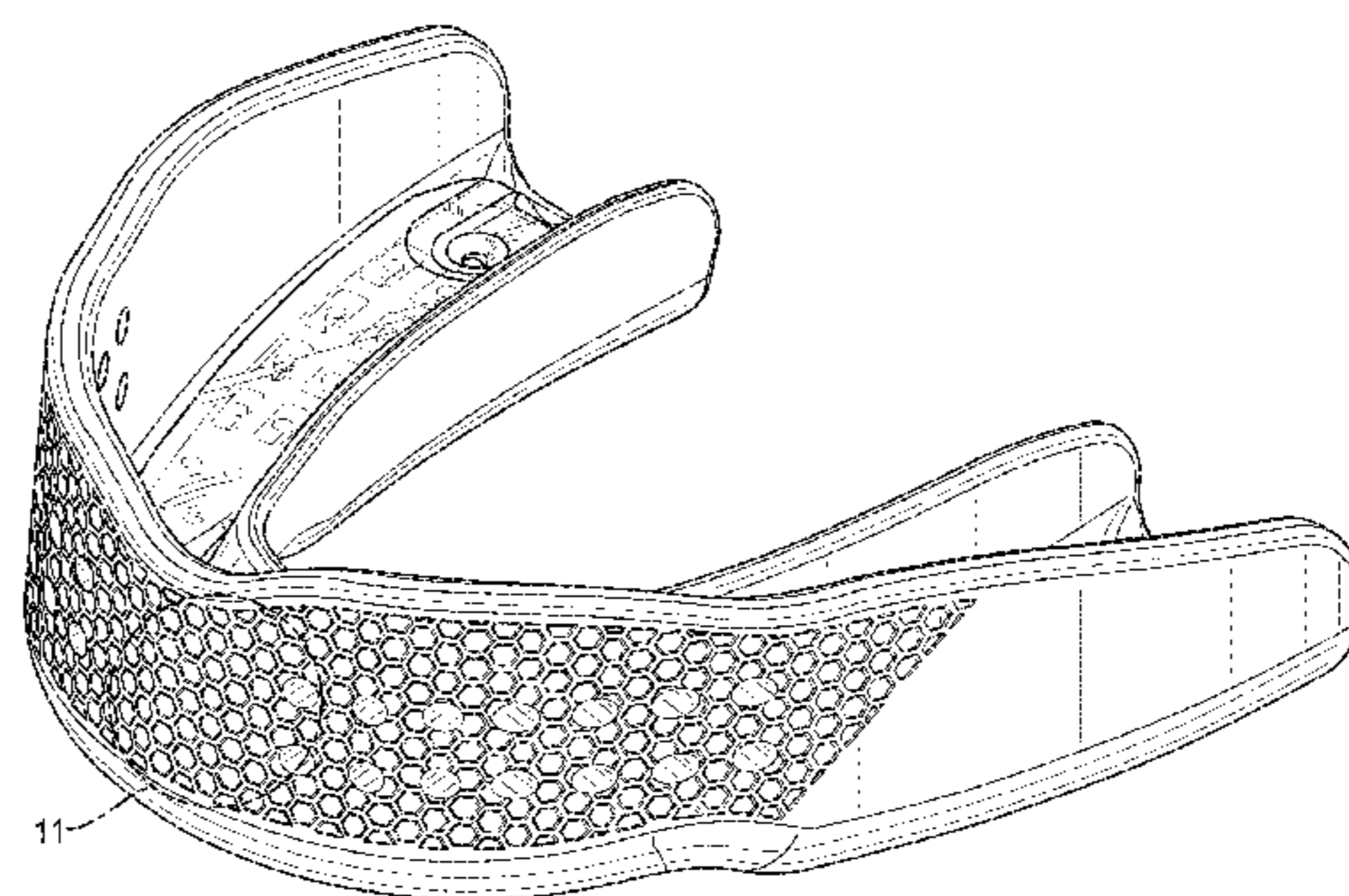
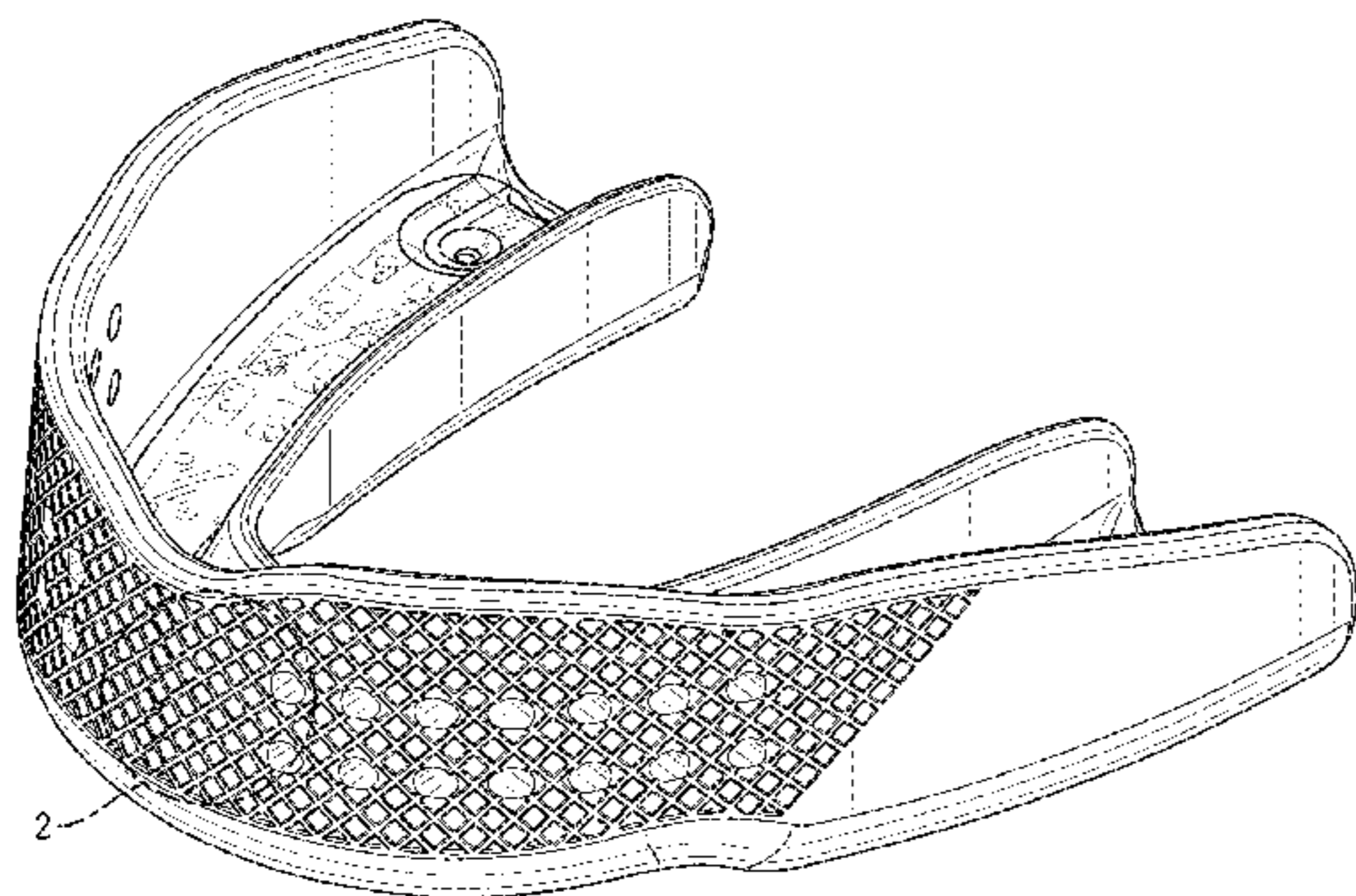

FIG. 19 is a front perspective view of a mouthguard illustrating a third embodiment of my new design;  
 FIG. 20 is a detail view of the embodiment of FIG. 19 within line 20 of FIG. 19, showing generally square depression features in additional detail;  
 FIG. 21 is a front view of the embodiment of FIG. 19;  
 FIG. 22 is a back view of the embodiment of FIG. 19;  
 FIG. 23 is a left side view of the embodiment of FIG. 19;  
 FIG. 24 is a right side view of the embodiment of FIG. 19;  
 FIG. 25 is a top view of the embodiment of FIG. 19;  
 FIG. 26 is a detail view of the embodiment of FIG. 19 within line 26 of FIG. 25, showing the generally square depression features in additional detail;  
 FIG. 27 is a bottom view of the embodiment of FIG. 19;  
 FIG. 28 is a front perspective view of a mouthguard illustrating a fourth embodiment of my new design;  
 FIG. 29 is a detail view of the embodiment of FIG. 28 within line 29 of FIG. 28, showing generally circular depression features in additional detail;  
 FIG. 30 is a front view of the embodiment of FIG. 28;  
 FIG. 31 is a back view of the embodiment of FIG. 28;  
 FIG. 32 is a left side view of the embodiment of FIG. 28;  
 FIG. 33 is a right side view of the embodiment of FIG. 28;  
 FIG. 34 is a top view of the embodiment of FIG. 28;  
 FIG. 35 is a detail view of the embodiment of FIG. 28 within line 35 of FIG. 34, showing the generally circular depression features in additional detail; and,  
 FIG. 36 is a bottom view of the embodiment of FIG. 28.  
 The dot-dash broken lines in the drawings indicate portions of the claimed design that are illustrated in enlargements, and the dot-dash broken lines form no part of the claimed design.

**1 Claim, 36 Drawing Sheets**

(58) **Field of Classification Search**

CPC ..... A61C 19/063; A61C 5/90; A61C 7/08;  
 A61C 7/10; A61C 13/08; A61C 13/081;  
 A61C 13/083; A61C 13/087; A61C  
 19/066; A61C 5/14; A61F 5/566; A61F  
 5/58; A63B 2071/088; A63B 2071/086

See application file for complete search history.

(56) **References Cited**

U.S. PATENT DOCUMENTS

D693,966	S	*	11/2013	Hanson	.....	D29/108
D830,001	S	*	10/2018	Turkbas	.....	D29/108
D830,002	S	*	10/2018	Turkbas	.....	D29/108
D830,640	S	*	10/2018	Supple	.....	D29/108
D834,258	S	*	11/2018	Turkbas	.....	D29/108
2004/0146837	A1	*	7/2004	Andersen	.....	A61C 5/00 433/215
2012/0090625	A1	*	4/2012	Evans	.....	A63B 71/085 128/861
2013/0068237	A1	*	3/2013	Herman	.....	A61C 5/90 128/862
2013/0291874	A1	*	11/2013	Engel	.....	A61C 19/063 128/861
2014/0093836	A1	*	4/2014	Wolpo	.....	A61C 17/3481 433/32
2016/0001160	A1	*	1/2016	Engel	.....	A63B 71/085 128/861
2017/0172717	A1	*	6/2017	Deng	.....	A61C 19/066
2018/0014912	A1	*	1/2018	Radmand	.....	A61C 5/007

\* cited by examiner

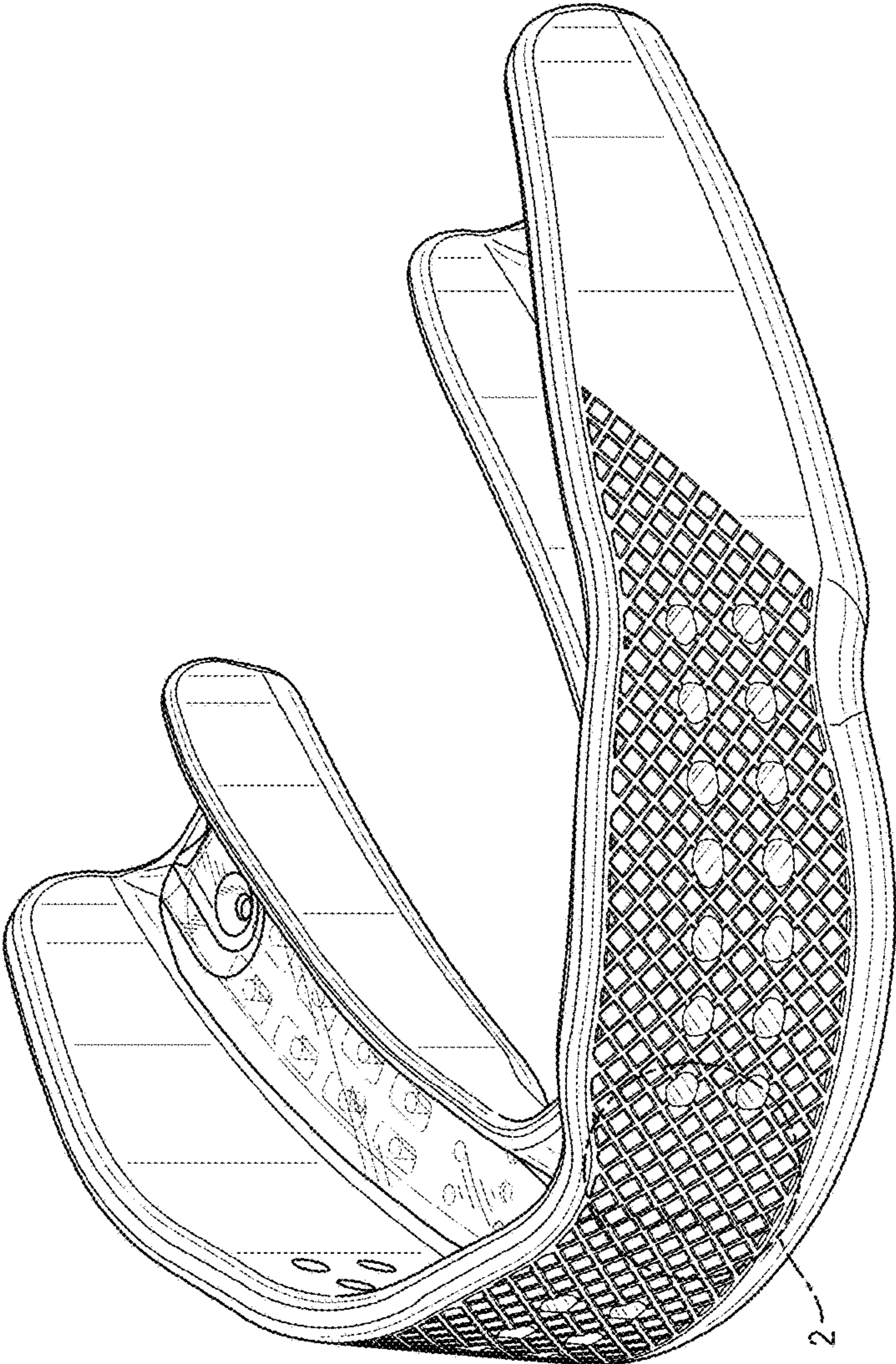

FIG. 1

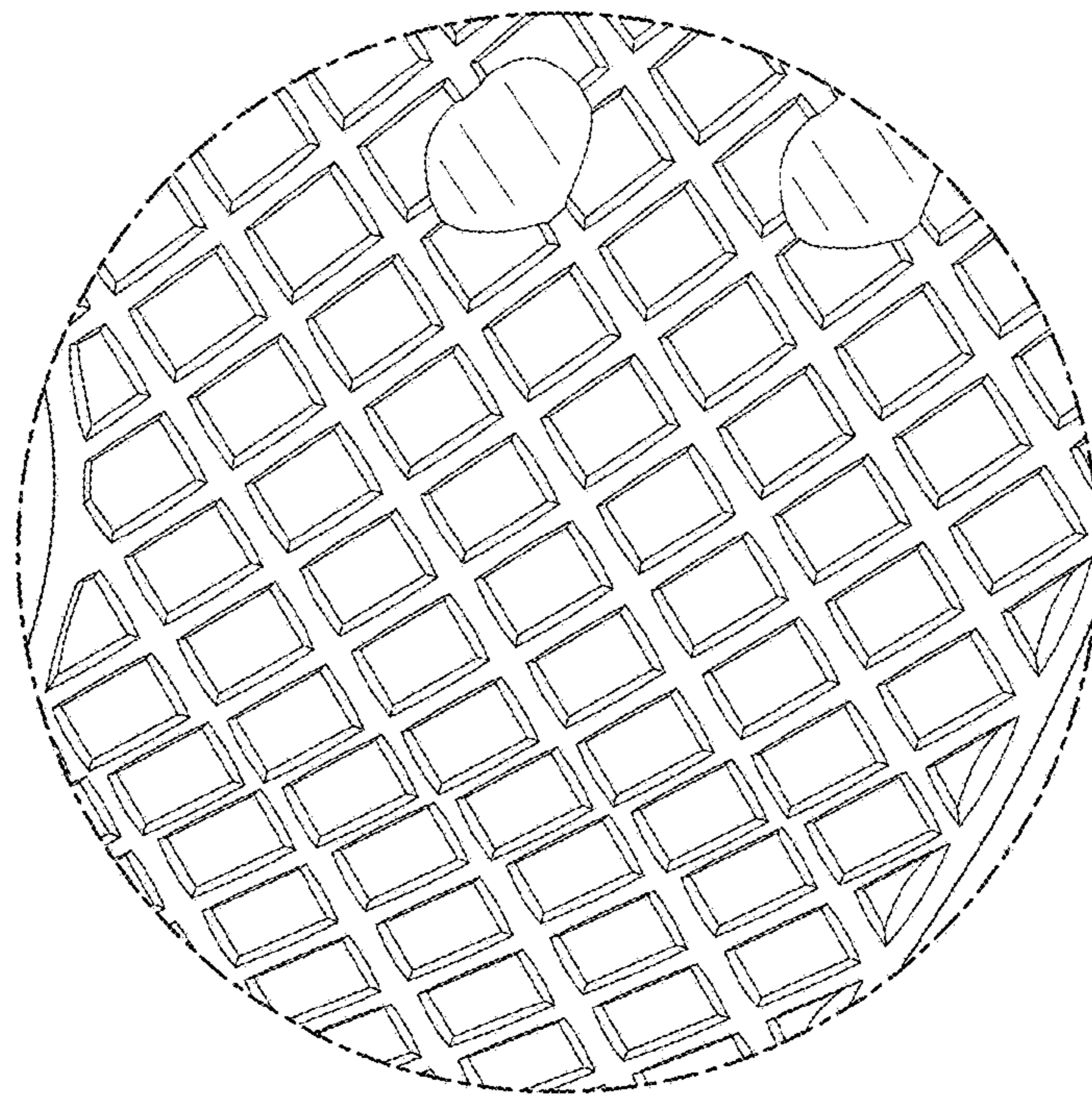

FIG. 2

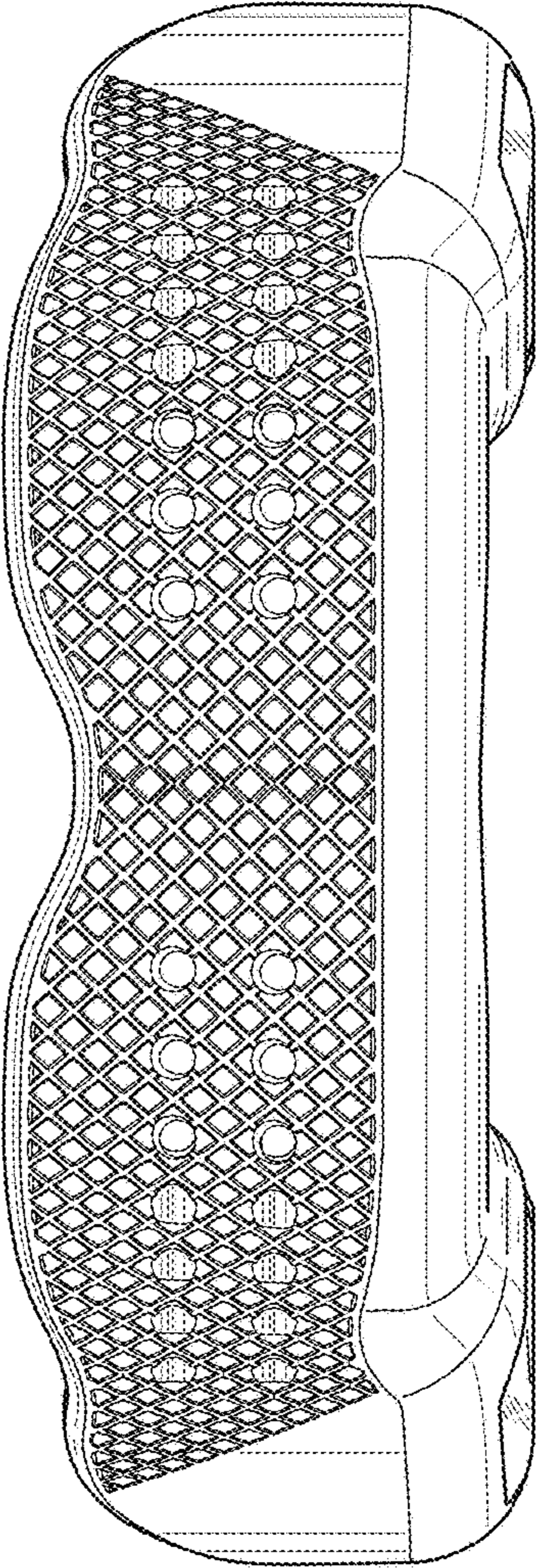

FIG. 3

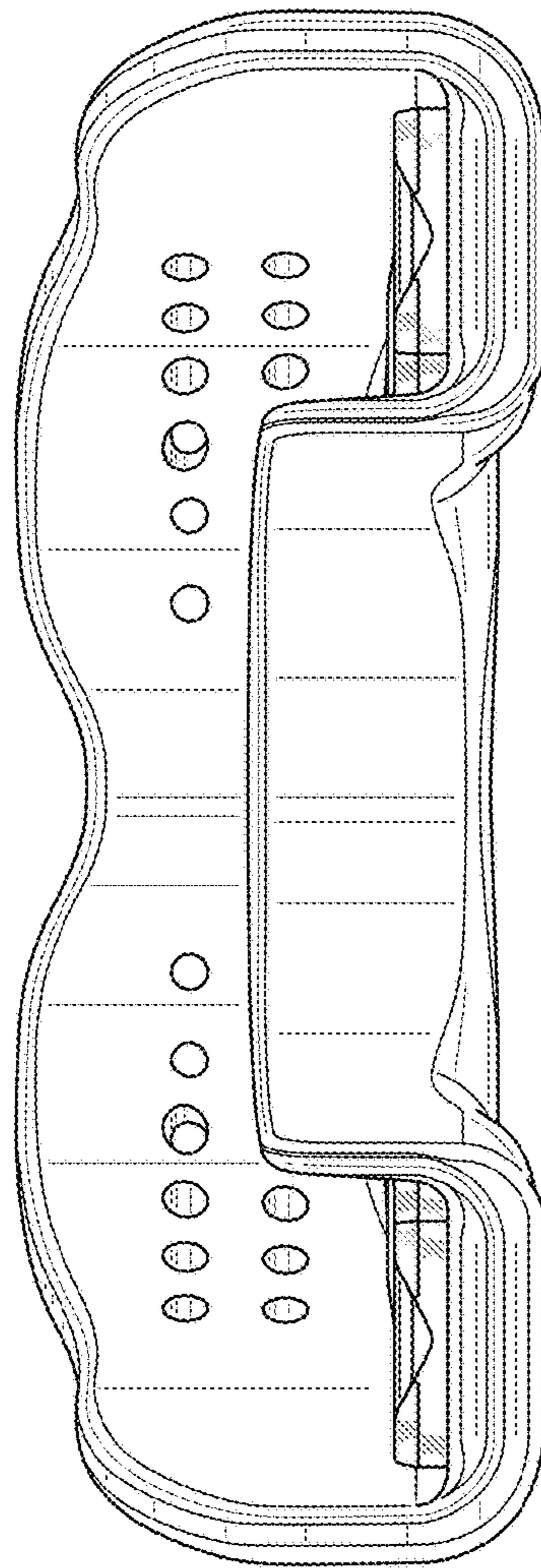

FIG. 4

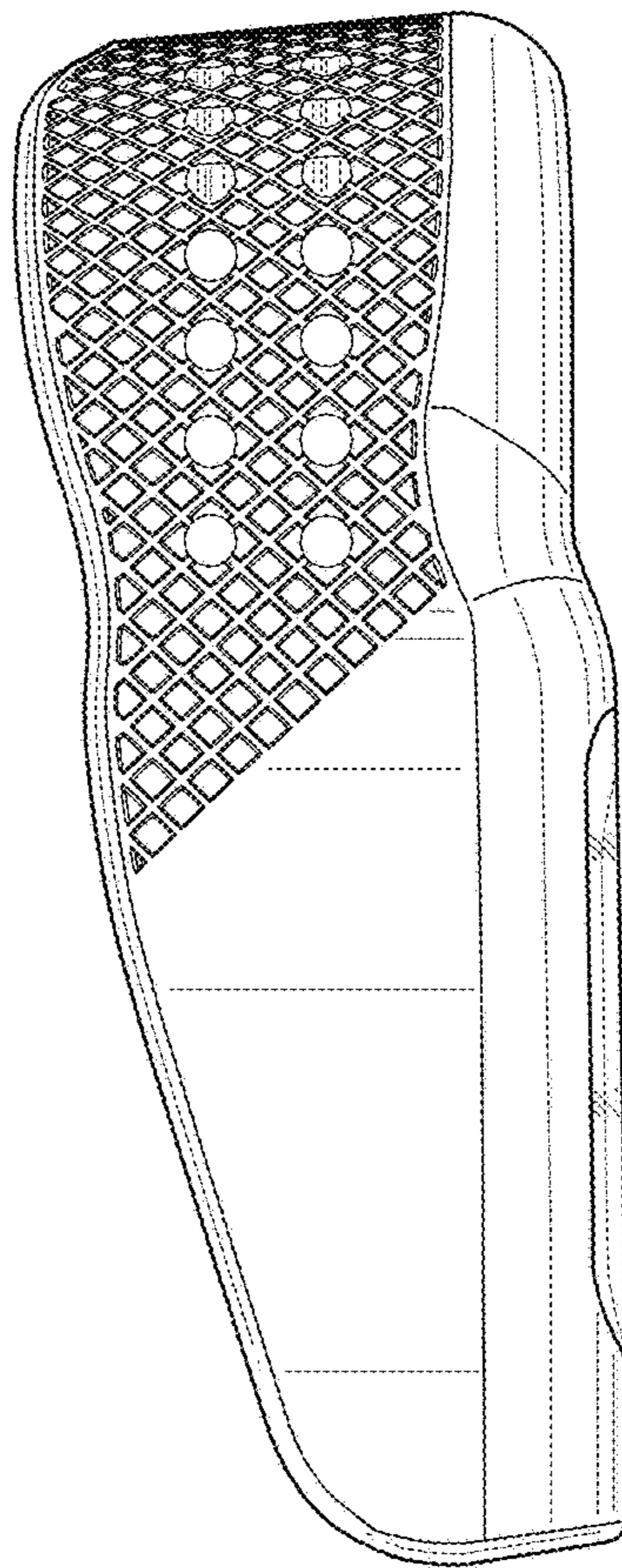

FIG. 5

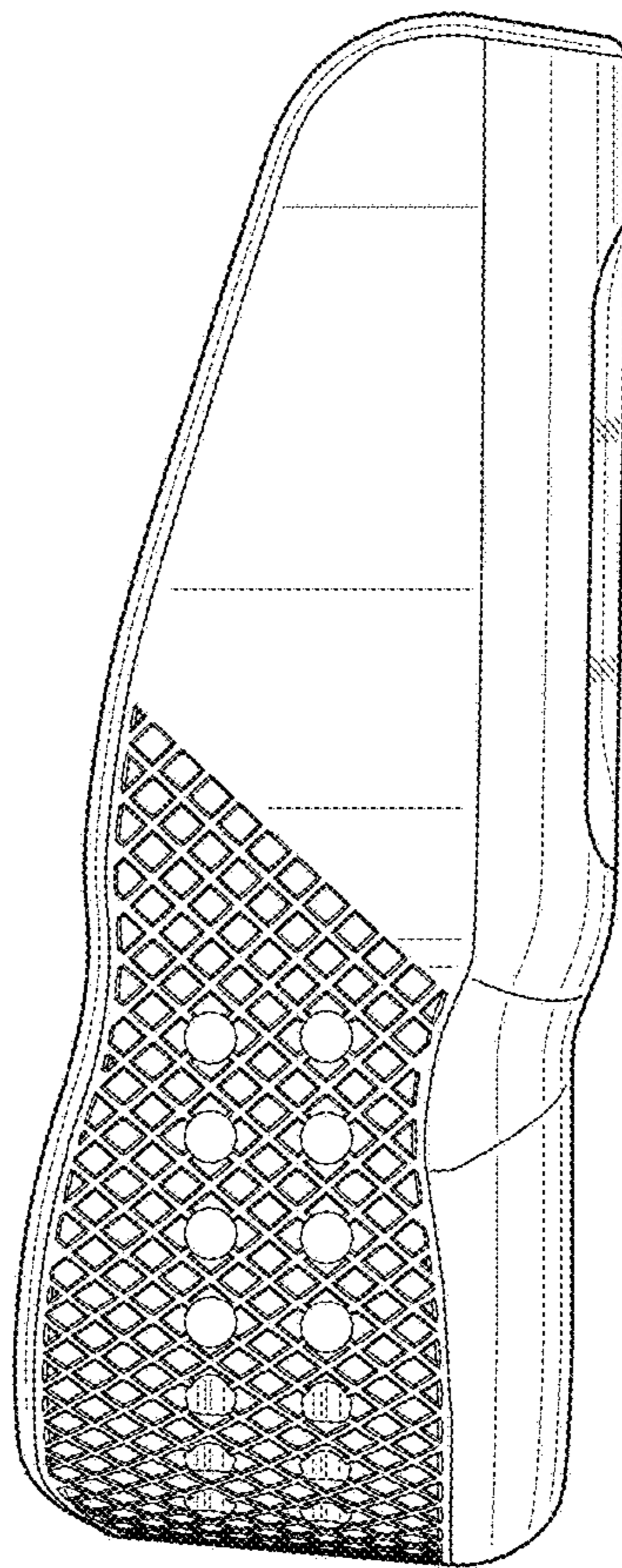
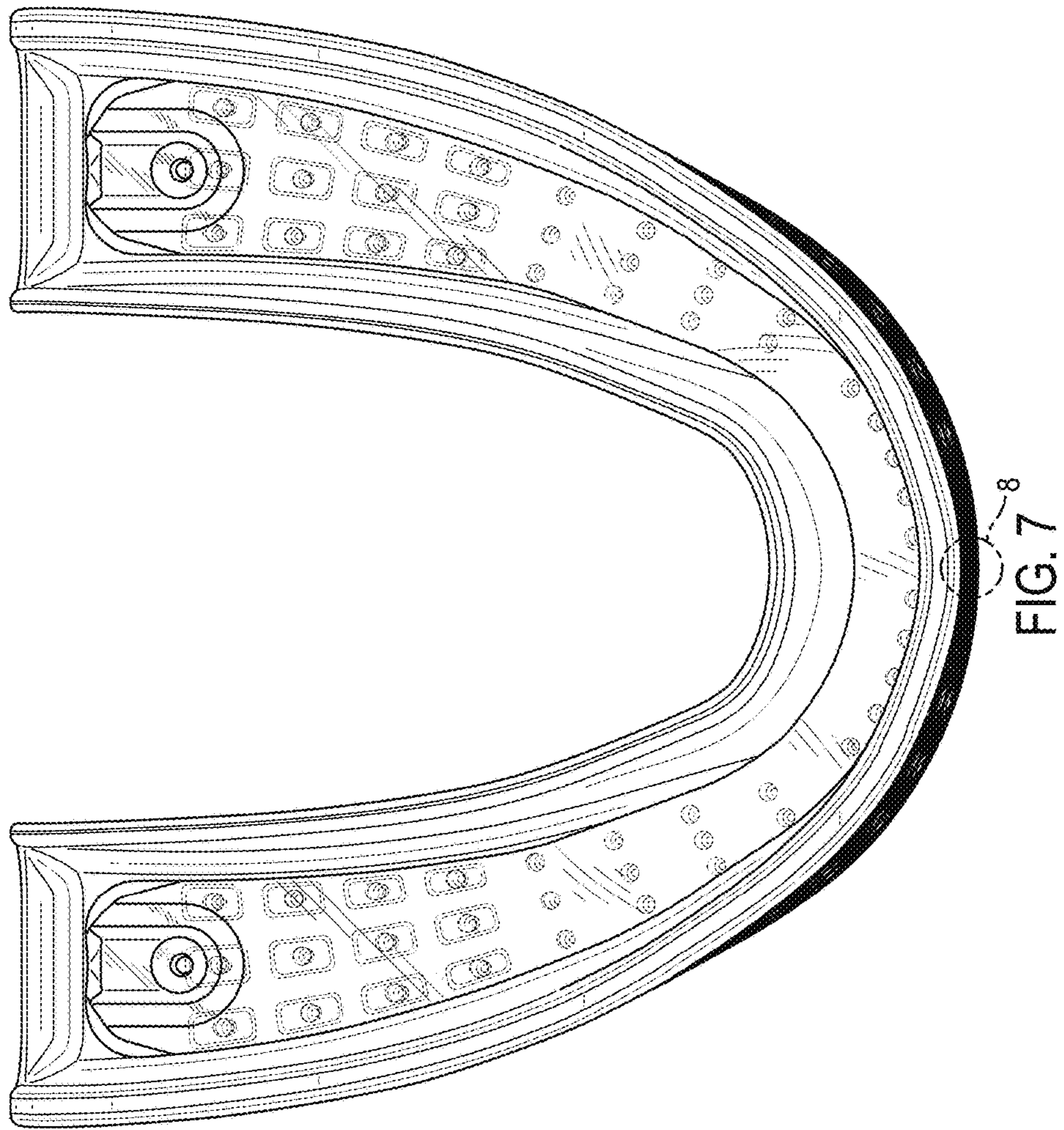

FIG. 6





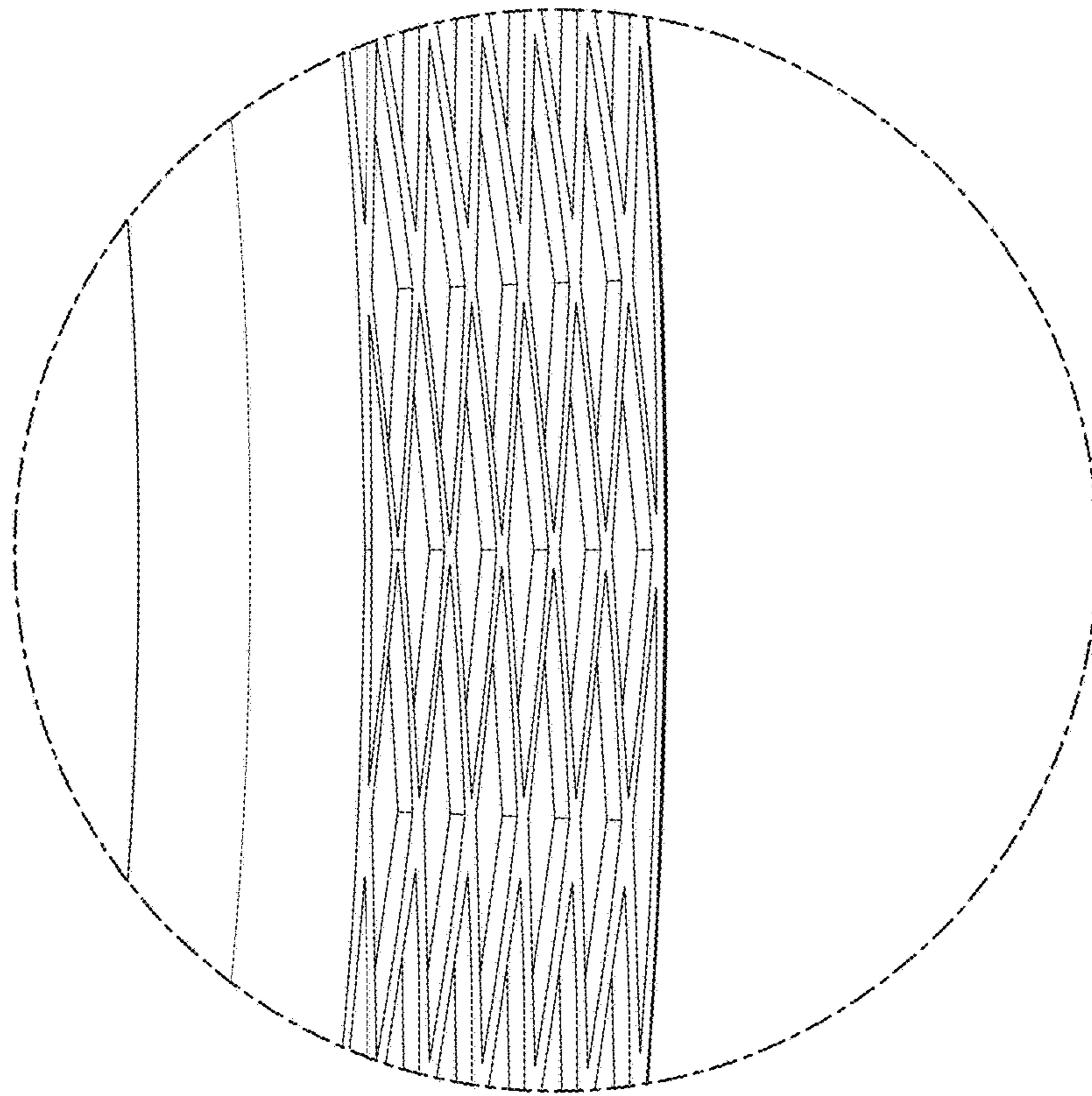

FIG. 8

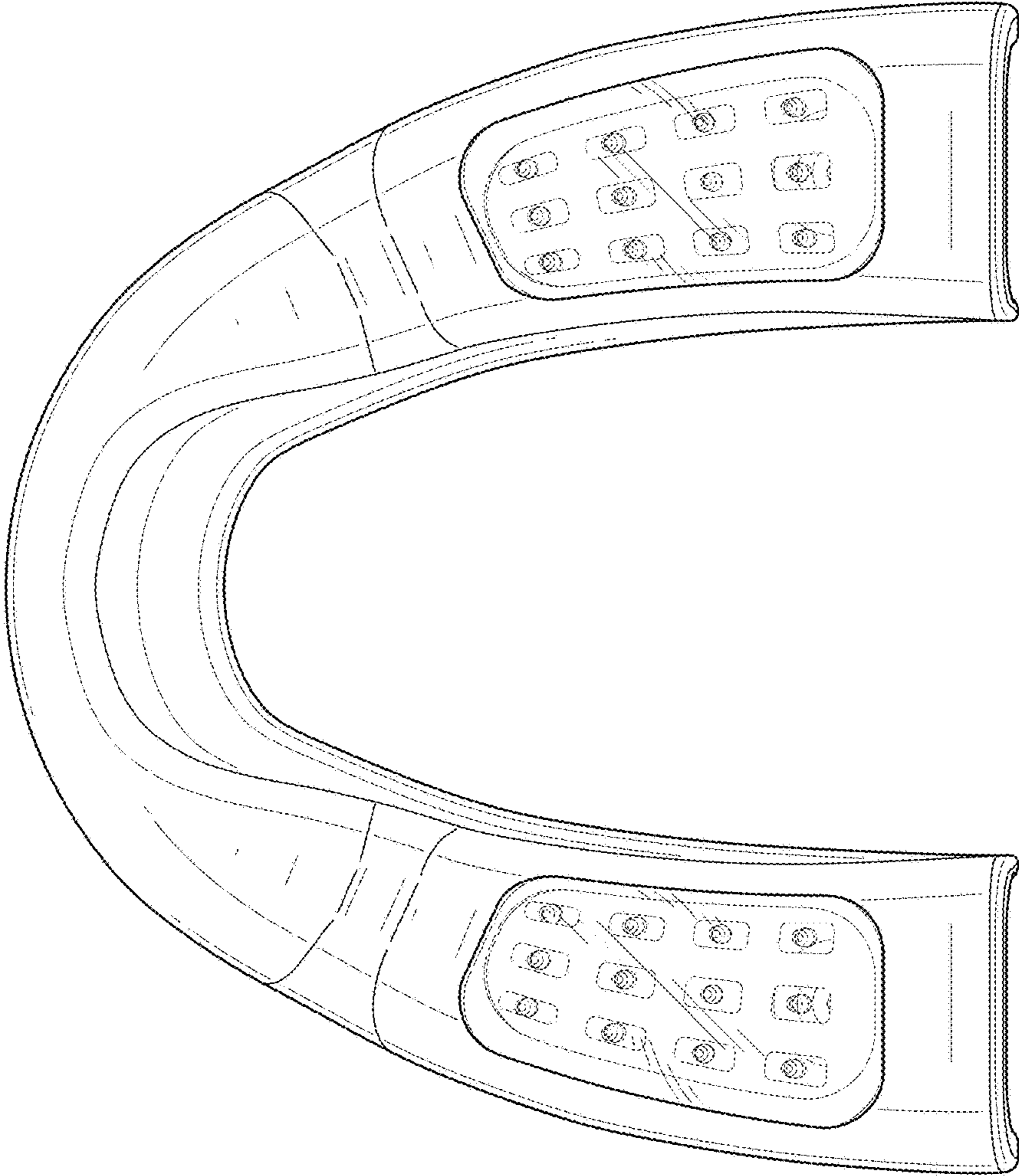

FIG. 9

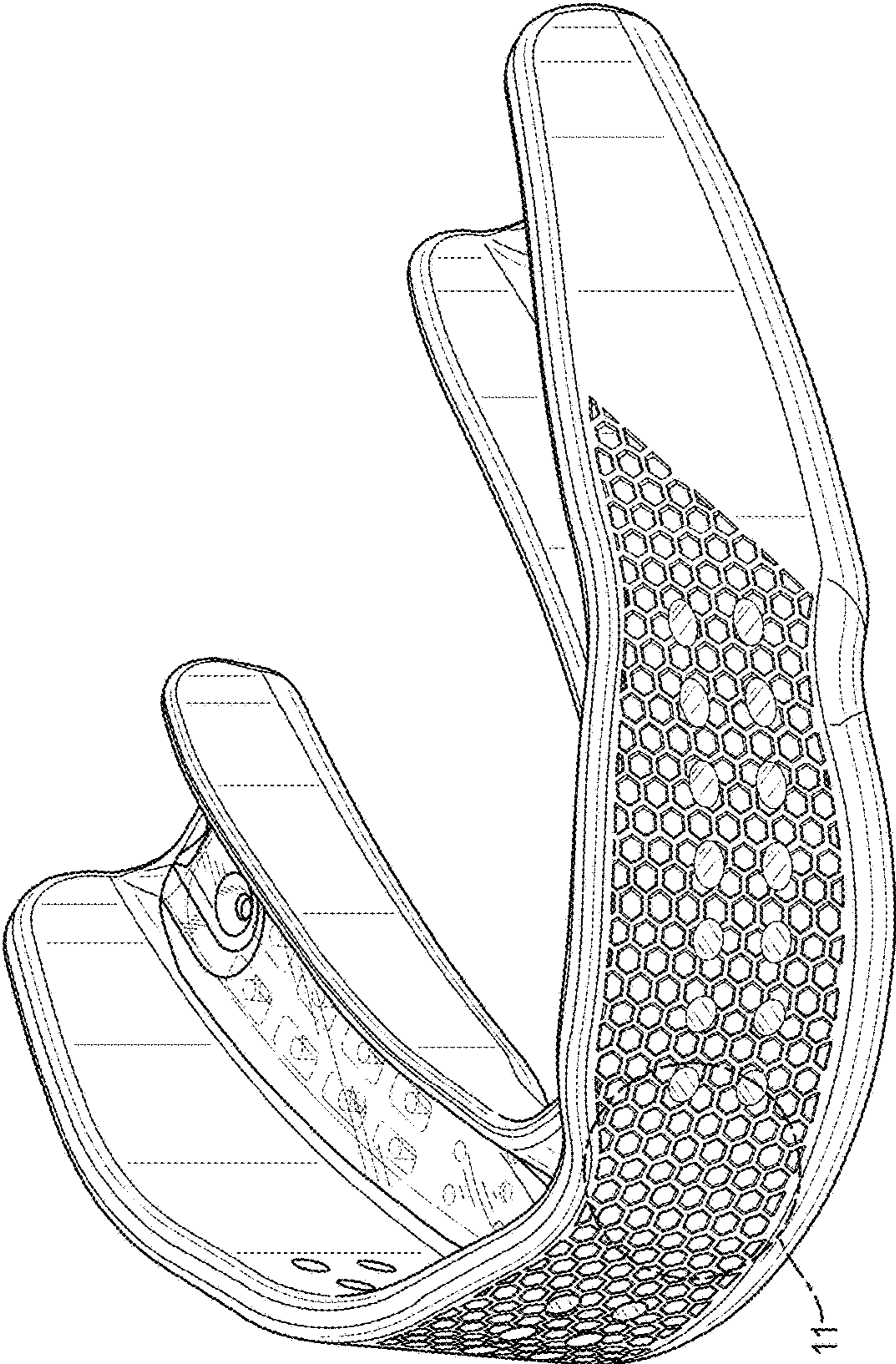

FIG. 10

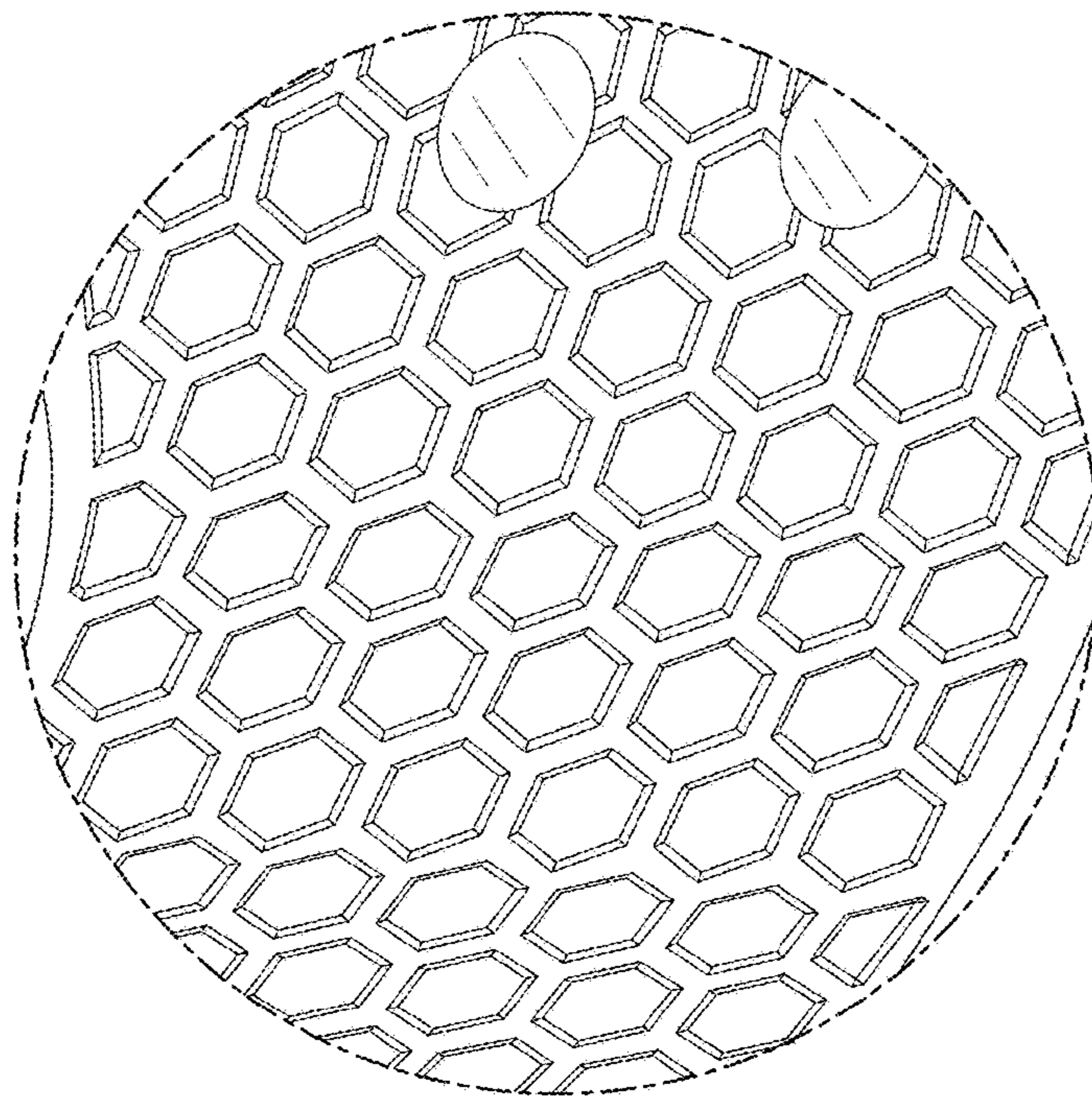

FIG. 11

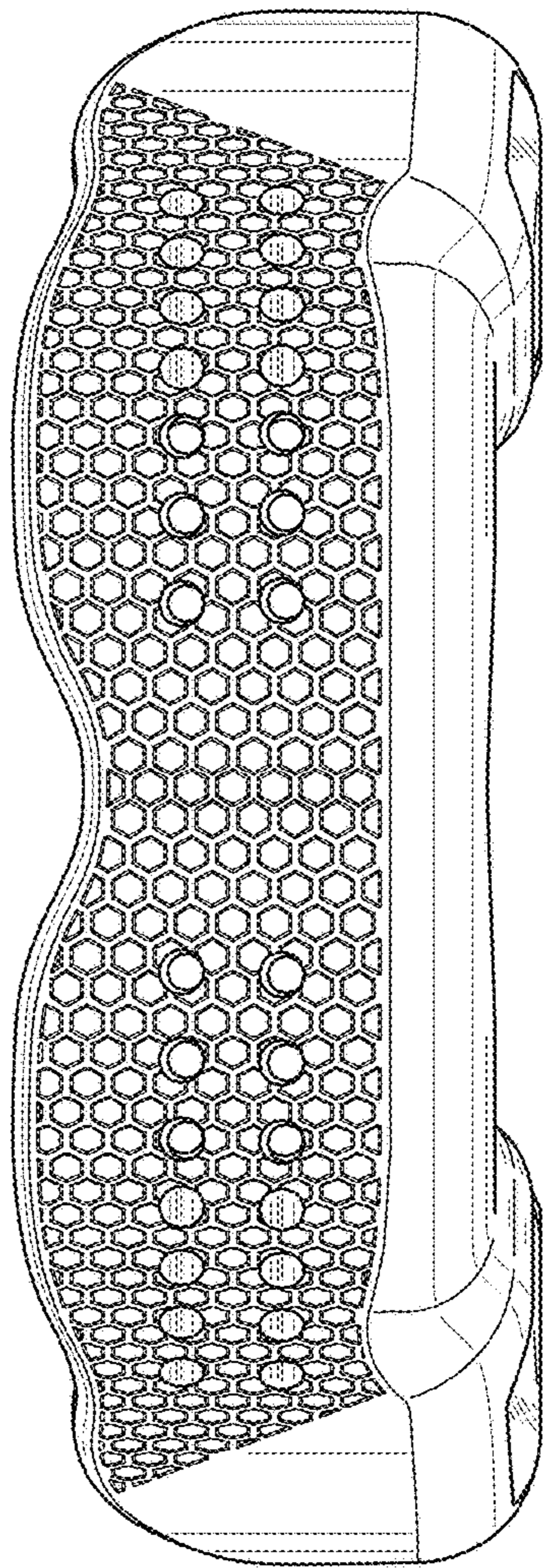

FIG. 12

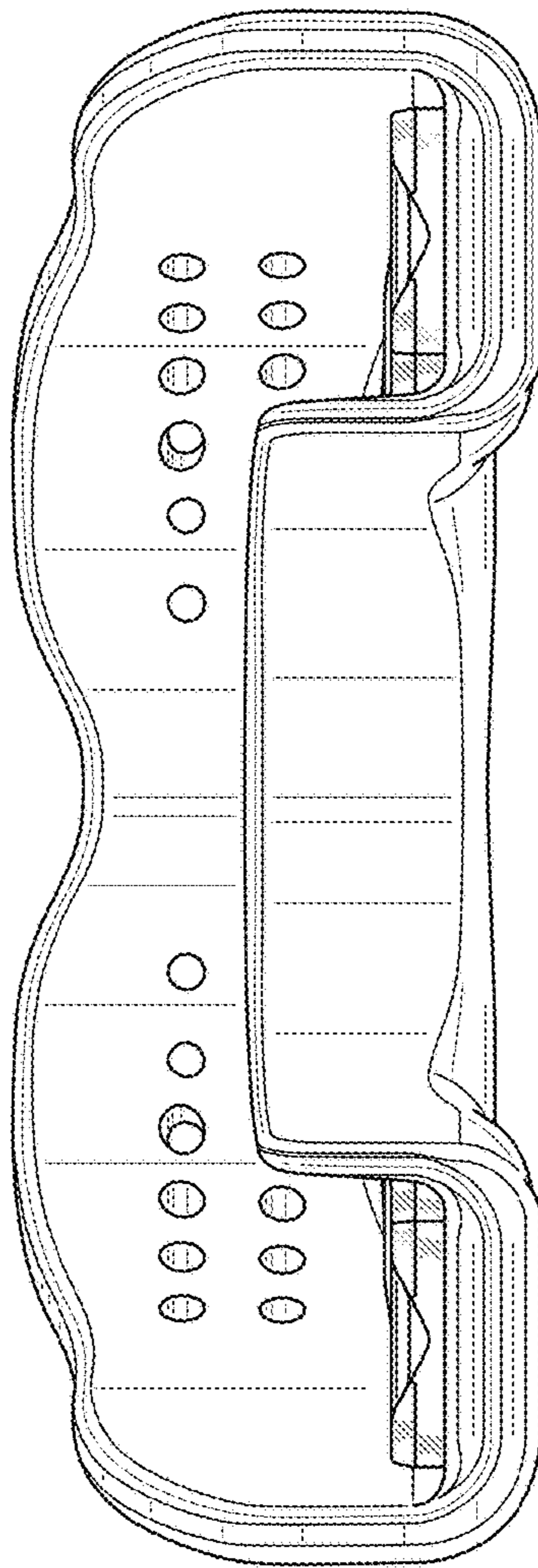

FIG. 13

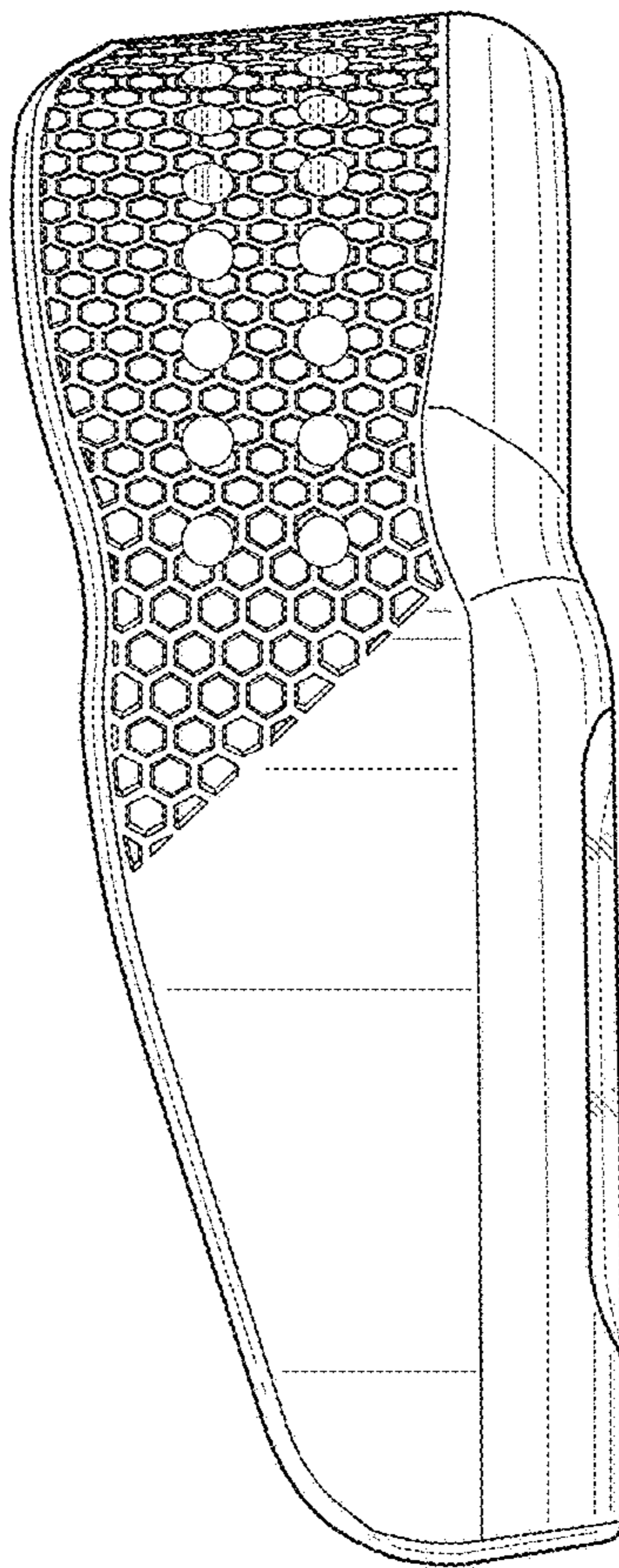

FIG. 14



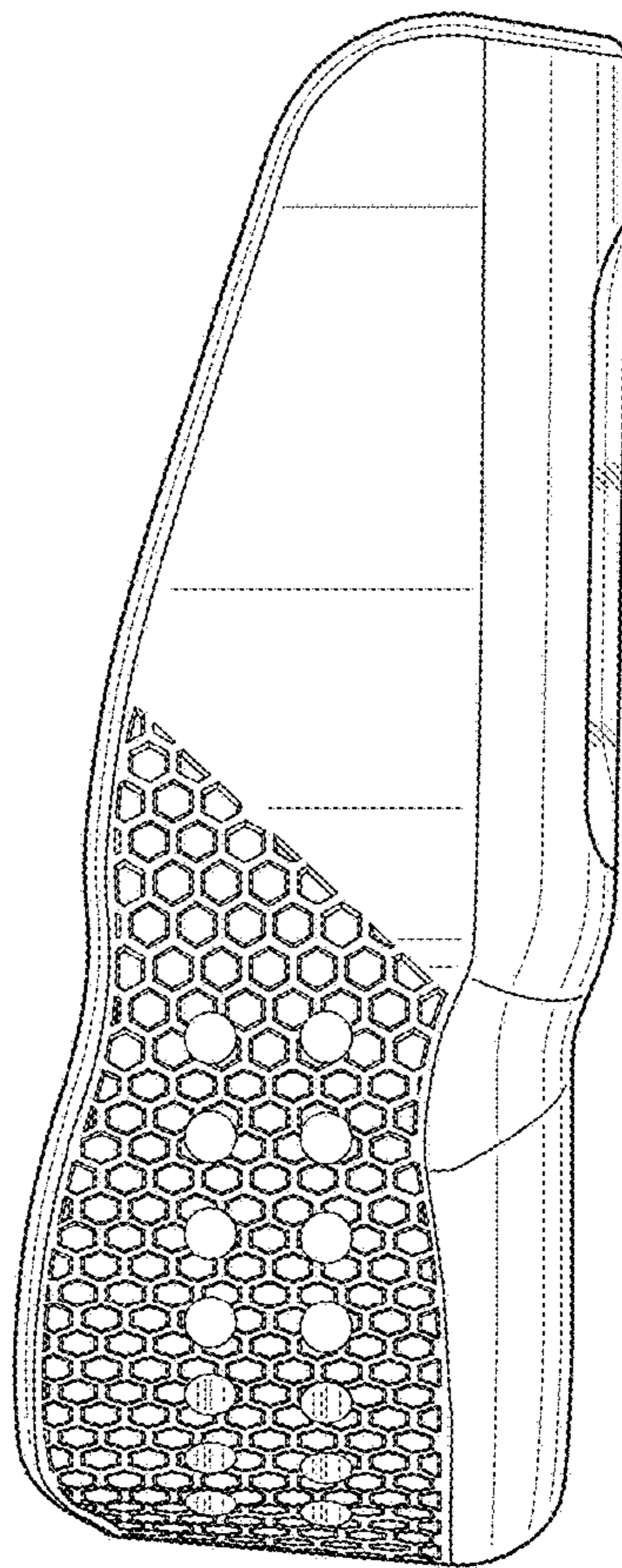

FIG. 15

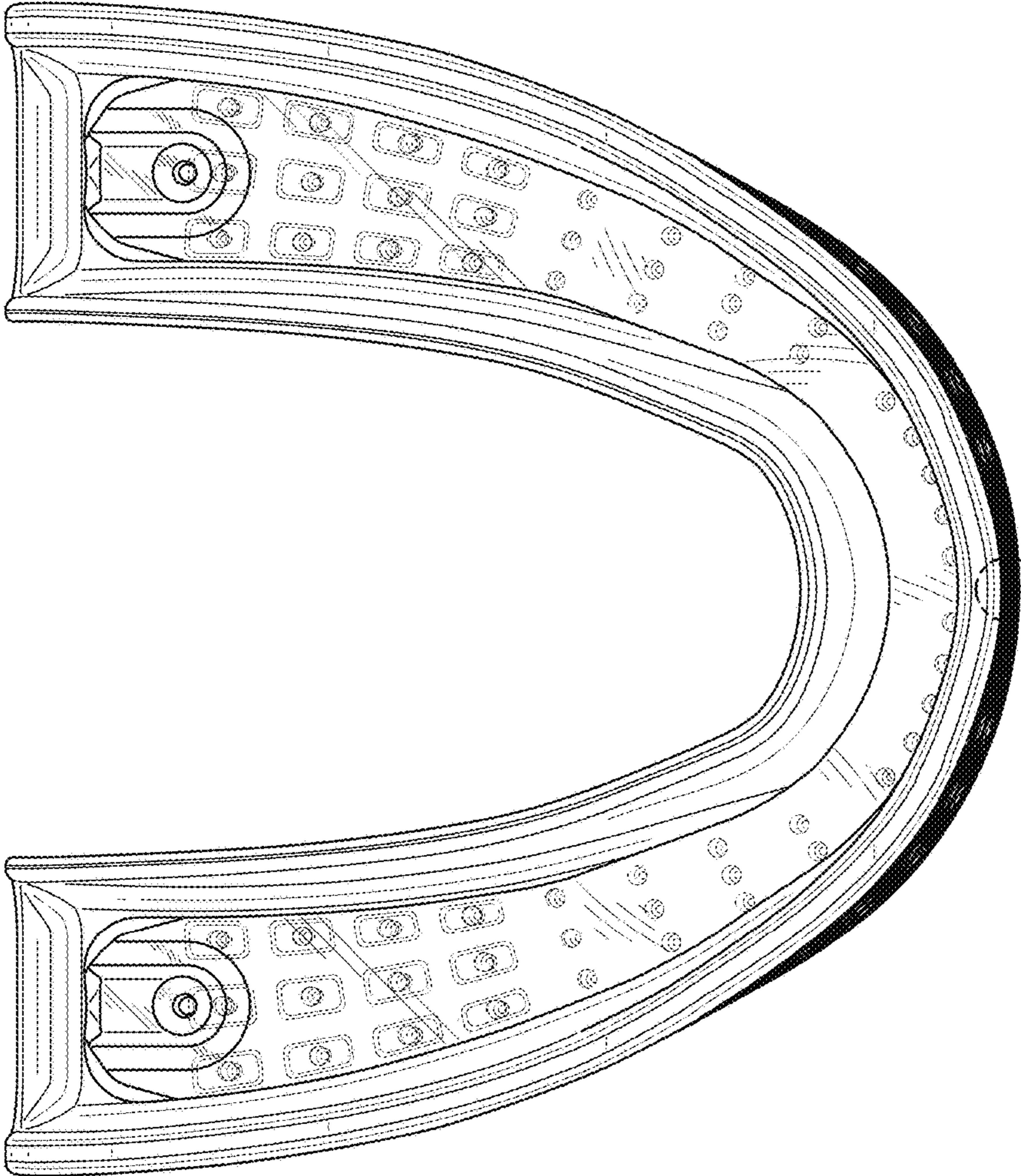

FIG. 16

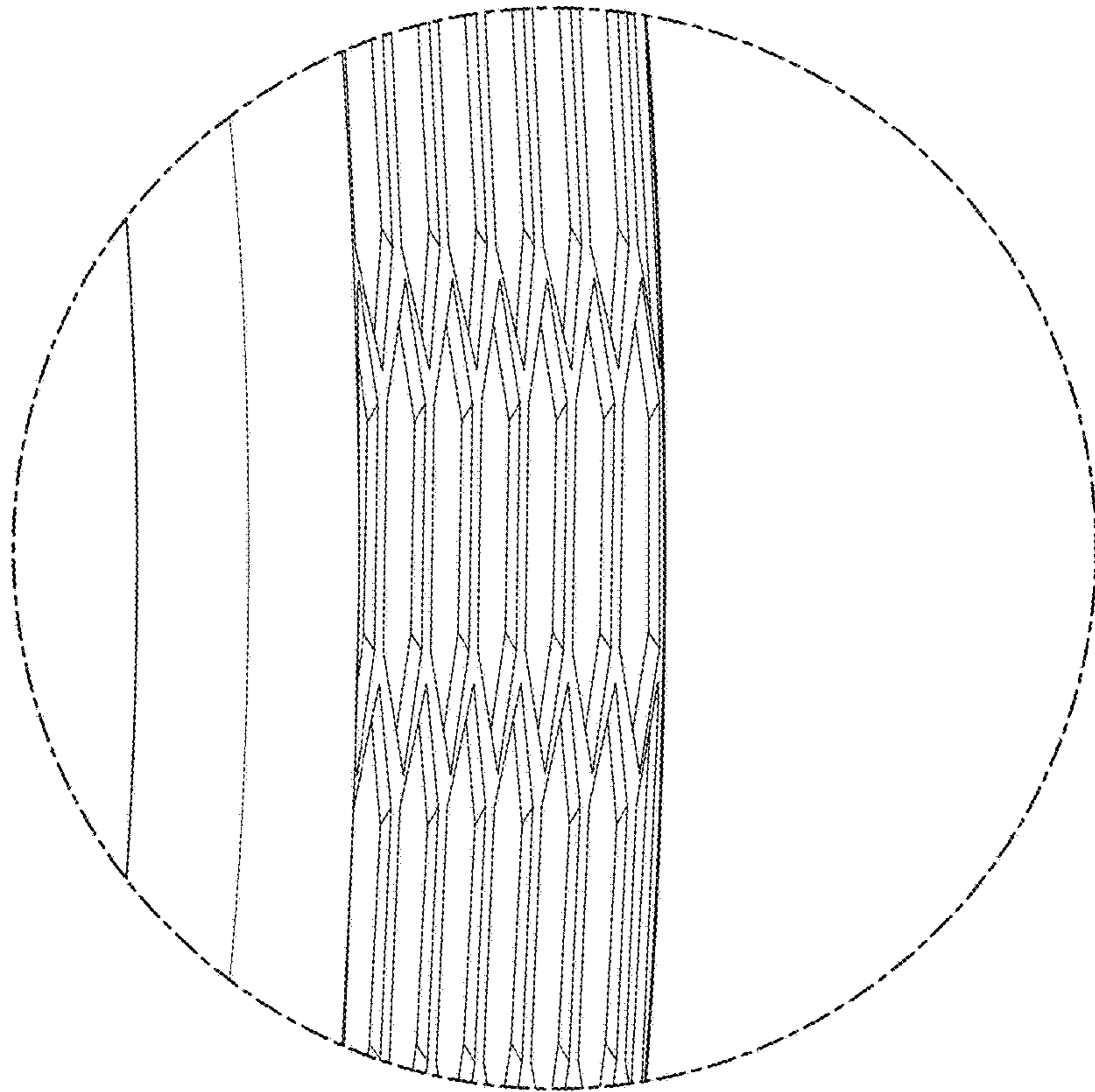

FIG. 17

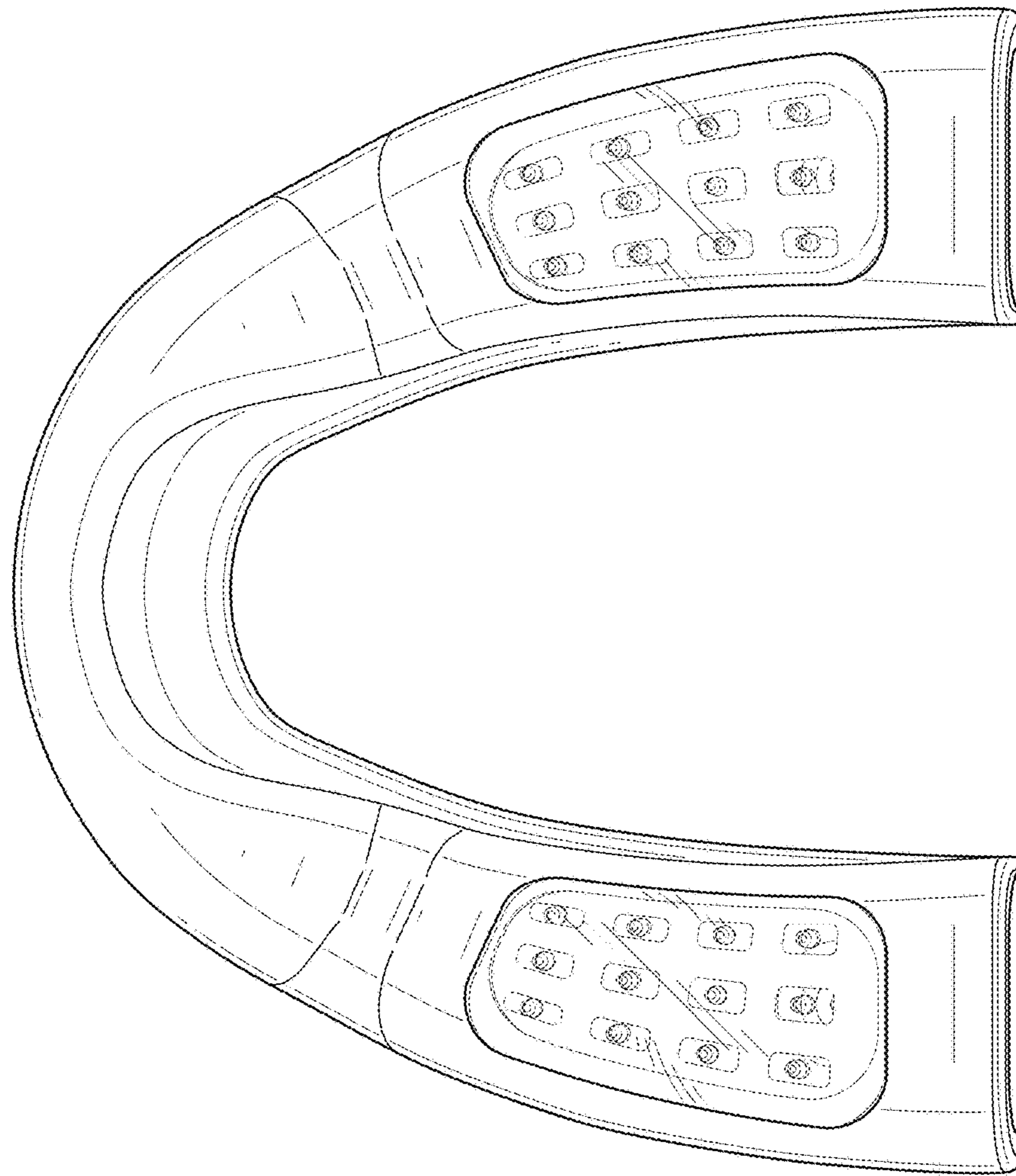

FIG. 18

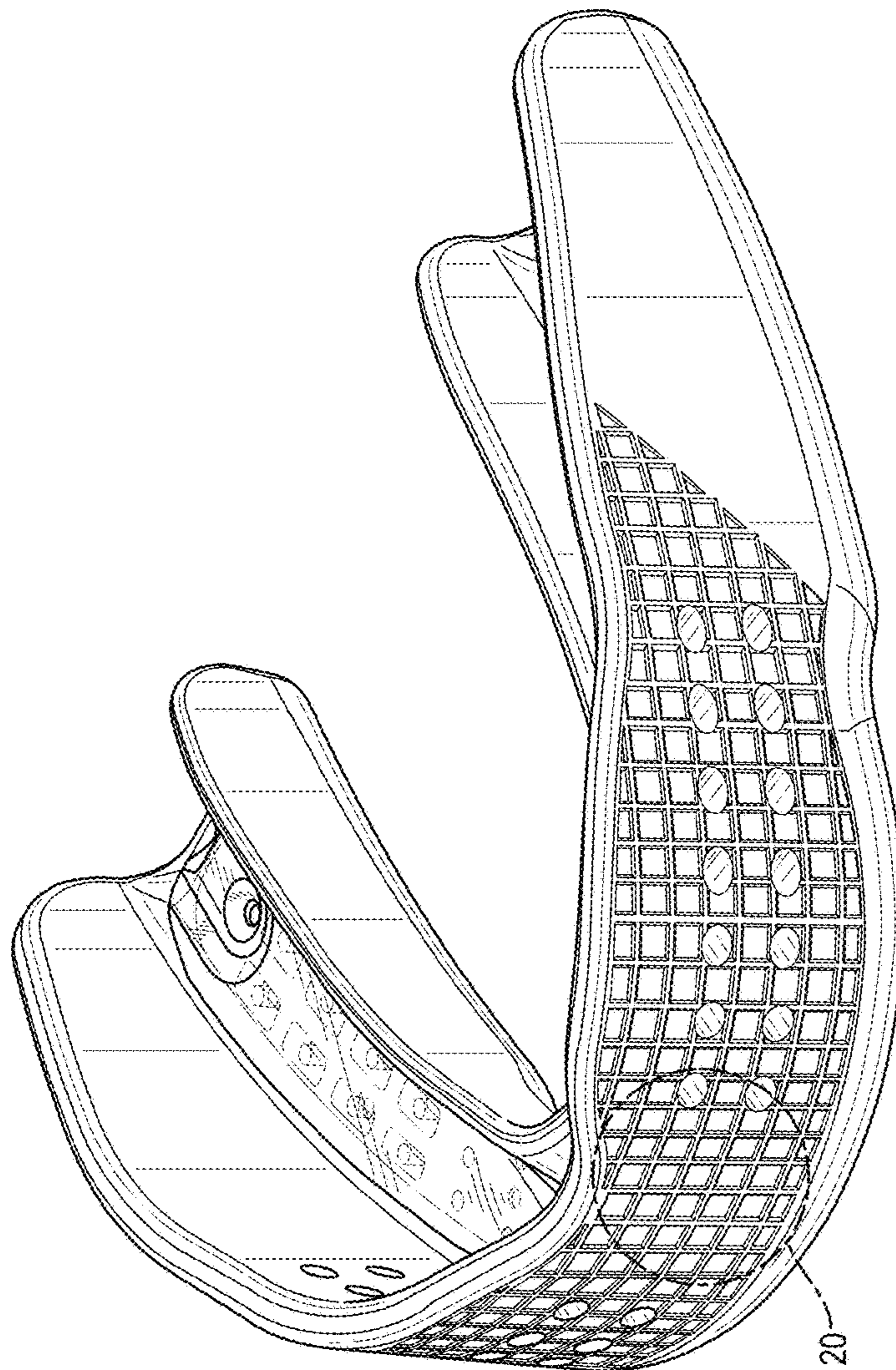

FIG. 19

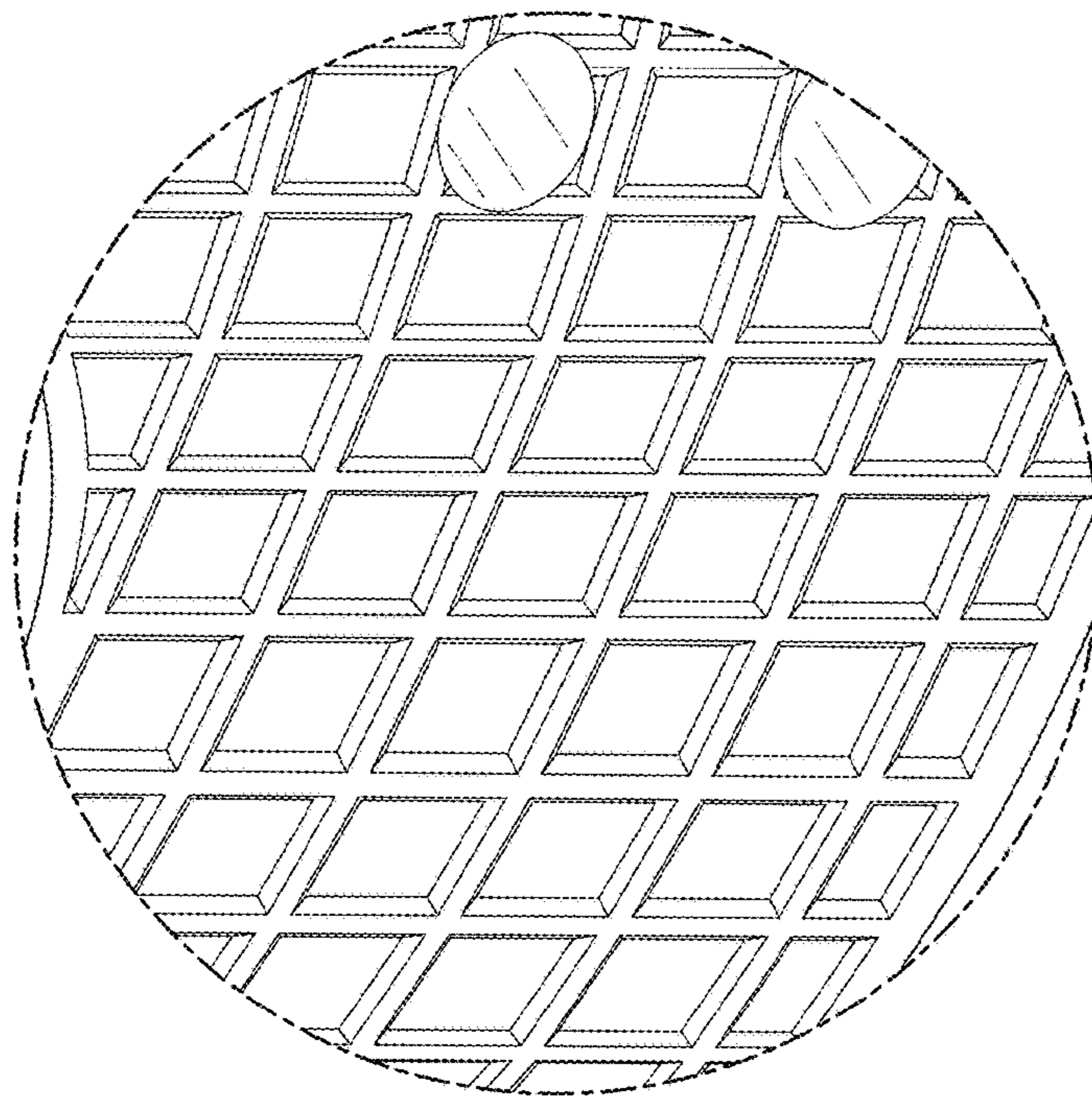

FIG. 20

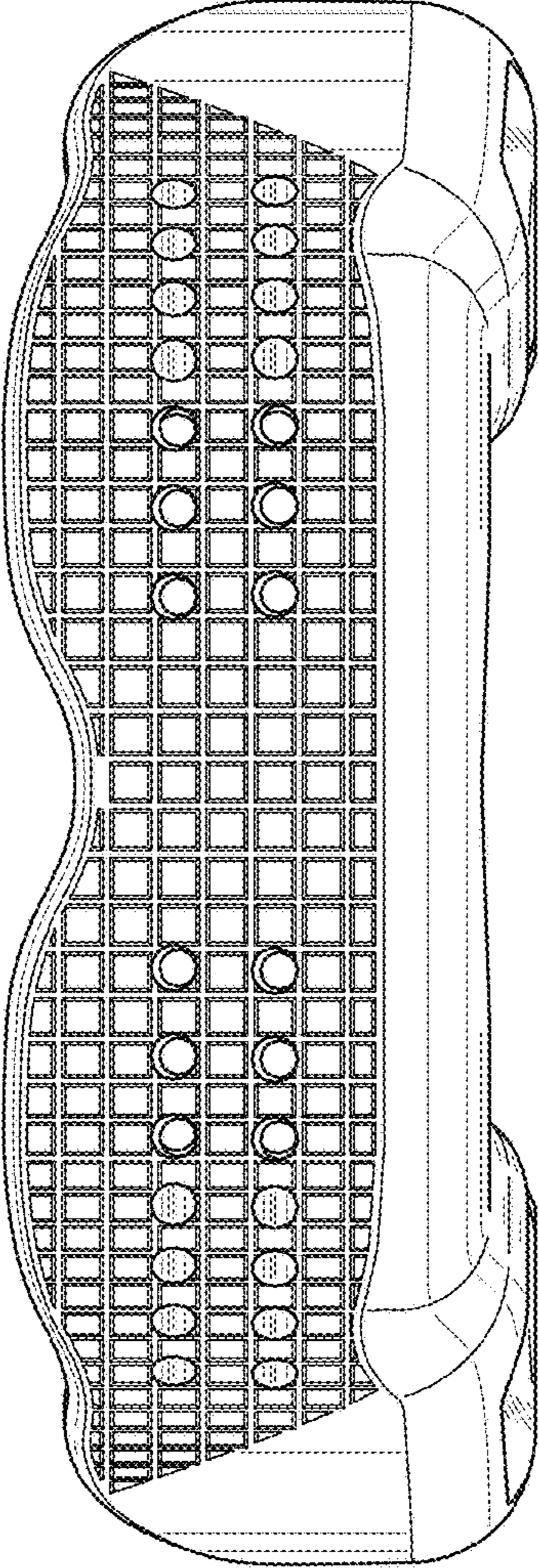

FIG. 21

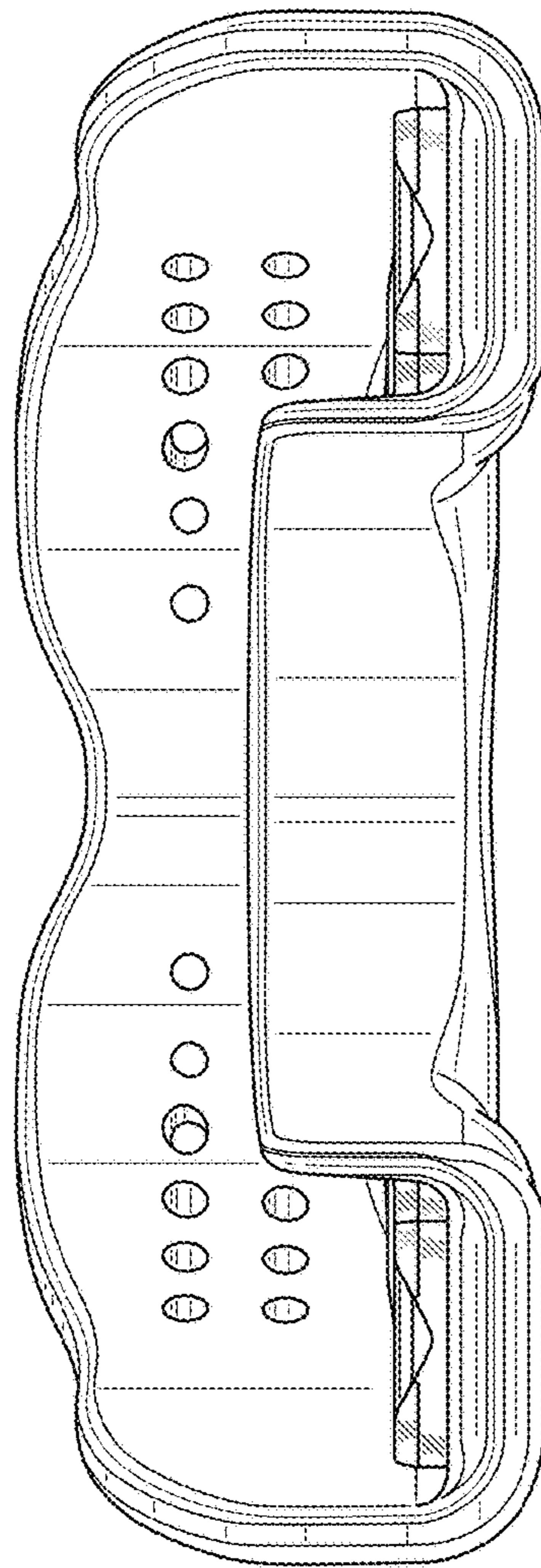

FIG. 22



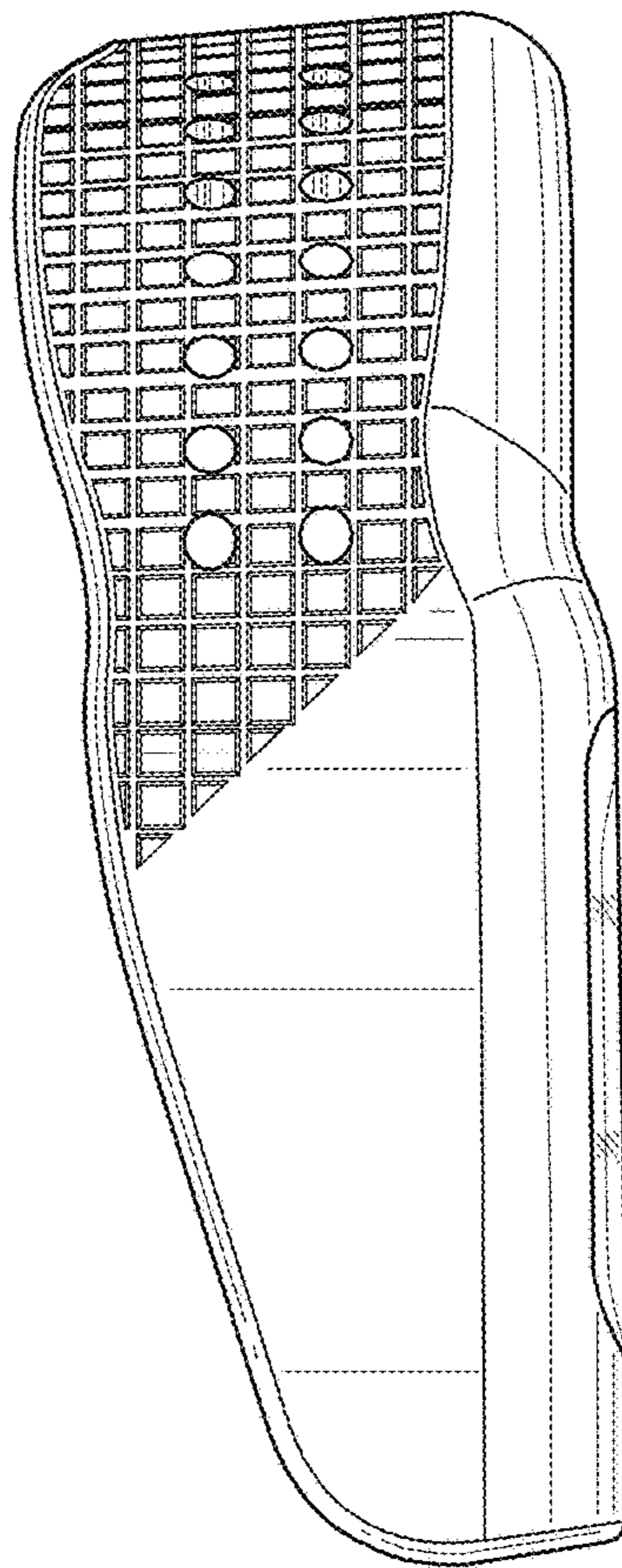

FIG. 23

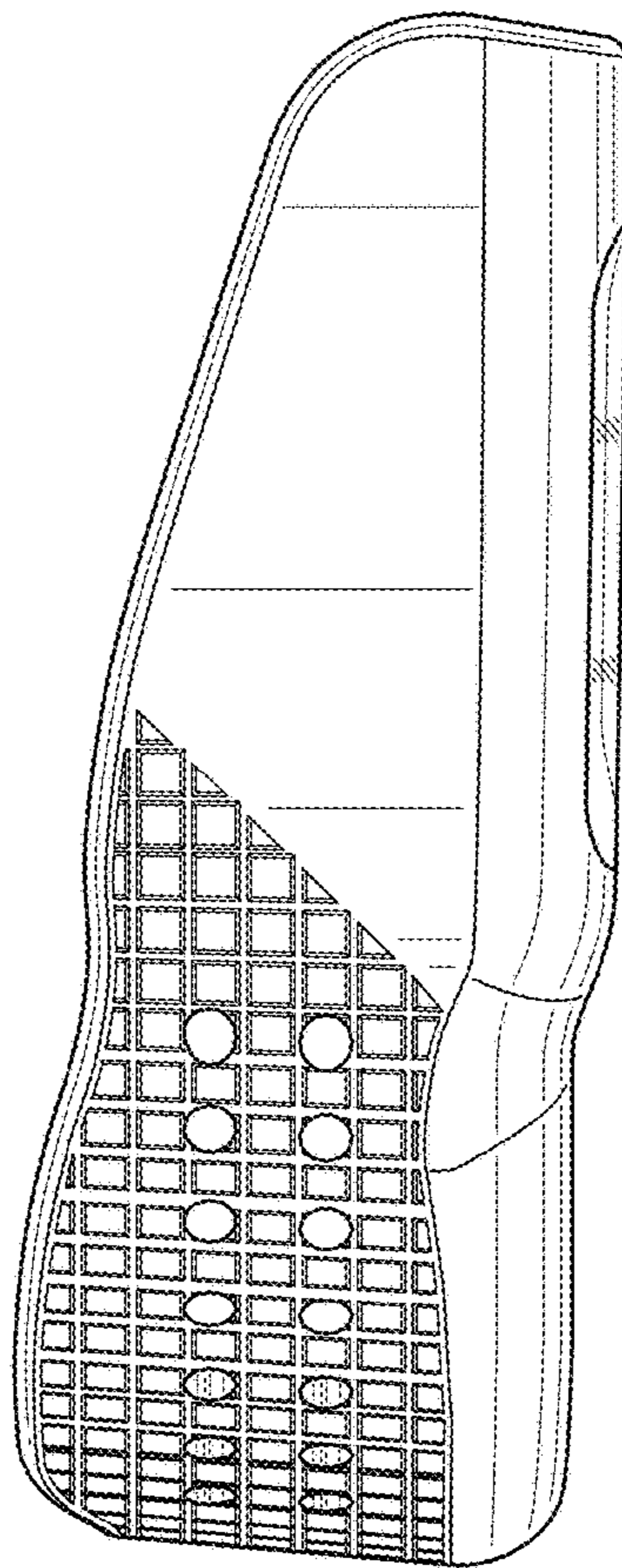

FIG. 24

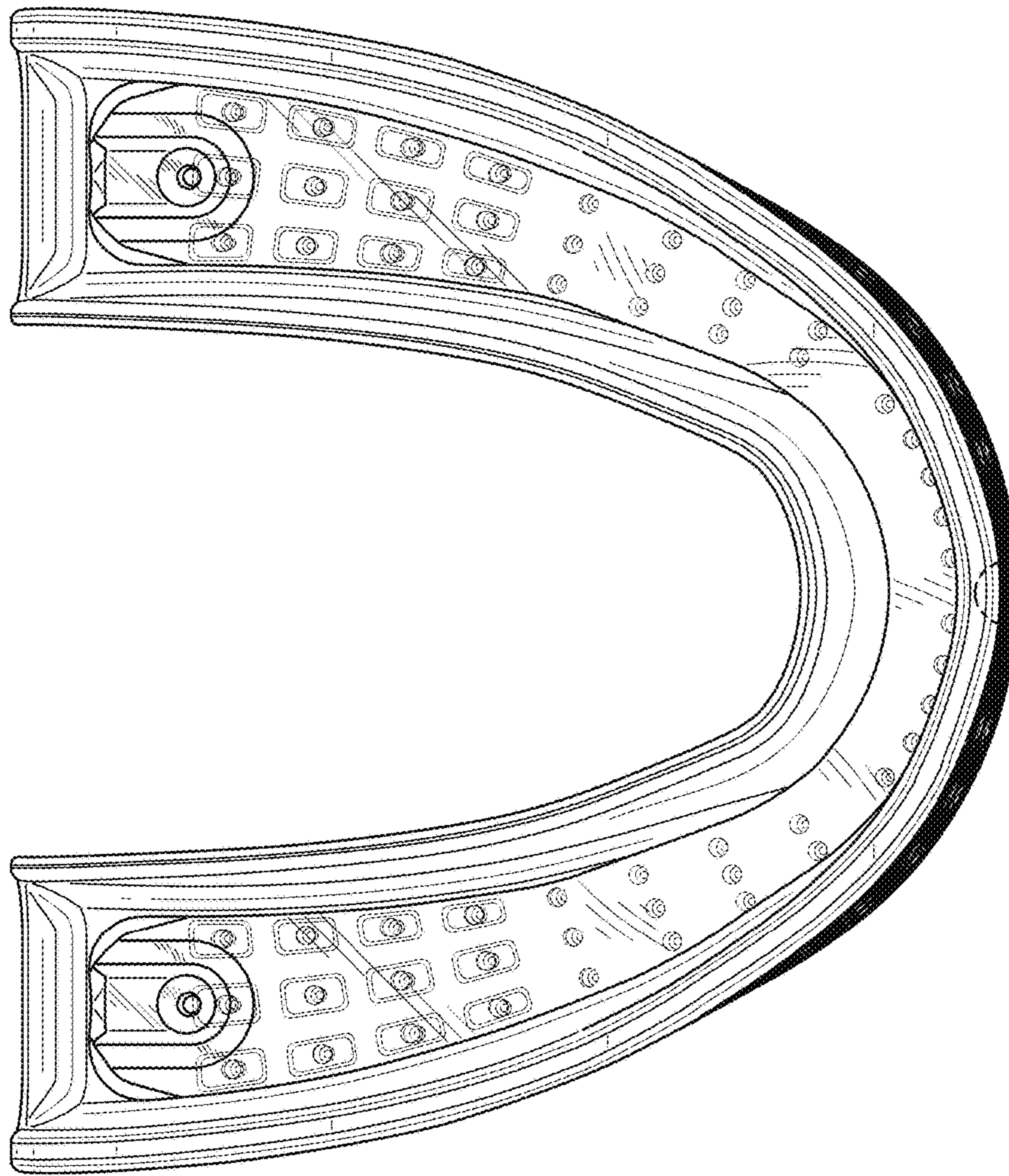

FIG. 25<sup>26</sup>

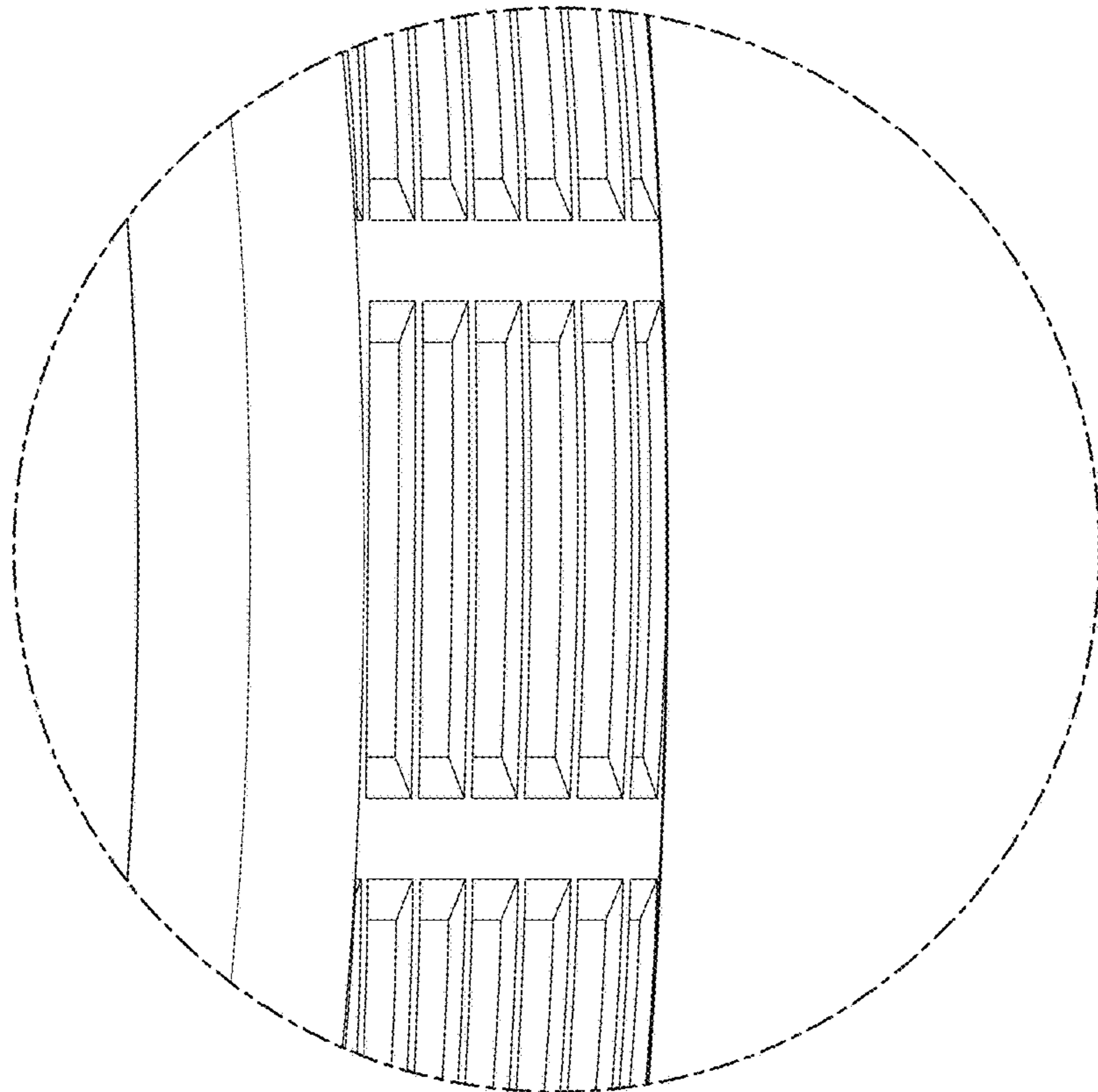

FIG. 26

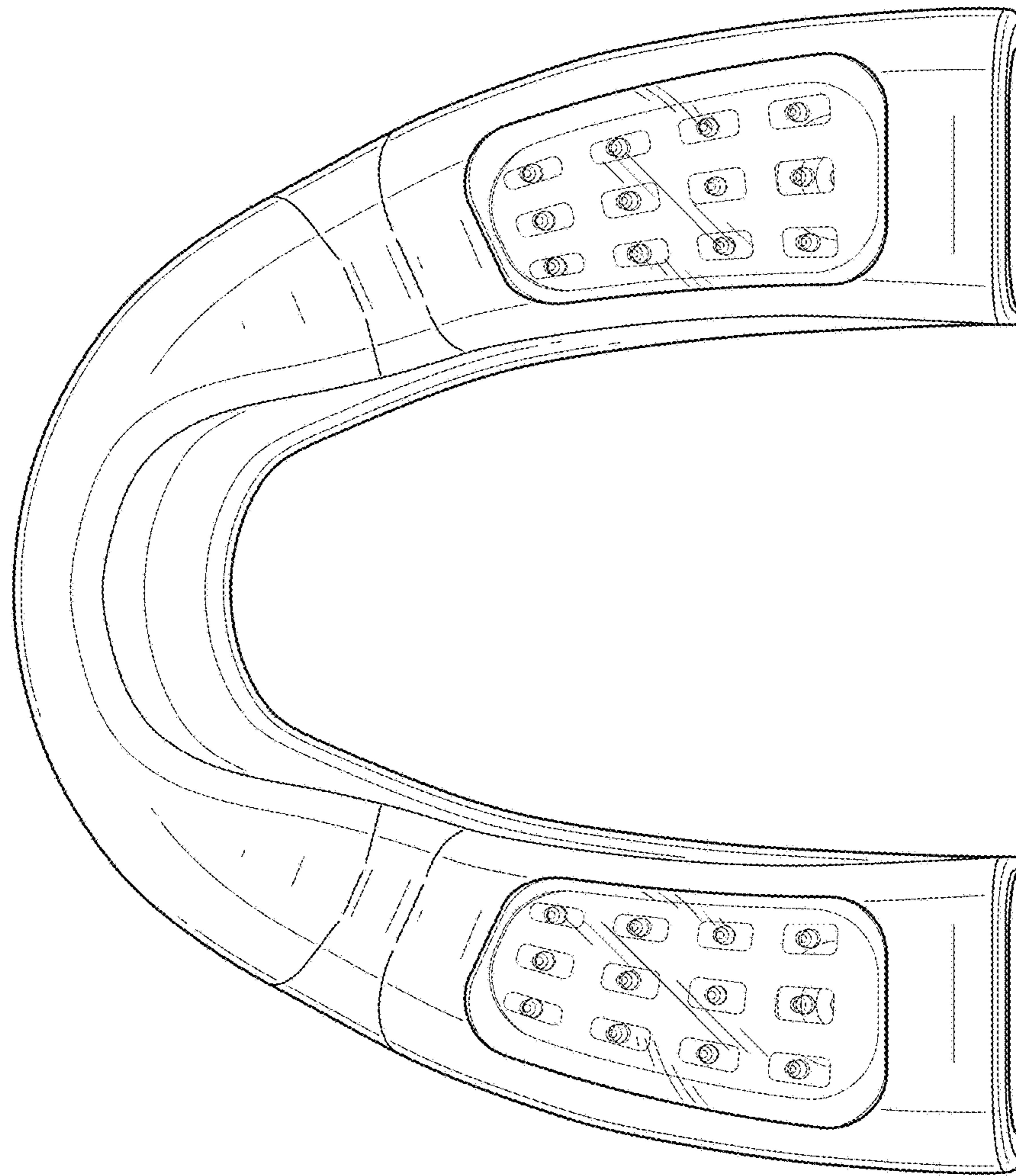

FIG. 27

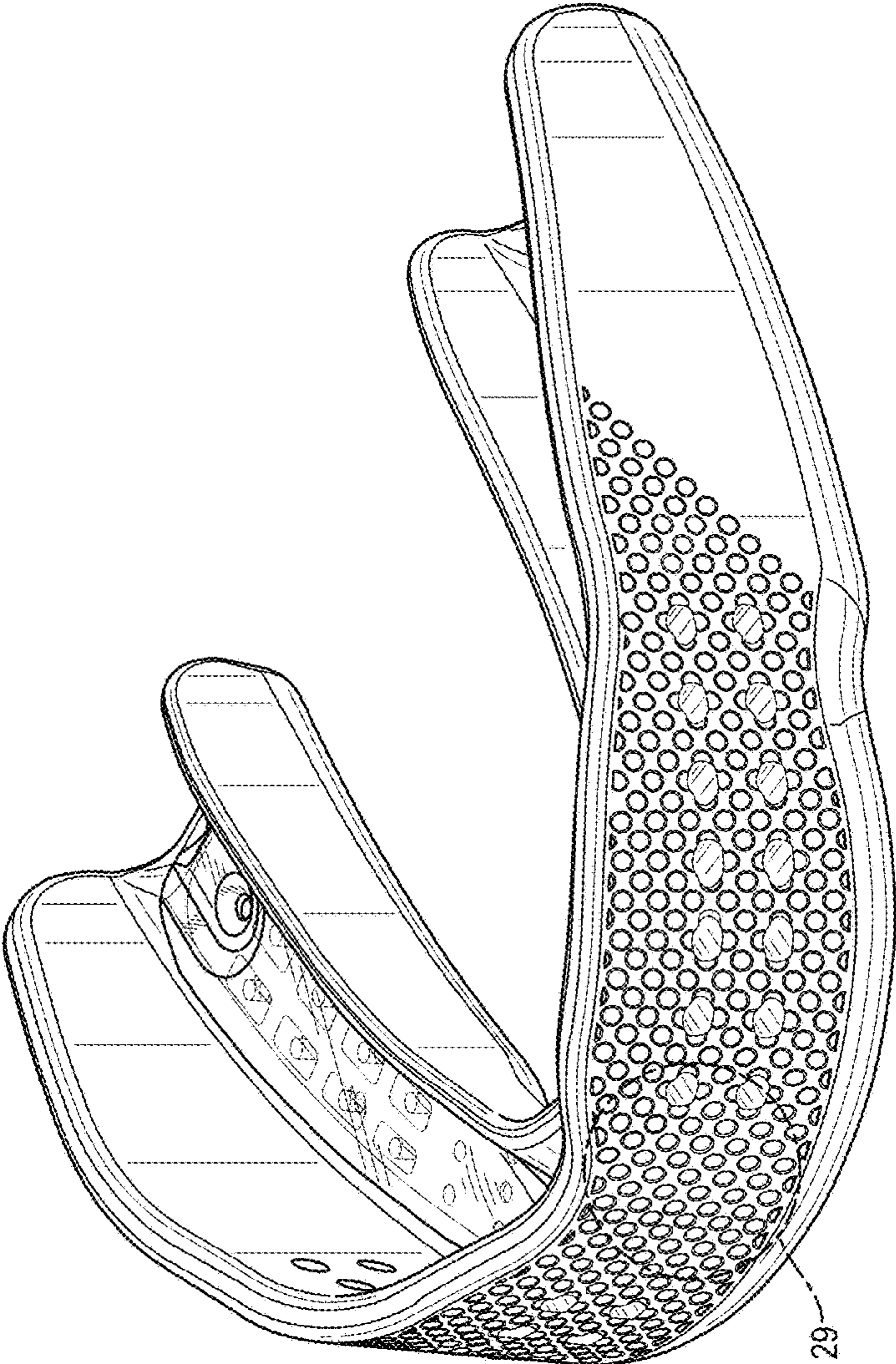

FIG. 28

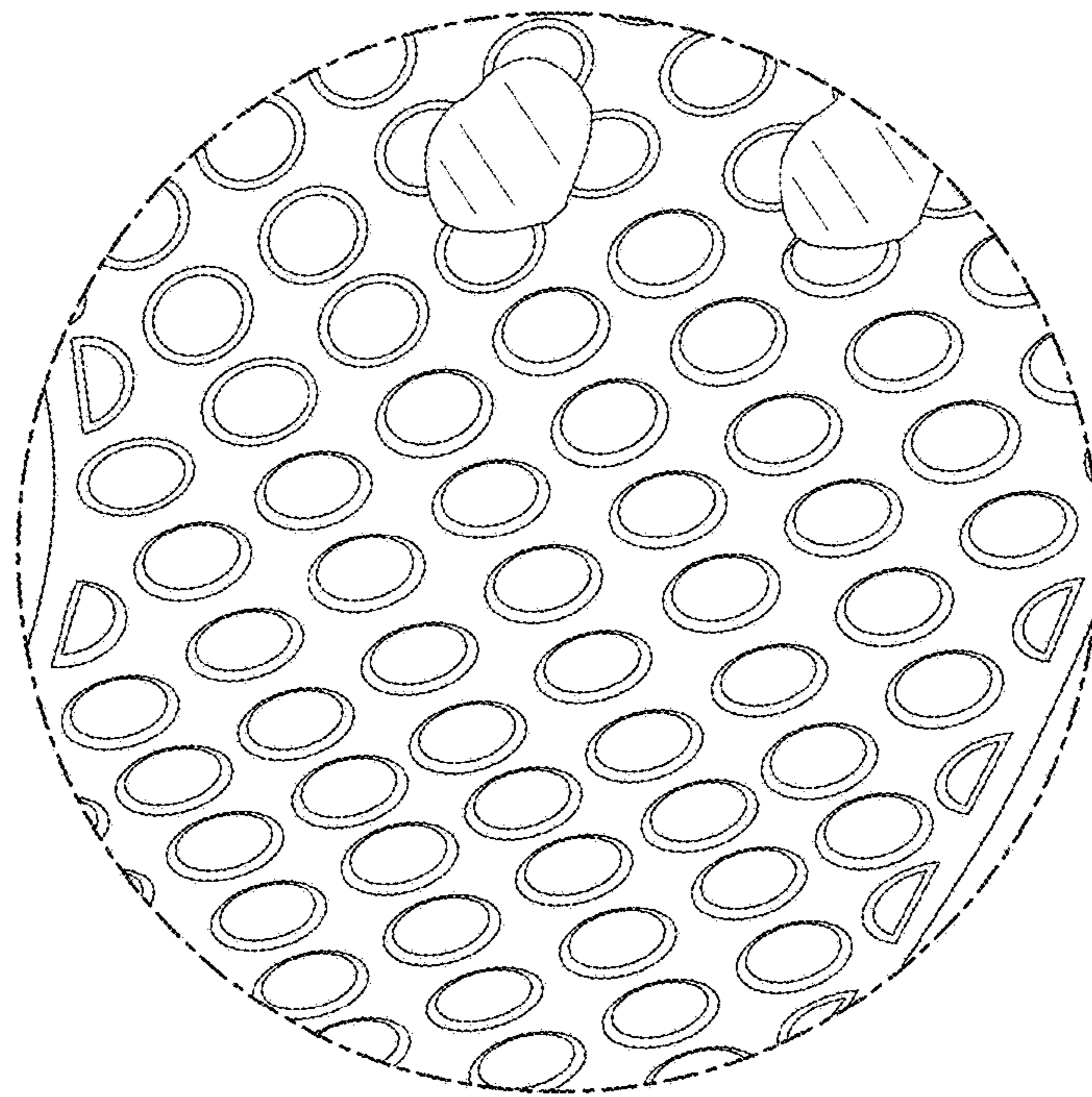

FIG. 29

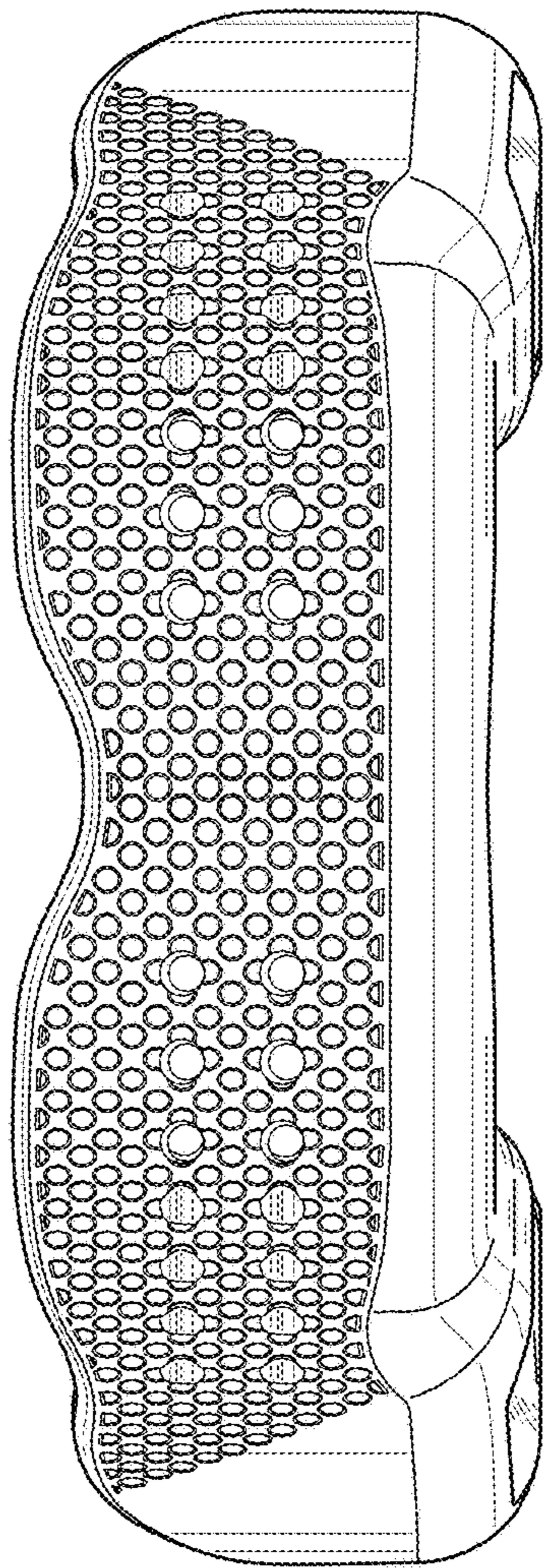

FIG. 30



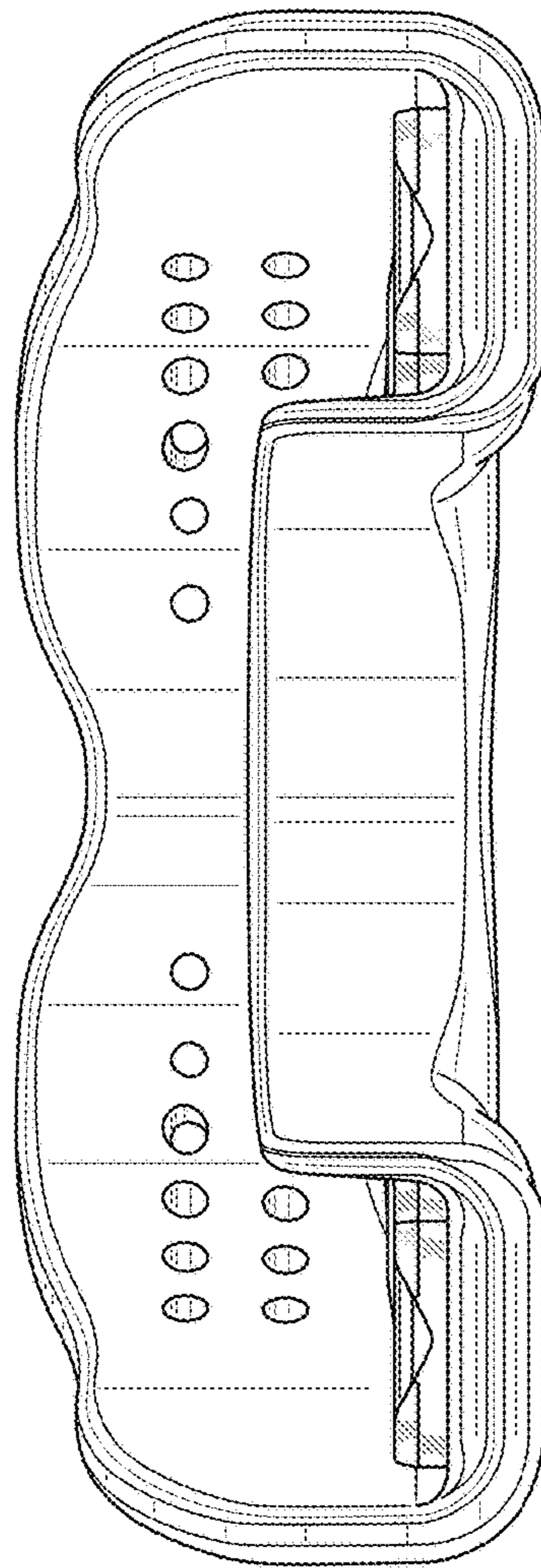

FIG. 31

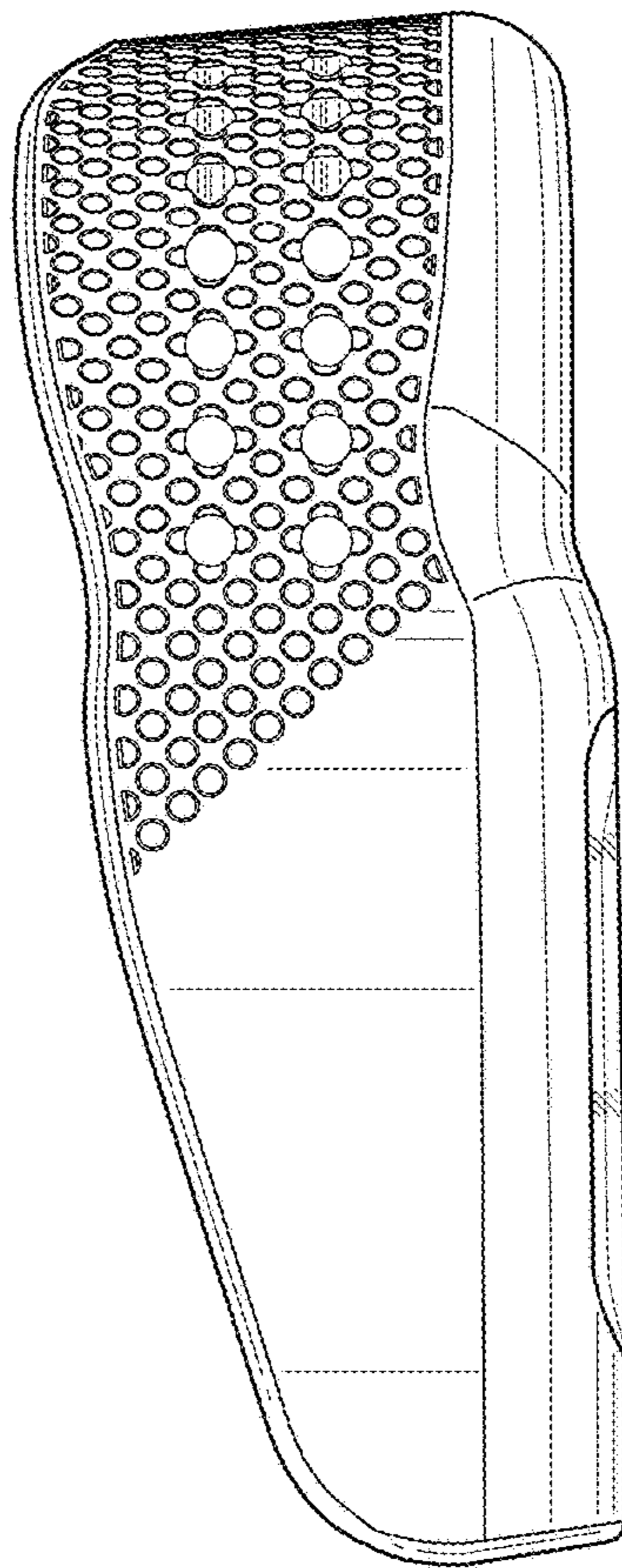

FIG. 32

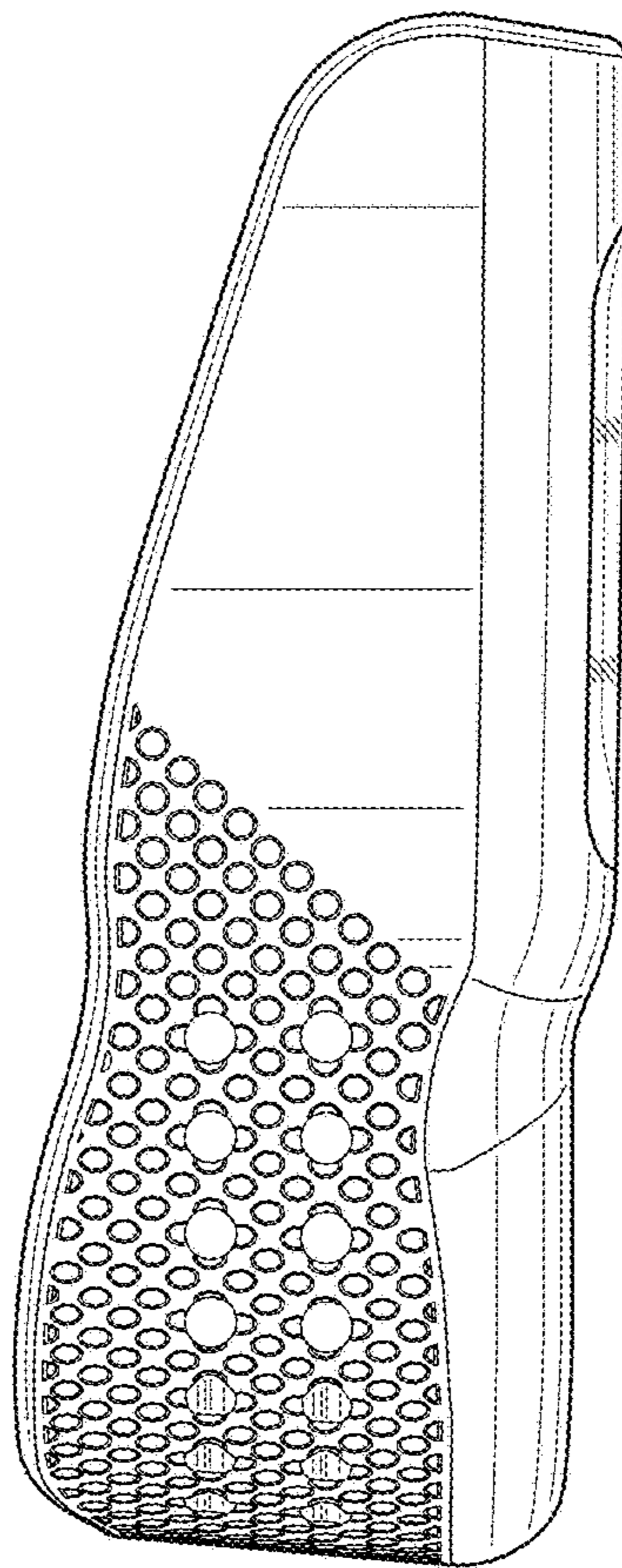
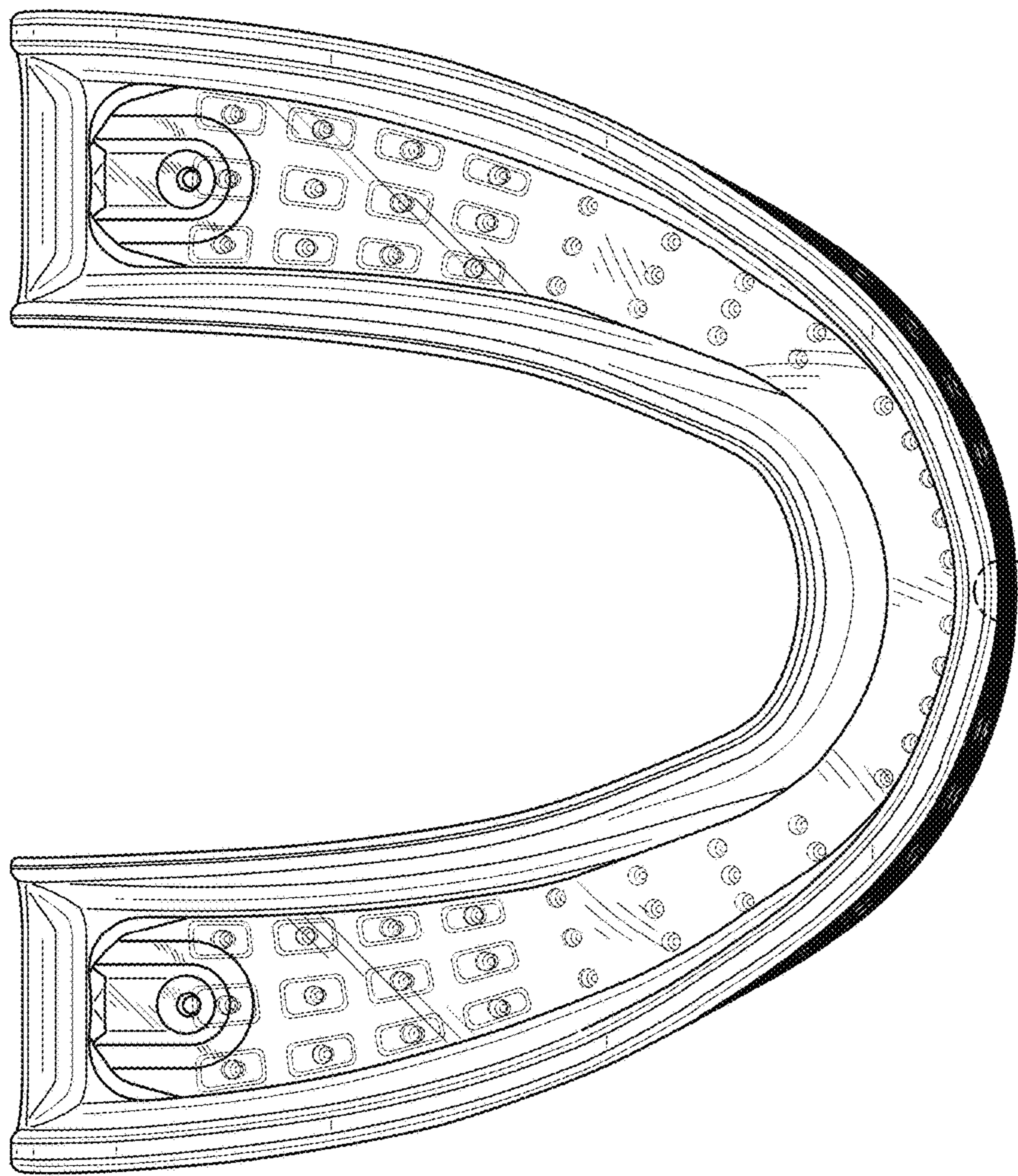

FIG. 33



35  
FIG. 34

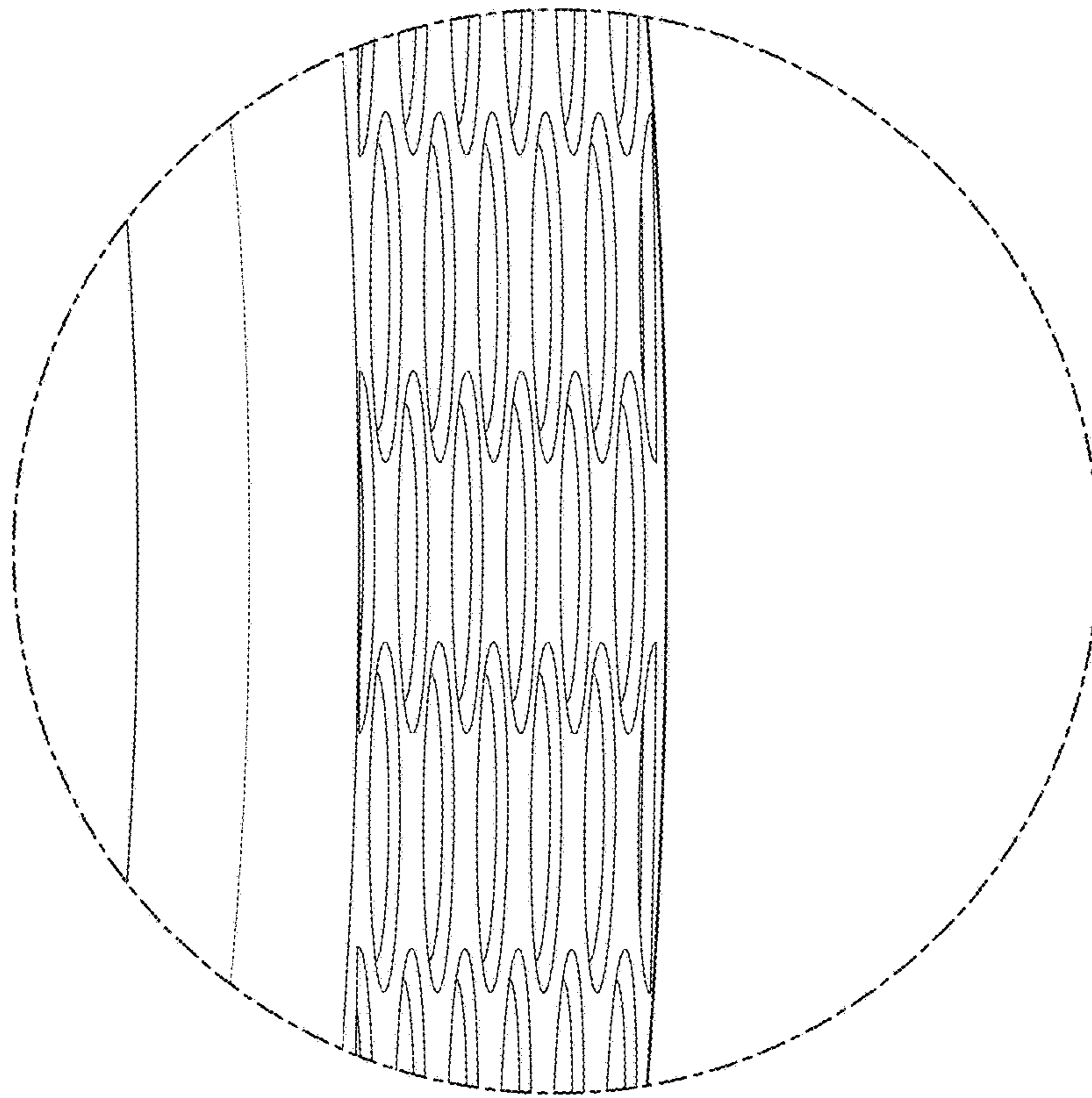

FIG. 35

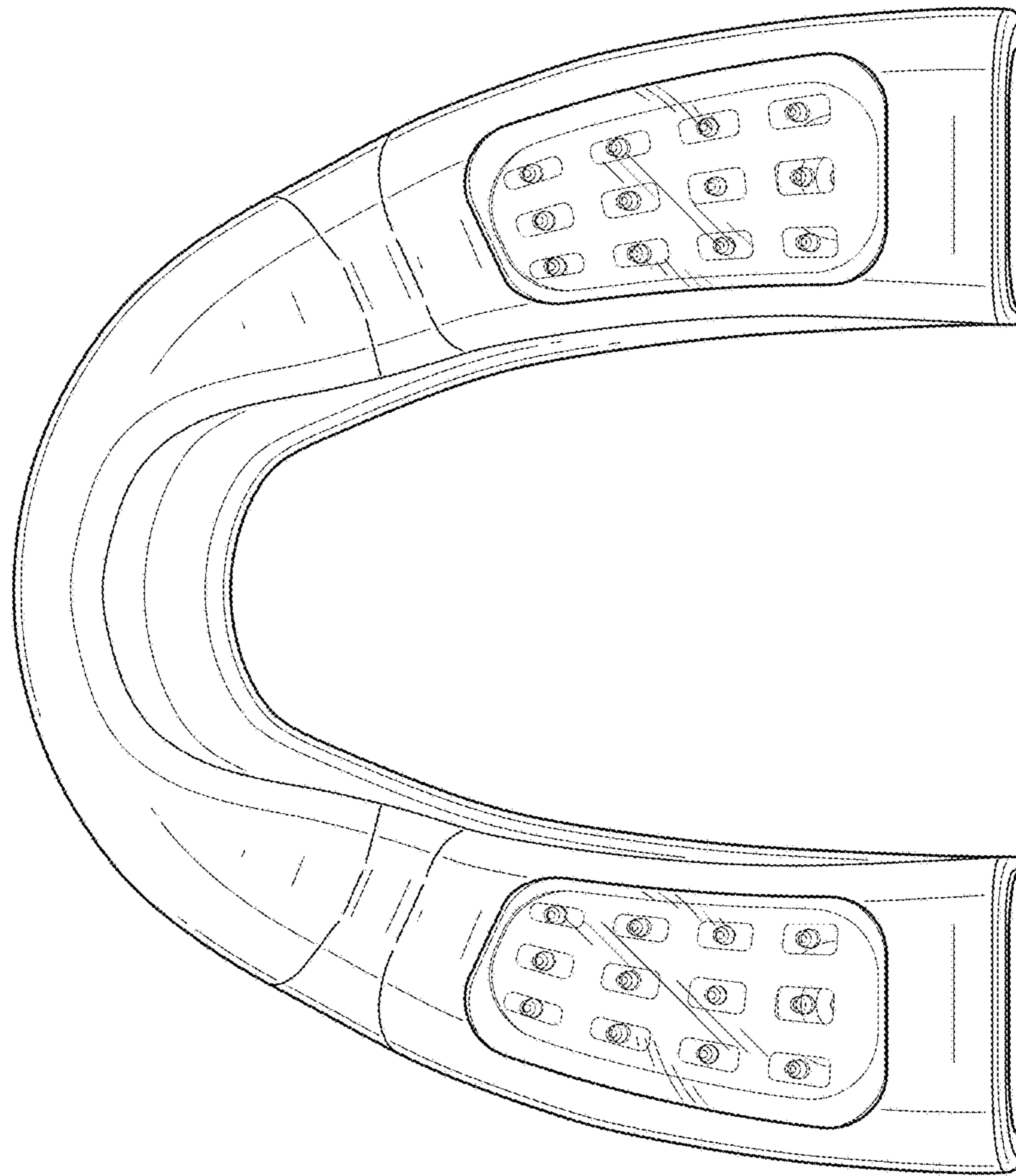

FIG. 36