



US00D857967S

(12) **United States Design Patent** (10) **Patent No.:** **US D857,967 S**
Neri (45) **Date of Patent:** **** Aug. 27, 2019**

(54) **PUBLIC LIGHTING FIXTURE**
(71) Applicant: **NERI S.P.A.**, Longiano (IT)
(72) Inventor: **Isacco Neri**, Longiano (IT)
(73) Assignee: **NERI S.P.A.** (IT)
(**) Term: **15 Years**
(21) Appl. No.: **35/505,050**
(22) Filed: **Dec. 5, 2017**

D563,015 S * 2/2008 Lee D26/67
D643,964 S * 8/2011 Heyrman D26/85
D646,424 S * 10/2011 Ho D26/85
D694,932 S * 12/2013 Meyer D26/67
D734,531 S * 7/2015 Tragatschnig D26/118
D756,545 S * 5/2016 Goodsell D26/9
D770,073 S * 10/2016 Stern D26/67
D772,463 S * 11/2016 Stern D26/67
D783,882 S * 4/2017 Dolan D26/87
D785,223 S * 4/2017 Patton D26/67
D811,640 S * 2/2018 Kim D26/63
D827,183 S * 8/2018 Sonneman D26/85
D830,610 S * 10/2018 Amato D26/87
D836,819 S * 12/2018 Amato D26/85
2015/0328353 A1 * 11/2015 Schramm F21V 33/0032
392/393

(80) **Hague Agreement Data**
Int. Filing Date: **Dec. 5, 2017**
Int. Reg. No.: **DM/098913**
Int. Reg. Date: **Dec. 5, 2017**
Int. Reg. Pub. Date: **Jun. 8, 2018**

* cited by examiner

Primary Examiner — George D. Kirschbaum
Assistant Examiner — Natasha Vujcic
(74) *Attorney, Agent, or Firm* — The Belles Group, P.C.

(51) **LOC (12) Cl.** **26-05**
(52) **U.S. Cl.**
USPC **D26/85**
(58) **Field of Classification Search**
USPC D26/76, 78, 79, 80, 81, 82, 83, 85, 86,
D26/88, 90, 93, 111, 113, 118, 119, 120,
D26/121, 122, 138, 139, 140, 141, 142,
D26/152
CPC F21S 2/00; F21S 4/00; F21S 4/003; F21S
4/005; F21S 4/006; F21S 4/007; F21S
4/008; F21S 6/00; F21S 8/00; F21S
8/024; F21S 8/026; F21S 8/031; F21S
8/033; F21S 8/035-037; F21S 8/04; F21S
8/043; F21S 8/063
See application file for complete search history.

(57) **CLAIM**

The ornamental design for a public lighting fixture, as shown and described.

DESCRIPTION

- 1. Public lighting fixture
- 1.1 : front/side perspective view
- 1.2 : left side elevation view
- 1.3 : right side elevation view
- 1.4 : rear side elevation view
- 1.5 : front side elevation view
- 1.6 : top plan view
- 1.7 : bottom plan view

The broken lines in the drawings illustrate portions of the public lighting fixture which forms no part of the claimed design.

(56) **References Cited**
U.S. PATENT DOCUMENTS

D445,210 S * 7/2001 Chen D26/72
D548,895 S * 8/2007 Barszcz D30/125

1 Claim, 7 Drawing Sheets

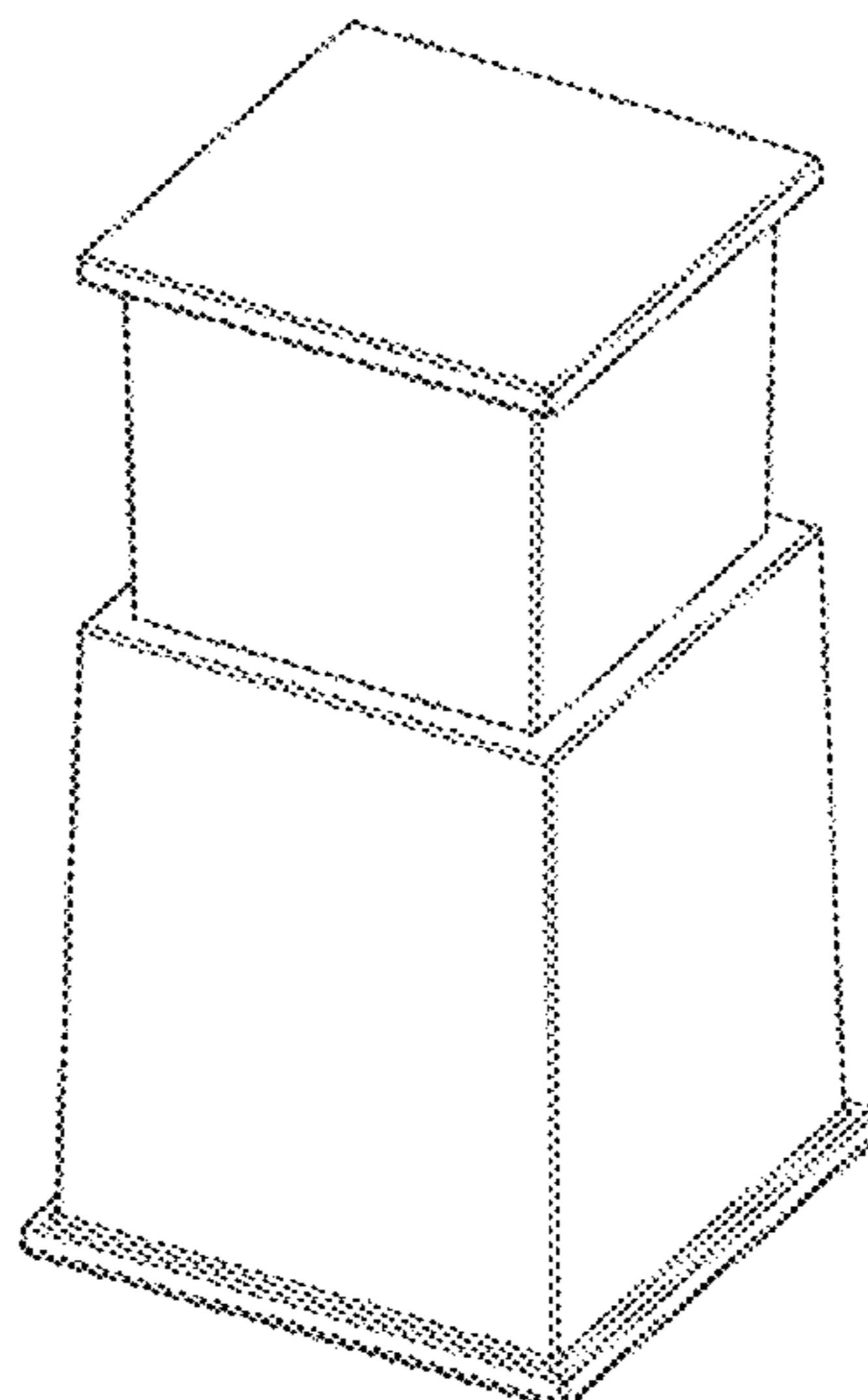

1.1

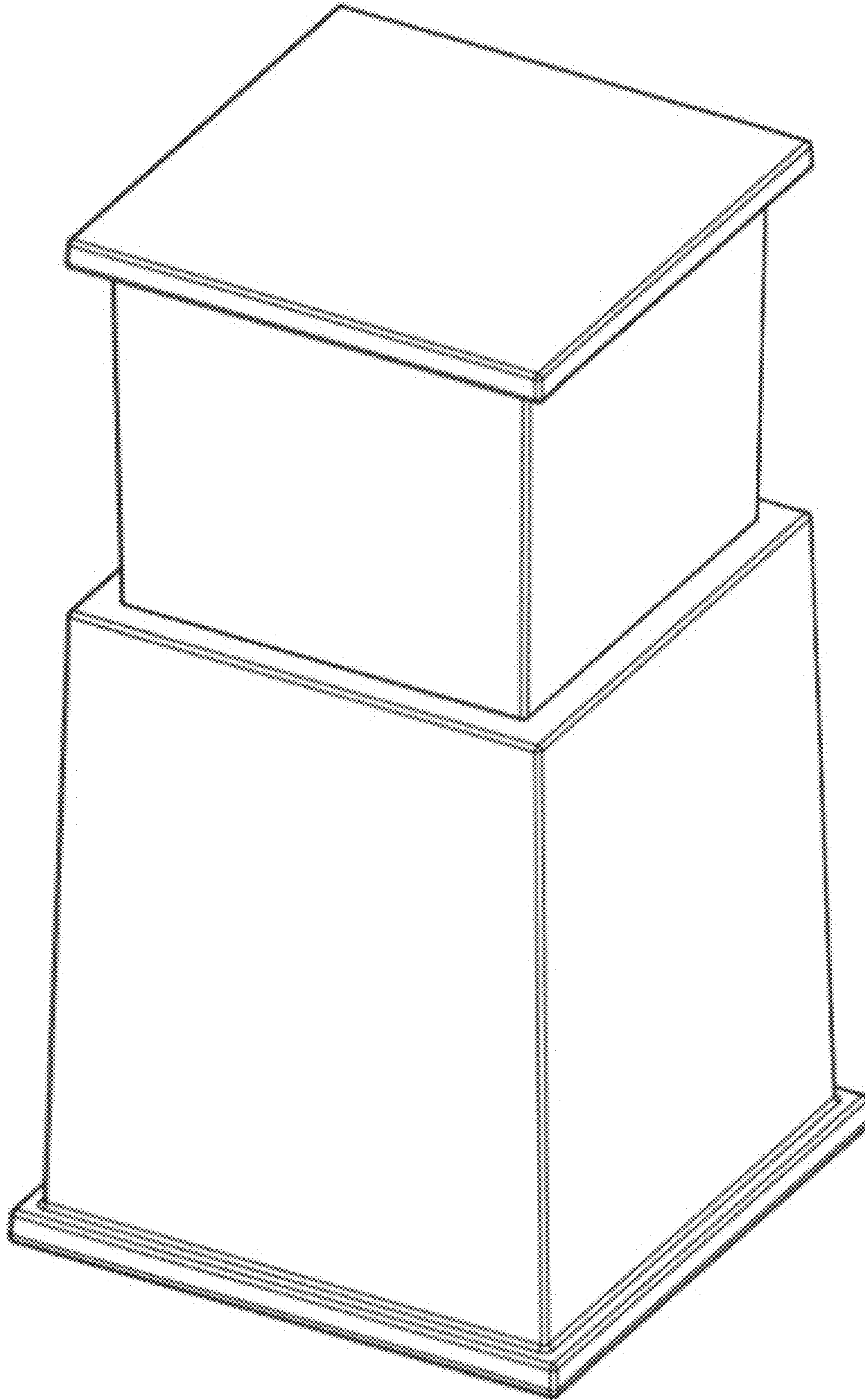

1.2

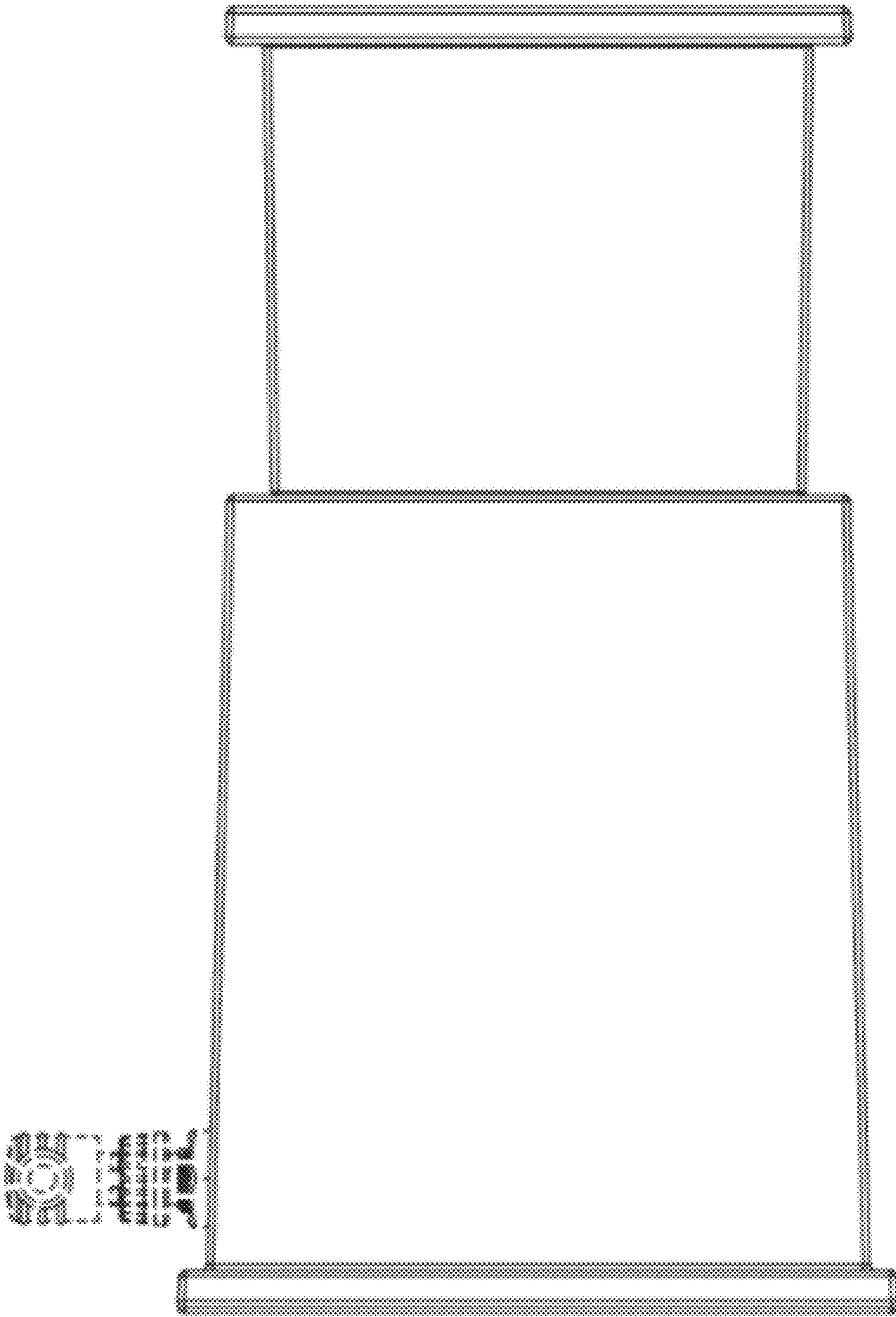

1.3

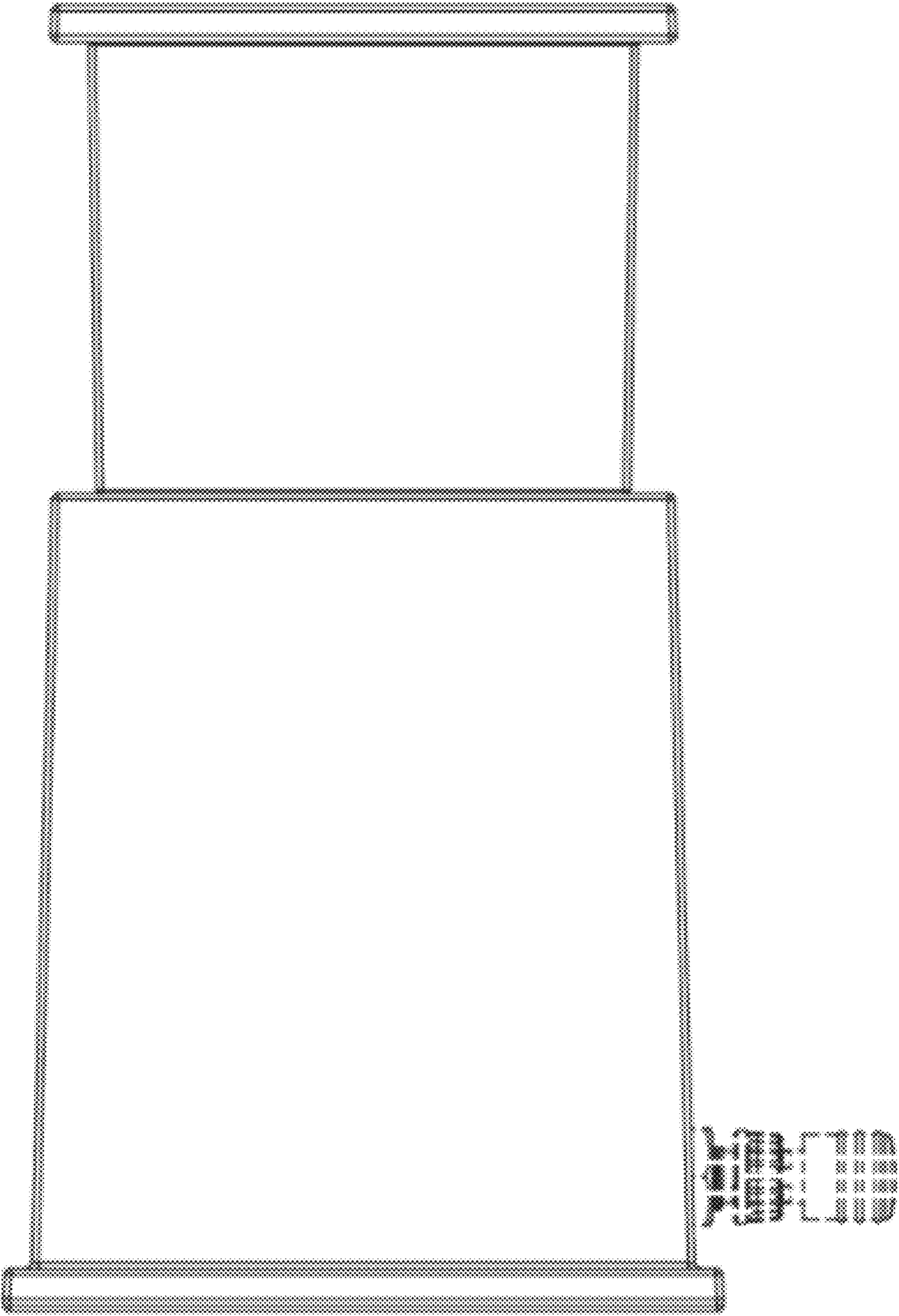

1.4

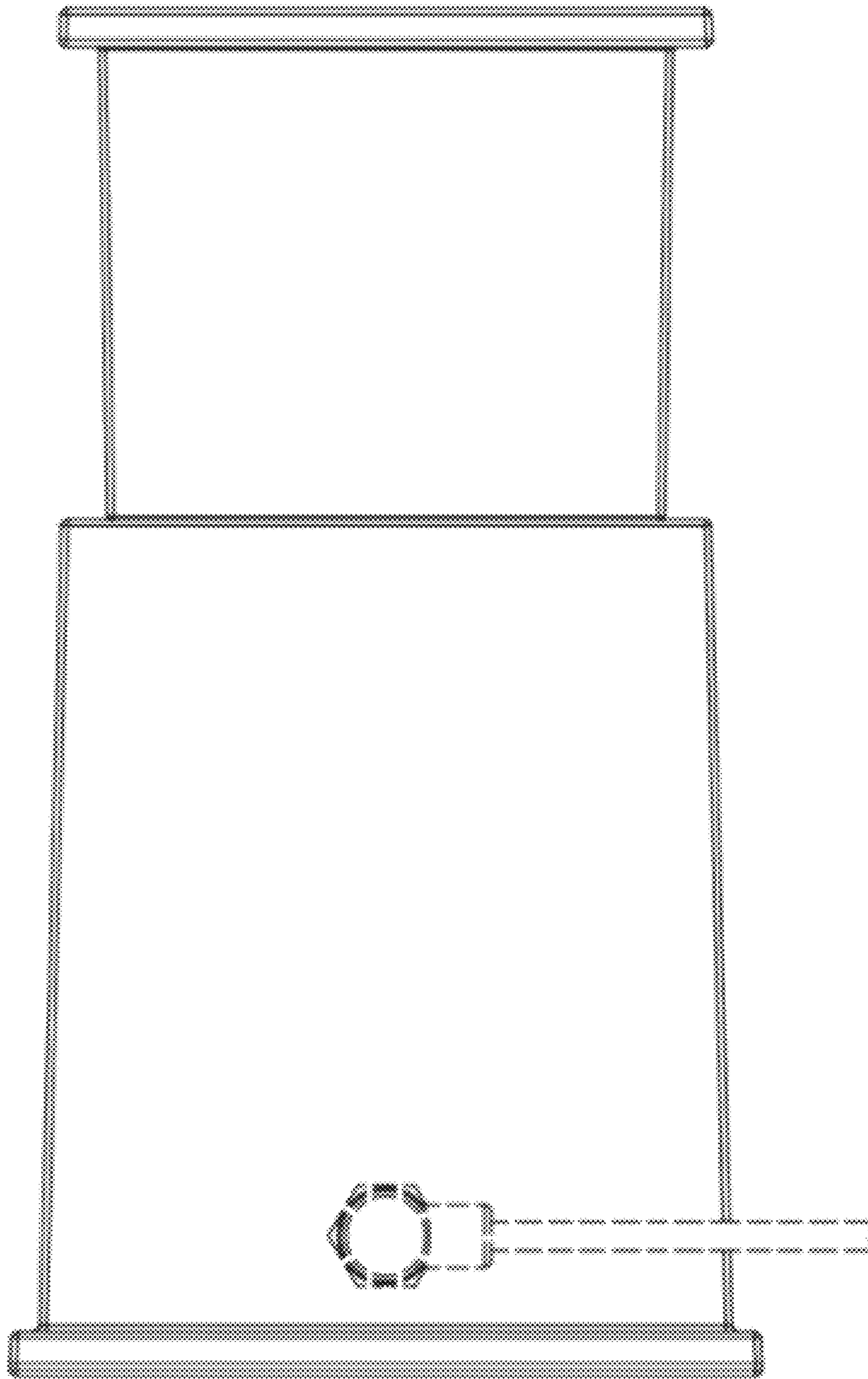

1.5

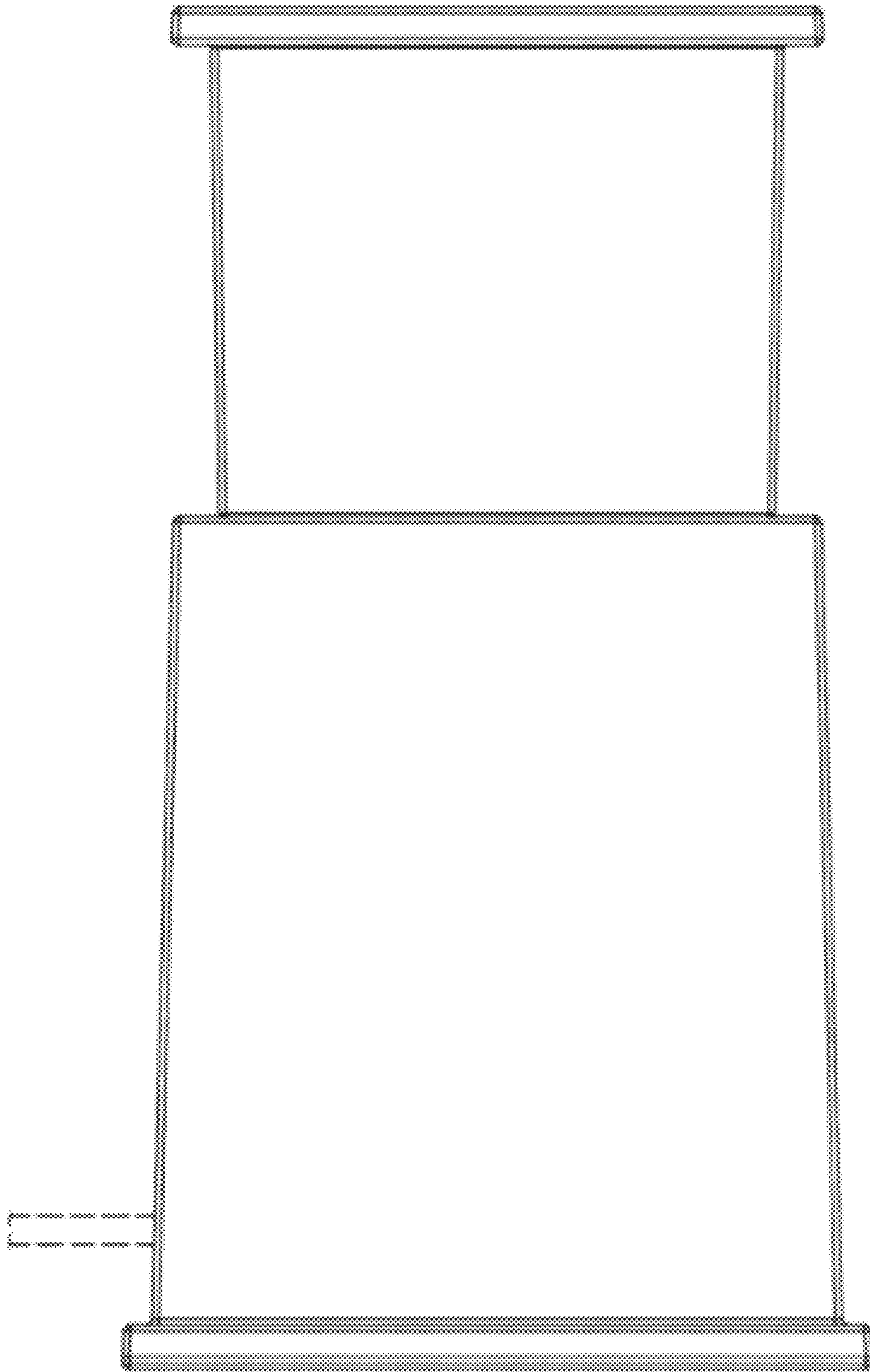

1.6

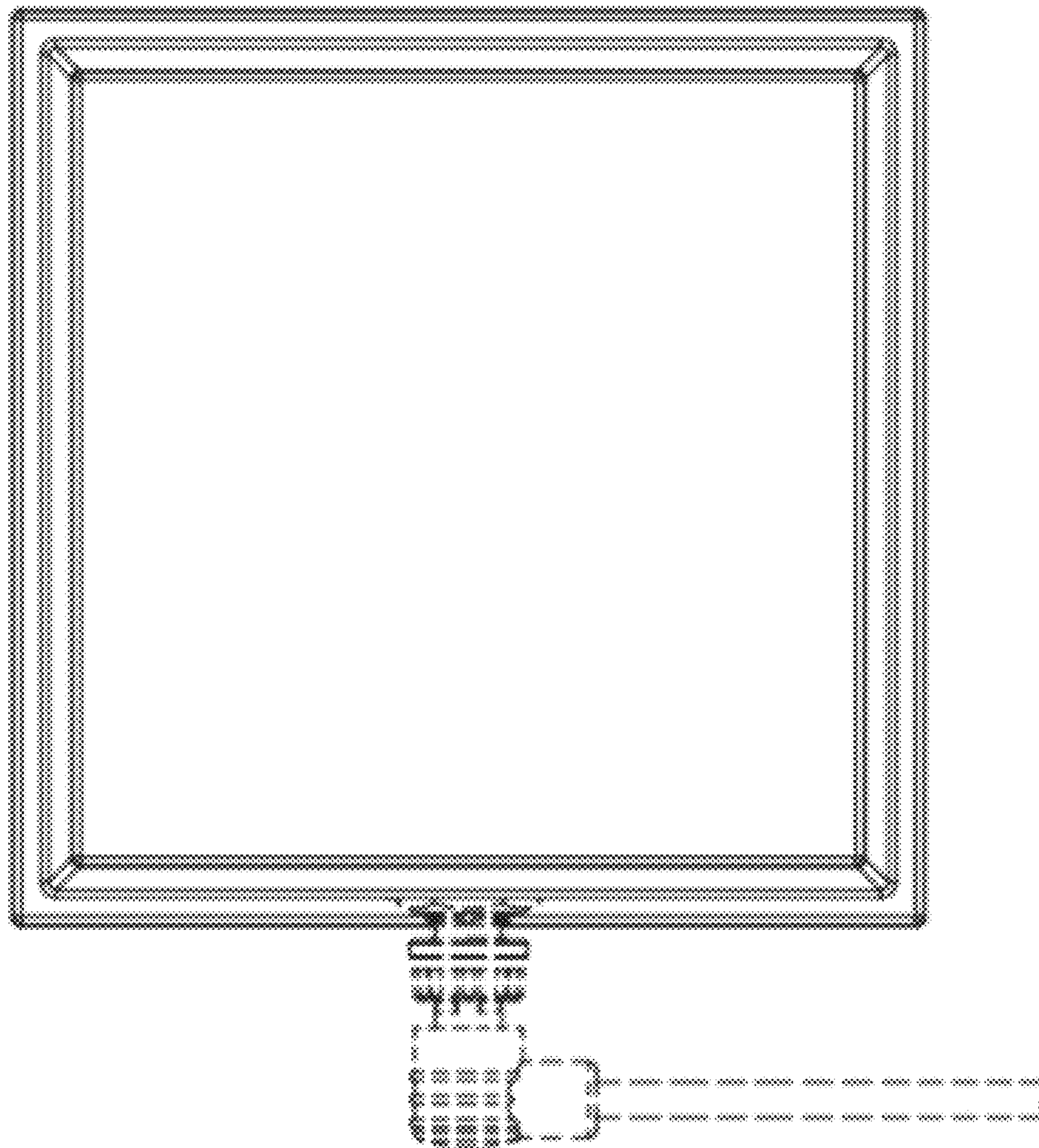

1.7

