



US00D857865S

(12) **United States Design Patent** (10) **Patent No.:** **US D857,865 S**
Wang (45) **Date of Patent:** **** Aug. 27, 2019**

- (54) **BRAZIER HEATER**
- (71) Applicant: **Pengyu Wang**, Changzhou (CN)
- (72) Inventor: **Pengyu Wang**, Changzhou (CN)
- (**) Term: **15 Years**
- (21) Appl. No.: **29/584,585**
- (22) Filed: **Nov. 16, 2016**

(30) **Foreign Application Priority Data**

Aug. 30, 2016 (CN) 2016 3 0442280

- (51) **LOC (12) Cl.** **23-03**
- (52) **U.S. Cl.**
USPC **D23/339**
- (58) **Field of Classification Search**
USPC D7/337, 338, 339, 340; D23/335, 336,
D23/337, 338, 339
CPC ... G05D 7/00; F24F 13/07; F24B 3/00; F23N
5/22; B60H 3/00; B32B 15/04; A62C
3/00; A47J 43/18; A47J 37/00; A47J
37/04; A47J 37/06; A47J 37/07; F24C
1/00; F24C 5/00; F24C 5/20; F24C 3/00;
F24C 3/10; F24C 3/12; F24C 15/06;
F24C 15/10; F24C 15/16; F24C 15/20
See application file for complete search history.

(56) **References Cited**

U.S. PATENT DOCUMENTS

- 1,421,393 A * 7/1922 Boyle F24B 1/205
126/29
- D85,354 S * 10/1931 Teller et al. 126/37 R
- D130,988 S * 12/1941 Howard D7/337
- D187,095 S * 1/1960 Joseph D7/337
- D200,683 S * 3/1965 Temperato D7/338
- D282,139 S * 1/1986 Radford D7/337
- 5,865,129 A * 2/1999 Samples A47B 3/12
108/157.17
- D643,517 S * 8/2011 Napier D23/342
- D747,911 S * 1/2016 Sheppard D34/14

(Continued)

Primary Examiner — Karen S Acker
Assistant Examiner — Steven B Reinholdt, Jr.
(74) *Attorney, Agent, or Firm* — Gokalp Bayramoglu

(57) **CLAIM**

The ornamental design for a brazier heater, as shown and described.

DESCRIPTION

FIG. 1 is a perspective view of a brazier heater showing the new design;
 FIG. 2 is a front view thereof;
 FIG. 3 is a rear view thereof;
 FIG. 4 is a top view thereof;
 FIG. 5 is a bottom view thereof;
 FIG. 6 is a left side view thereof;
 FIG. 7 is a right side view thereof;
 FIG. 8 is a fly enlarged view of the indicated area “8” in the FIG. 2;
 FIG. 9 is a partially enlarged view of the indicated area “9” in the FIG. 1;
 FIG. 10 is a partially enlarged view of the indicated area “10” in the FIG. 4;
 FIG. 11 is a partially enlarged view of the indicated area “11” in the FIG. 6;
 FIG. 12 is a partially enlarged view of the indicated area “12” in the FIG. 6; and,
 FIG. 13 is a partially enlarged view of the indicated area “13” in the FIG. 7.

The broken lines showing the object in the interior of the brazier heater depict environmental subject matter only and form no part of the claim, while all other broken lines in the drawings depict portions of the brazier heater that form no part of the claimed design. The dot-dash broken lines depict boundaries of the partially enlarged areas of the corresponding drawing that form no part of the claimed design.

1 Claim, 12 Drawing Sheets

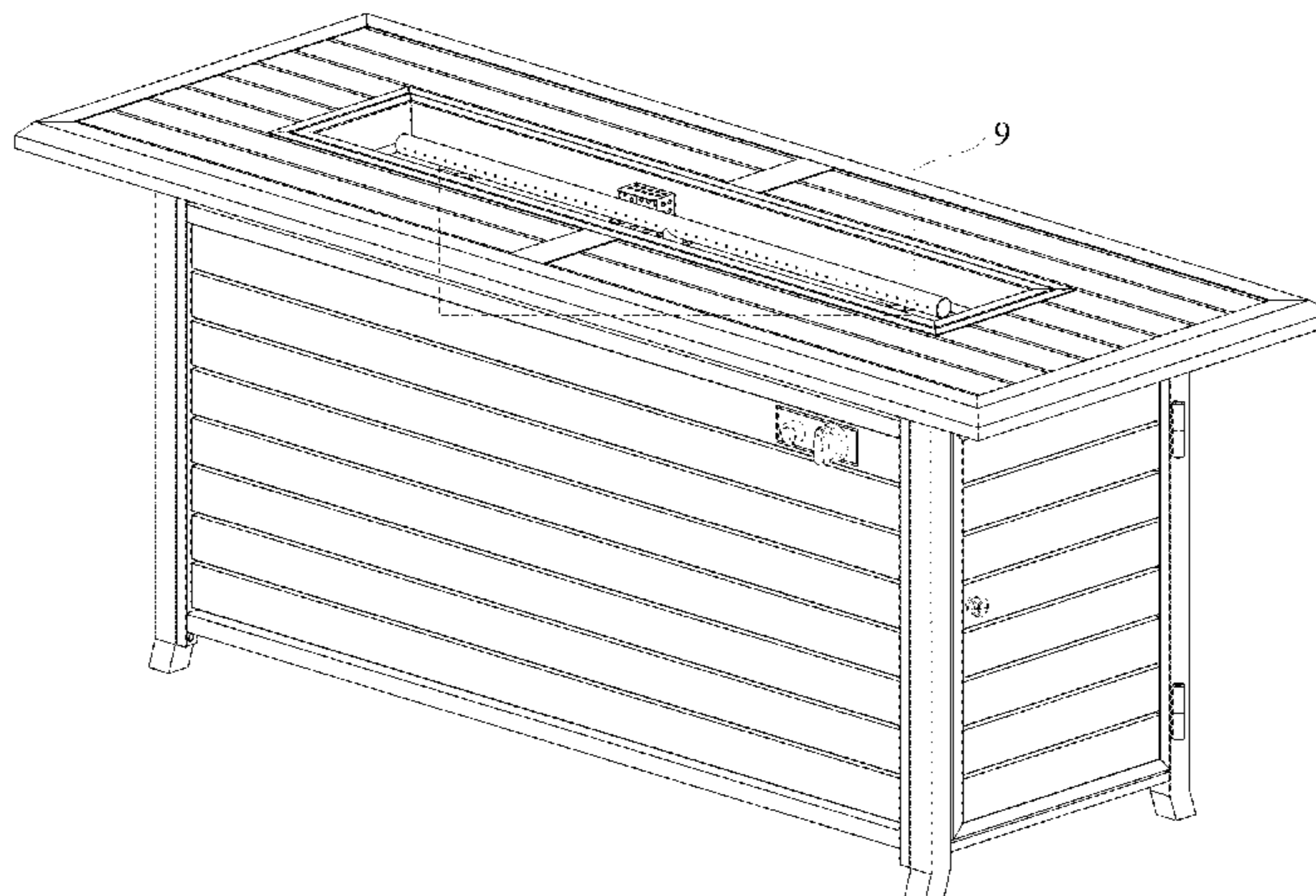

(56)

References Cited

U.S. PATENT DOCUMENTS

D769,668 S * 10/2016 Lally D7/334
D811,153 S * 2/2018 Mansueto D7/334
D815,483 S * 4/2018 Ruiz D7/332
2015/0013664 A1* 1/2015 Riel A47J 37/0781
126/506
2016/0302617 A1* 10/2016 Rogge A47B 31/02
2018/0010807 A1* 1/2018 Brakhage F24C 15/06

* cited by examiner

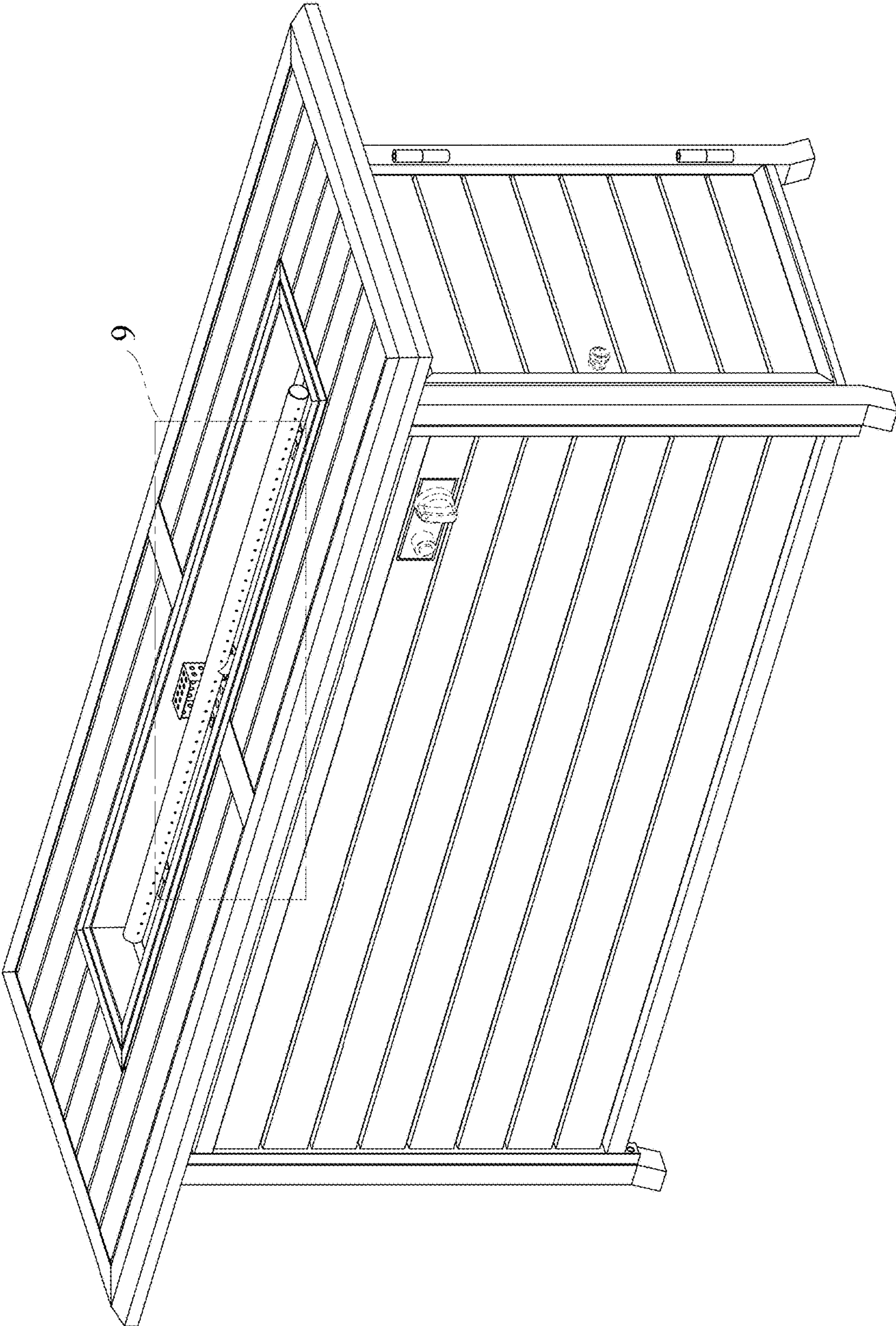

FIG. 1

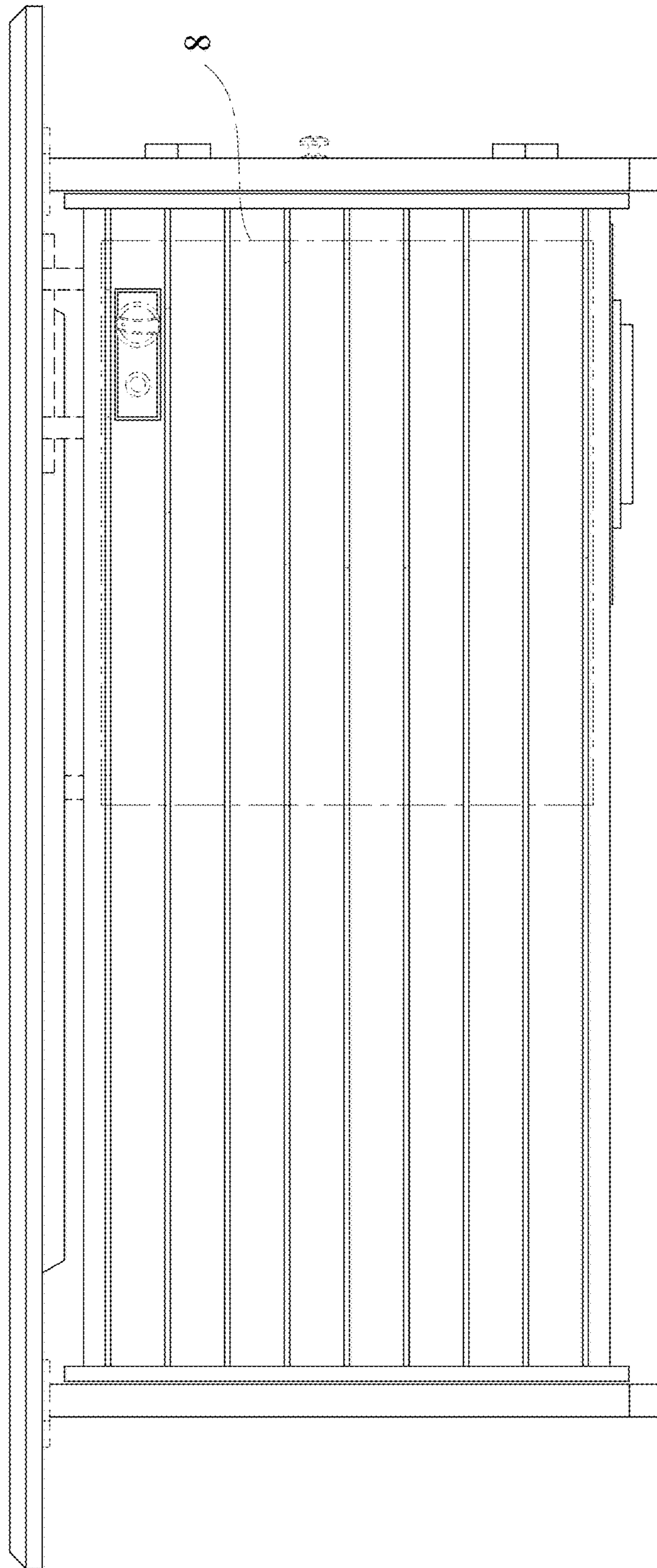

FIG. 2

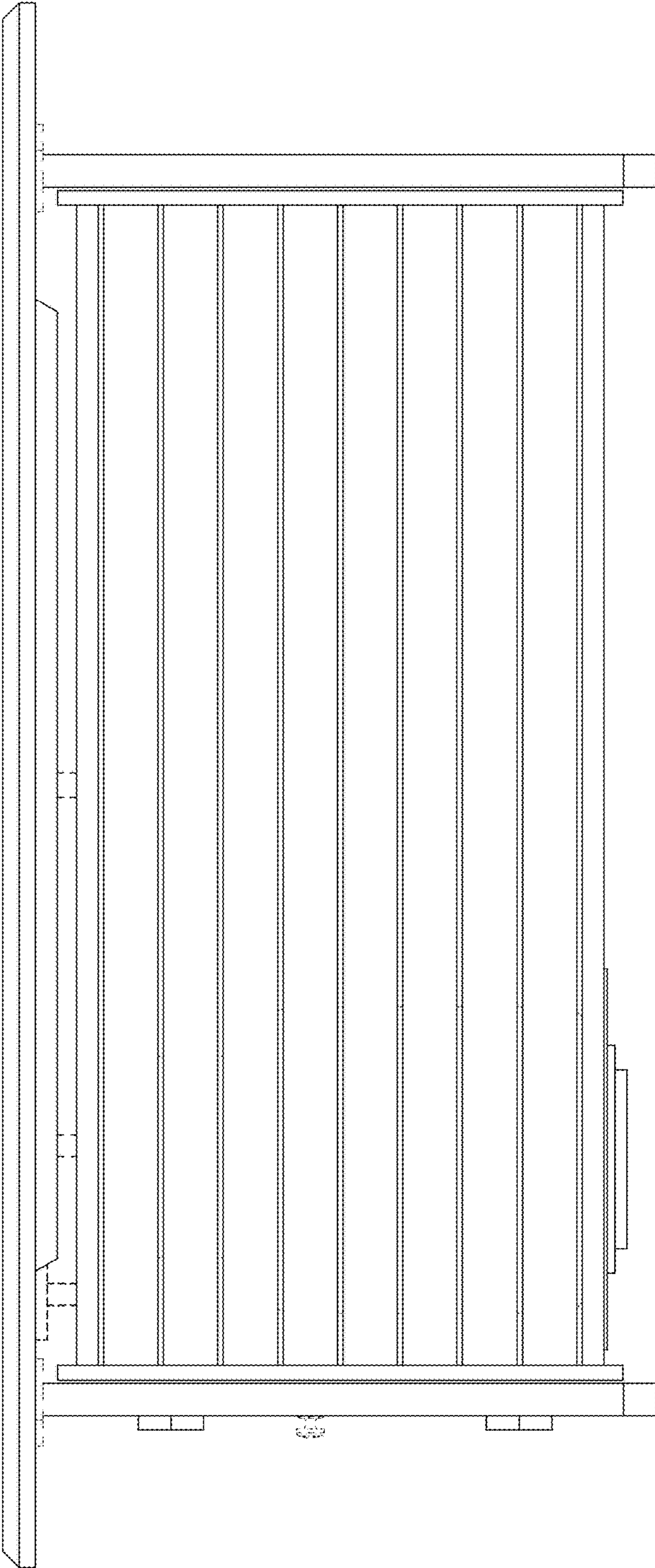

FIG. 3

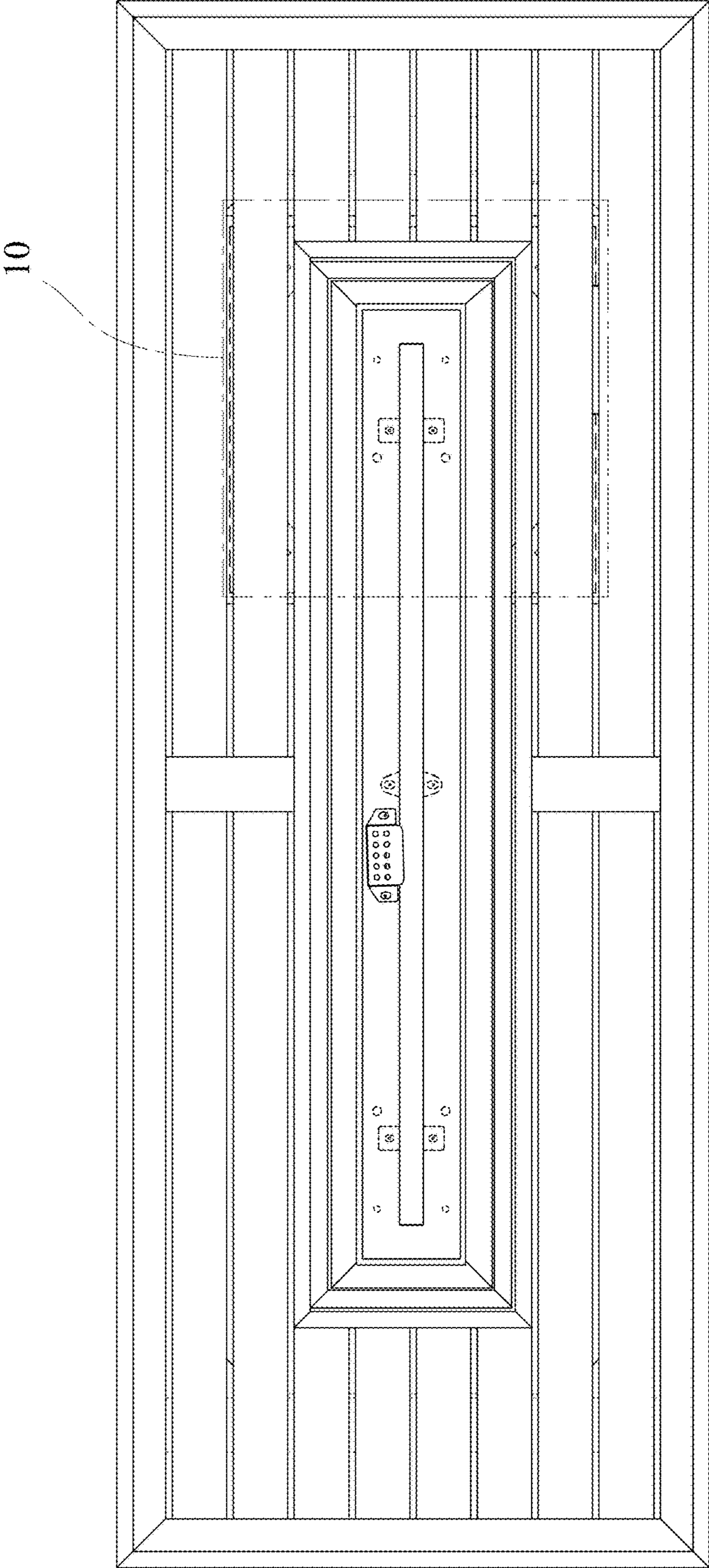

FIG. 4

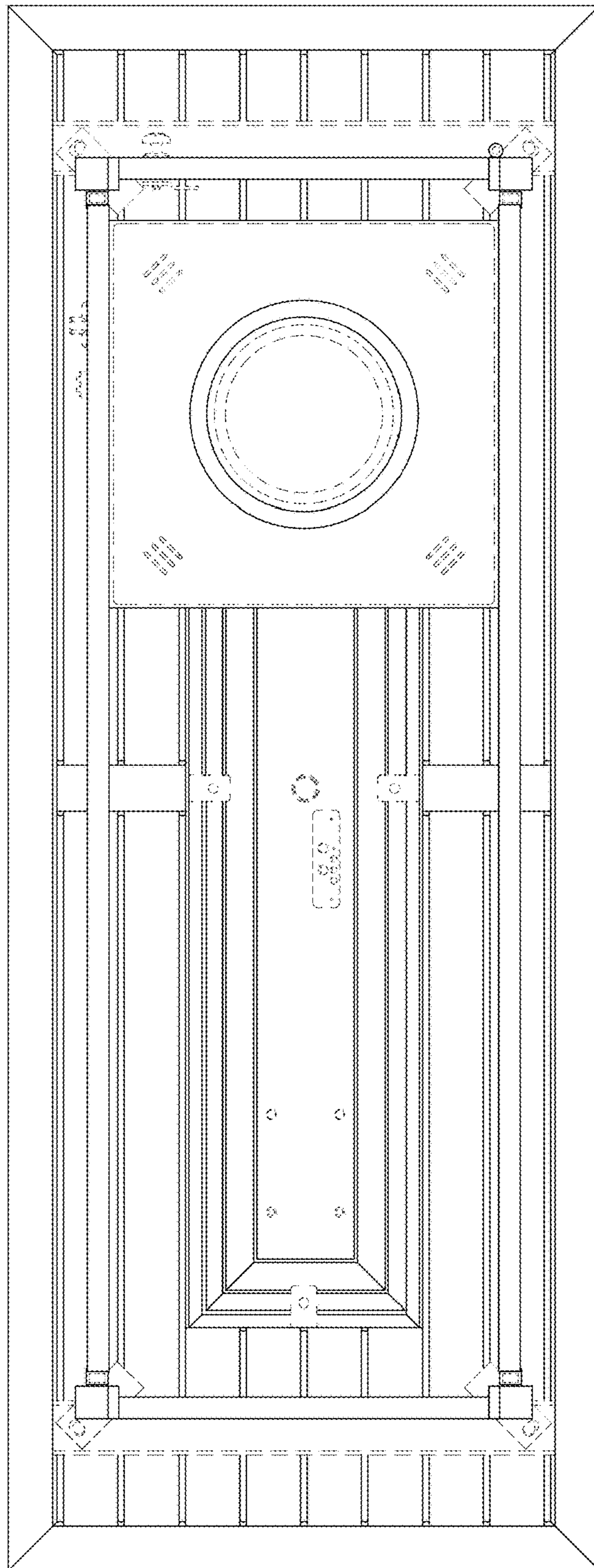

FIG. 5

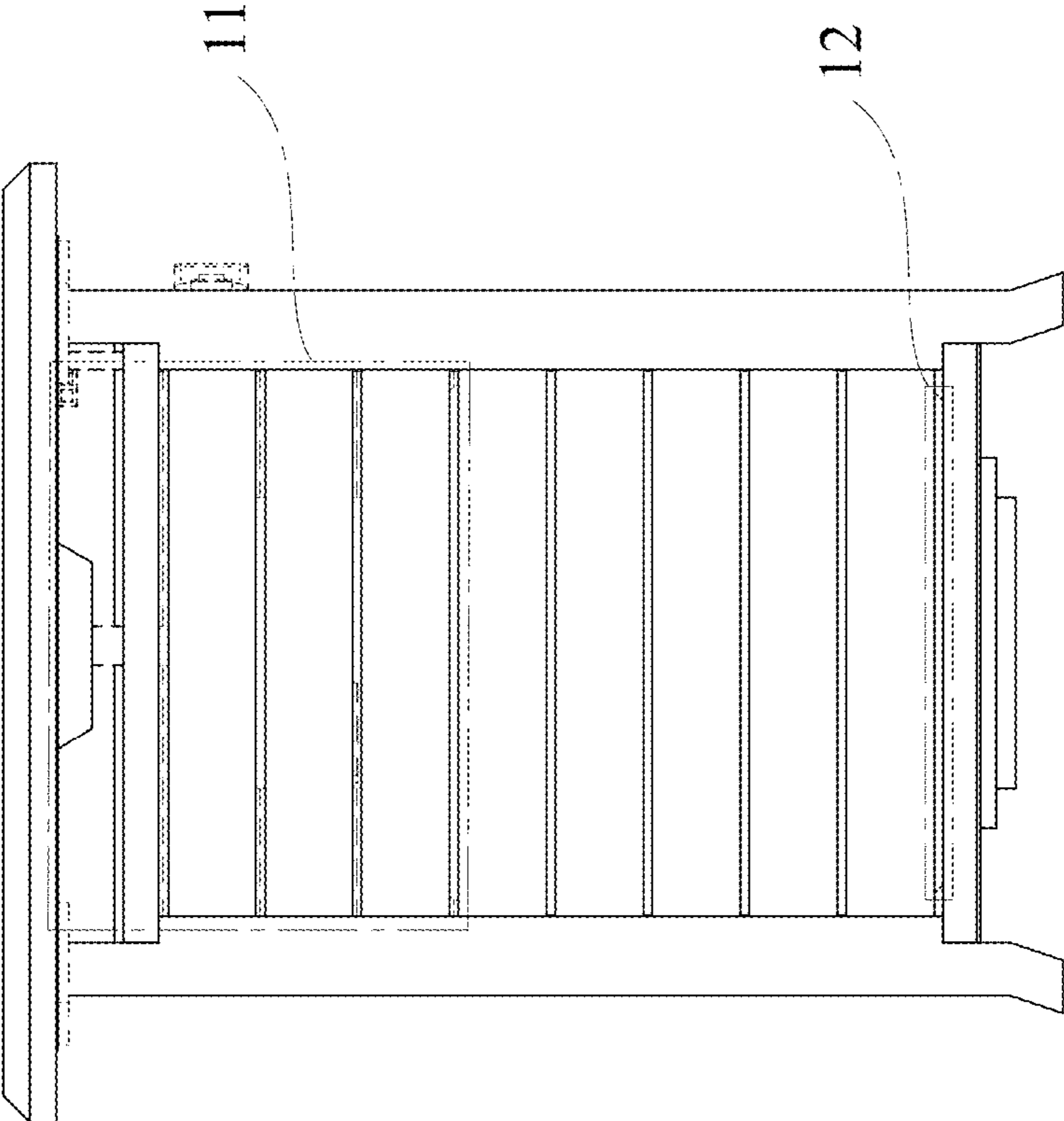

FIG. 6

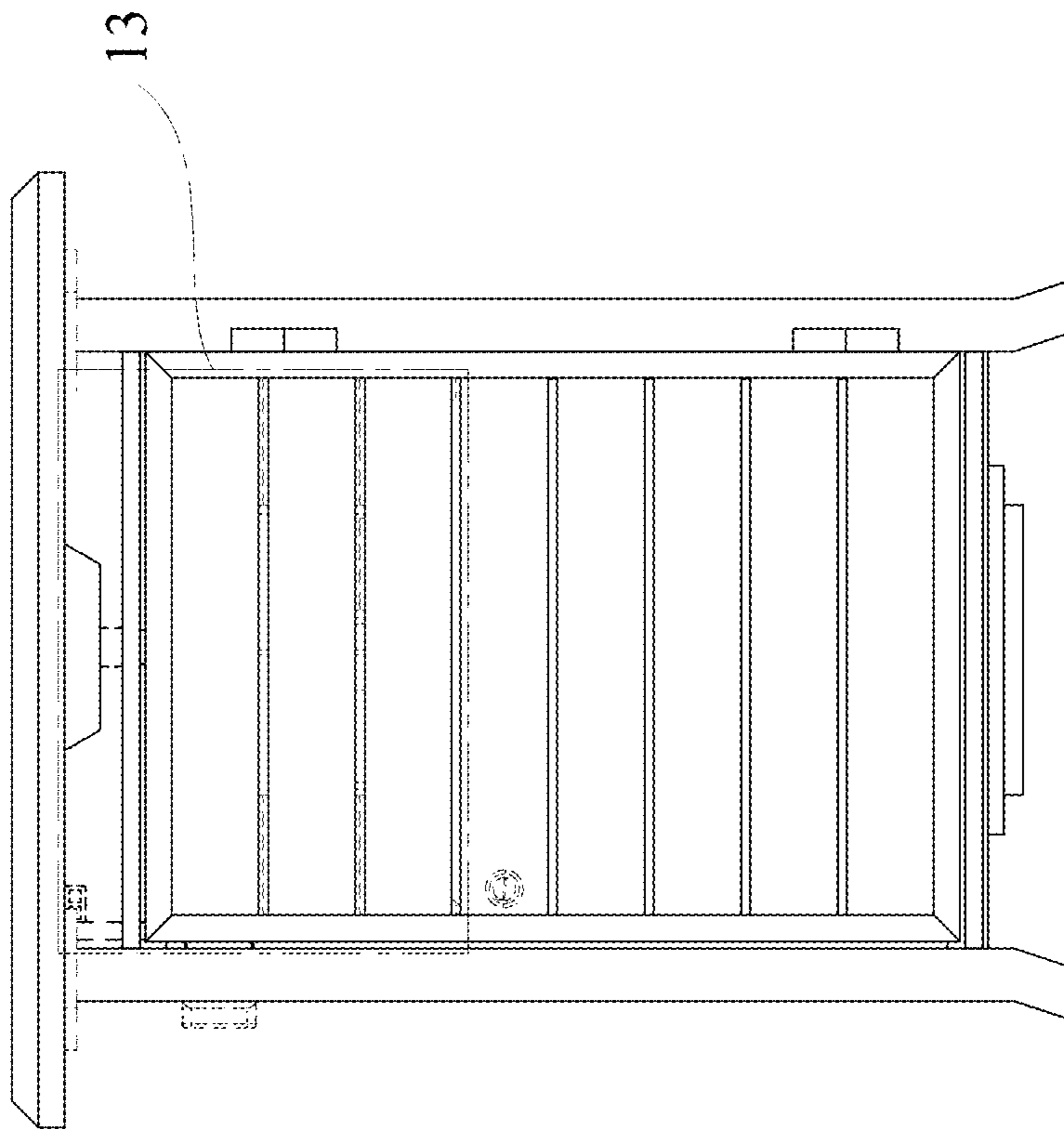

FIG. 7

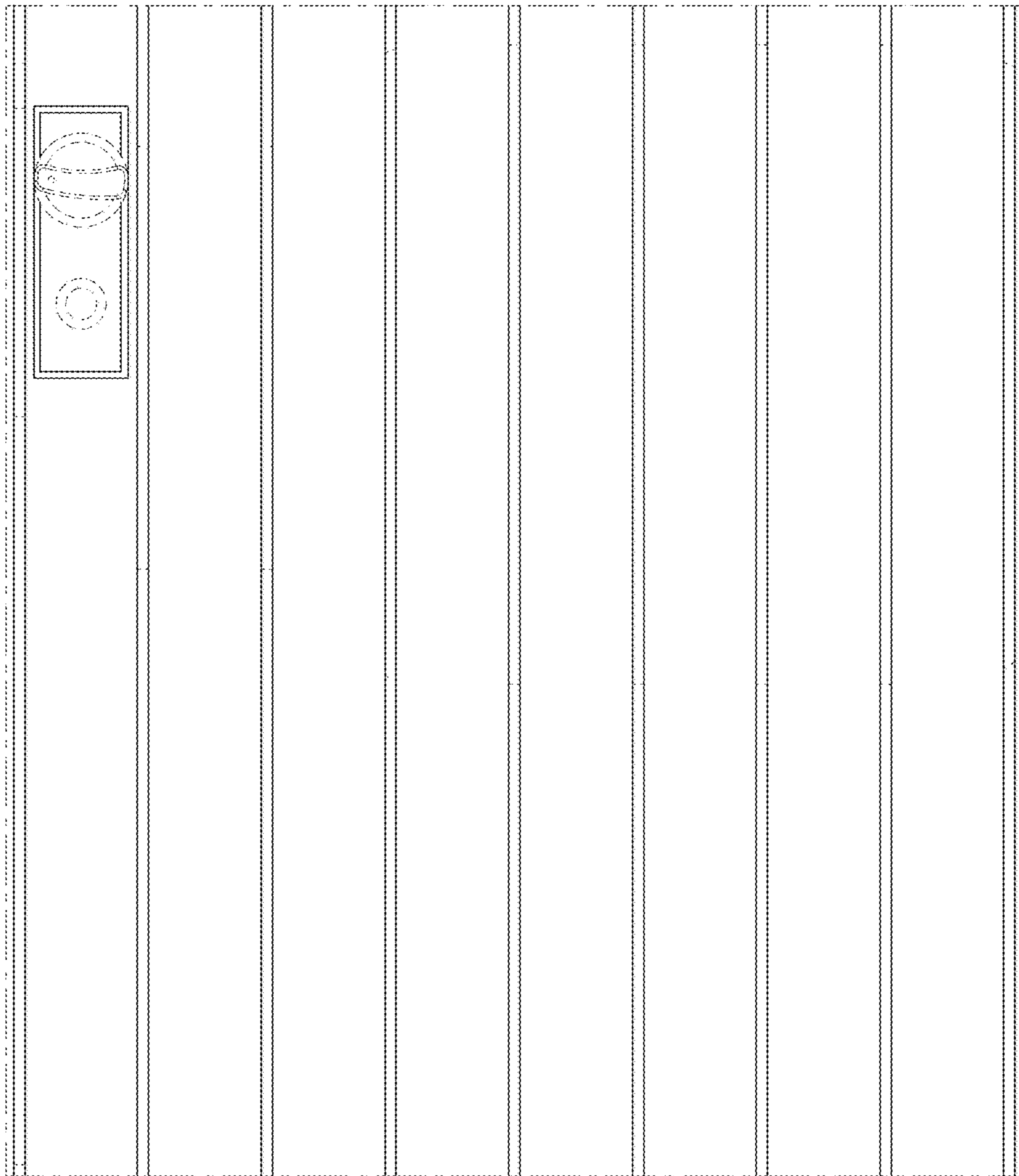

FIG. 8

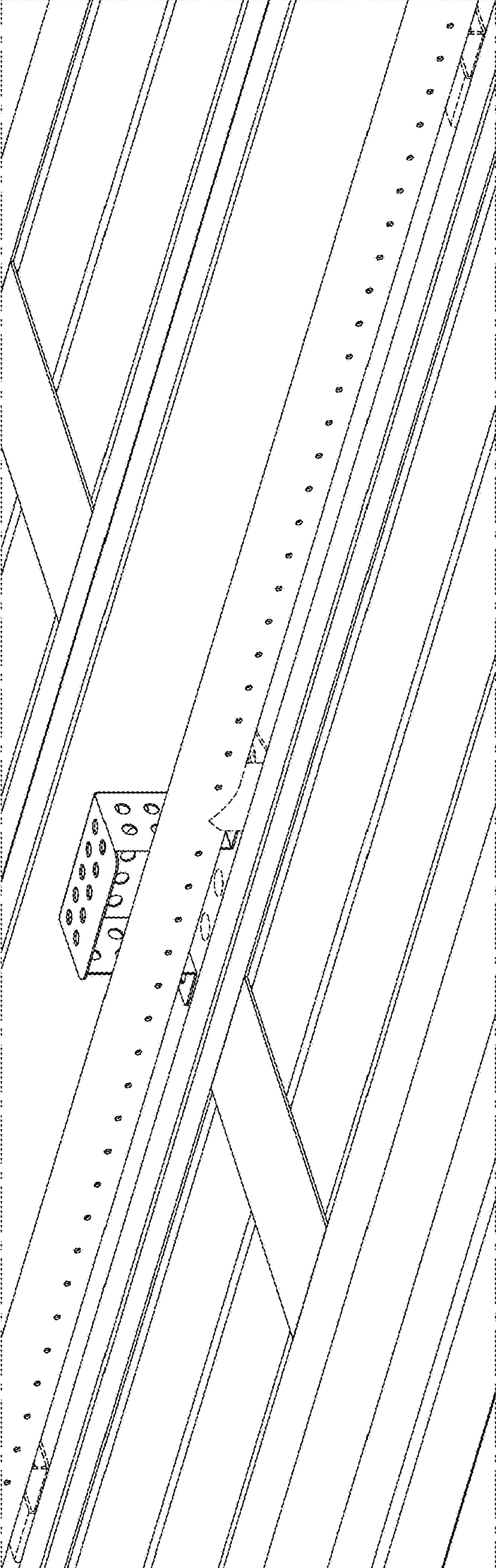

FIG. 9

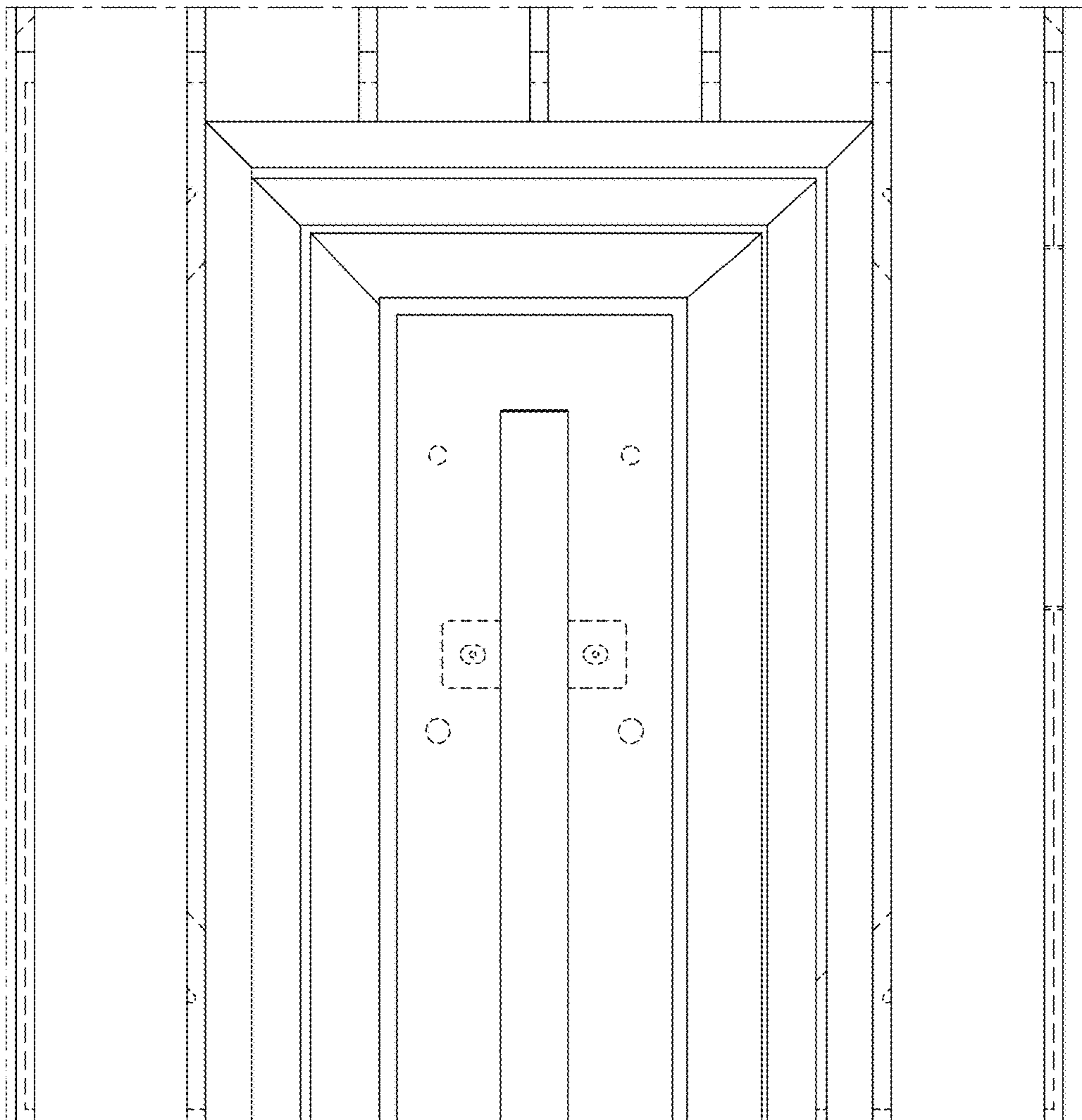

FIG. 10

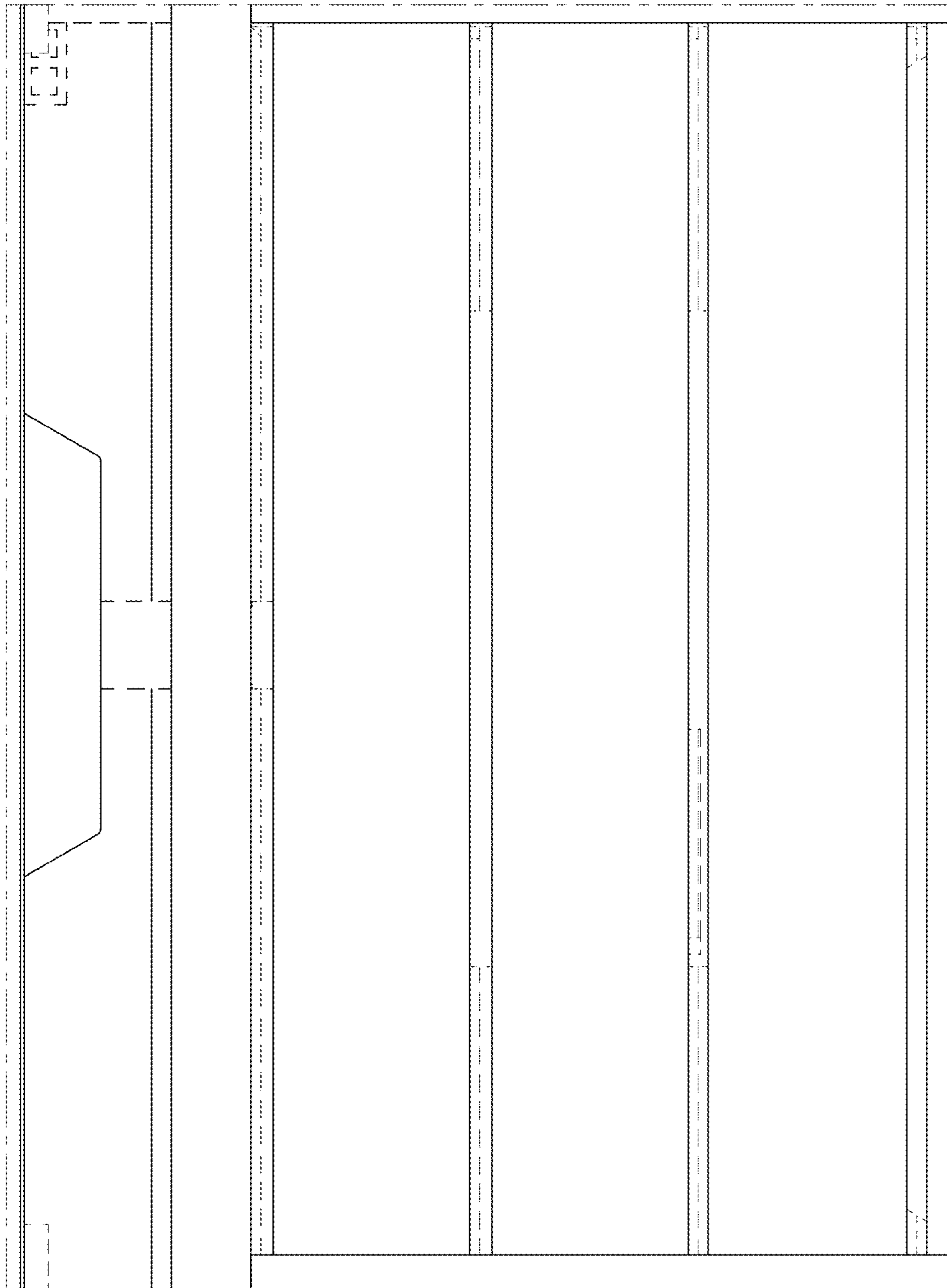

FIG. 11

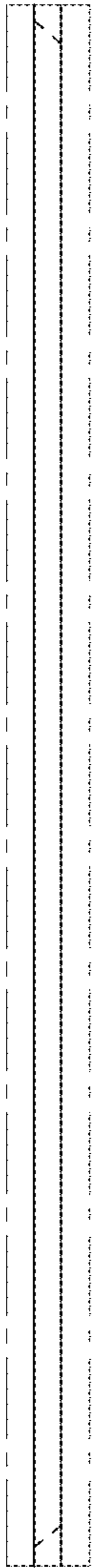

FIG. 12

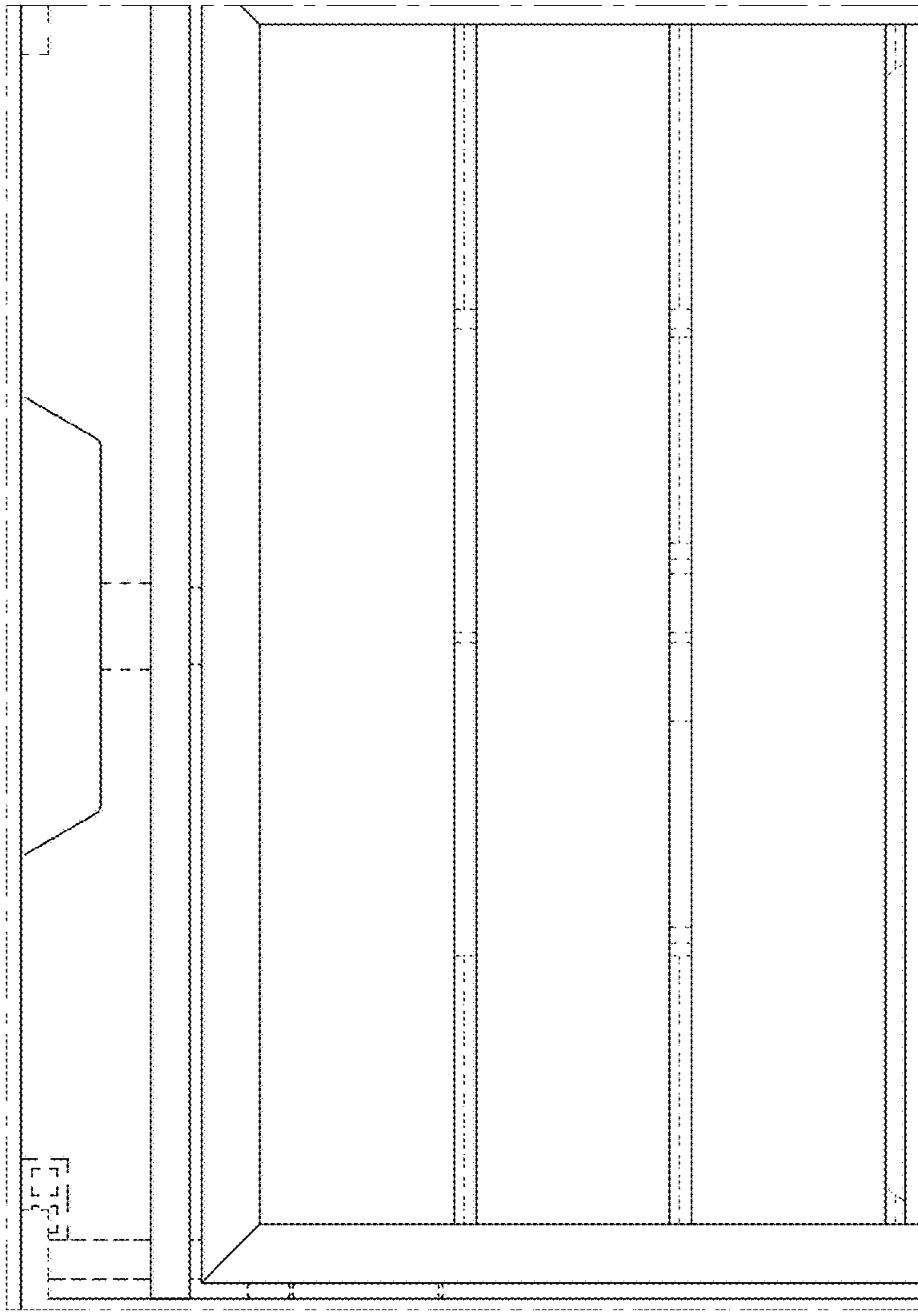

FIG. 13