



US00D857821S

(12) **United States Design Patent** (10) **Patent No.:** **US D857,821 S**  
**Marukawa et al.** (45) **Date of Patent:** **\*\* Aug. 27, 2019**

(54) **IRON CLUB HEAD**

(71) Applicant: **Taylor Made Golf Company, Inc.**,  
Carlsbad, CA (US)

(72) Inventors: **Tomotaro Marukawa**, Carlsbad, CA  
(US); **Paul M. Demkowski**, Cardiff,  
CA (US); **Thomas Thanh Vu**,  
Westminster, CA (US); **Michael**  
**Walker**, Vista, CA (US); **Allan Capili**  
**Saliba**, Fallbrook, CA (US)

(73) Assignee: **Taylor Made Golf Company, Inc.**,  
Carlsbad, CA (US)

(\*\*) Term: **15 Years**

(21) Appl. No.: **29/628,825**

(22) Filed: **Dec. 7, 2017**

(51) **LOC (12) Cl.** ..... **21-02**

(52) **U.S. Cl.**  
USPC ..... **D21/747**

(58) **Field of Classification Search**  
USPC ..... D21/747-751, 759  
CPC ..... A63B 53/00; A63B 53/02; A63B 53/04;  
A63B 53/047; A63B 53/0475; A63B  
2053/0479; A63B 2053/0483; A63B  
2053/0445; A63B 60/00; A63B 60/46  
See application file for complete search history.

(56) **References Cited**

U.S. PATENT DOCUMENTS

D435,277 S	*	12/2000	Erickson	.....	D21/747
D436,149 S	*	1/2001	Helmstetter	.....	D21/748
D454,606 S	*	3/2002	Helmstetter	.....	D21/747
D475,108 S	*	5/2003	Madore	.....	D21/759
D499,155 S	*	11/2004	Imamoto	.....	D21/747
D511,553 S	*	11/2005	Madore	.....	D21/759

D512,474 S	*	12/2005	Madore	.....	D21/759
D512,475 S	*	12/2005	Madore	.....	D21/759
D516,152 S	*	2/2006	Madore	.....	D21/759
D516,649 S	*	3/2006	Imamoto	.....	D21/747
D518,538 S	*	4/2006	Ines	.....	D21/747
D534,595 S	*	1/2007	Hasebe	.....	D21/747
8,535,177 B1	*	9/2013	Wahl	.....	A63B 60/00 473/350
D736,872 S	*	8/2015	Llewellyn	.....	D21/759
D736,873 S	*	8/2015	Voshall	.....	D21/759
D827,744 S	*	9/2018	Wang	.....	D21/747
D835,734 S	*	12/2018	Milleman	.....	D21/747

\* cited by examiner

*Primary Examiner* — Mitchell I. Siegel

(74) *Attorney, Agent, or Firm* — Klarquist Sparkman LLP

(57) **CLAIM**

We claim the ornamental design for a iron club head, as shown and described.

**DESCRIPTION**

FIG. 1 is a front elevation view of a iron club head, according to one embodiment.

FIG. 2 is a rear elevation view of the iron club head of FIG. 1.

FIG. 3 is a side elevation view of a toe side of the iron club head of FIG. 1.

FIG. 4 is a side elevation view of a heel side of the iron club head of FIG. 1.

FIG. 5 is a top plan view of the iron club head of FIG. 1.

FIG. 6 is a bottom plan view of the iron club head of FIG. 1; and,

FIG. 7 is a perspective view of the iron club head of FIG. 1, as viewed from the rear and one side.

The dashed lines in the drawings are for purposes of illustrating environmental structure as well as portions of the design that form no part of the present claimed design.

**1 Claim, 4 Drawing Sheets**

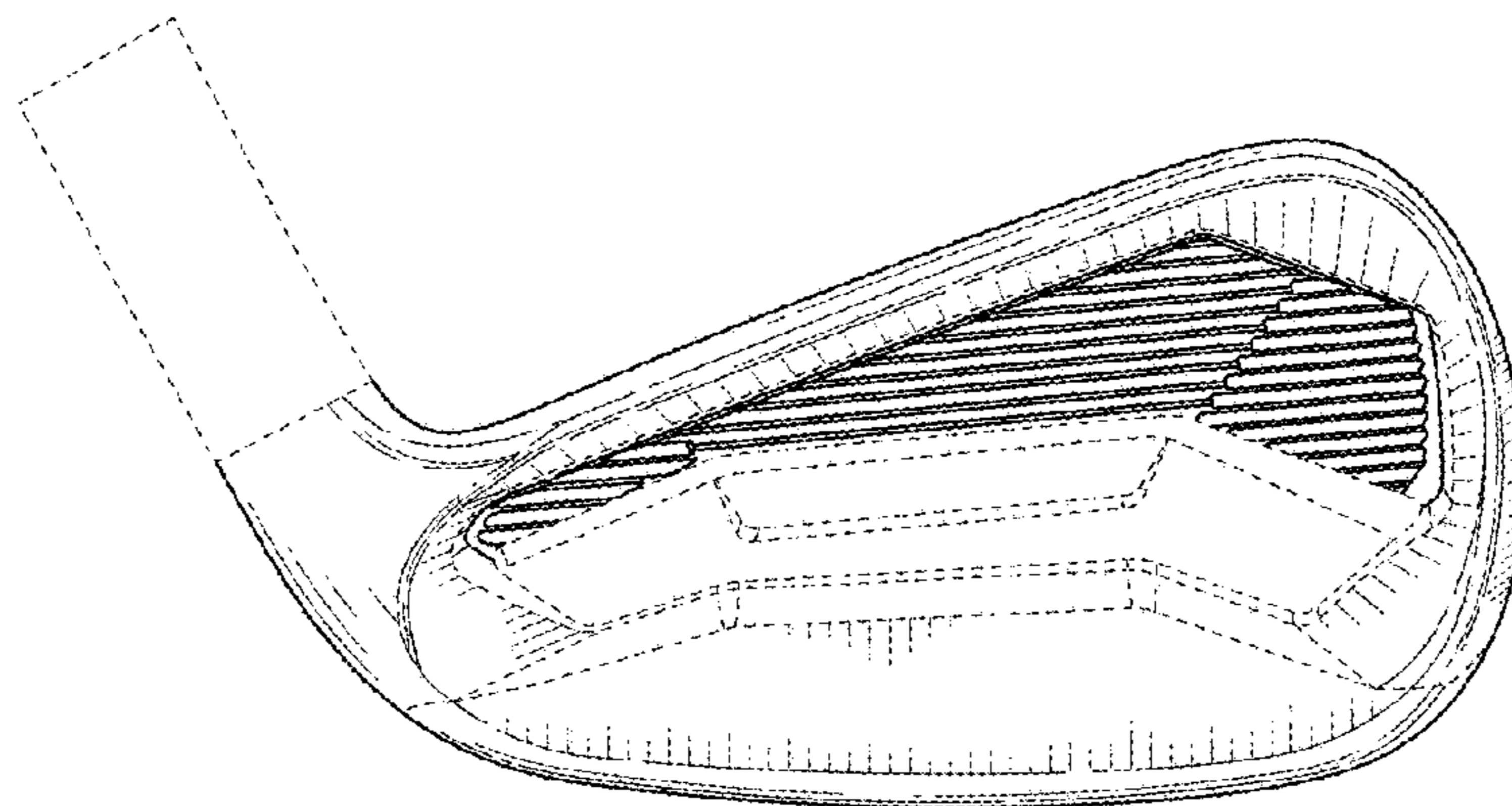

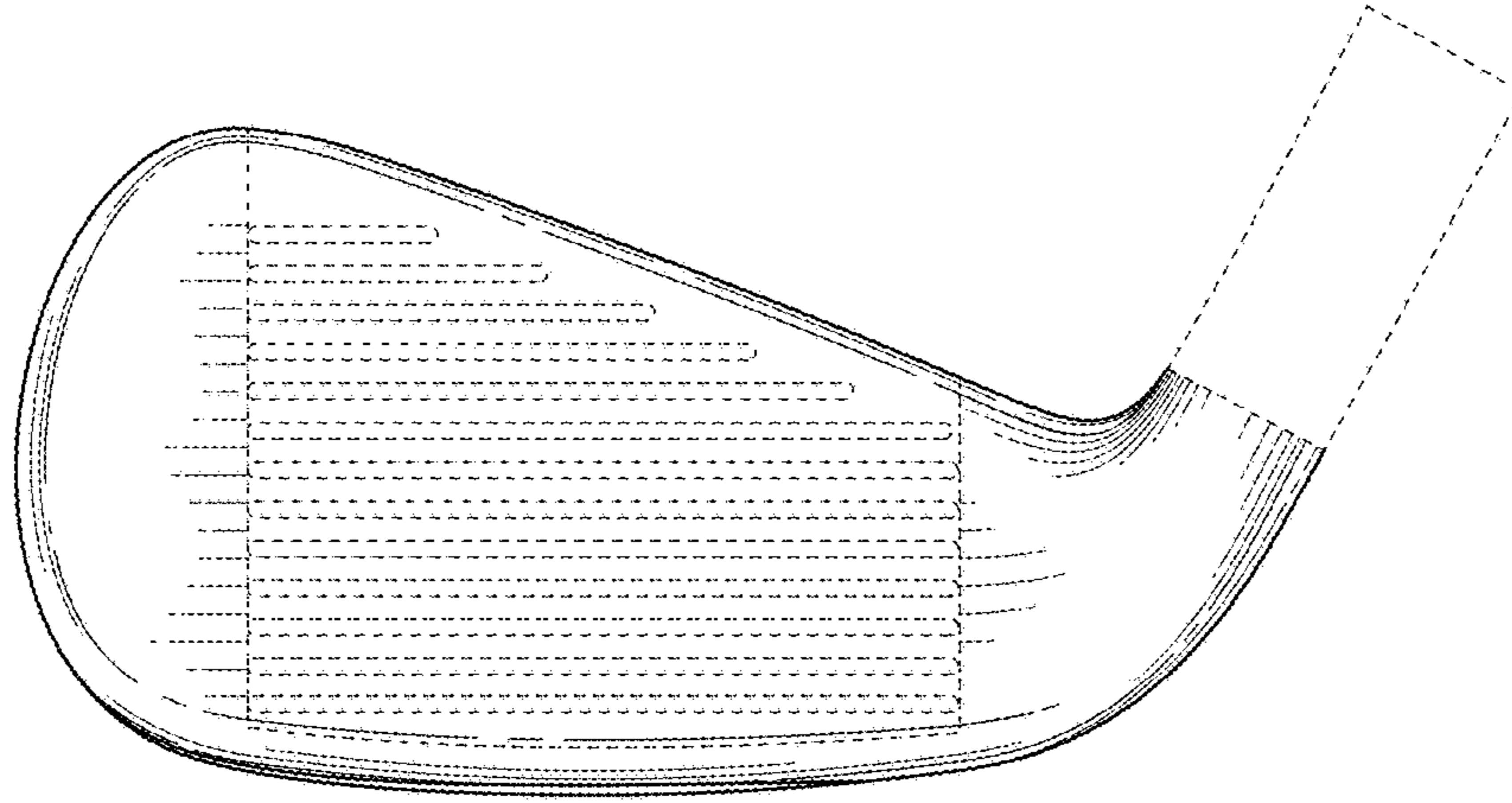

FIG. 1

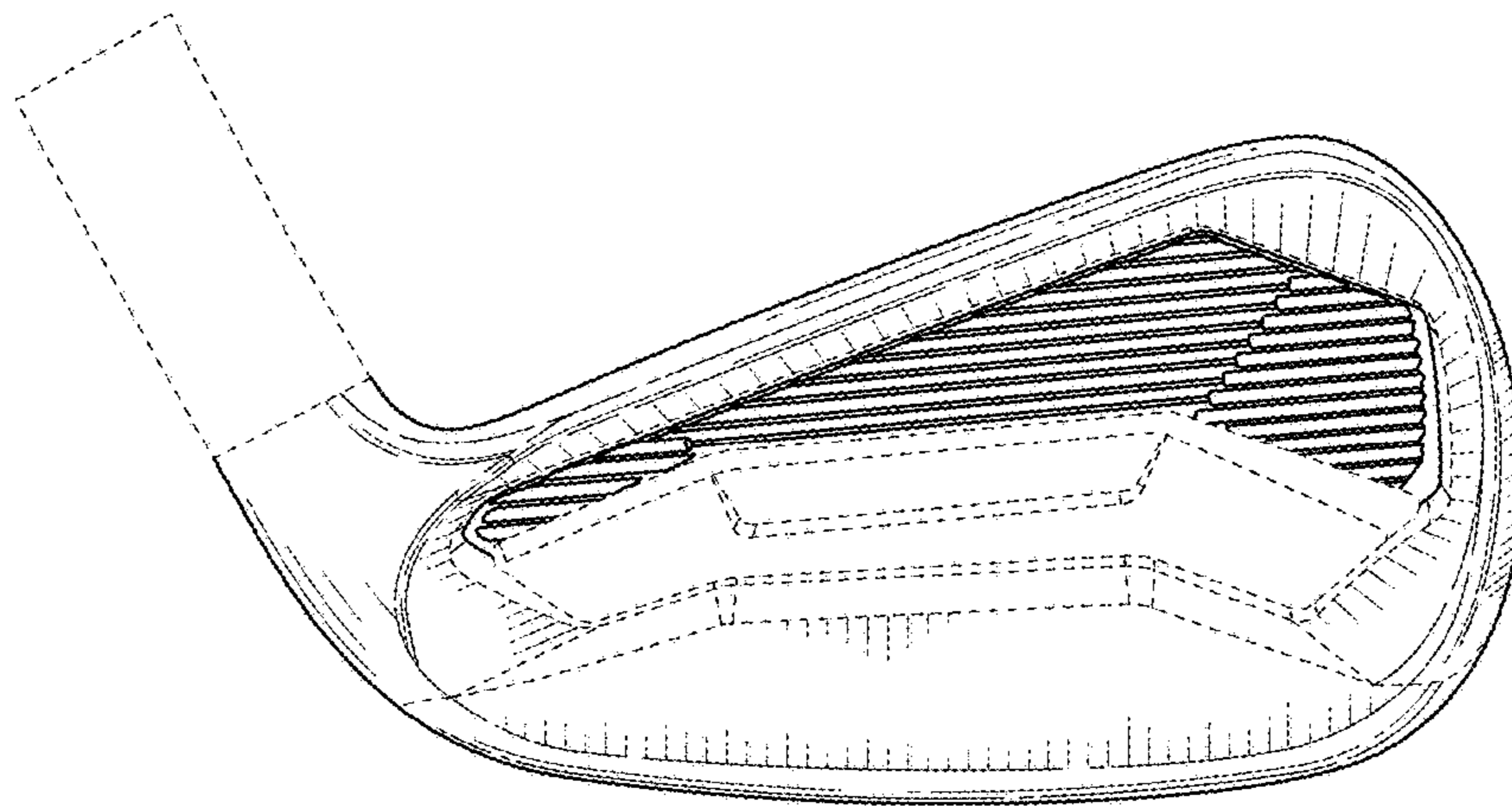

FIG. 2

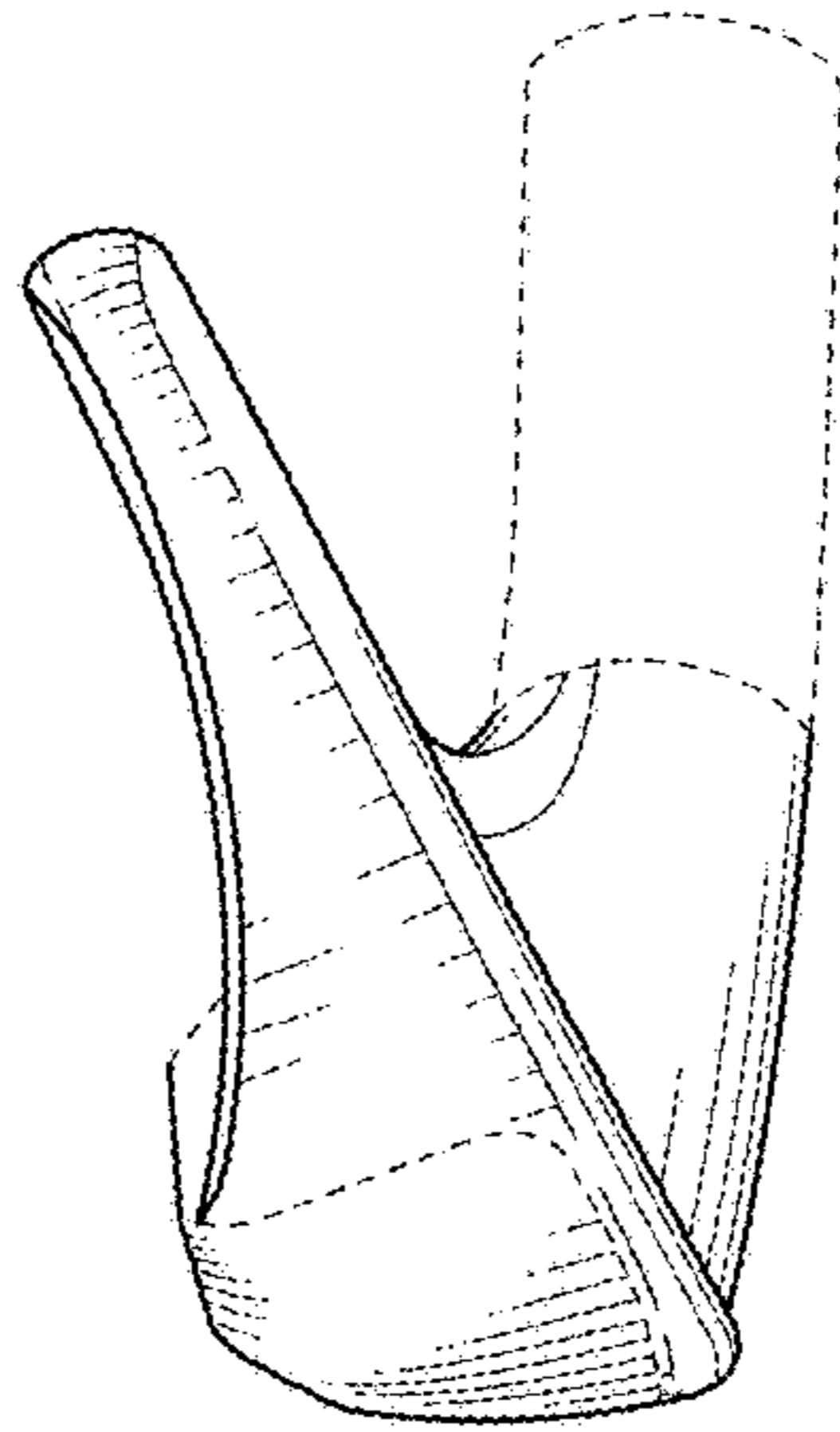

FIG. 3

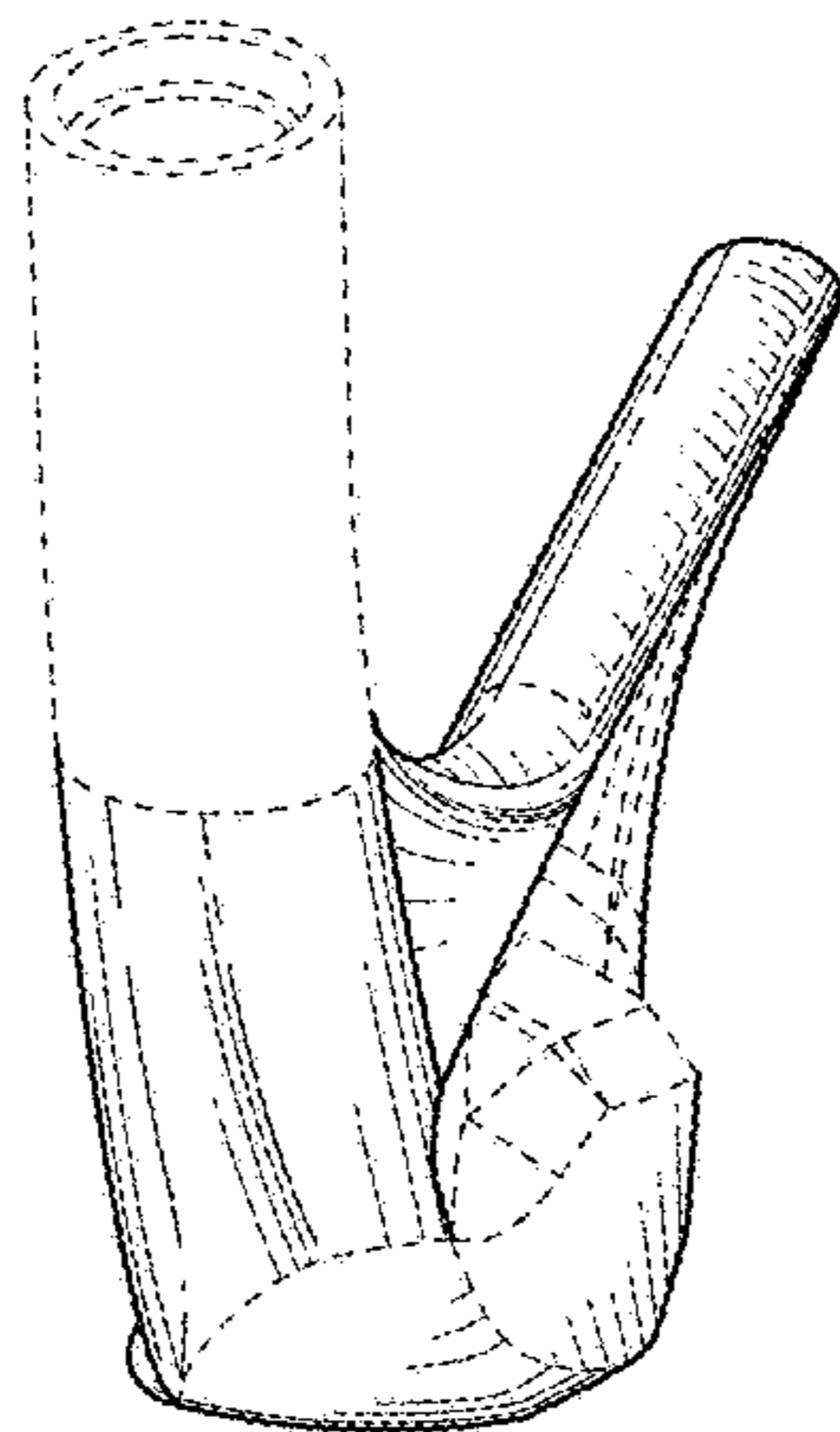

FIG. 4

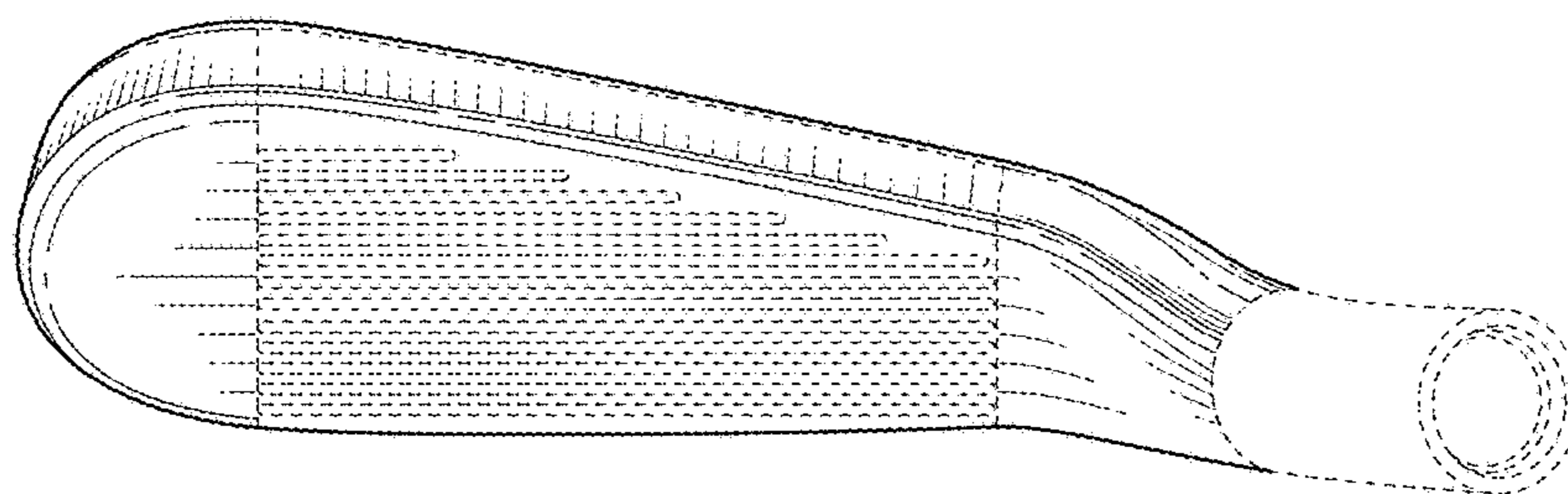

FIG. 5

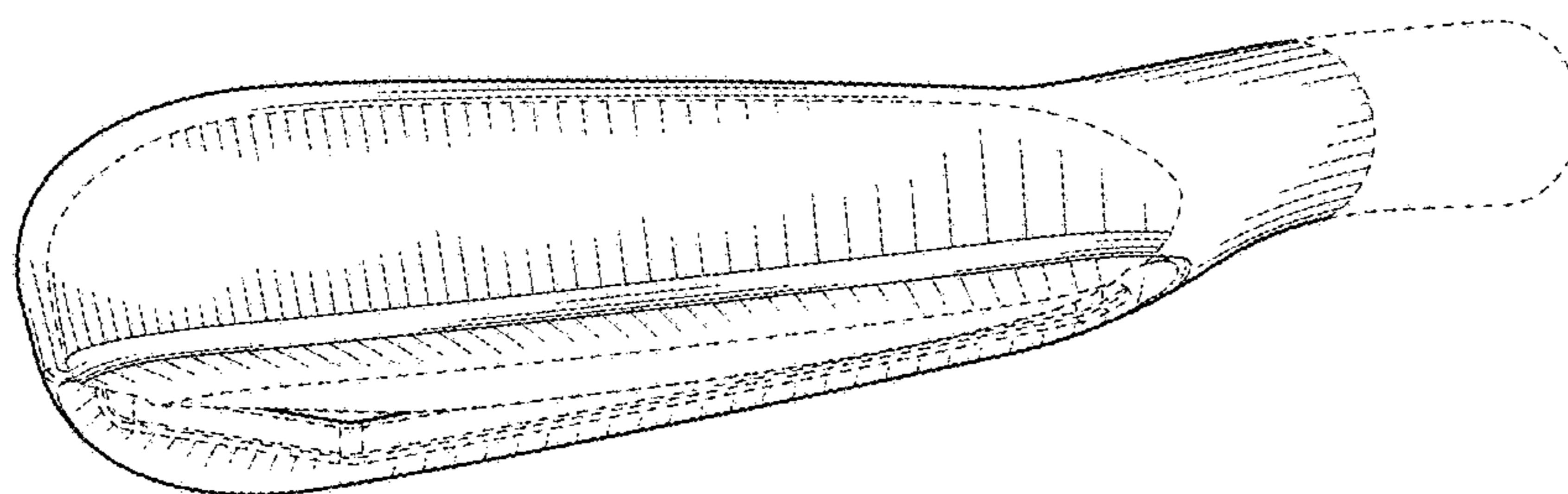

FIG. 6



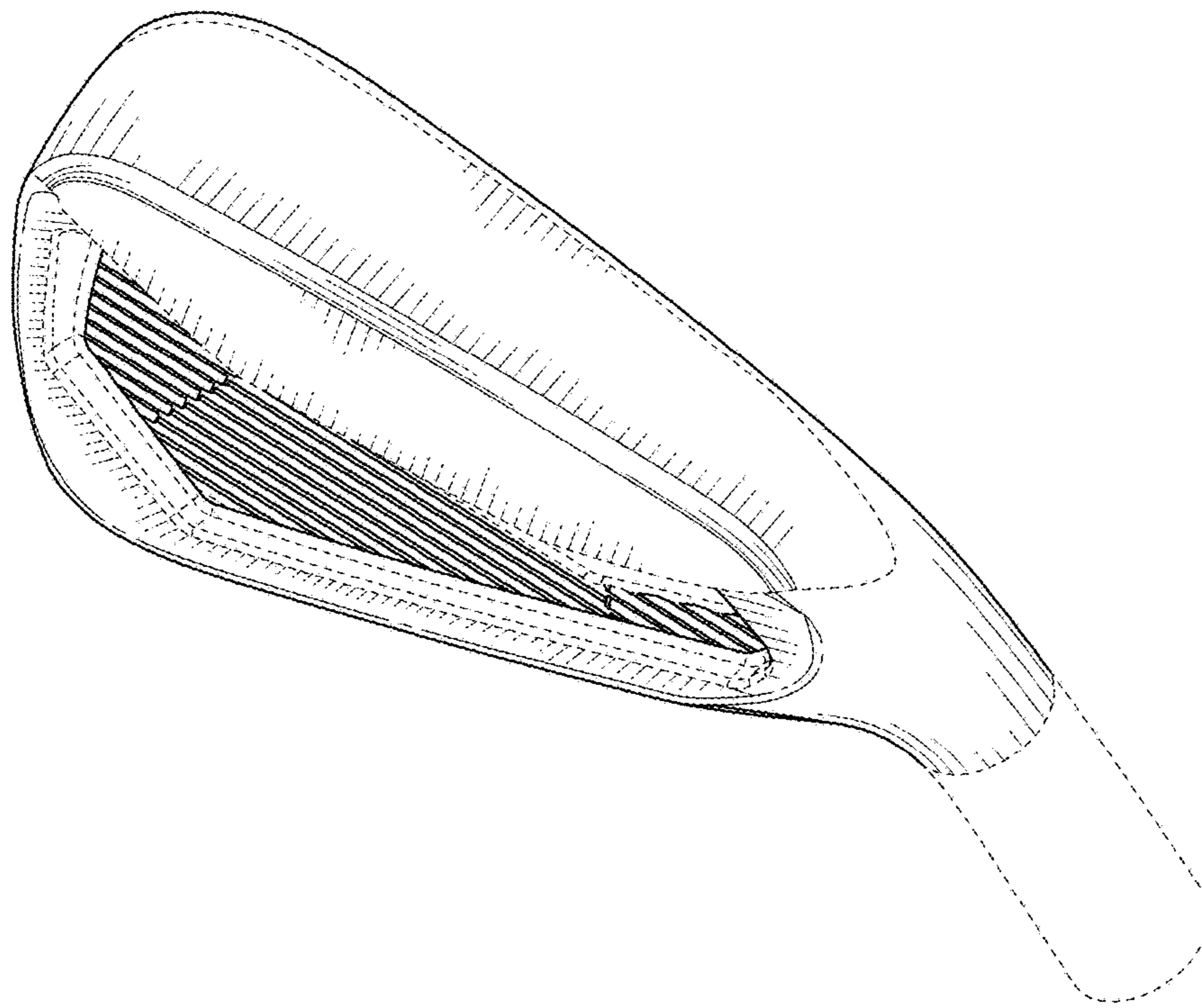

FIG. 7