



US00D857820S

(12) **United States Design Patent** (10) **Patent No.:** **US D857,820 S**
Marukawa et al. (45) **Date of Patent:** **** Aug. 27, 2019**

- (54) **IRON CLUB HEAD**
- (71) Applicant: **Taylor Made Golf Company, Inc.**,
Carlsbad, CA (US)
- (72) Inventors: **Tomotaro Marukawa**, Carlsbad, CA
(US); **Paul M. Demkowski**, Cardiff,
CA (US); **Thomas Thanh Vu**,
Westminster, CA (US); **Michael
Walker**, Vista, CA (US); **Allan Capili
Saliba**, Fallbrook, CA (US)
- (73) Assignee: **Taylor Made Golf Company, Inc.**,
Carlsbad, CA (US)
- (**) Term: **15 Years**
- (21) Appl. No.: **29/628,822**
- (22) Filed: **Dec. 7, 2017**
- (51) **LOC (12) Cl.** **21-02**
- (52) **U.S. Cl.**
USPC **D21/747**
- (58) **Field of Classification Search**
USPC D21/747–751, 759
CPC A63B 53/00; A63B 53/02; A63B 53/04;
A63B 53/047; A63B 53/0475; A63B
2053/0479; A63B 2053/0483; A63B
2053/0445; A63B 60/00; A63B 60/46
See application file for complete search history.

- (56) **References Cited**
- U.S. PATENT DOCUMENTS
- D476,048 S * 6/2003 Cleveland D21/747
D479,568 S * 9/2003 Rodgers D21/747
D517,626 S * 3/2006 Gilbert D21/747
D533,610 S * 12/2006 Cleveland D21/747

- D572,327 S * 7/2008 Diaz D21/759
D572,328 S * 7/2008 Diaz D21/759
D572,788 S * 7/2008 Diaz D21/759
D584,371 S * 1/2009 Chick D21/759
D606,607 S * 12/2009 Cooper D21/759
D659,780 S * 5/2012 Llewellyn D21/747
D682,377 S * 5/2013 Voshall D21/759
D762,793 S * 8/2016 Takechi D21/759
D802,068 S * 11/2017 Parsons D21/747
D832,953 S * 11/2018 Bacon D21/747

* cited by examiner

Primary Examiner — Mitchell I. Siegel
(74) *Attorney, Agent, or Firm* — Klarquist Sparkman LLP

(57) **CLAIM**

We claim the ornamental design for a iron club head, as shown and described.

DESCRIPTION

FIG. 1 is a front elevation view of a iron club head, according to one embodiment.
FIG. 2 is a rear elevation view of a iron club head of FIG. 1.
FIG. 3 is a side elevation view of a toe side of the iron club head of FIG. 1.
FIG. 4 is a side elevation view of a heel side of the iron club head of FIG. 1.
FIG. 5 is a top plan view of the iron club head of FIG. 1.
FIG. 6 is a bottom plan view of the iron club head of FIG. 1; and,
FIG. 7 is a perspective view of the iron club head of FIG. 1, as viewed from the rear and one side.
The dashed lines in the drawings are for purposes of illustrating environmental structure as well as portions of the design that form no part of the present claimed design.

1 Claim, 4 Drawing Sheets

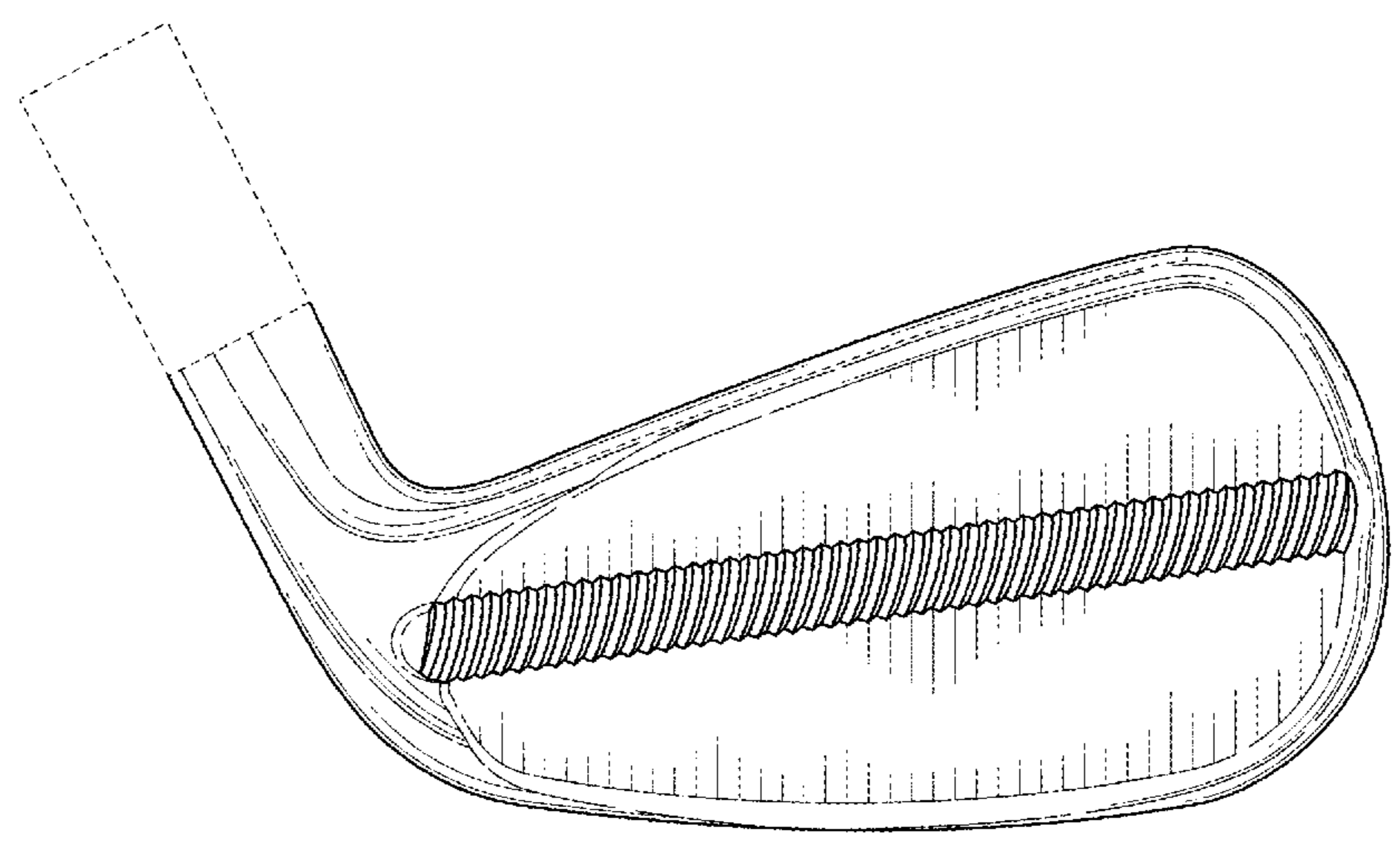

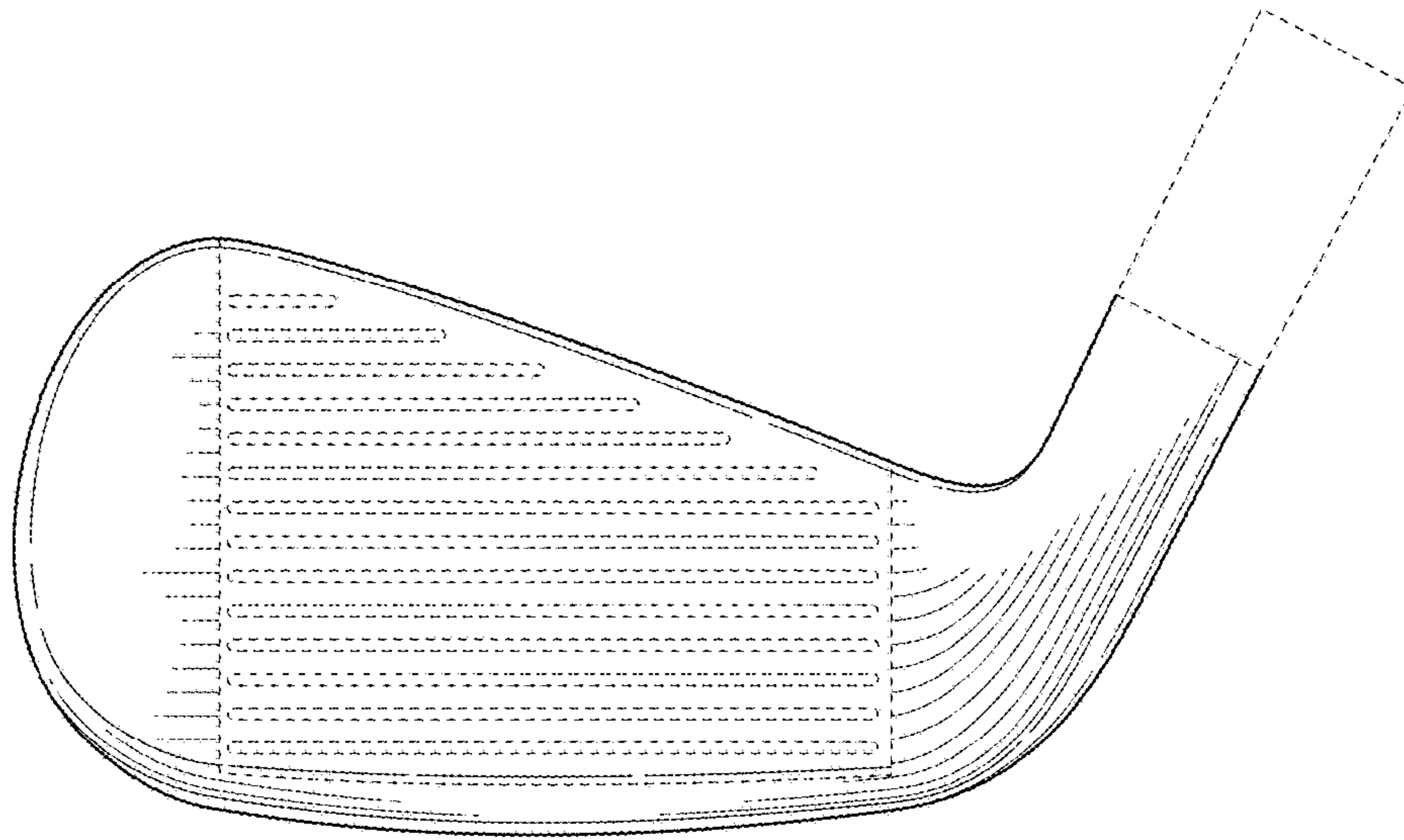

FIG. 1

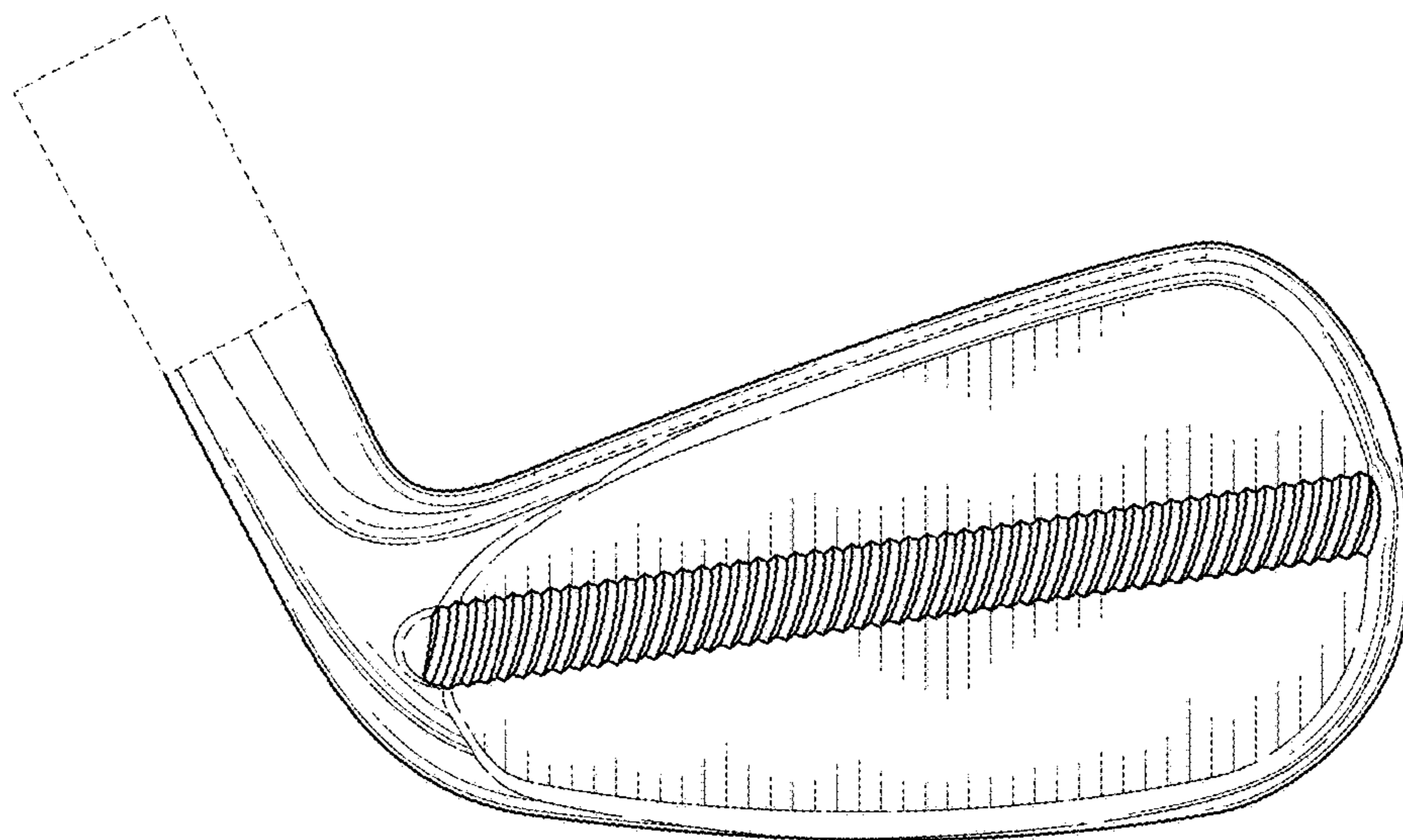

FIG. 2

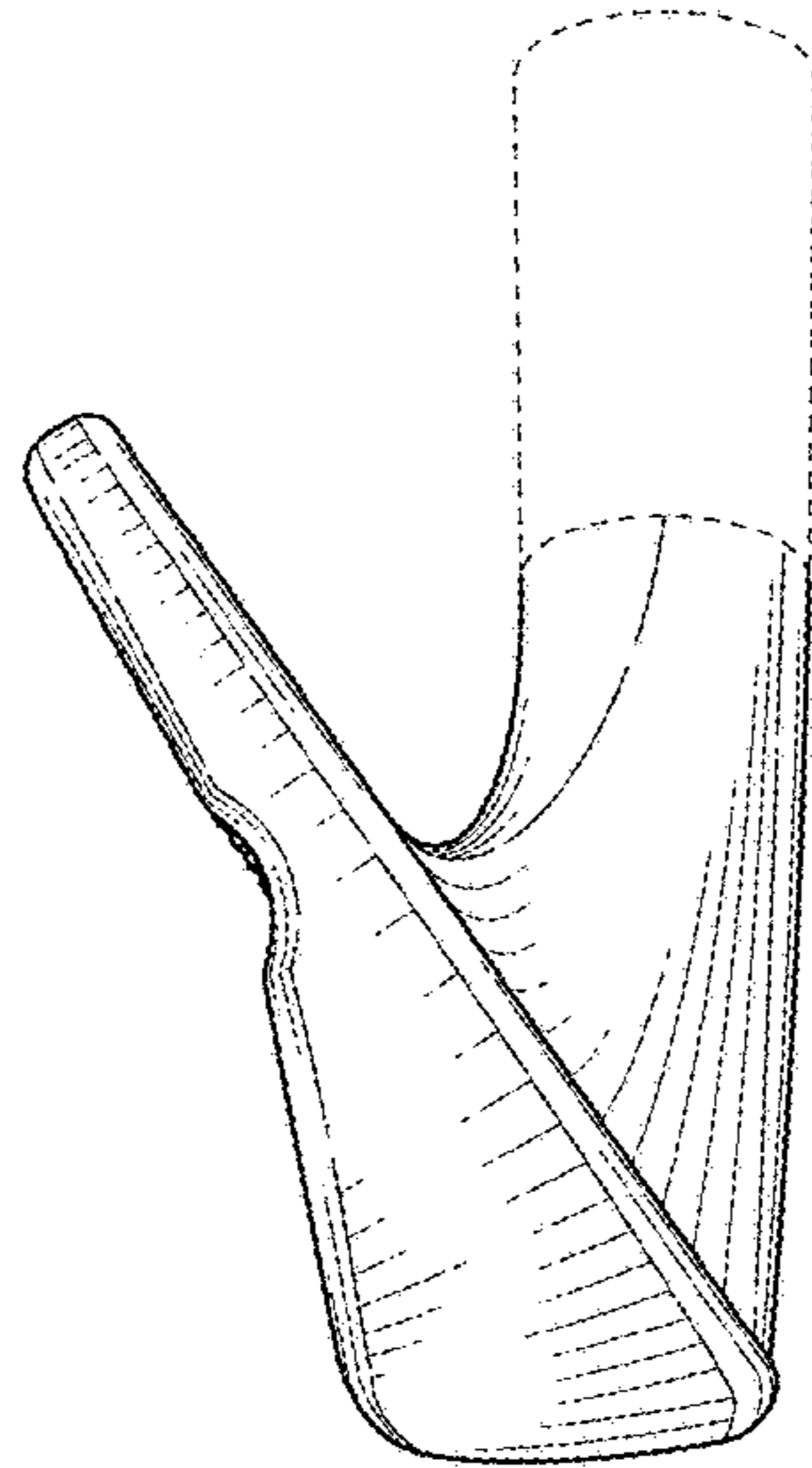

FIG. 3

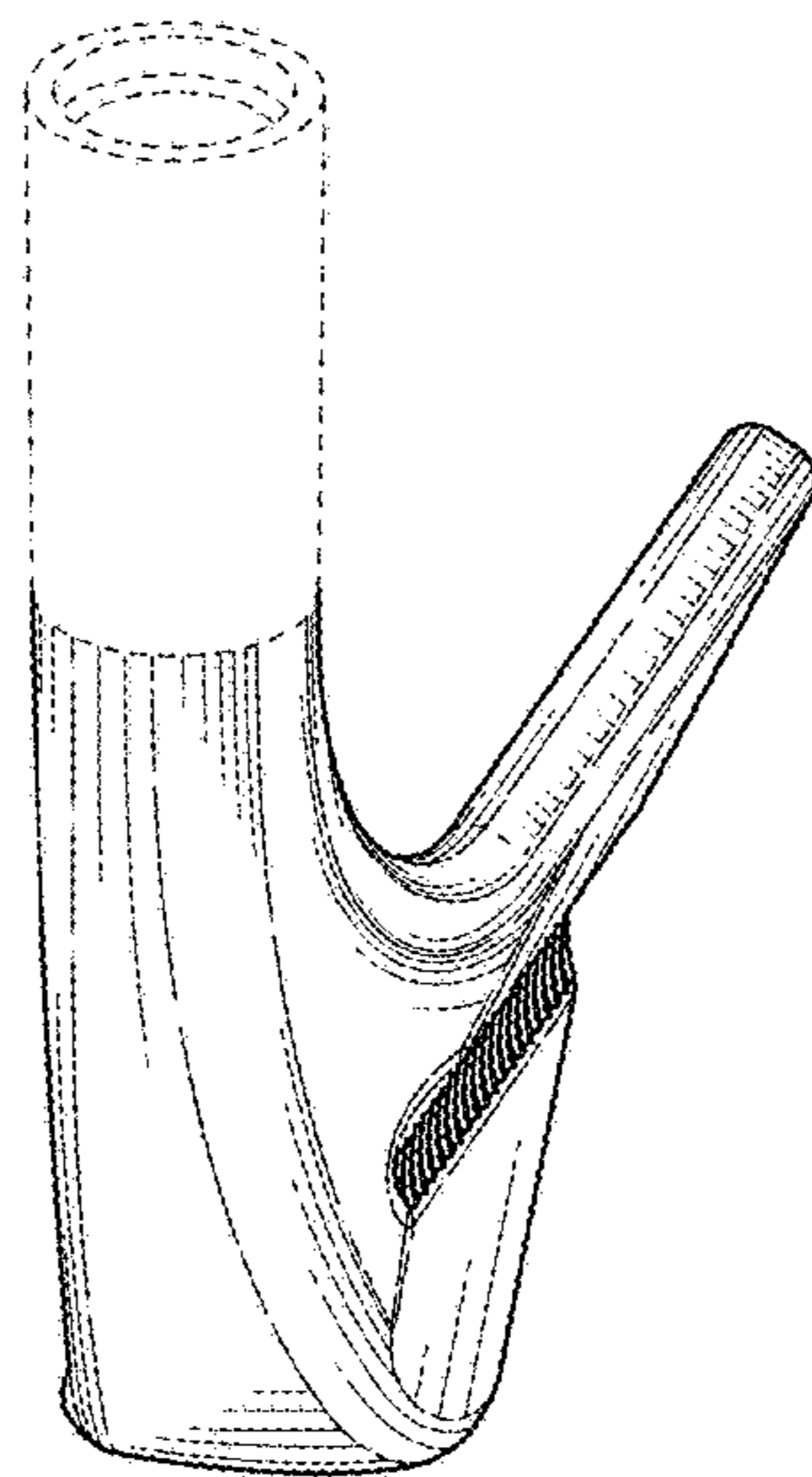

FIG. 4

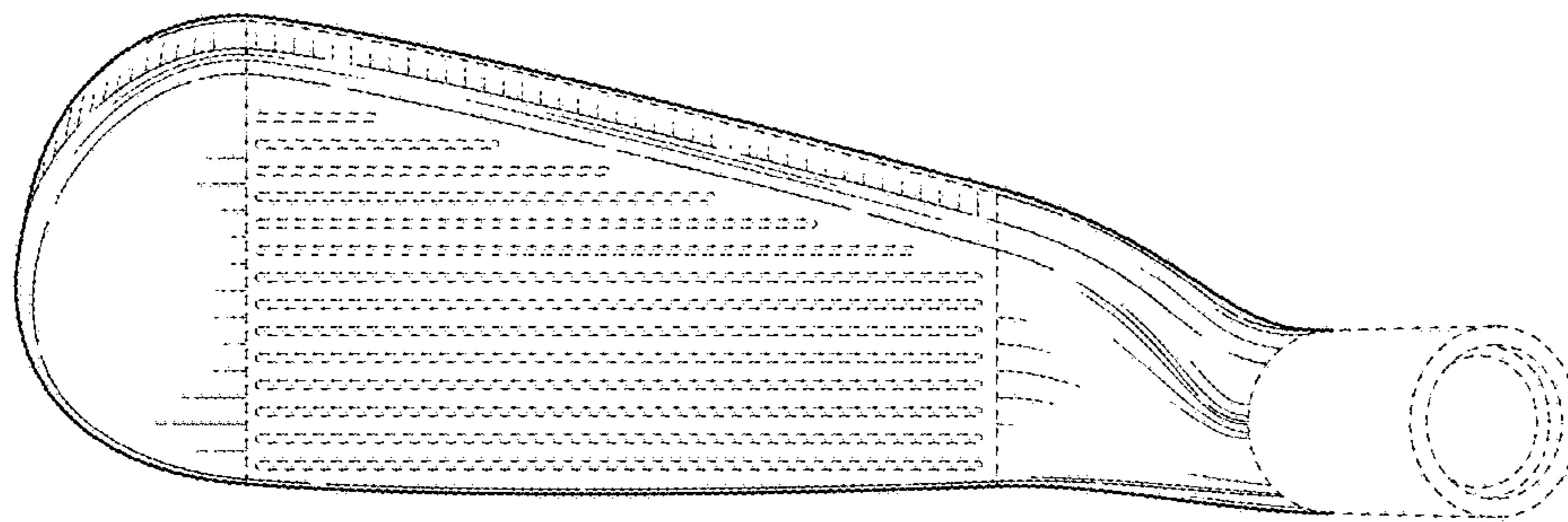

FIG. 5

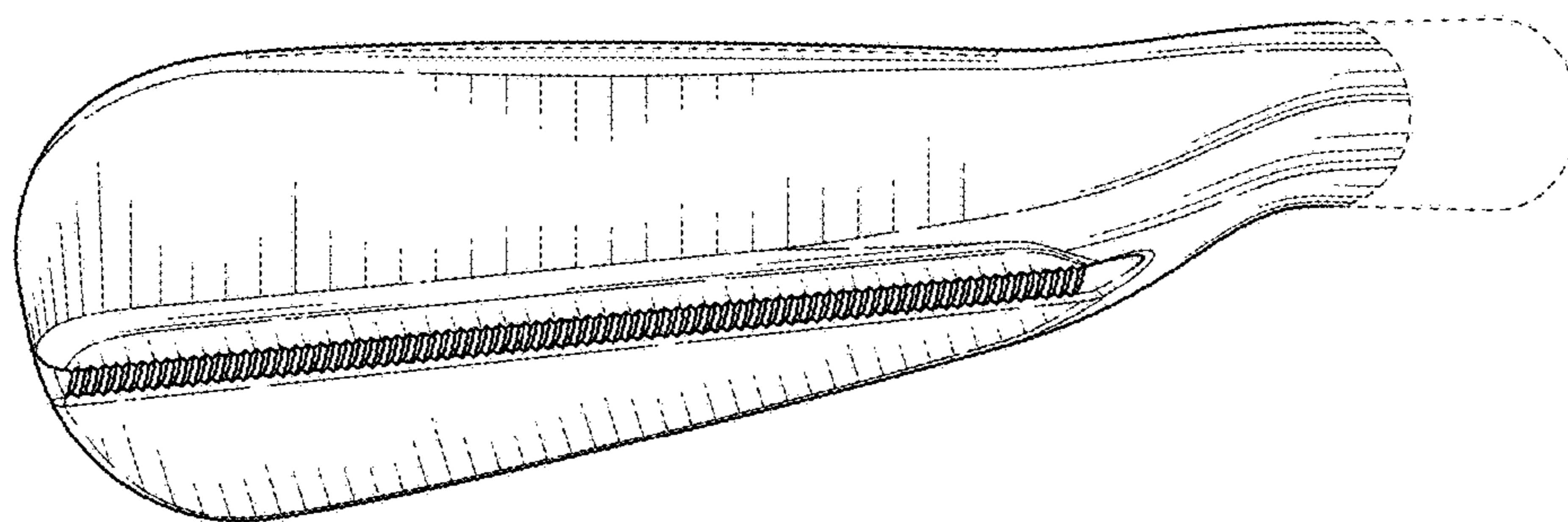

FIG. 6

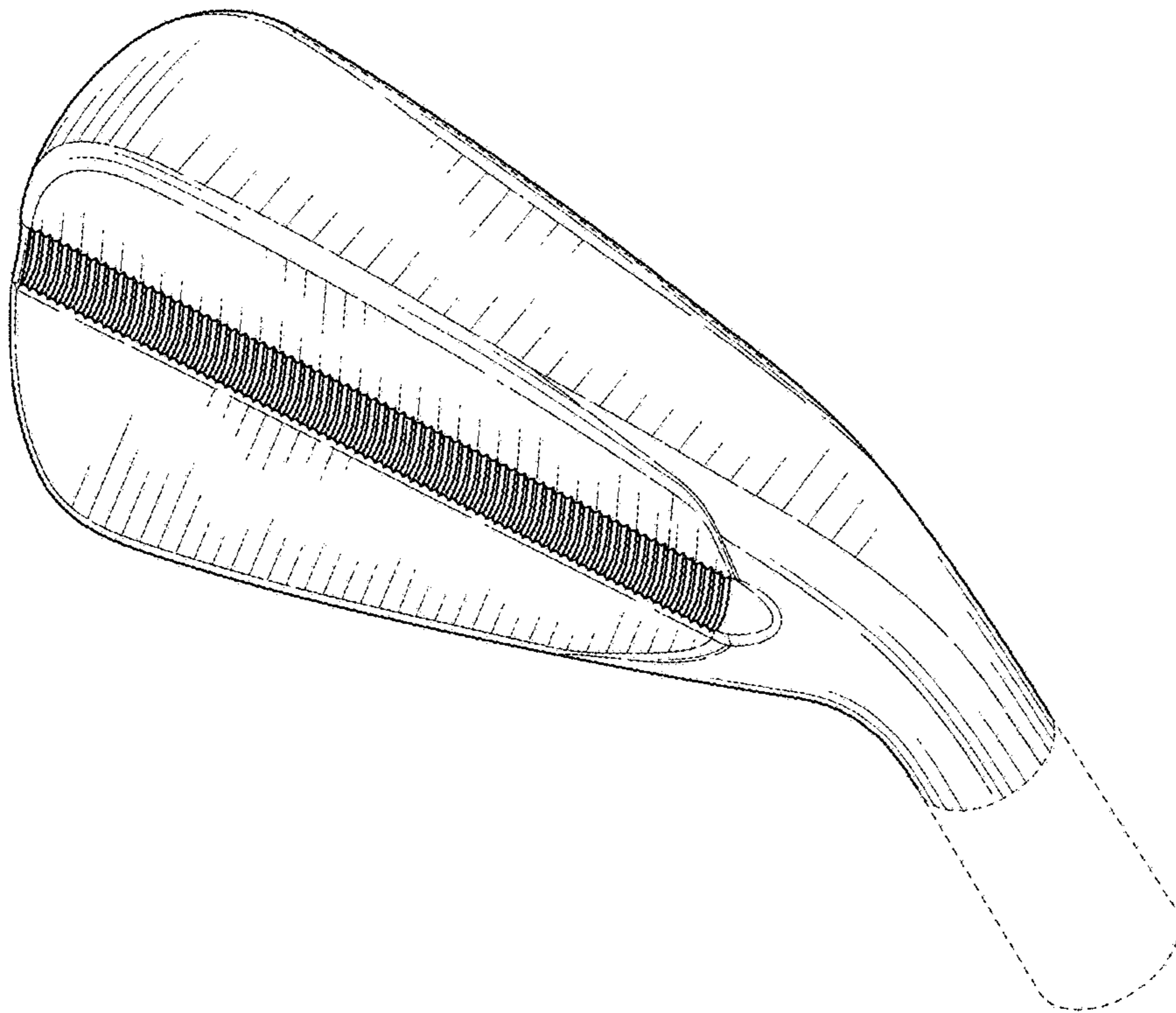

FIG. 7