



US00D857800S

(12) **United States Design Patent** (10) **Patent No.:** **US D857,800 S**
Wang (45) **Date of Patent:** **** Aug. 27, 2019**

(54) **PEN SLEEVE**
(71) Applicant: **Zhihu Wang**, Guangdong (CN)
(72) Inventor: **Zhihu Wang**, Guangdong (CN)
(**) Term: **15 Years**
(21) Appl. No.: **29/634,198**
(22) Filed: **Jan. 19, 2018**
(51) **LOC (12) Cl.** **19-06**
(52) **U.S. Cl.**
USPC **D19/204**; D19/906; D19/916
(58) **Field of Classification Search**
USPC D19/115-204; D14/411
CPC . B43K 5/005; B43K 7/12; B43K 8/04; B43K
8/06; B43K 19/00; B43K 19/02; B43K
19/14; B43K 21/006; B43K 21/06
See application file for complete search history.

5,590,971 A * 1/1997 Melnick B43K 23/122
401/202
D389,131 S * 1/1998 Nagaoka D14/431
D389,188 S * 1/1998 Conforti 401/202
5,733,448 A * 3/1998 Kaura C02F 1/003
210/238
D429,526 S * 8/2000 Sullivan D24/133
D454,368 S * 3/2002 Pellissa Beneyto D19/173
D456,040 S * 4/2002 Moon D19/169
D475,405 S * 6/2003 Cetera D19/171
D498,495 S * 11/2004 Kuo D19/201
D528,798 S * 9/2006 Molina D3/318
D579,977 S * 11/2008 Fei D19/171
D580,491 S * 11/2008 Fei D19/171
D590,879 S * 4/2009 Yu D19/168
D595,350 S * 6/2009 Paz D19/117
D809,060 S * 1/2018 Zhang D19/194
9,980,784 B2 * 5/2018 Fasolino A61B 90/39
D829,282 S * 9/2018 Keda D19/199

* cited by examiner

Primary Examiner — Elizabeth A. Albert
(74) *Attorney, Agent, or Firm* — Justin Lampel

(56) **References Cited**
U.S. PATENT DOCUMENTS

1,423,448 A * 7/1922 O'Connor 401/202
1,464,214 A * 8/1923 Ollerenshaw B43M 11/06
401/264
D112,037 S * 11/1938 Chesler D19/187
D112,582 S * 12/1938 Beck D19/187
2,613,988 A * 10/1952 Jarbeau B65D 77/283
215/388
3,424,539 A * 1/1969 Jenkins B43K 8/02
15/447
4,298,475 A * 11/1981 Gartner A47G 21/188
210/266
D289,424 S * 4/1987 Huang D10/2
5,044,512 A * 9/1991 Giancaspro A47G 19/2222
215/306
D324,824 S * 3/1992 Hansen 215/388
D327,848 S * 7/1992 Hanover 215/388
D342,088 S * 12/1993 Sonntag 401/82
D355,673 S * 2/1995 Takahashi D19/174
D364,892 S * 12/1995 Lin D19/164

(57) **CLAIM**

The ornamental design for a pen sleeve, as shown and described.

DESCRIPTION

FIG. 1 is a perspective view of a pen sleeve showing my new design;
FIG. 2 is a front side view thereof;
FIG. 3 is a rear side view thereof;
FIG. 4 is a right side view thereof;
FIG. 5 is a left side view thereof;
FIG. 6 is an enlarged bottom plan view thereof; and,
FIG. 7 is an enlarged top plan view thereof.
The broken line in FIG. 6 is included to illustrate an unclaimed part of the pen and forms no part of the claimed design.

1 Claim, 7 Drawing Sheets

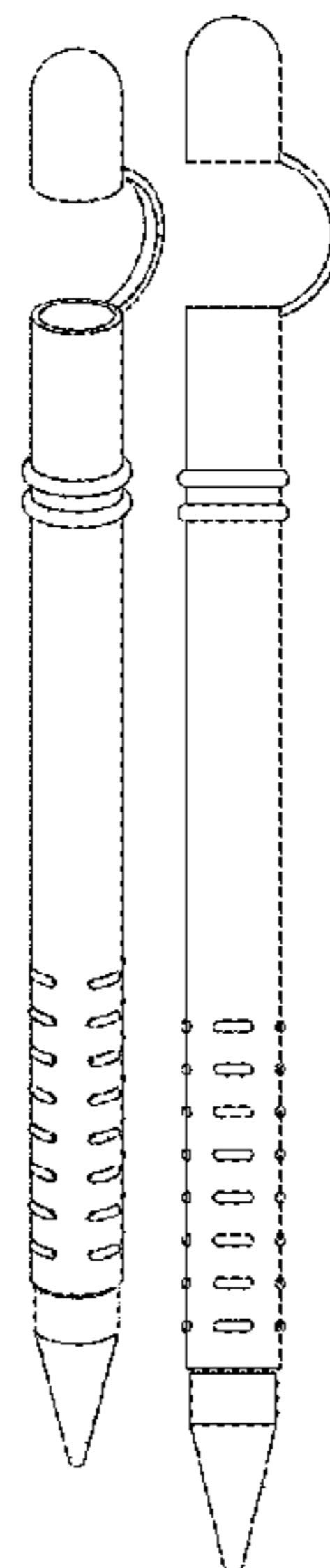

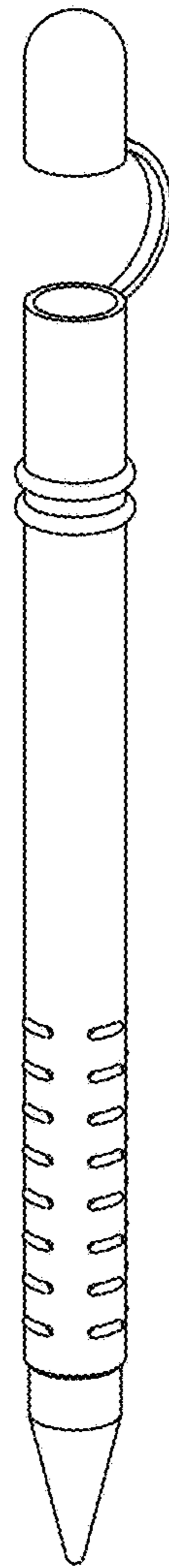

FIG. 1

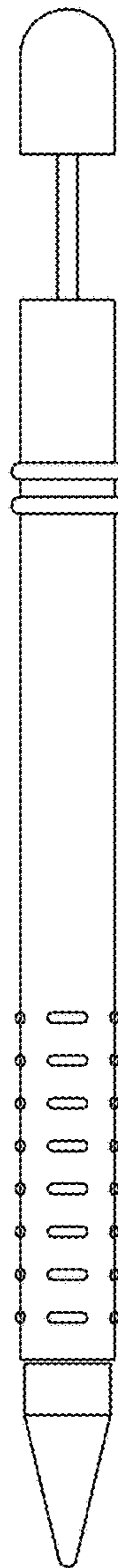

FIG. 2

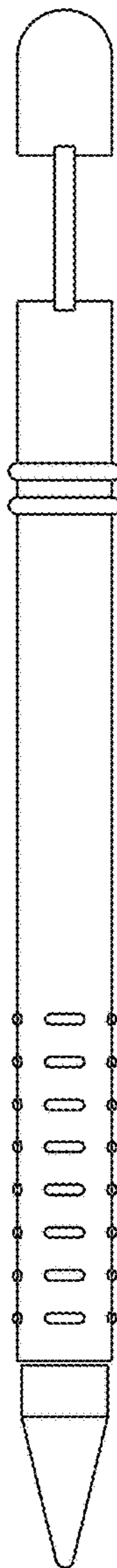

FIG. 3

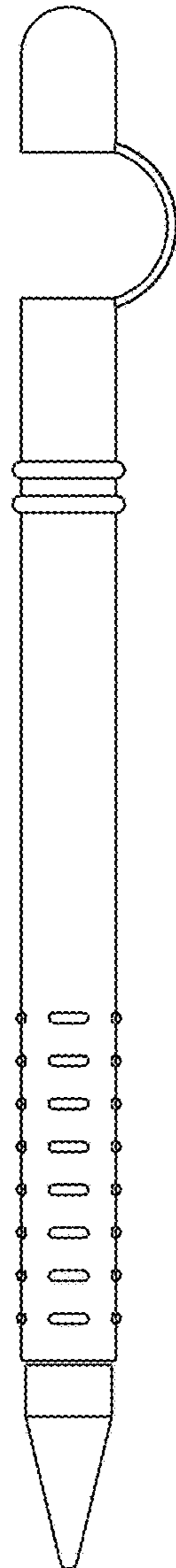

FIG. 4

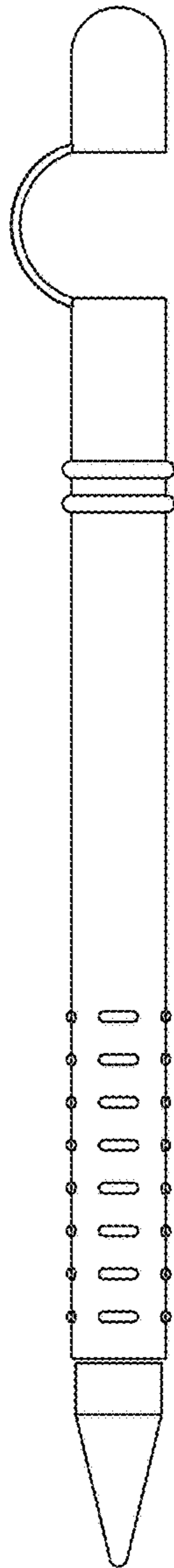

FIG. 5

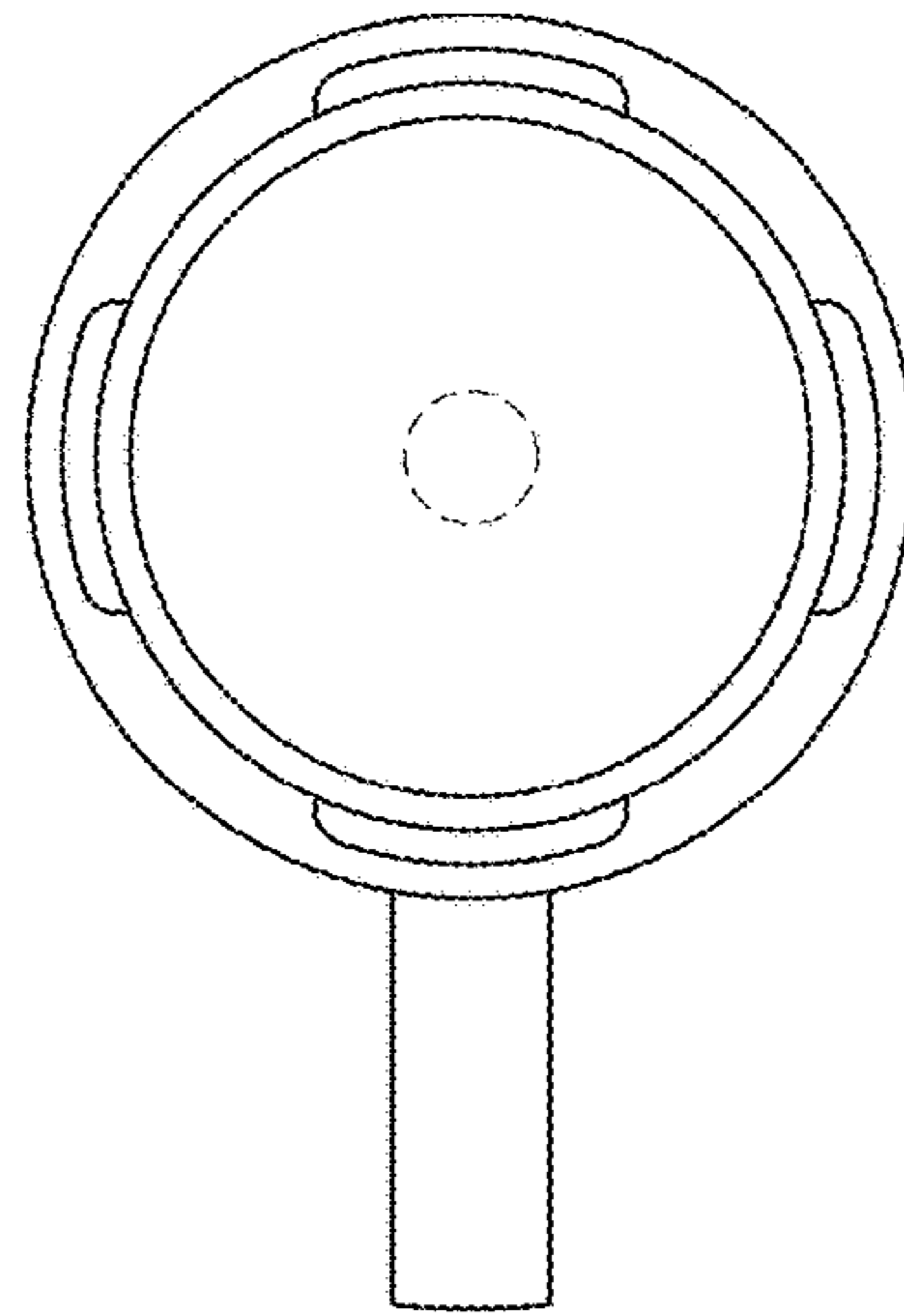

FIG. 6

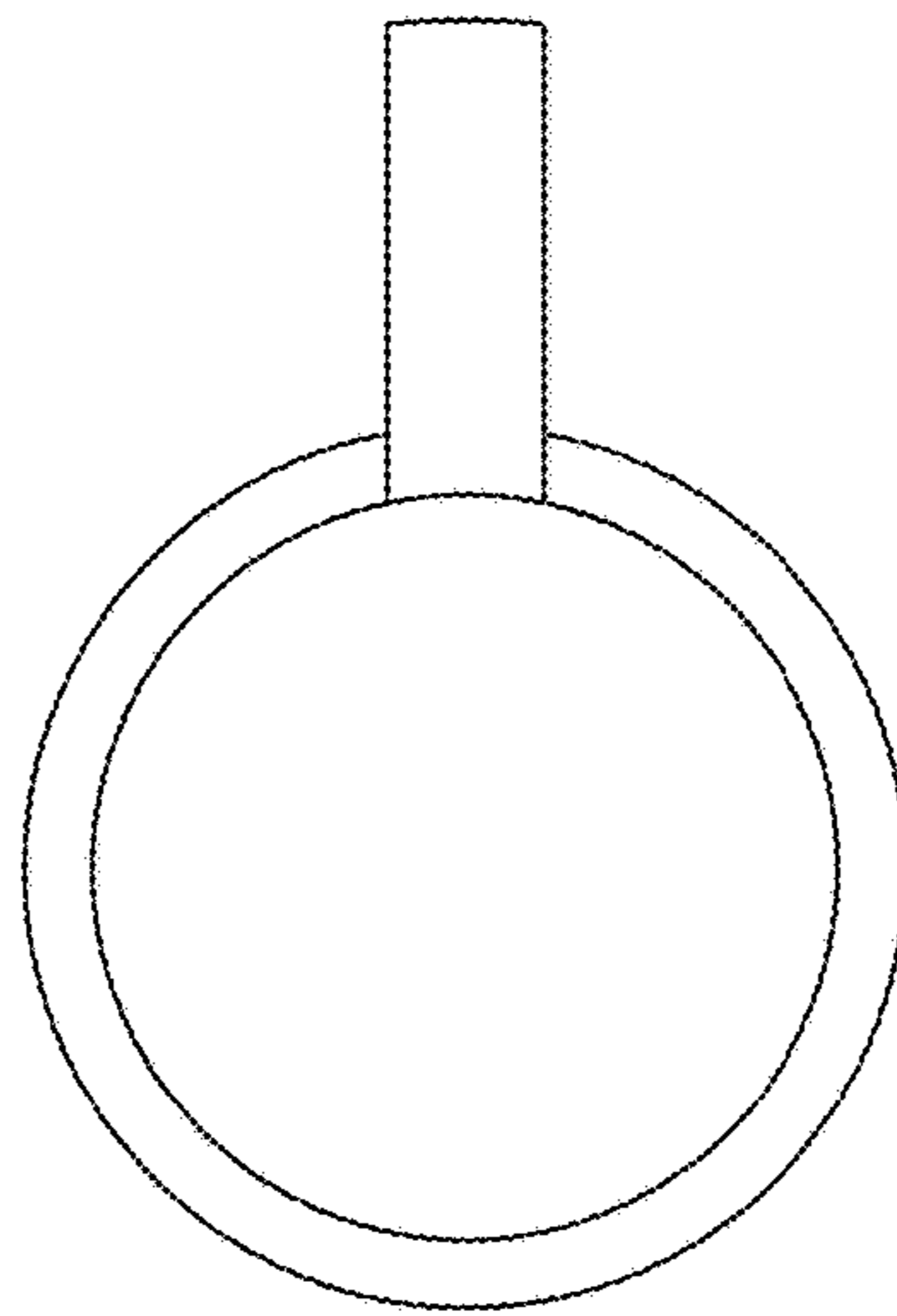

FIG. 7