



US00D857686S

(12) **United States Design Patent**
Hyun

(10) **Patent No.:** **US D857,686 S**

(45) **Date of Patent:** **** Aug. 27, 2019**

(54) **CASE FOR ELECTRONIC COMMUNICATIONS DEVICE**

(71) Applicant: **SPIGEN KOREA CO., LTD.**, Seoul (KR)

(72) Inventor: **Young Kwang Hyun**, Seoul (KR)

(73) Assignee: **SPIGEN KOREA CO., LTD.**, Seoul (KR)

(**) Term: **15 Years**

(21) Appl. No.: **29/657,383**

(22) Filed: **Jul. 20, 2018**

(51) **LOC (12) Cl.** **14-03**

(52) **U.S. Cl.**
USPC **D14/250**

(58) **Field of Classification Search**
USPC D3/201, 218, 226, 227, 247, 249, 250,
D3/269, 303; D13/103, 107, 108, 119;
D14/137, 138 R, 138 AA, 138 C, 138 G,
D14/203.3–203.7, 217, 238.1, 247, 248,
D14/250–253, 440, 447
CPC H04B 1/3888; H04M 1/0283; H04M
1/0202; A45C 1/06; A45C 2011/002;
A45C 11/00; A45F 2005/028; A45F
2200/0525

See application file for complete search history.

(56) **References Cited**

U.S. PATENT DOCUMENTS

D574,819 S	8/2008	Andre et al.
D615,077 S	5/2010	Richardson et al.
D615,536 S	5/2010	Richardson et al.
D619,361 S	7/2010	Andre
D623,639 S	9/2010	Richardson et al.
D623,640 S	9/2010	Freeman
D643,029 S	8/2011	Feng

D643,837 S	8/2011	Smith
D651,202 S	12/2011	Fathoolahi
D656,495 S	3/2012	Andre
D662,924 S	7/2012	Melanson
D662,929 S	7/2012	Fahrendorff et al.

(Continued)

OTHER PUBLICATIONS

“Spigen Ultra Hybrid Galaxy A5 Case with Air Cushion Technology and Hybrid Drop Protection for Galaxy A5—Crystal Clear”, <https://www.amazon.com/dp/B018J07DOI>, earliest review date of May 23, 2016.

(Continued)

Primary Examiner — Susan E Krakower

Assistant Examiner — L. A. Grabenstetter

(74) *Attorney, Agent, or Firm* — Heedong Chae; Lucem, PC

(57) **CLAIM**

The ornamental design for a case for electronic communications device, as shown and described.

DESCRIPTION

FIG. 1 is a front perspective view of a case for electronic communications device showing my new design; FIG. 2 is a rear perspective view thereof; FIG. 3 is a front elevational view thereof; FIG. 4 is a rear elevational view thereof; FIG. 5 is a left side elevational view thereof; FIG. 6 is a right side elevational view thereof; FIG. 7 is a top plan view thereof; FIG. 8 is a bottom plan view thereof; and, FIG. 9 is a rear perspective view thereof showing the support leg in an extended position.

The broken lines throughout the drawing figures depict portions of the case that form no part of the claimed design. The broken lines and regions bounded by broken lines form no part of the claimed design.

1 Claim, 9 Drawing Sheets

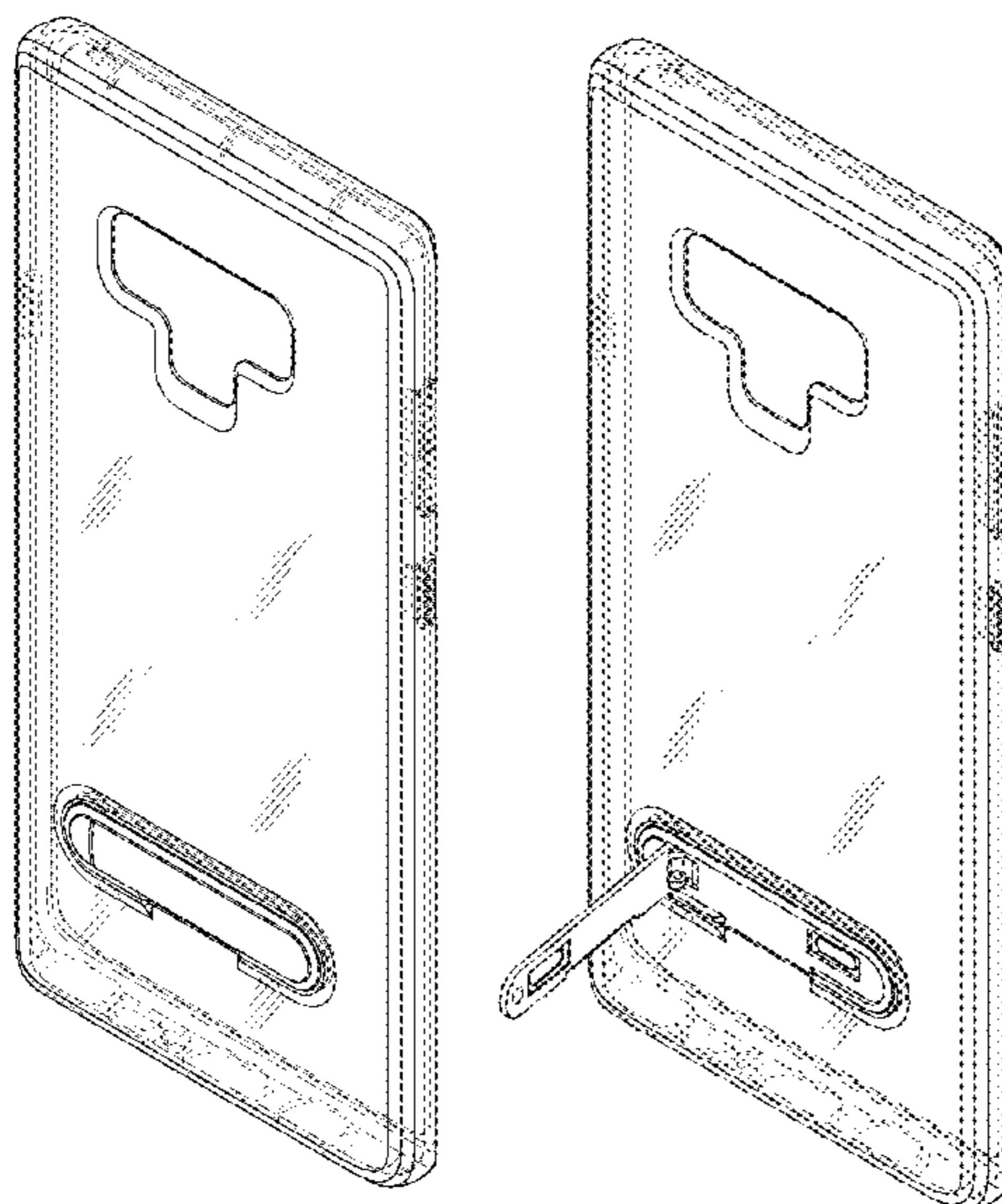

(56)

References Cited

U.S. PATENT DOCUMENTS

D663,263 S 7/2012 Gupta
 D671,930 S 12/2012 Akana et al.
 D673,539 S 1/2013 Magness et al.
 D674,789 S 1/2013 Wen
 D679,271 S 4/2013 Liu
 D679,695 S 4/2013 Fahrenedorff et al.
 D680,521 S 4/2013 Fathollahi
 D685,779 S * 7/2013 Schriefer D14/250
 D685,780 S 7/2013 Murchison
 D691,124 S * 10/2013 Yang D14/250
 D691,992 S 10/2013 Murchison
 D694,224 S 11/2013 Wooseung
 D694,759 S 12/2013 Chang
 D696,238 S 12/2013 Murchison et al.
 D696,240 S 12/2013 Kim et al.
 D697,060 S * 1/2014 Yang D14/250
 D697,503 S 1/2014 Melanson
 D706,254 S 6/2014 Chang
 D706,754 S 6/2014 Goradesky
 D709,869 S 7/2014 Witter
 D710,839 S * 8/2014 Chang D14/250
 D712,388 S 9/2014 Jia
 D714,276 S 9/2014 Hu
 D714,770 S * 10/2014 Nolan D14/250
 D719,945 S 12/2014 Chiang
 D721,071 S 1/2015 Nelson et al.
 D721,360 S 1/2015 Laffon de Mazieres
 D721,693 S 1/2015 Lee et al.
 D723,531 S * 3/2015 Katzke D14/250
 D732,543 S 6/2015 Westrup et al.
 9,059,505 B1 6/2015 Asrani
 D739,394 S 9/2015 Rayner et al.
 D741,845 S 10/2015 Kim
 D744,472 S 12/2015 Lerenthal
 D746,805 S 1/2016 Kim
 D747,708 S 1/2016 Roberts
 D749,535 S 2/2016 Joung
 D749,557 S 2/2016 Feng
 D749,594 S 2/2016 Kim
 9,293,808 B1 3/2016 Roberts
 D754,652 S 4/2016 Roberts
 D756,343 S 5/2016 Wall et al.
 D756,345 S 5/2016 Roberts
 D756,909 S 5/2016 Gupta et al.
 D756,910 S 5/2016 Gupta et al.
 D756,911 S 5/2016 Gupta et al.
 D763,239 S 8/2016 Chan et al.
 D763,241 S 8/2016 Kim
 D763,242 S * 8/2016 Kim D14/250
 D765,627 S 9/2016 Watt
 D765,633 S 9/2016 Northrup et al.
 D765,643 S 9/2016 Witter
 D765,645 S 9/2016 Kim
 D771,027 S 11/2016 Prstojeovich
 D771,612 S 11/2016 Roberts et al.
 D771,613 S 11/2016 Poon et al.
 D772,854 S 11/2016 Igarashi
 D773,445 S 12/2016 Witter et al.
 D775,614 S * 1/2017 Kim D14/250
 D776,104 S 1/2017 Tien
 D776,647 S 1/2017 Kim
 D777,157 S 1/2017 Kim
 D777,159 S 1/2017 Lee et al.
 D780,164 S * 2/2017 Lee D14/250
 D780,165 S * 2/2017 Lee D14/250
 D780,166 S 2/2017 Lin
 D780,167 S 2/2017 Tien
 D781,835 S 3/2017 Kim et al.
 D781,836 S 3/2017 Kim et al.
 D781,837 S 3/2017 Kim et al.
 D781,838 S 3/2017 Kim et al.
 D781,839 S 3/2017 Kim et al.
 D781,840 S 3/2017 Kim et al.
 D782,453 S 3/2017 Kim et al.
 D782,454 S 3/2017 Kim et al.

D784,309 S 4/2017 Lee et al.
 D786,848 S 5/2017 Park et al.
 D786,849 S 5/2017 Park et al.
 D792,394 S 7/2017 Lee et al.
 D795,237 S 8/2017 Jung et al.
 D797,715 S 9/2017 Kim
 D798,286 S * 9/2017 Roberts D14/250
 D798,853 S 10/2017 Park et al.
 D800,105 S * 10/2017 Roberts D14/250
 D801,322 S 10/2017 Song et al.
 D806,692 S * 1/2018 Jia D14/250
 D808,376 S * 1/2018 Kim D14/250
 D808,945 S * 1/2018 Yeo D14/250
 D808,955 S 1/2018 Park et al.
 D815,082 S * 4/2018 Kim D14/250
 D818,463 S * 5/2018 Kim D14/250
 D823,290 S * 7/2018 Kim D14/250
 D823,296 S 7/2018 Kim et al.
 D829,700 S * 10/2018 Kim D14/250
 D829,702 S * 10/2018 Jung D14/250
 2015/0195938 A1 7/2015 Witter
 2015/0245522 A1 8/2015 Kang
 2015/0180526 A1 9/2015 Hidaka
 2016/0058143 A1 3/2016 Tien
 2016/0198026 A1 7/2016 Del Toro

OTHER PUBLICATIONS

“Spigen Ultra Hybrid Galaxy A7 2017 Case with Air Cushion Technology and Hybrid Drop Protection for Samsung Galaxy A7 (2017)—Crystal Clear”, <https://www.amazon.com/dp/B01N9JD0MH>, earliest review date of May 6, 2017.
 “Spigen Ultra Hybrid Galaxy Note 4 Case with Air Cushion Technology and Hybrid Drop Protection for Samsung Galaxy Note 4 2014—Gunmetal”, <https://www.amazon.com/dp/B00MAWPXVW>, earliest review date of Oct. 15, 2014.
 “Spigen Ultra Hybrid Galaxy Note 4 Case with Air Cushion Technology and Hybrid Drop Protection for Samsung Galaxy Note 4 2014—Crystal Clear”, <https://www.amazon.com/dp/B00MAWPVXM>, earliest review date of Oct. 17, 2014.
 “Spigen Ultra Hybrid Galaxy S6 Case with Air Cushion Technology and Hybrid Drop Protection for Galaxy S6 2015—Crystal Clear”, <https://www.amazon.com/dp/B00QU4PN84>, earliest review date of Feb. 6, 2015.
 “Spigen Ultra Hybrid Galaxy S6 Edge Case with Air Cushion Technology and Hybrid Drop Protection for Galaxy S6 Edge 2015—Metal Slate”, <https://www.amazon.com/dp/B00SV63NNG>, earliest review date of Mar. 30, 2015.
 “Spigen Ultra Hybrid Galaxy S6 Edge Plus Case with Air Cushion Technology and Hybrid Drop Protection for Galaxy S6 Edge Plus 2015—Mint”, <https://www.amazon.com/B010MWFRFI>, earliest review date of Aug. 18, 2015.
 “Spigen Ultra Hybrid Galaxy S7 Edge Case with Air Cushion Technology and Hybrid Drop Protection for Galaxy S7 Edge 2016—Rose Crystal”, <https://www.amazon.com/dp/B01AUR0Z1G>, earliest review date of Feb. 24, 2016.
 “Spigen Ultra Hybrid Galaxy S8 Case with Air Cushion Technology and Hybrid Drop Protection for Samsung Galaxy S8 (2017)—Crystal Clear”, <https://www.amazon.com/dp/B06XP5YQNNQ>, earliest review date of Apr. 7, 2017.
 “Spigen Ultra Hybrid Galaxy S8 Plus Case with Air Cushion Technology and Hybrid Drop Protection for Galaxy S8 Plus (2017)—Crystal Clear”, <https://www.amazon.com/dp/B06XP7S564>, earliest review date of Apr. 4, 2017.
 “Spigen Ultra Hybrid Galaxy S7 Case with Air Cushion Technology and Hybrid Drop Protection for Samsung Galaxy S7 2016—Crystal Clear”, <https://www.amazon.com/dp/B01A7ID0AG>, earliest review date of Feb. 29, 2016.
 “Spigen Ultra Hybrid S Galaxy S8 Case with Air Cushion Technology and Magnetic Metal Kickstand for Samsung Galaxy S8 (2017)—Midnight Black”, <https://www.amazon.com/dp/B06XP7JTRC>, earliest review date of Apr. 10, 2017.

(56)

References Cited

OTHER PUBLICATIONS

“Spigen Ultra Hybrid S Galaxy S8 Plus Case with Air Cushion Technology and Magnetic Metal Kickstand for Galaxy S8 Plus (2017)—Crystal Clear”, <https://www.amazon.com/dp/B06XNSZJ31>, earliest review date of Apr. 9, 2017.

Nick Guy, “Review: Griffin Reveal Case for iPhone 5”, <http://www.ilounge.com/index.php/reviews/entry/griffin-reveal-case-for-iphone-5>, Published on Oct. 16, 2012, Downloaded on Feb. 6, 2019.

“Spigen Ultra Hybrid iPhone 5S/5 Case with Air Cushion Technology and Hybrid Drop Protection for iPhone 5S/iPhone 5—Crystal Clear”, <https://www.amazon.com/dp/B00G3JCFNC>, Earliest review date of Sep. 10, 2013, Downloaded on Aug. 8, 2018.

Nick Guy, “Review: Griffin Reveal for iPhone 5c”, <http://www.ilounge.com/index.php/reviews/entry/griffin-reveal-for-iphone-5c>, Published on Oct. 10, 2013, Downloaded on Feb. 5, 2019.

“Spigen Ultra Hybrid Nexus 5 Case with Air Cushion Technology and Hybrid Drop Protection for Nexus 5—Black”, <https://www.amazon.com/dp/B00FJJ38HY>, Earliest review date of Nov. 1, 2013, Downloaded on Jan. 8, 2019.

“Spigen Ultra Hybrid iPhone 6 Case with Air Cushion Technology and Hybrid Drop Protection for iPhone 6S/iPhone 6—Crystal Clear”, <https://www.amazon.com/dp/B00JH88D1O>, Earliest review date of Jul. 10, 2014, Downloaded on Dec. 28, 2018.

“Spigen Ultra Hybrid iPhone 6S Case with Air Cushion Technology and Hybrid Drop Protection for iPhone 6S/iPhone 6—Crystal Clear”, <https://www.amazon.com/dp/B010MVJNTK>, Earliest review date of Aug. 31, 2015, Downloaded on Dec. 28, 2018.

“iPhone 6s Plus Case, Spigen [Ultra Hybrid] Air Cushion [Crystal Clear] Clear back panel + TPU bumper for iPhone 6 Plus (2014)/6s Plus (2015)—Crystal Clear (SGP11644)”, <https://www.amazon.com/dp/B010MVRC20>, Earliest review date of Sep. 15, 2015, Downloaded on Jan. 4, 2019.

“Spigen Ultra Hybrid Nexus 5X Case with Air Cushion Technology and Hybrid Drop Protection for Nexus 5X—Crystal Clear”, <https://www.amazon.com/dp/B0147JXWG8>, Earliest review date of Sep. 24, 2015, Downloaded on Jan. 8, 2019.

“Spigen Ultra Hybrid TECH iPhone 6S Plus Case with Bumper Protection for iPhone 6S Plus 2015—Crystal White”, <https://www.amazon.com/dp/B013TKNIOC>, Earliest review date of Oct. 26, 2015, Downloaded on Jan. 4, 2019.

“Spigen Ultra Hybrid iPhone SE Case with Air Cushion Technology and Hybrid Drop Protection for iPhone SE 2016—Crystal Clear”, <https://www.amazon.com/dp/B01BEDO0OS>, Earliest review date of Apr. 15, 2016, Downloaded on Jan. 4, 2019.

“Spigen Ultra Hybrid iPhone 7 Case with Air Cushion Technology and Hybrid Drop Protection for iPhone 7 2016—Black”, <https://www.amazon.com/dp/B01GIVXBVY>, Earliest review date of Sep. 1, 2016, Downloaded on Jan. 8, 2019.

“Spigen Ultra Hybrid iPhone 7 Plus Case with Air Cushion Technology and Hybrid Drop Protection for Apple iPhone 7 Plus 2016—Crystal Clear”, <https://www.amazon.com/dp/B01GIWGFMU>, Earliest review date of Sep. 6, 2016, Downloaded on Jan. 8, 2019.

“Spigen Ultra Hybrid S iPhone Seven Plus Case with Air Cushion Technology and Magnetic Metal Kickstand for Apple iPhone Seven Plus Two Thousand and Sixteen Clear Black”, <https://www.amazon.com/dp/B01LRSF986>, Earliest review date of Sep. 7, 2016, Downloaded on Jan. 8, 2019.

“Spigen Ultra Hybrid S iPhone 7 Case with Air Cushion Technology and Magnetic Metal Kickstand for iPhone 7 2016—Crystal Clear”, <https://www.amazon.com/dp/B01J9DVBWE>, Earliest review date of Sep. 13, 2016, Downloaded on Jan. 8, 2019.

“Spigen Ultra Hybrid Google Pixel XL Case with Air Cushion Technology and Hybrid Drop Protection for Google Pixel XL 2016—Crystal Clear”, <https://www.amazon.com/dp/B01M12Z4VQ>, Earliest review date of Oct. 21, 2016, Downloaded on Jan. 8, 2019.

“Spigen Ultra Hybrid [2nd Generation] iPhone 8 Plus Case/iPhone 7 Plus Case with Clear Protection and Air Cushion Technology for iPhone 8 Plus (2017)/iPhone 7 Plus (2016)—Crystal Clear”, <https://www.amazon.com/dp/B01MXKNPQ5>, Earliest review date of Jan. 9, 2017, Downloaded on Jan. 8, 2019.

“Spigen Ultra Hybrid [2nd Generation] iPhone 7 Case/iPhone 8 Case with Air Cushion Technology for Apple iPhone 7 (2016)/iPhone 8 (2017)—Crystal Clear”, <https://www.amazon.com/dp/B01M0USRWG>, Earliest review date of Jan. 17, 2017, Downloaded on Jan. 8, 2019.

Spigen Ultra Hybrid Galaxy A5 2017 Case with Air Cushion Technology and Hybrid Drop Protection for Samsung Galaxy A5 (2017)—Crystal Clear, <https://www.amazon.com/dp/B01NCJOZ1C>, Earliest review date of Mar. 2, 2017, Downloaded on Jan. 8, 2019.

“Spigen Ultra Hybrid Sony Xperia XZ Premium Case with Air Cushion Technology and Hybrid Drop Protection for Sony Xperia XZ Premium (2017)—Crystal Clear”, <https://www.amazon.com/dp/B071VZ1176>, Earliest review date of Jul. 15, 2017, Downloaded on Jan. 8, 2019.

“JETech Case for Galaxy Note 8, Shock-Absorption Soft Clear Protective Bumper Cover”, <https://www.amazon.com/dp/B0758815Z6>, Earliest review date of Oct. 12, 2017, Downloaded on Jan. 23, 2019.

“Spigen Liquid Crystal Galaxy J5 Pro (2017) Case with Slim Protection and Premium Clarity for Galaxy J5 Pro(2017) International version—Crystal Clear”, <https://www.amazon.com/dp/B072HGQ2L7>, Earliest review date of Apr. 11, 2017, Downloaded on Aug. 9, 2018.

“Spigen Liquid Crystal Galaxy Note 5 Case with Slim Protection and Premium Clarity for Galaxy Note 5 2015—Crystal Clear”, <https://www.amazon.com/dp/B010MWEUII>, Earliest review date of Aug. 22, 2015, Downloaded on Aug. 9, 2018.

“Spigen Liquid Crystal Galaxy S6 Case with Light but Durable Flexible Clear TPU Protection for Samsung Galaxy S6 (2015)—Crystal Clear”, <https://www.amazon.com/dp/B00QU4N7AK>, Earliest review date of Mar. 25, 2015, Downloaded on Aug. 9, 2018.

“Spigen Liquid Crystal Galaxy S6 Edge Case with Light but Durable Flexible Clear TPU Protection for Samsung Galaxy S6 Edge (2015)—Crystal Clear”, <https://www.amazon.com/dp/B00UCETHEO>, Earliest review date of Mar. 25, 2015, Downloaded on Aug. 9, 2018.

“Spigen Liquid Crystal Galaxy S7 Case with Slim Protection and Premium Clarity for Samsung Galaxy S7 2016—Crystal Clear”, <https://www.amazon.com/dp/B01A7ICULQ>, Earliest review date of Mar. 3, 2016, Downloaded on Aug. 9, 2018.

“Spigen Liquid Crystal Galaxy S7 Edge Case with Slim Protection and Premium Clarity for Samsung Galaxy S7 Edge 2016—Crystal Clear”, <https://www.amazon.com/dp/B01A7IDF3S>, Earliest review date of Feb. 23, 2016, Downloaded on Aug. 9, 2018.

“Spigen Liquid Crystal Galaxy S8 Case with Slim Protection and Premium Clarity for Samsung Galaxy S8 (2017)—Crystal Clear”, <https://www.amazon.com/dp/B06XP6KZKC>, Earliest review date of Apr. 5, 2017, Downloaded on Aug. 9, 2018.

“Spigen Liquid Crystal Galaxy S8 Plus Case with Slim Protection and Premium Clarity for Galaxy S8 Plus (2017)—Crystal Clear”, <https://www.amazon.com/dp/B06XP4QY2B>, Earliest review date of Apr. 1, 2017, Downloaded on Aug. 9, 2018.

“Spigen Liquid Crystal Glitter Galaxy S8 Case with Slim Protection and Premium Clarity for Samsung Galaxy S8 (2017)—Crystal Quartz”, <https://www.amazon.com/dp/B06XP5LW2G>, Earliest review date of Apr. 16, 2017, Downloaded on Aug. 9, 2018.

“Spigen Liquid Crystal Glitter Galaxy S8 Plus Case with Slim Protection and Premium Clarity for Galaxy S8 Plus (2017)—Crystal Quartz”, <https://www.amazon.com/dp/B06XP53YD6>, Earliest review date of Apr. 6, 2017, Downloaded on Aug. 9, 2018.

“Galaxy S8 Plus Case, Trianium [Clarium Series] Samsung Galaxy s8 Plus Cover/s8+ Hybrid Clear Case [Scratch Resistant] Ergonomic Shock-Absorbing Bumper + PC Hard Back Panel 2017—Clear”, <https://www.amazon.com/dp/B06XPMMM4N>, Earliest review date of Apr. 3, 2017, Downloaded on Jan. 23, 2019.

“Trianium Note 8 Case, Clarium Series for Samsung Galaxy Note 8 Case/Note8 Clear Hybrid Cover [Scratch Resistant] Ergonomic Cushion Shock-Absorbing TPU Bumper + PC Hard Back Panel—Clear (TM000229)”, <https://www.amazon.com/dp/B074F4W8SW>, Earliest review date of Aug. 12, 2017.

* cited by examiner

FIG. 1

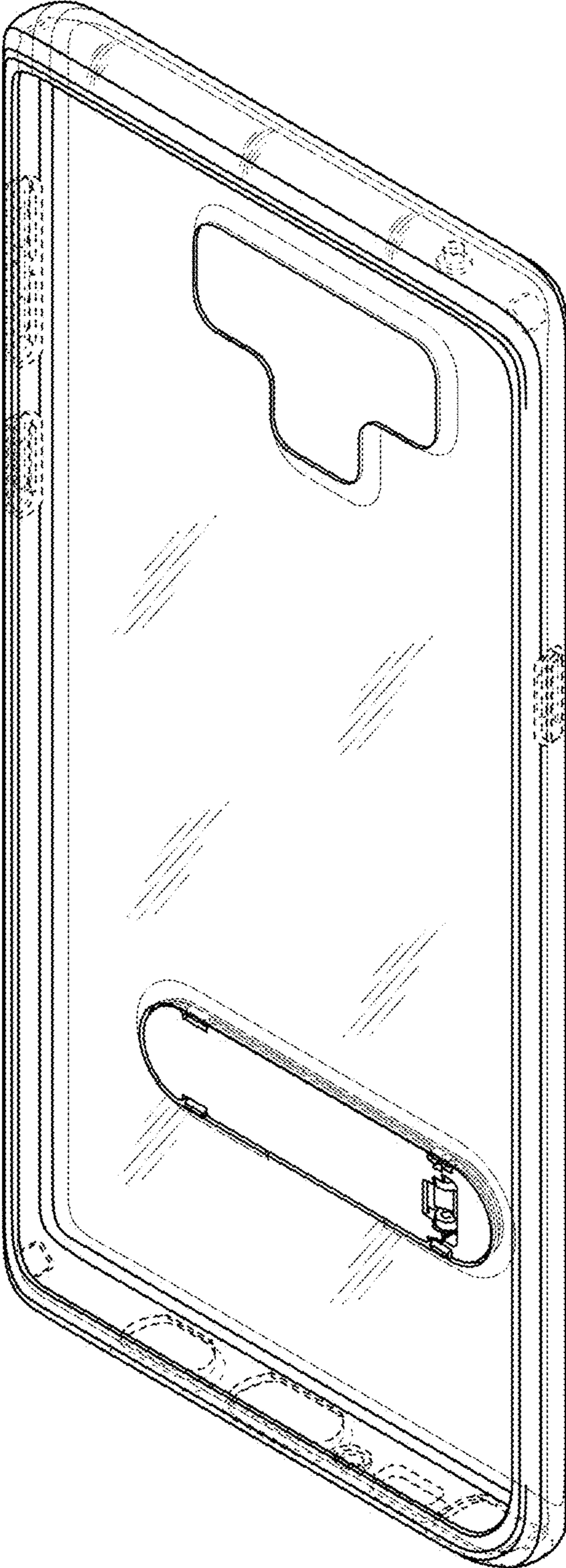

FIG. 2

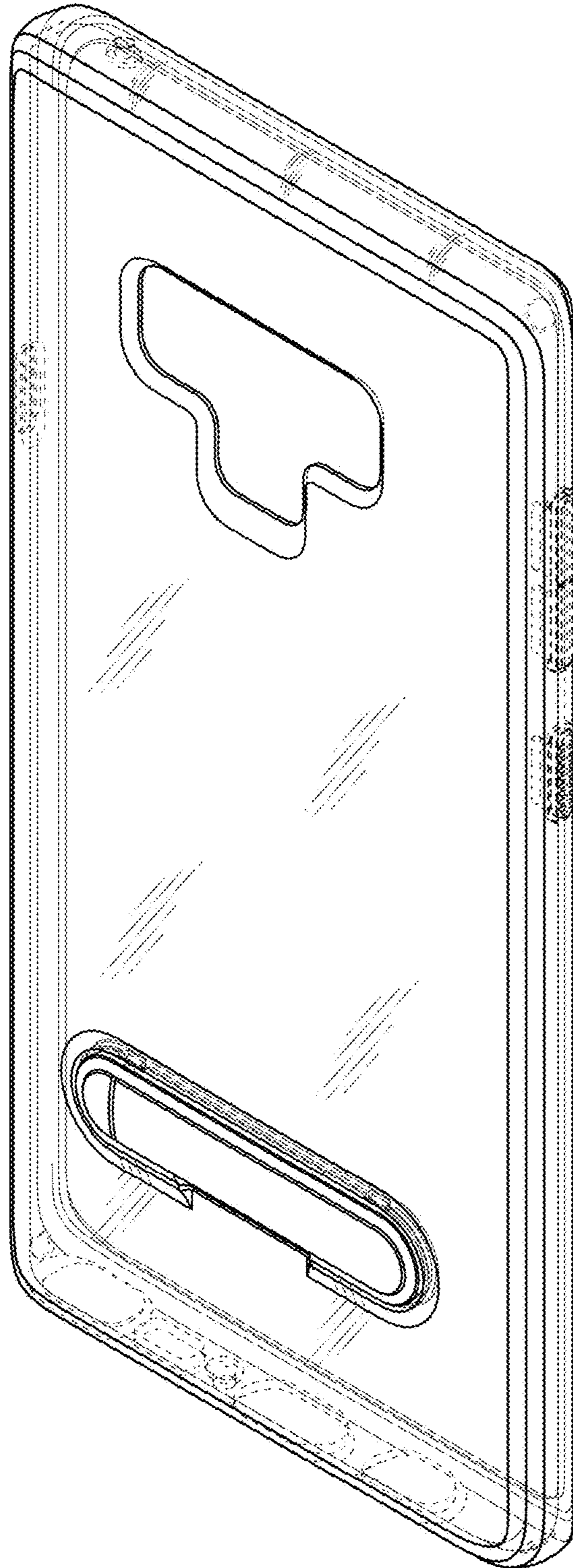

FIG. 3

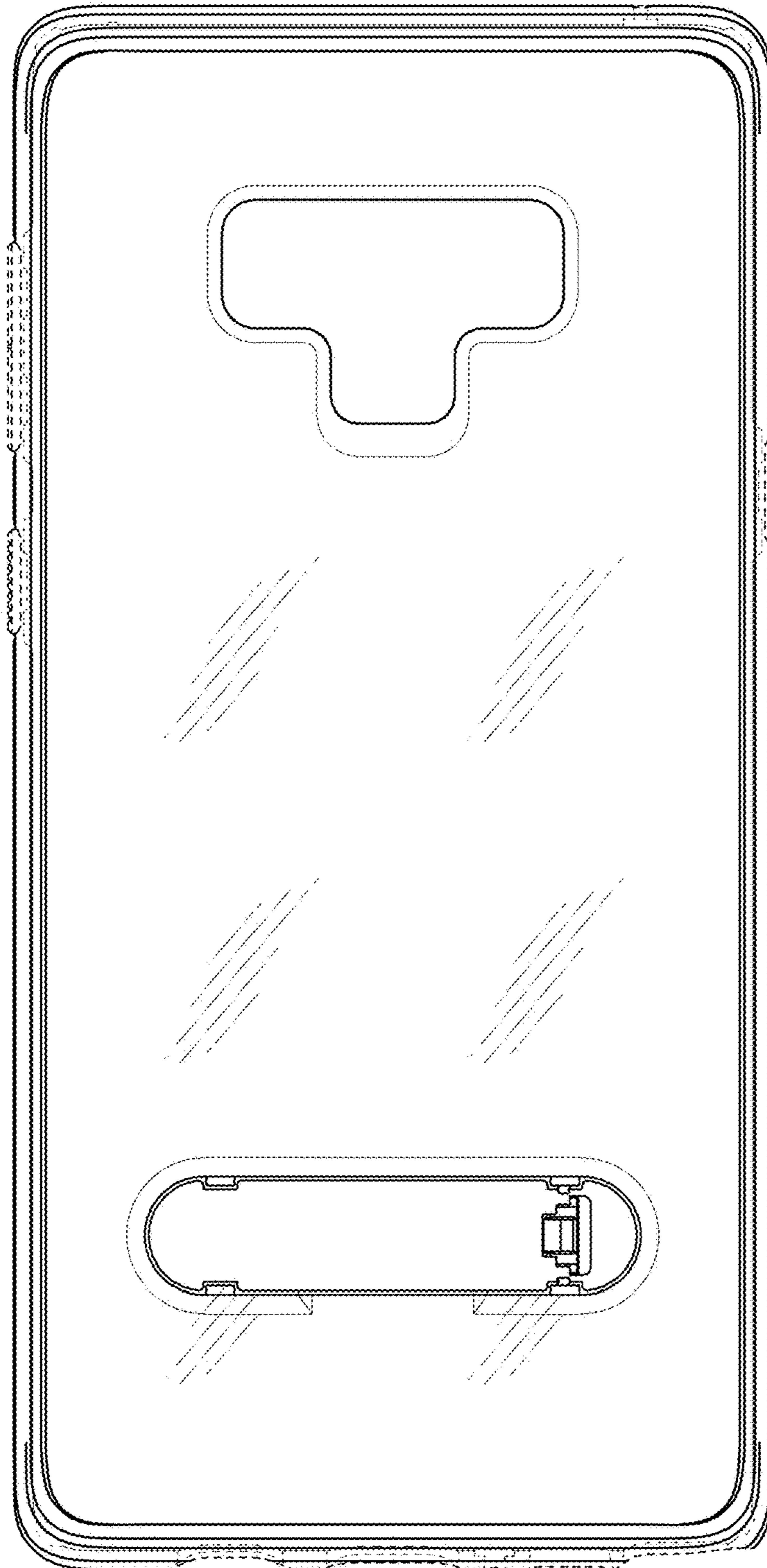

FIG. 4

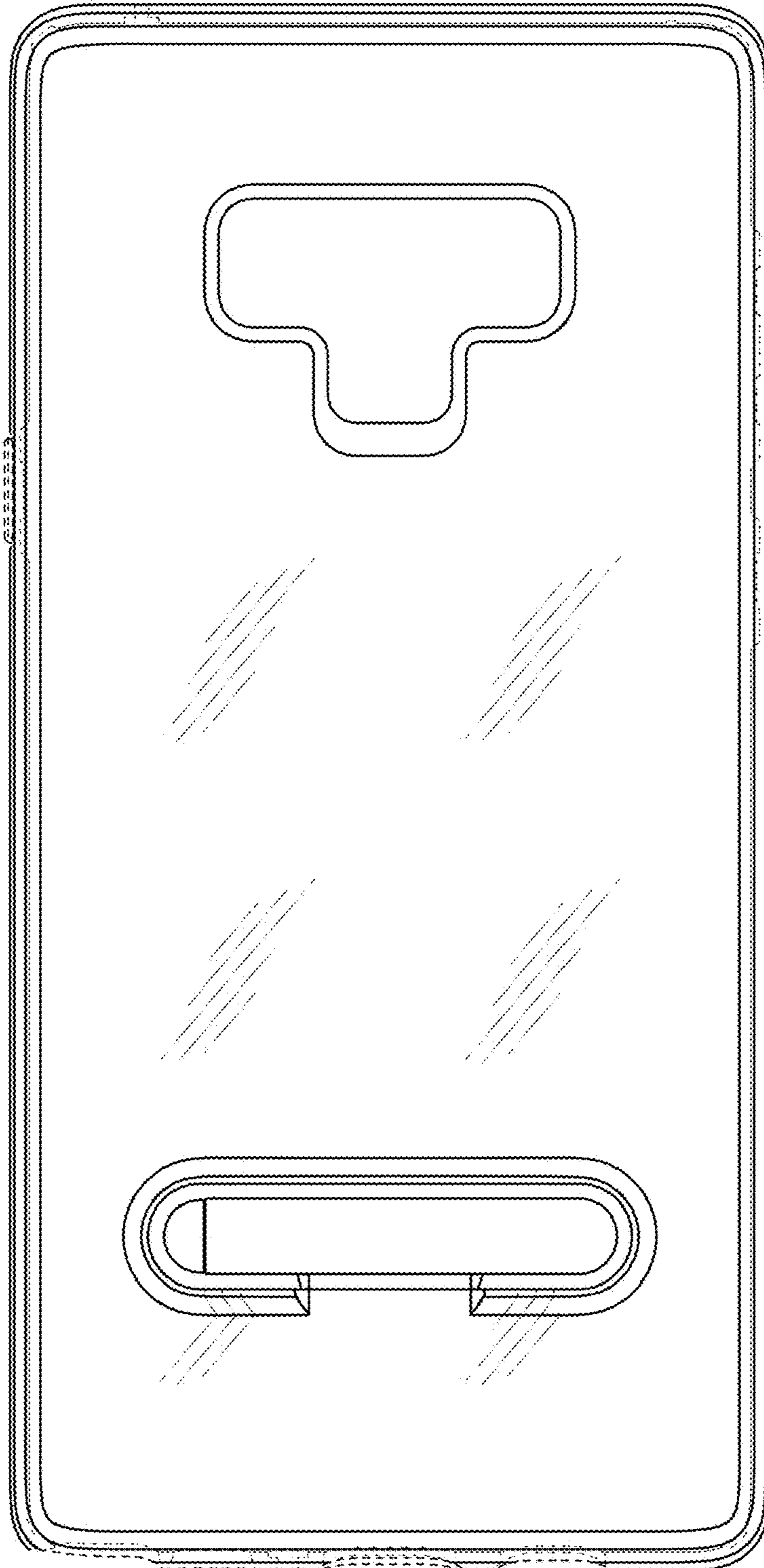

FIG. 5

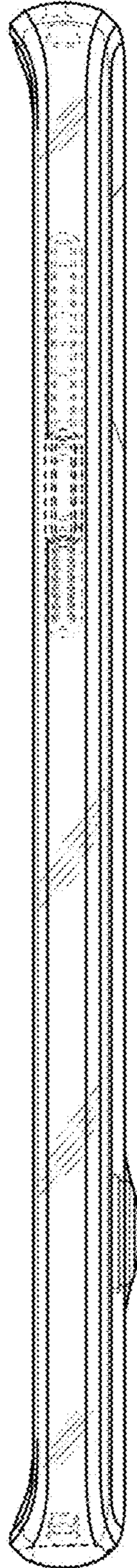

FIG. 6

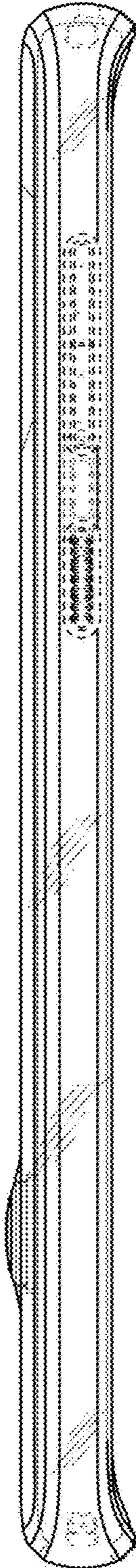

FIG. 7

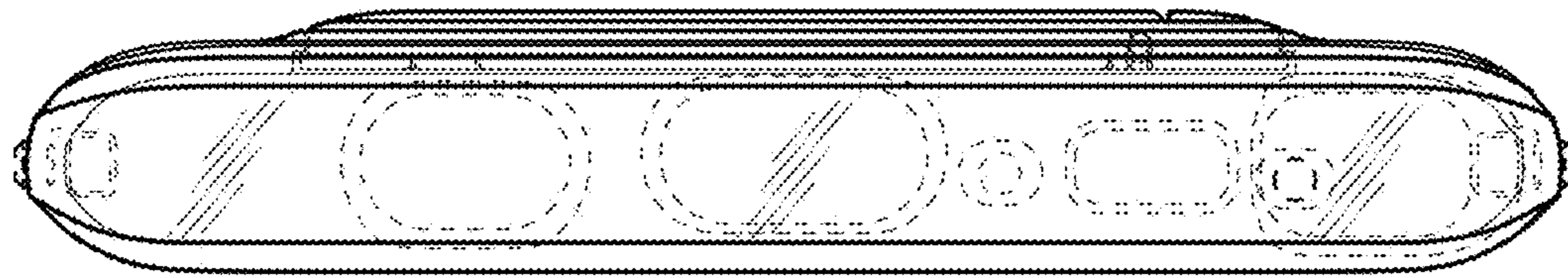

FIG. 8

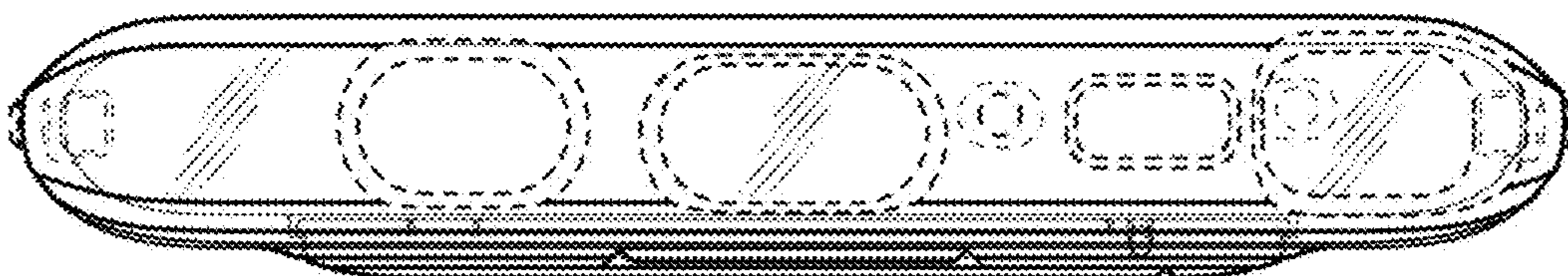

FIG. 9

