



US00D857684S

(12) **United States Design Patent** (10) **Patent No.:** **US D857,684 S**
Lee (45) **Date of Patent:** **** *Aug. 27, 2019**

- (54) **CASE FOR ELECTRONIC COMMUNICATIONS DEVICE**
- (71) Applicant: **SPIGEN KOREA CO., LTD.**, Seoul (KR)
- (72) Inventor: **Jong Hwa Lee**, Seoul (KR)
- (73) Assignee: **SPIGEN KOREA CO., LTD.**, Seoul (KR)
- (*) Notice: This patent is subject to a terminal disclaimer.
- (**) Term: **15 Years**
- (21) Appl. No.: **29/632,495**
- (22) Filed: **Jan. 8, 2018**
- (51) **LOC (12) Cl.** **14-03**
- (52) **U.S. Cl.**
USPC **D14/250**
- (58) **Field of Classification Search**
USPC D3/218, 232, 233, 239, 242, 245-251, D3/269, 273, 301, 303; D13/103, 107, D13/108, 119; D14/137, 138 R, 138 AA, D14/138 C, 138 G, 203.3-203.7, 217, D14/238.1, 247, 248, 250, 251-253, 440
CPC H04B 1/3888; H04M 1/0283; H04M 1/0202; A45C 1/06; A45C 2011/002; A45C 11/00; A45F 2005/028; A45F 2200/0525
See application file for complete search history.

- D643,837 S 8/2011 Smith
- D651,202 S * 12/2011 Fathollahi D14/250
- D656,495 S * 3/2012 Andre D14/250
- D662,924 S * 7/2012 Melanson D14/250
- D662,929 S 7/2012 Fahrendorff et al.
- D671,930 S 12/2012 Akana et al.
- D673,159 S * 12/2012 McCarthy D14/440
- D673,539 S 1/2013 Magness et al.
- D674,789 S 1/2013 Wen
- D679,695 S 4/2013 Fahrendorff et al.
- D680,521 S * 4/2013 Fathollahi D14/250
(Continued)

OTHER PUBLICATIONS

<http://www.spigen.com/collections/galaxy-s6-edge/products/galaxy-s6-edge-case-liquid-crystal>.
(Continued)

Primary Examiner — Susan E Krakower
Assistant Examiner — L. A. Grabenstetter
(74) *Attorney, Agent, or Firm* — Heedong Chae; Lucem, PC

(57) **CLAIM**

The ornamental design for a case for electronic communications device, as shown and described.

DESCRIPTION

FIG. 1 is a front perspective view of a case for electronic communications device showing my new design; FIG. 2 is a rear perspective view thereof; FIG. 3 is a front elevational view thereof; FIG. 4 is a rear elevational view thereof; FIG. 5 is a left side elevational view thereof; FIG. 6 is a right side elevational view thereof; FIG. 7 is a top plan view thereof; and, FIG. 8 is a bottom plan view thereof. The broken lines, and unshaded surfaces bounded by broken lines, depict parts of the article's appearance that form no part of the claimed design.

1 Claim, 8 Drawing Sheets

- (56) **References Cited**
U.S. PATENT DOCUMENTS
- D574,819 S 8/2008 Andre et al.
- D615,077 S 5/2010 Richardson et al.
- D615,536 S 5/2010 Richardson et al.
- D619,361 S 7/2010 Andre
- D623,639 S 9/2010 Richardson et al.
- D623,640 S 9/2010 Freeman
- D643,029 S 8/2011 Feng

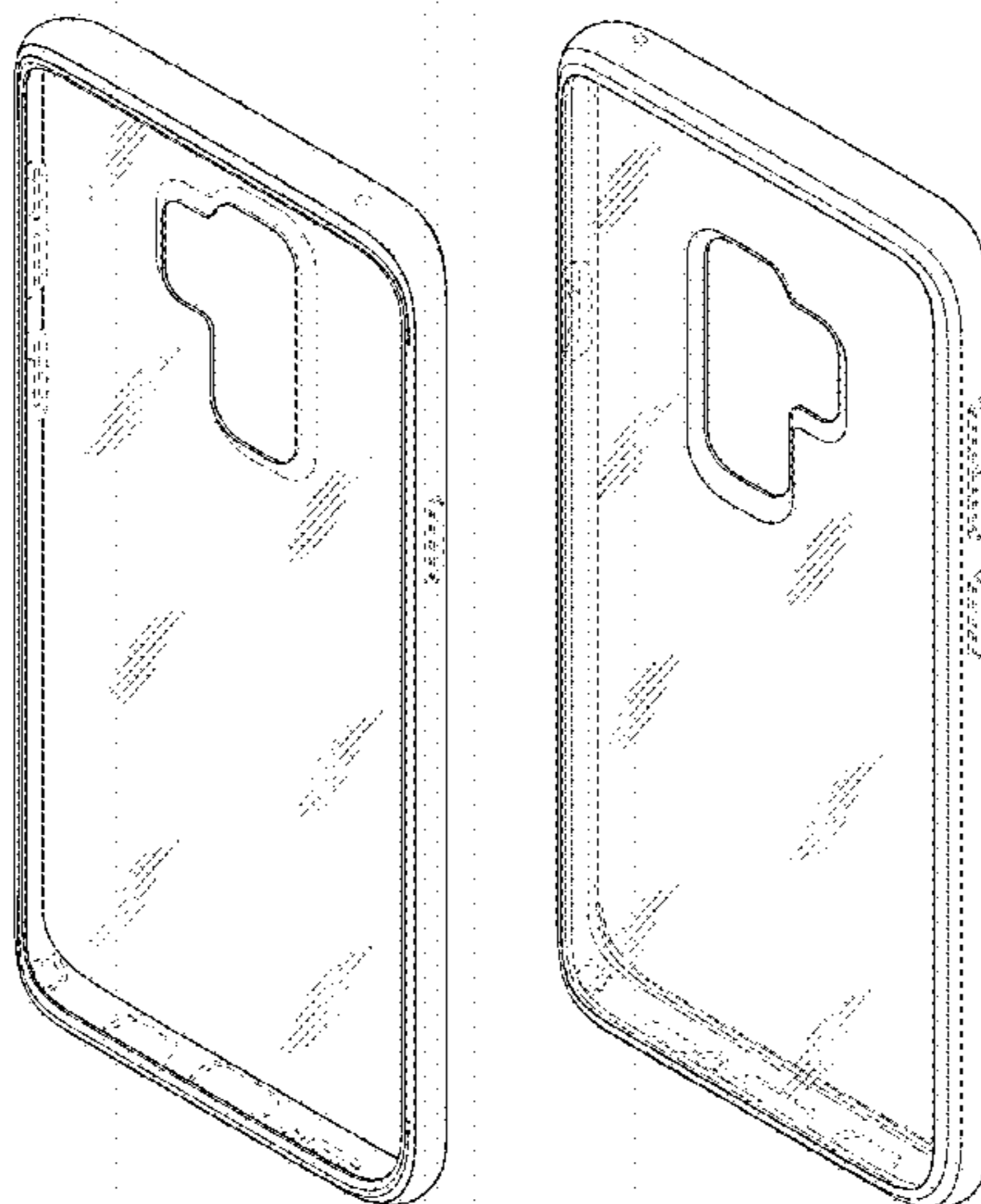

(56)

References Cited

U.S. PATENT DOCUMENTS

D685,780	S	*	7/2013	Murchison	D14/250
D691,992	S	*	10/2013	Murchison	D14/250
D694,224	S		11/2013	Wooseung		
D694,759	S	*	12/2013	Chang	D14/440
D696,238	S		12/2013	Murchison et al.		
D696,240	S		12/2013	Kim et al.		
D697,503	S	*	1/2014	Melanson	D14/250
D706,754	S	*	6/2014	Goradesky	D14/250
D709,869	S	*	7/2014	Witter	D14/250
D712,388	S	*	9/2014	Jia	D14/250
D714,276	S		9/2014	Hu		
D719,945	S	*	12/2014	Chiang	D14/250
D721,071	S		1/2015	Nelson et al.		
D721,360	S	*	1/2015	Laffon de Mazieres	D14/250
D721,693	S		1/2015	Lee et al.		
9,059,505	B1	*	6/2015	Asrani	H01Q 9/145
D739,394	S		9/2015	Rayner et al.		
D741,845	S		10/2015	Kim		
D744,472	S	*	12/2015	Lerenthal	D14/250
D746,805	S		1/2016	Kim		
D747,708	S		1/2016	Roberts		
D749,535	S		2/2016	Joung		
9,293,808	B1	*	3/2016	Roberts	H01Q 1/2266
D754,652	S	*	4/2016	Roberts	D14/250
D756,343	S		5/2016	Wall et al.		
D756,345	S	*	5/2016	Roberts	D14/250
D763,241	S		8/2016	Kim		
D765,627	S		9/2016	Watt		
D765,633	S		9/2016	Northrup et al.		
D765,643	S	*	9/2016	Witter	D14/250
D765,645	S		9/2016	Kim		
D771,027	S	*	11/2016	Prstojevich	D14/250
D771,612	S		11/2016	Roberts et al.		
D771,613	S		11/2016	Poon et al.		
D772,854	S	*	11/2016	Igarashi	D14/250
D773,445	S		12/2016	Witter et al.		
D776,647	S		1/2017	Kim		
D777,157	S		1/2017	Kim		
D777,159	S		1/2017	Lee et al.		
D781,835	S		3/2017	Kim et al.		
D781,836	S		3/2017	Kim et al.		
D781,837	S		3/2017	Kim et al.		
D781,838	S		3/2017	Kim et al.		
D781,839	S		3/2017	Kim et al.		
D781,840	S		3/2017	Kim et al.		
D782,453	S		3/2017	Kim et al.		
D782,454	S		3/2017	Kim et al.		
D784,309	S		4/2017	Lee et al.		
D786,848	S		5/2017	Park et al.		
D786,849	S		5/2017	Park et al.		
D792,394	S		7/2017	Lee et al.		
D795,237	S		8/2017	Jung et al.		
D797,715	S		9/2017	Kim		
D798,853	S		10/2017	Park et al.		
D801,322	S		10/2017	Song et al.		
D808,955	S		1/2018	Park et al.		
2015/0195938	A1	*	7/2015	Witter	H05K 5/03 206/521
2015/0245522	A1		8/2015	Kang		
2015/0180526	A1		9/2015	Hidaka		
2016/0058143	A1	*	3/2016	Tien	A45C 11/00 224/191
2016/0198026	A1	*	7/2016	Del Toro	H04B 1/3888 455/575.8
2016/0359517	A1	*	12/2016	Roberts	H04B 1/3888

OTHER PUBLICATIONS

<http://www.spigen.com/collections/galaxy-s7-edge/products/galaxy-s7-edge-case-ultra-hybrid?variant=11972968705>, Earliest review date of Mar. 21, 2016.
<http://www.spigen.com/collections/galaxy-s6-edge/products/galaxy-s6-edge-case-ultra-hybrid?variant=1161533381>, Earliest review date of Jun. 14, 2015.

Nick Guy, “Review: Griffin Reveal Case for iPhone 5”, <http://www.ilounge.com/index.php/reviews/entry/griffin-reveal-case-for-iphone-5>, Published on Oct. 16, 2012, Downloaded on Feb. 6, 2019.
 “Spigen Ultra Hybrid iPhone 5S/5 Case with Air Cushion Technology and Hybrid Drop Protection for iPhone 5S/iPhone 5—Crystal Clear”, <https://www.amazon.com/dp/B00G3JCFNC>, Earliest review date of Sep. 10, 2013, Downloaded on Aug. 8, 2018.
 Nick Guy, “Review: Griffin Reveal for iPhone 5c”, <http://www.ilounge.com/index.php/reviews/entry/griffin-reveal-for-iphone-5c>, Published on Oct. 10, 2013, Downloaded on Feb. 5, 2019.
 “Spigen Ultra Hybrid Nexus 5 Case with Air Cushion Technology and Hybrid Drop Protection for Nexus 5—Black”, <https://www.amazon.com/dp/B00FJJ38HY>, Earliest review date of Nov. 1, 2013, Downloaded on Jan. 8, 2019.
 “Spigen Ultra Hybrid iPhone 6 Case with Air Cushion Technology and Hybrid Drop Protection for iPhone 6S/iPhone 6—Crystal Clear”, <https://www.amazon.com/dp/B00JH88D1O>, Earliest review date of Jul. 10, 2014, Downloaded on Dec. 28, 2018.
 “Spigen Ultra Hybrid Galaxy Note 4 Case with Air Cushion Technology and Hybrid Drop Protection for Samsung Galaxy Note 4 2014—Gunmetal”, <https://www.amazon.com/dp/B00MAWPXVW>, Earliest review date of Oct. 15, 2014, Downloaded on Aug. 8, 2018.
 “Spigen Ultra Hybrid Galaxy Note 4 Case with Air Cushion Technology and Hybrid Drop Protection for Samsung Galaxy Note 4 2014—Crystal Clear”, <https://www.amazon.com/dp/B00MAWPVXM>, Earliest review date of Oct. 17, 2014, Downloaded on Aug. 8, 2018.
 “Spigen Ultra Hybrid Galaxy S6 Case with Air Cushion Technology and Hybrid Drop Protection for Galaxy S6 2015—Crystal Clear”, <https://www.amazon.com/dp/B00QU4PN84>, Earliest review date of Feb. 6, 2015, Downloaded on Aug. 8, 2018.
 “Spigen Ultra Hybrid Galaxy S6 Edge Case with Air Cushion Technology and Hybrid Drop Protection for Galaxy S6 Edge 2015—Metal Slate”, <https://www.amazon.com/dp/B00SV63NNG>, Earliest review date of Mar. 30, 2015, Downloaded on Aug. 8, 2018.
 “Spigen Ultra Hybrid Galaxy S6 Edge Plus Case with Air Cushion Technology and Hybrid Drop Protection for Galaxy S6 Edge Plus 2015—Mint”, <https://www.amazon.com/dp/B010MWFREFI>, Earliest review date of Aug. 18, 2015, Downloaded on Aug. 8, 2018.
 “Spigen Ultra Hybrid iPhone 6S Case with Air Cushion Technology and Hybrid Drop Protection for iPhone 6S/iPhone 6—Crystal Clear”, <https://www.amazon.com/dp/B010MVJNTK>, Earliest review date of Aug. 31, 2015, Downloaded on Dec. 28, 2018.
 “iPhone 6s Plus Case, Spigen [Ultra Hybrid] Air Cushion [Crystal Clear] Clear back panel + TPU bumper for iPhone 6 Plus (2014)/6s Plus (2015)—Crystal Clear (SGP11644)”, <https://www.amazon.com/dp/B010MVRC20>, Earliest review date of Sep. 15, 2015, Downloaded on Jan. 4, 2019.
 “Spigen Ultra Hybrid Nexus 5X Case with Air Cushion Technology and Hybrid Drop Protection for Nexus 5X—Crystal Clear”, <https://www.amazon.com/dp/B0147JXWG8>, Earliest review date of Sep. 24, 2015, Downloaded on Jan. 8, 2019.
 “Spigen Ultra Hybrid Tech iPhone 6S Plus Case with Bumper Protection for iPhone 6S Plus 2015—Crystal White”, <https://www.amazon.com/dp/B013TKNIOC>, Earliest review date of Oct. 26, 2015, Downloaded on Jan. 4, 2019.
 “Spigen Ultra Hybrid Galaxy S7 Edge Case with Air Cushion Technology and Hybrid Drop Protection for Samsung Galaxy S7 Edge 2016—Rose Crystal”, <https://www.amazon.com/dp/B01AUR0Z1G>, Earliest review date of Feb. 24, 2016, Downloaded on Aug. 8, 2018.
 “Spigen Ultra Hybrid Galaxy S7 Case with Air Cushion Technology and Hybrid Drop Protection for Samsung Galaxy S7 2016—Crystal Clear”, <https://www.amazon.com/dp/B01A7ID0AG>, Earliest review date of Feb. 29, 2016, Downloaded on Aug. 8, 2018.
 “Spigen Ultra Hybrid iPhone SE Case with Air Cushion Technology and Hybrid Drop Protection for iPhone SE 2016—Crystal Clear”, <https://www.amazon.com/dp/B01BEDO0OS>, Earliest review date of Apr. 15, 2016, Downloaded on Jan. 4, 2019.
 “Spigen Ultra Hybrid Galaxy A5 Case with Air Cushion Technology and Hybrid Drop Protection for Galaxy A5—Crystal Clear”, <https://www.amazon.com/dp/B018J07DOI>, Earliest review date of May 23, 2016, Downloaded on Aug. 8, 2018.

(56)

References Cited

OTHER PUBLICATIONS

“Spigen Ultra Hybrid iPhone 7 Case with Air Cushion Technology and Hybrid Drop Protection for iPhone 7 2016—Black”, <https://www.amazon.com/dp/B01GIVXBVY>, Earliest review date of Sep. 1, 2016, Downloaded on Jan. 8, 2019.

“Spigen Ultra Hybrid iPhone 7 Plus Case with Air Cushion Technology and Hybrid Drop Protection for Apple iPhone 7 Plus 2016—Crystal Clear”, <https://www.amazon.com/dp/B01GIWGFMU>, Earliest review date of Sep. 6, 2016, Downloaded on Jan. 8, 2019.

“Spigen Ultra Hybrid S iPhone Seven Plus Case with Air Cushion Technology and Magnetic Metal Kickstand for Apple iPhone Seven Plus Two Thousand and Sixteen Clear Black”, <https://www.amazon.com/dp/B01LRSF986>, Earliest review date of Sep. 7, 2016, Downloaded on Jan. 8, 2019.

“Spigen Ultra Hybrid S iPhone 7 Case with Air Cushion Technology and Magnetic Metal Kickstand for iPhone 7 2016—Crystal Clear”, <https://www.amazon.com/dp/B01J9DVBWE>, Earliest review date of Sep. 13, 2016, Downloaded on Jan. 8, 2019.

“Spigen Ultra Hybrid Google Pixel XL Case with Air Cushion Technology and Hybrid Drop Protection for Google Pixel XL 2016—Crystal Clear”, <https://www.amazon.com/dp/B01M12Z4VQ>, Earliest review date of Oct. 21, 2016, Downloaded on Jan. 8, 2019.

* cited by examiner

FIG. 1

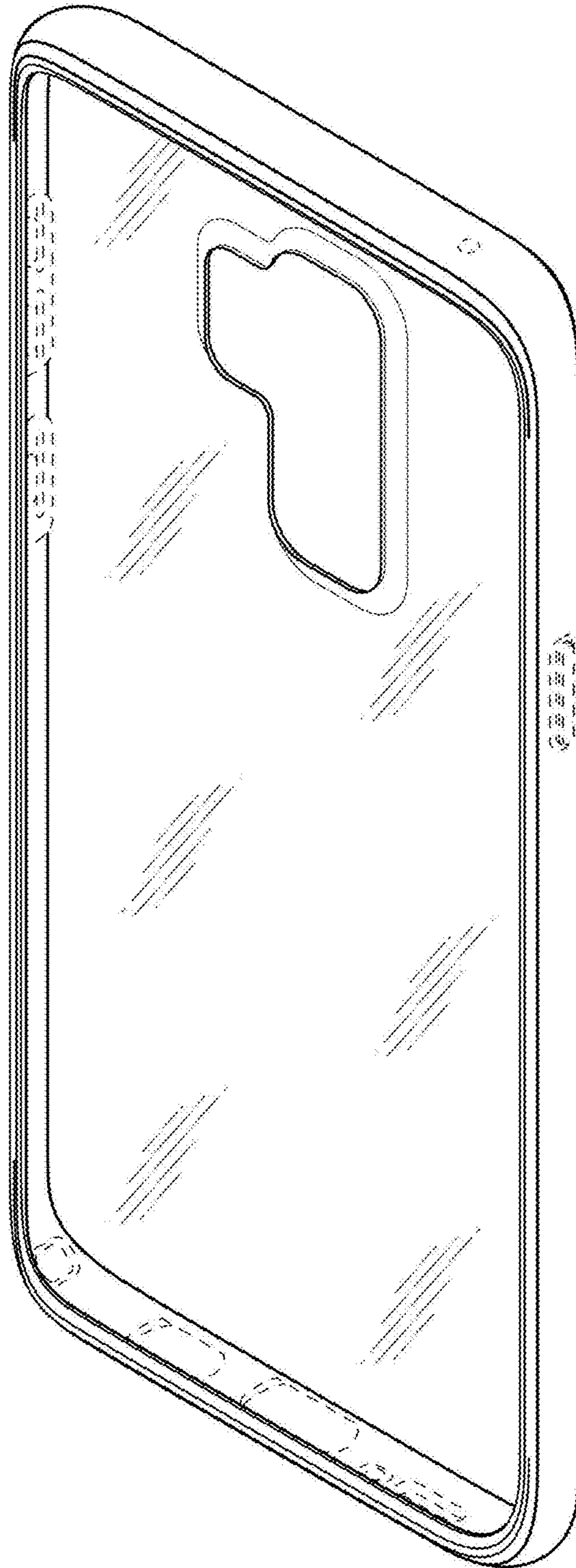

FIG. 2

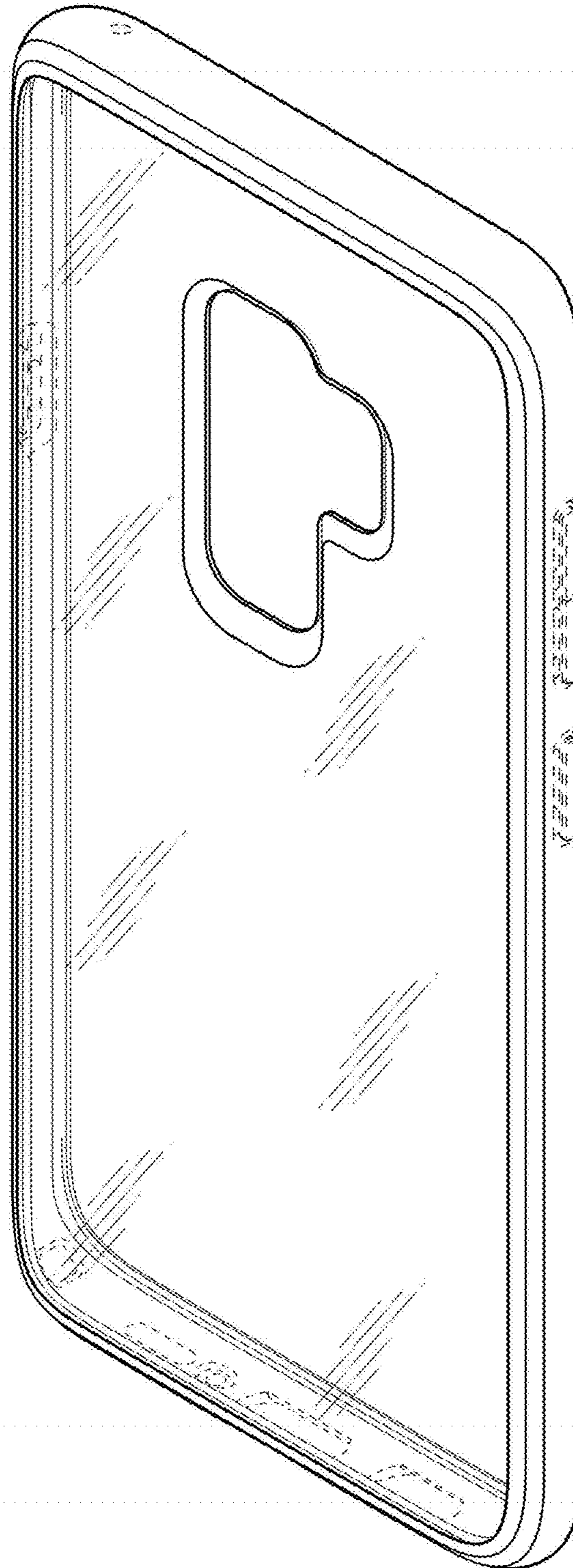

FIG. 3

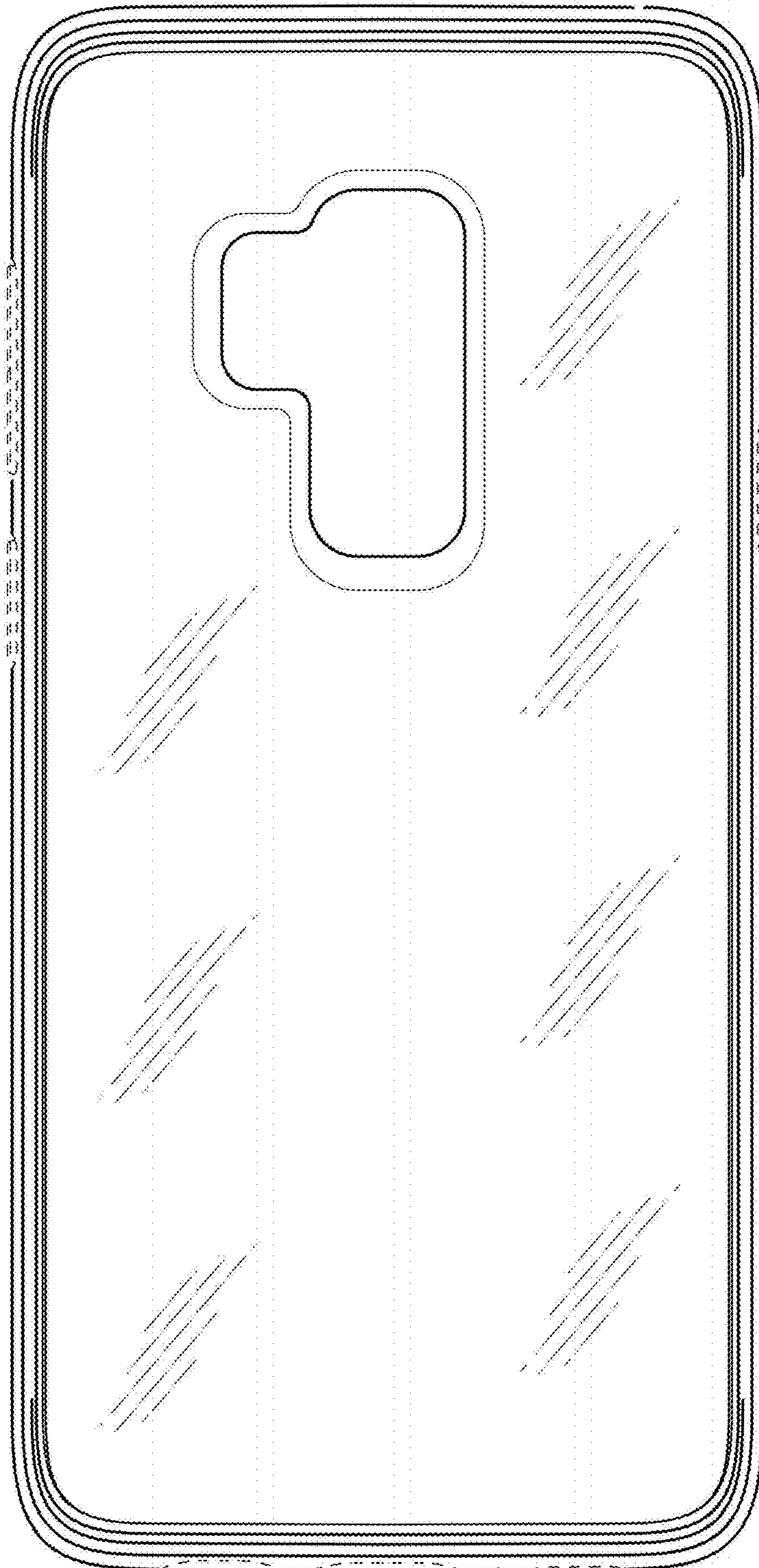

FIG. 4

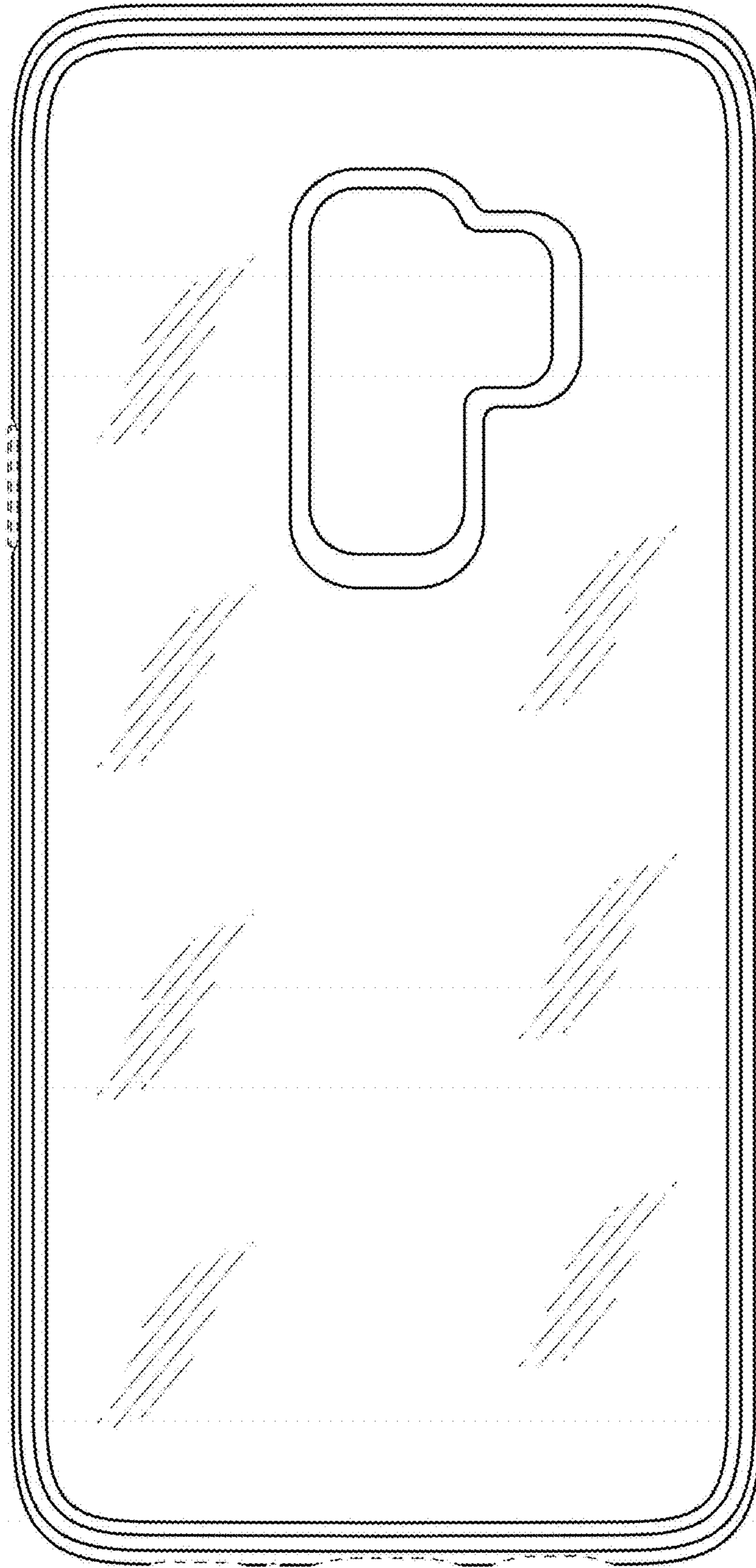

FIG. 5

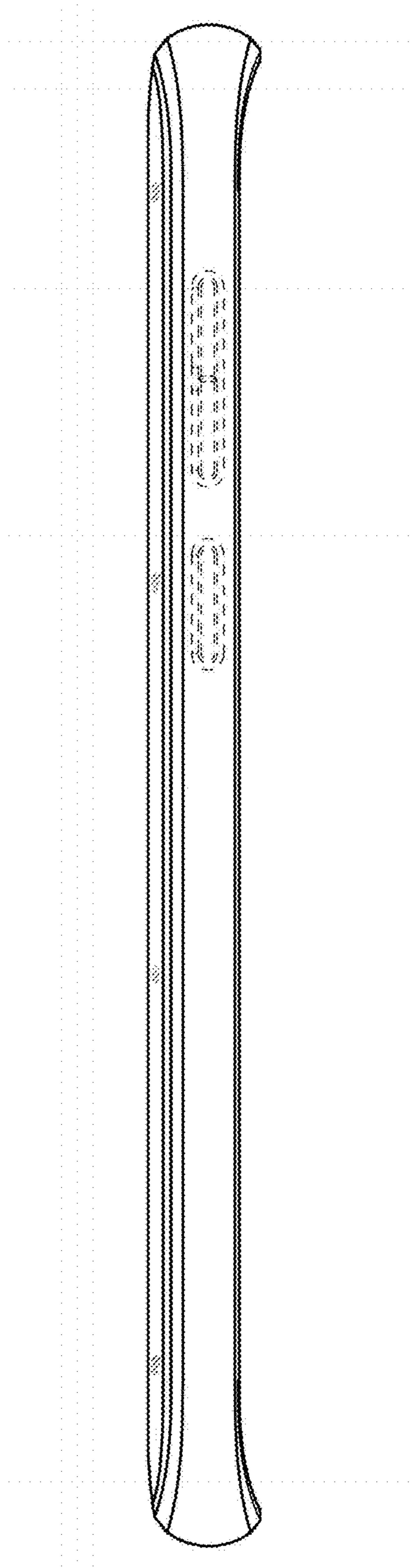

FIG. 6

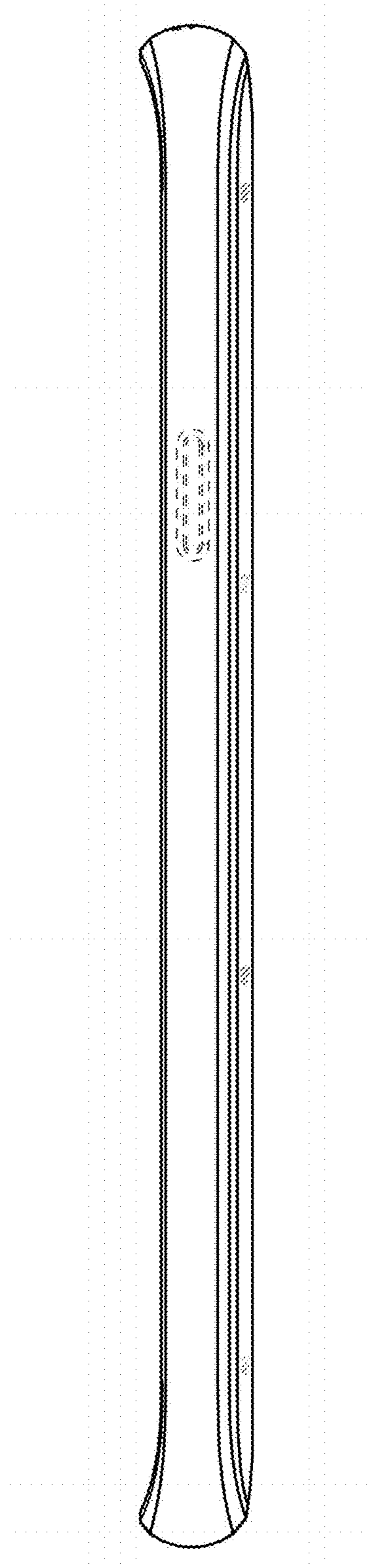

FIG. 7

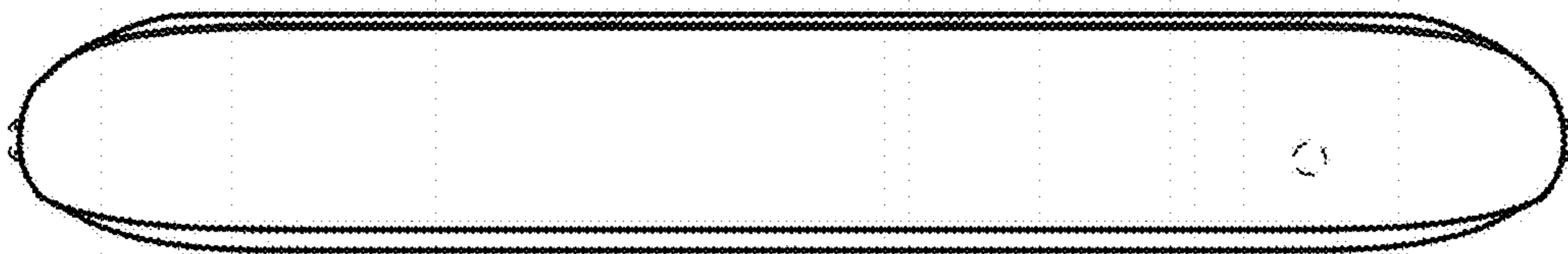

FIG. 8

