



US00D857572S

(12) **United States Design Patent**  
**Spencer et al.**

(10) **Patent No.:** **US D857,572 S**

(45) **Date of Patent:** **\*\* Aug. 27, 2019**

(54) **AUTOMOTIVE ACCESSORY FOR MUD  
FLAP**

(71) Applicant: **Cruiser Accessories, LLC**, Monument,  
CO (US)

(72) Inventors: **Todd R. Spencer**, Monument, CO  
(US); **M. Hunter Basenberg, Jr.**,  
Colorado Springs, CO (US)

(73) Assignee: **Cruiser Accessories, LLC**, Monument,  
CO (US)

(\*\*) Term: **15 Years**

(21) Appl. No.: **29/634,716**

(22) Filed: **Jan. 24, 2018**

(51) **LOC (12) Cl.** ..... **12-16**

(52) **U.S. Cl.**  
USPC ..... **D12/185**

(58) **Field of Classification Search**  
USPC ..... D12/90-92, 93, 96, 181, 184, 185, 196,  
D12/202

CPC ..... B62D 25/18; B62D 25/188  
See application file for complete search history.

(56) **References Cited**

U.S. PATENT DOCUMENTS

D241,827 S *	10/1976	Podall	.....	D12/185
D260,759 S *	9/1981	Arenhold	.....	D12/185
4,315,634 A *	2/1982	Arenhold	.....	B62D 25/18 280/851
D274,324 S *	6/1984	Arenhold	.....	D12/185
D279,560 S *	7/1985	Jensen	.....	D12/185
D281,966 S *	12/1985	Lockwood	.....	D12/185
D282,158 S *	1/1986	Wright	.....	D12/185
D301,710 S *	6/1989	Ward	.....	D12/185
D308,847 S *	6/1990	Price	.....	D12/185
D308,958 S *	7/1990	Knox	.....	D12/185

D309,724 S *	8/1990	Jurgens	.....	D12/185
D328,447 S *	8/1992	Ahleen	.....	D12/185
D332,770 S *	1/1993	Rutter	.....	D12/185
5,407,229 A *	4/1995	Garrett	.....	B62D 25/18 280/851
D406,087 S *	2/1999	Bavington	.....	D12/185
D415,460 S *	10/1999	Ward	.....	D12/185
6,179,311 B1 *	1/2001	Larkin	.....	B62D 25/188 280/154
D615,468 S *	5/2010	Harris	.....	D12/185
9,004,538 B2 *	4/2015	Eklund	.....	B62D 25/188 280/762
D792,823 S *	7/2017	Senatro	.....	D12/185
9,724,974 B2 *	8/2017	Schmeichel	.....	B60D 1/58

\* cited by examiner

*Primary Examiner* — Darlington Ly

(74) *Attorney, Agent, or Firm* — Linda Flewellen Gould

(57) **CLAIM**

The ornamental design for an automotive accessory for mud flap, as shown and described.

**DESCRIPTION**

FIG. 1 is a front elevation view of an automotive accessory for mud flap showing our new design;  
 FIG. 2 is a top plan view thereof;  
 FIG. 3 is a bottom plan view thereof;  
 FIG. 4 is a right side elevation view thereof;  
 FIG. 5 is a left side elevation view thereof;  
 FIG. 6 is a front perspective view thereof;  
 FIG. 7 is a front elevation view thereof when mounted to an exemplary mud flap; and,  
 FIG. 8 is a perspective view thereof when mounted to an exemplary mud flap.  
 The broken line showings of the mud flap and mud flap mounting hardware are provided for the purpose of illustrating environmental structures and form no part of the claimed design.

**1 Claim, 3 Drawing Sheets**

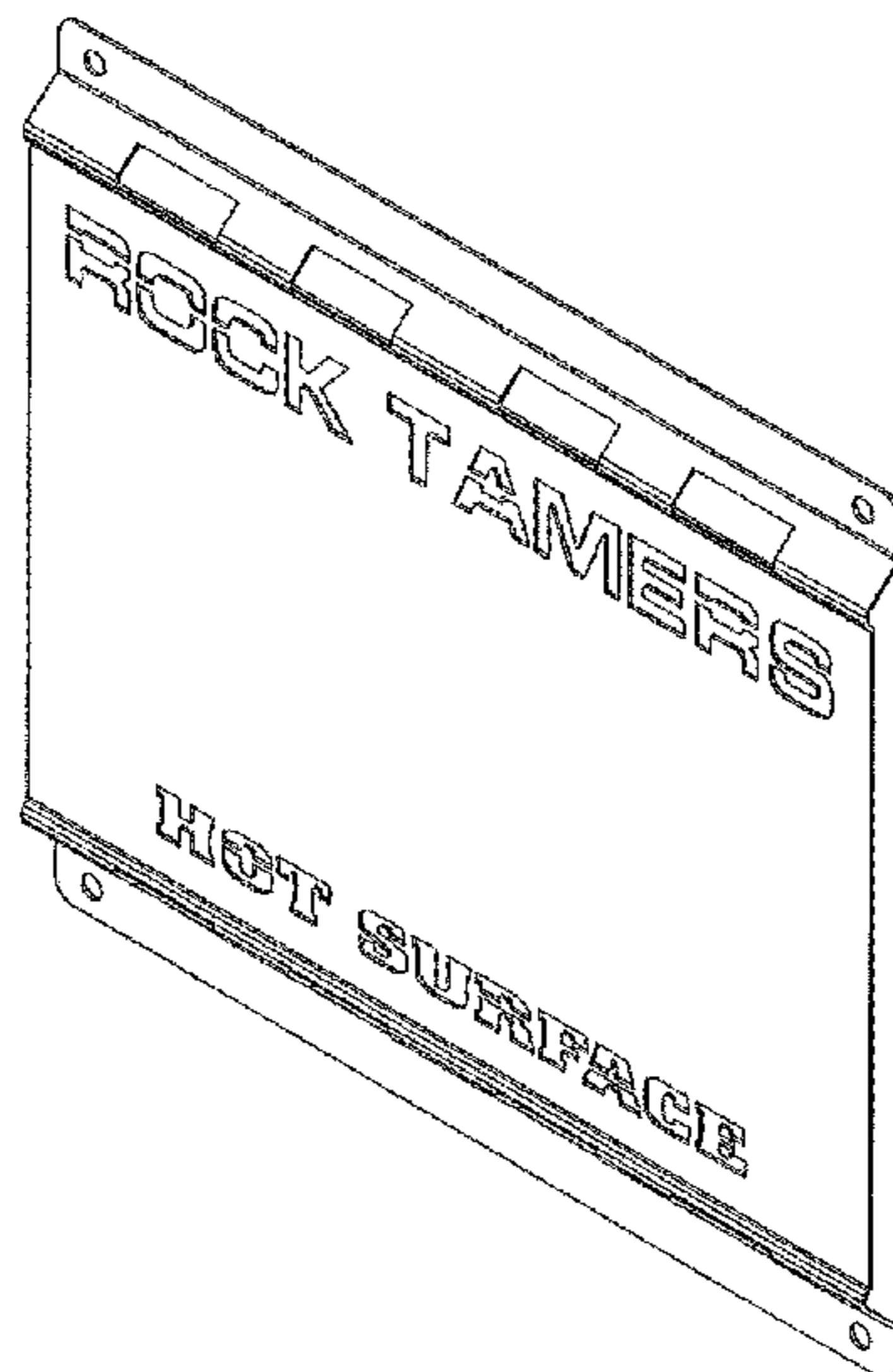

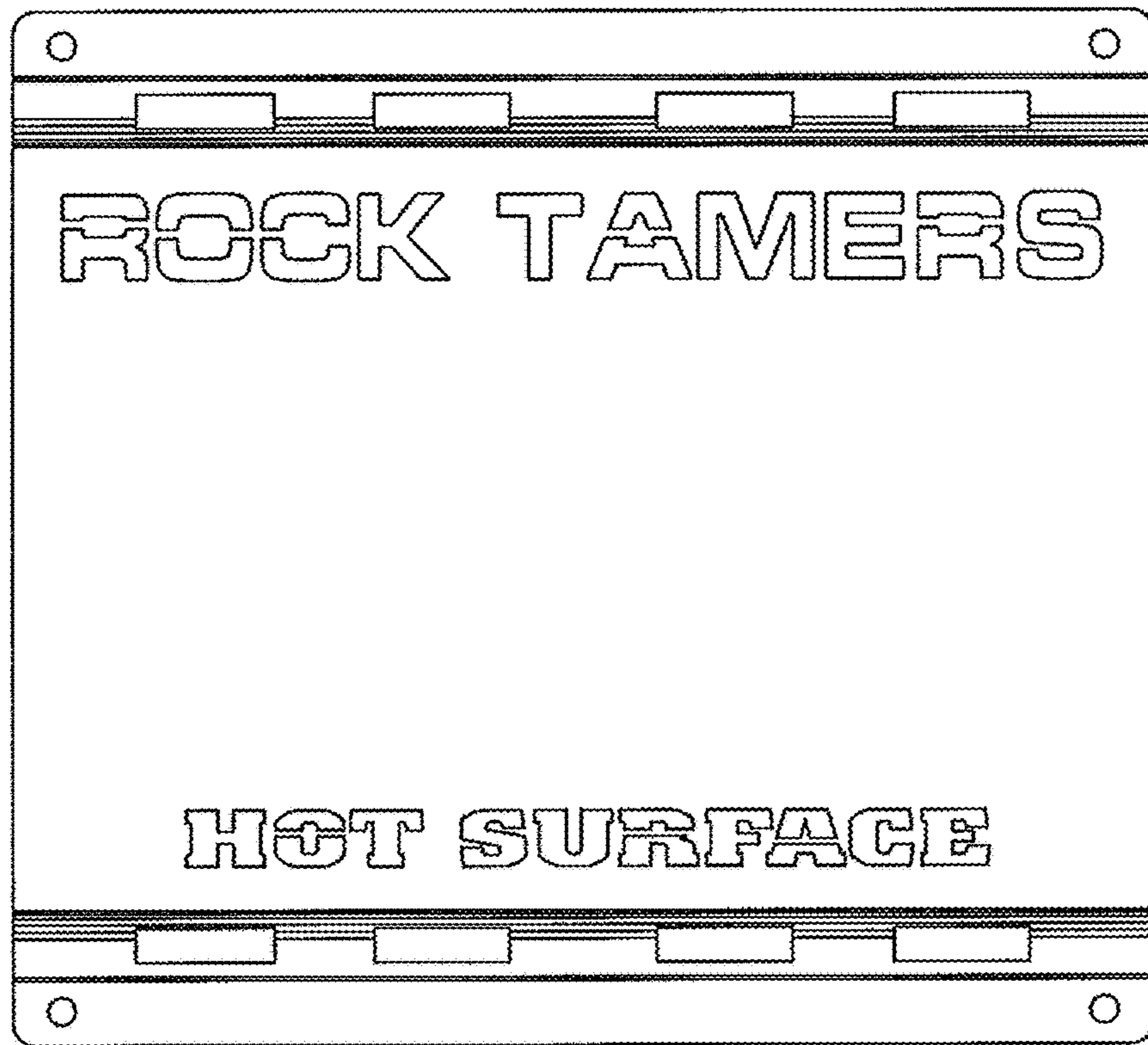

Figure 1



Figure 2

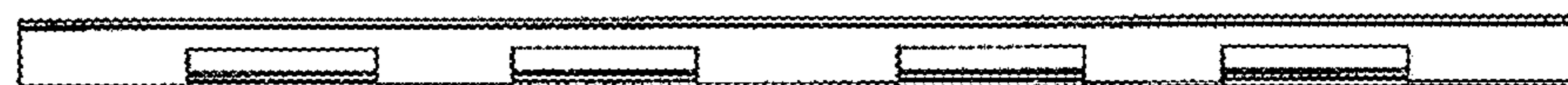

Figure 3

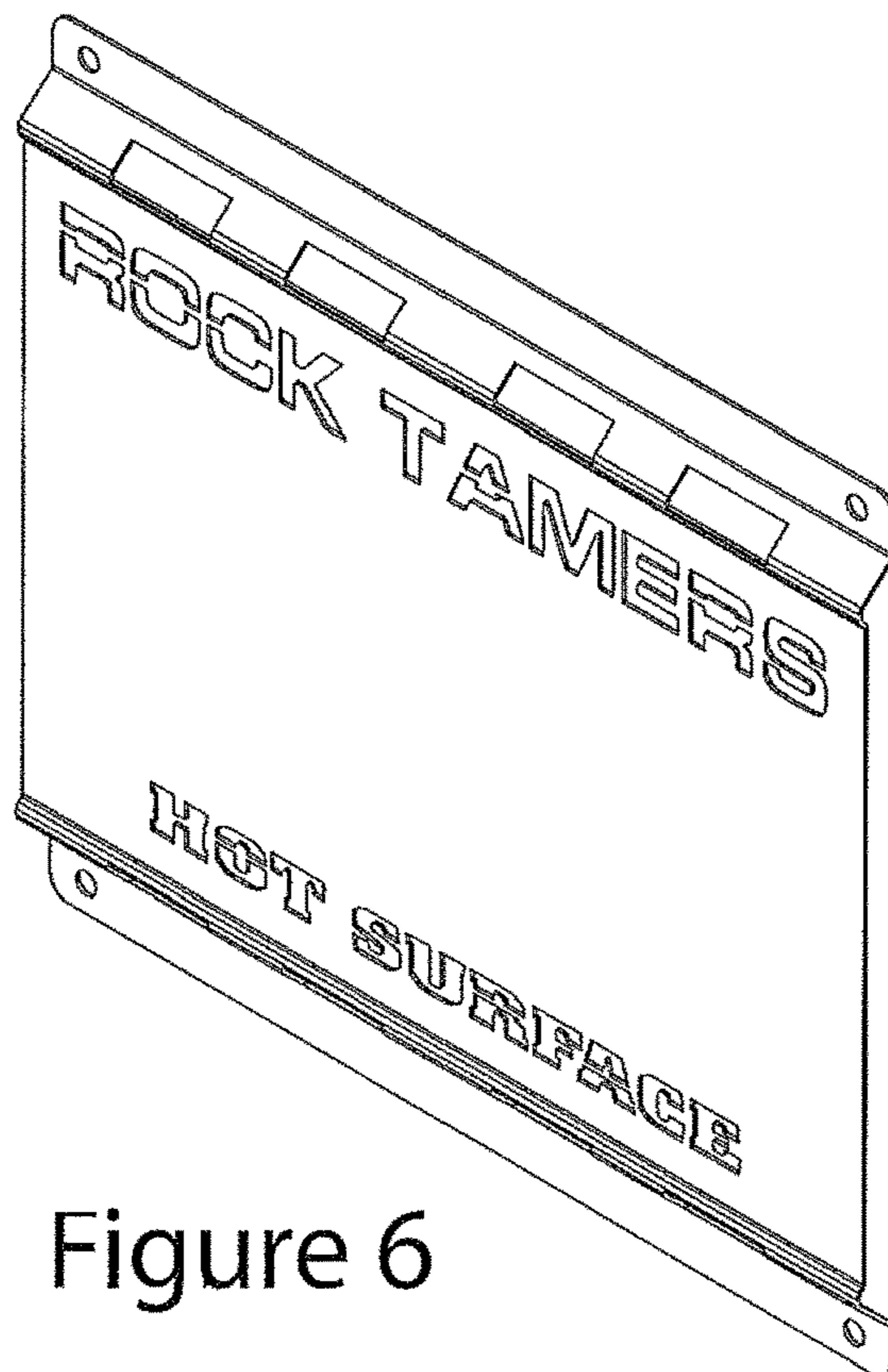
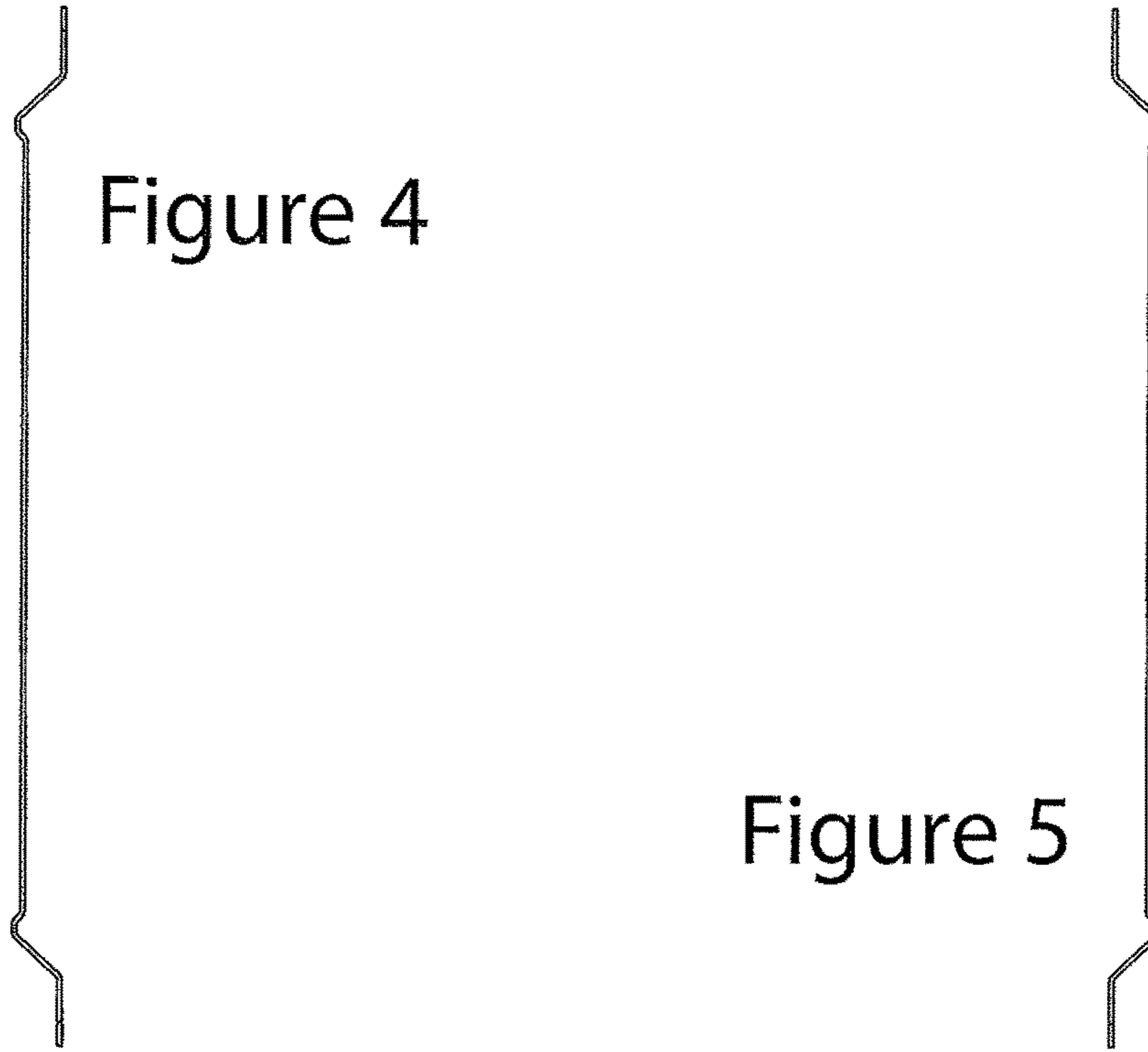

Figure 6

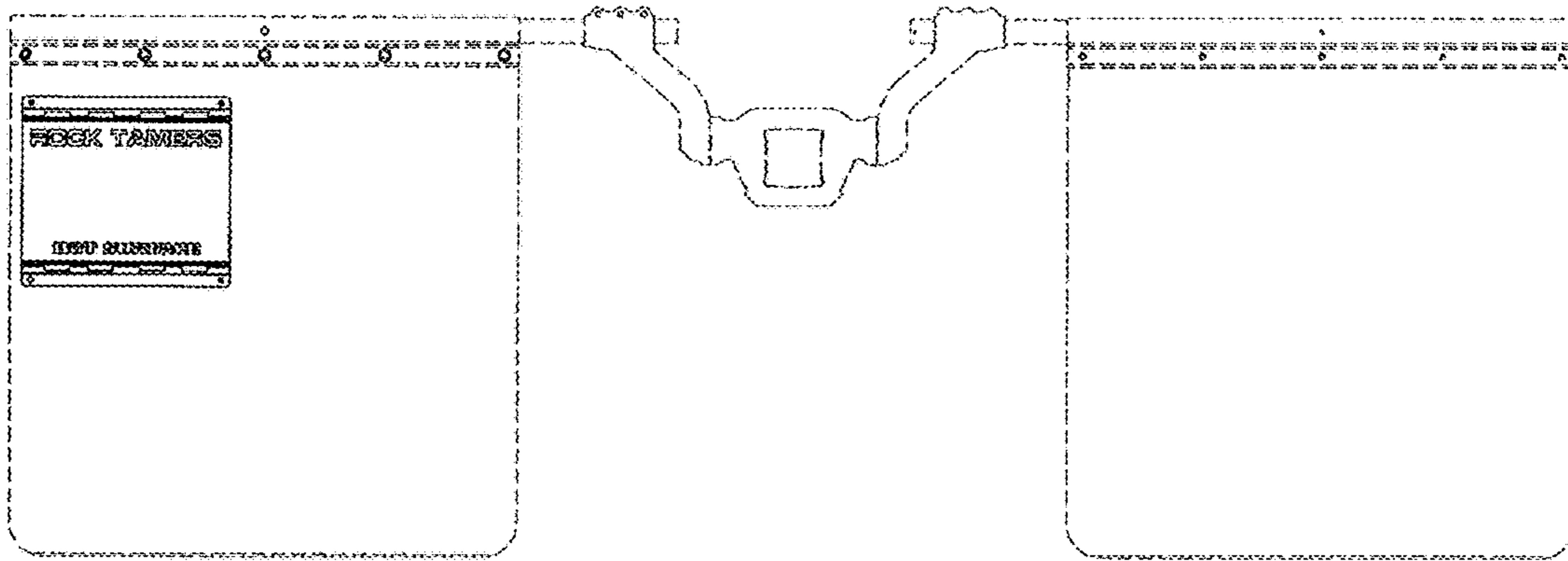

Figure 7

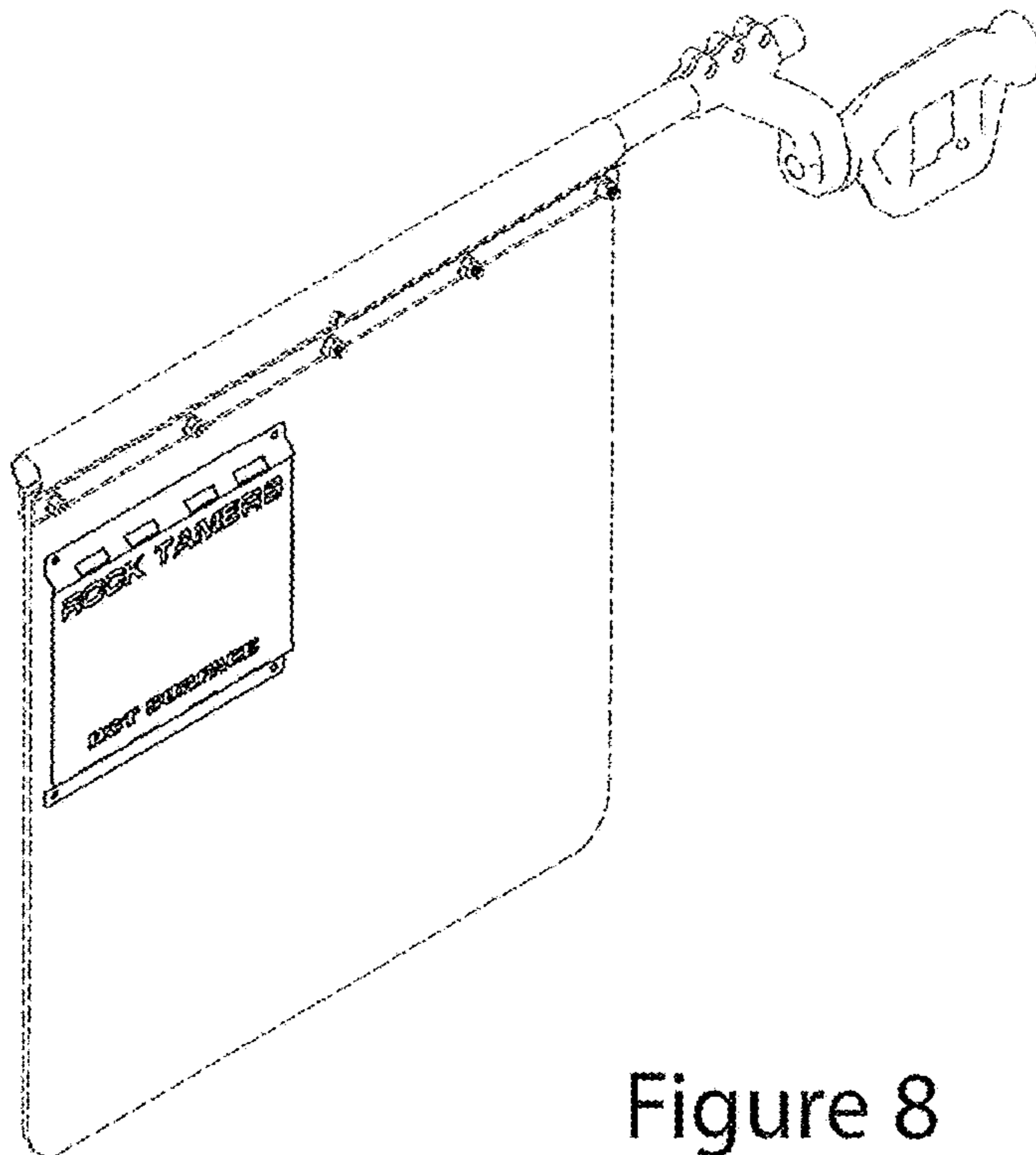

Figure 8