



US00D857519S

(12) **United States Design Patent**
Sheerin et al.

(10) **Patent No.:** **US D857,519 S**

(45) **Date of Patent:** **** Aug. 27, 2019**

(54) **POUCH AND CLEANING COMPOSITION**

(71) Applicant: **S. C. Johnson & Son, Inc.**, Racine, WI (US)

(72) Inventors: **Shabistan Sheerin**, Mequon, WI (US); **Douglas A. Soller**, Racine, WI (US); **John Bruno**, Mineola, NY (US); **Diana Maureen Luistro**, Elmhurst, NY (US); **Leonard Joseph DiChiara**, Chatham, NJ (US); **Jason Craig Campbell**, Chicago, IL (US); **Gregory A. Falduto**, Grayslake, IL (US)

(73) Assignee: **S. C. Johnson & Son, Inc.**, Racine, WI (US)

(**) Term: **15 Years**

(21) Appl. No.: **29/648,757**

(22) Filed: **May 23, 2018**

(51) **LOC (12) Cl.** **09-05**

(52) **U.S. Cl.**
USPC **D9/707**

(58) **Field of Classification Search**
USPC D9/702-714, 414-416, 428, 421, D9/424-426, 430-432, 759; D28/4-8, D28/8.1-8.2
CPC C11D 17/0065-17/0091; C11D 17/00-17/0039; C11D 17/04-17/047
See application file for complete search history.

(56) **References Cited**

U.S. PATENT DOCUMENTS

D821,029 S * 6/2018 Crivolio D28/8.1
D825,847 S * 8/2018 Wissmann D28/8.1

D829,984 S * 10/2018 Gerhards D28/8.1
D833,068 S * 11/2018 Sunder D28/8.1
D838,038 S * 1/2019 Tarnowsky D28/8.1
D841,237 S * 2/2019 Eggemeyer D28/8.1

* cited by examiner

Primary Examiner — Abraham Bahta

(57) **CLAIM**

The ornamental design for a pouch and cleaning composition, as shown and described.

DESCRIPTION

FIG. 1 is a top, front, right perspective view of a pouch and cleaning composition showing our new design;

FIG. 2 is a top view thereof;

FIG. 3 is a bottom view thereof;

FIG. 4 is a rear view thereof;

FIG. 5 is a front view thereof;

FIG. 6 is a left side view thereof;

FIG. 7 is a right side view thereof;

FIG. 8 is a top, front, right perspective view of a first alternative claimed configuration of a pouch and cleaning composition showing our new design;

FIG. 9 is a top view thereof;

FIG. 10 is a bottom view thereof;

FIG. 11 is a rear view thereof;

FIG. 12 is a front view thereof;

FIG. 13 is a left side view thereof; and,

FIG. 14 is a right side view thereof.

The broken lines immediately adjacent to the shaded area define the bounds of the claimed design and form no part thereof. The broken lines depicting the remainder of the pouch and cleaning composition show features that form no part of the claimed design. The contrast in shading represents a contrast in appearance only and does not represent any particular color, material, texture or finish.

1 Claim, 8 Drawing Sheets

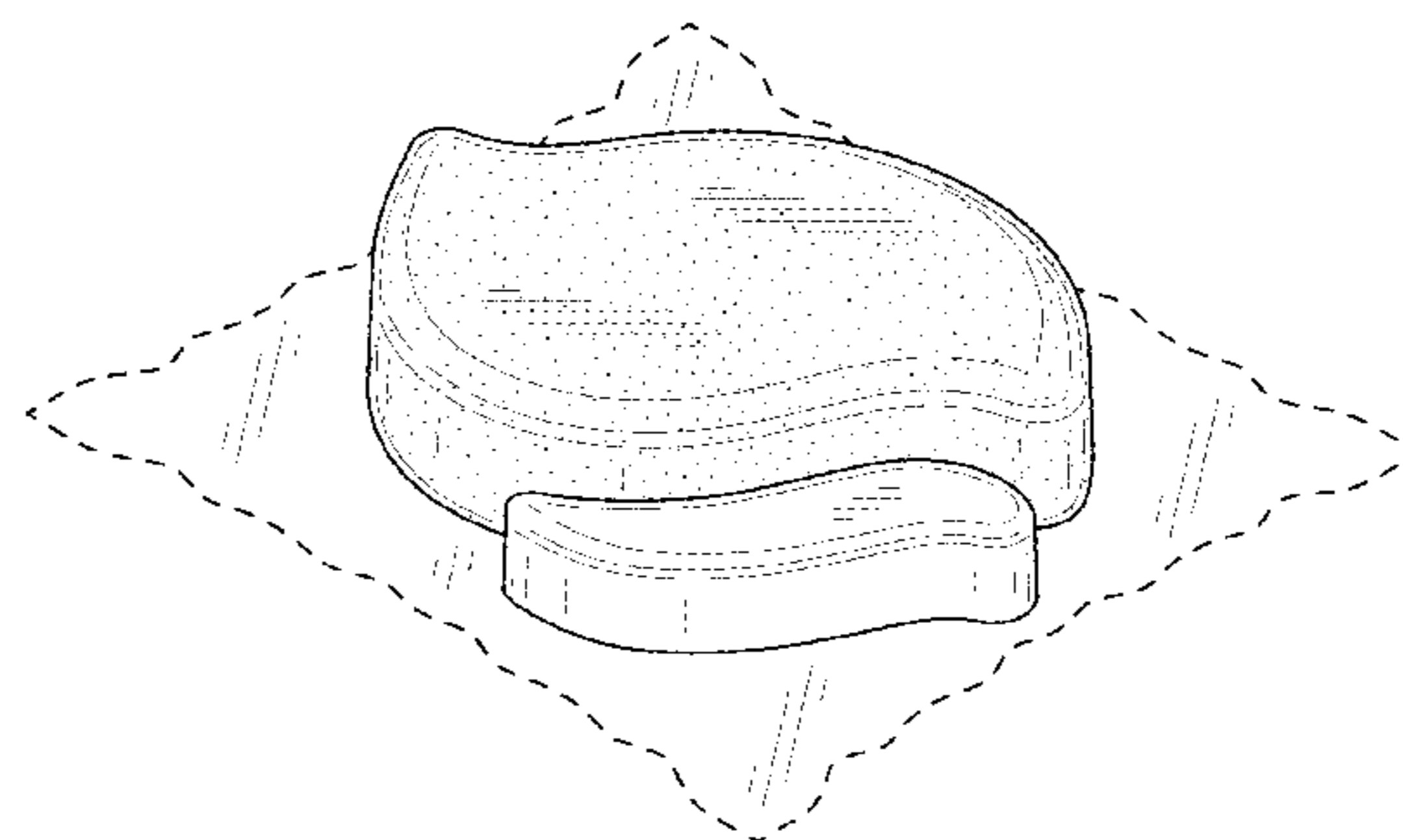
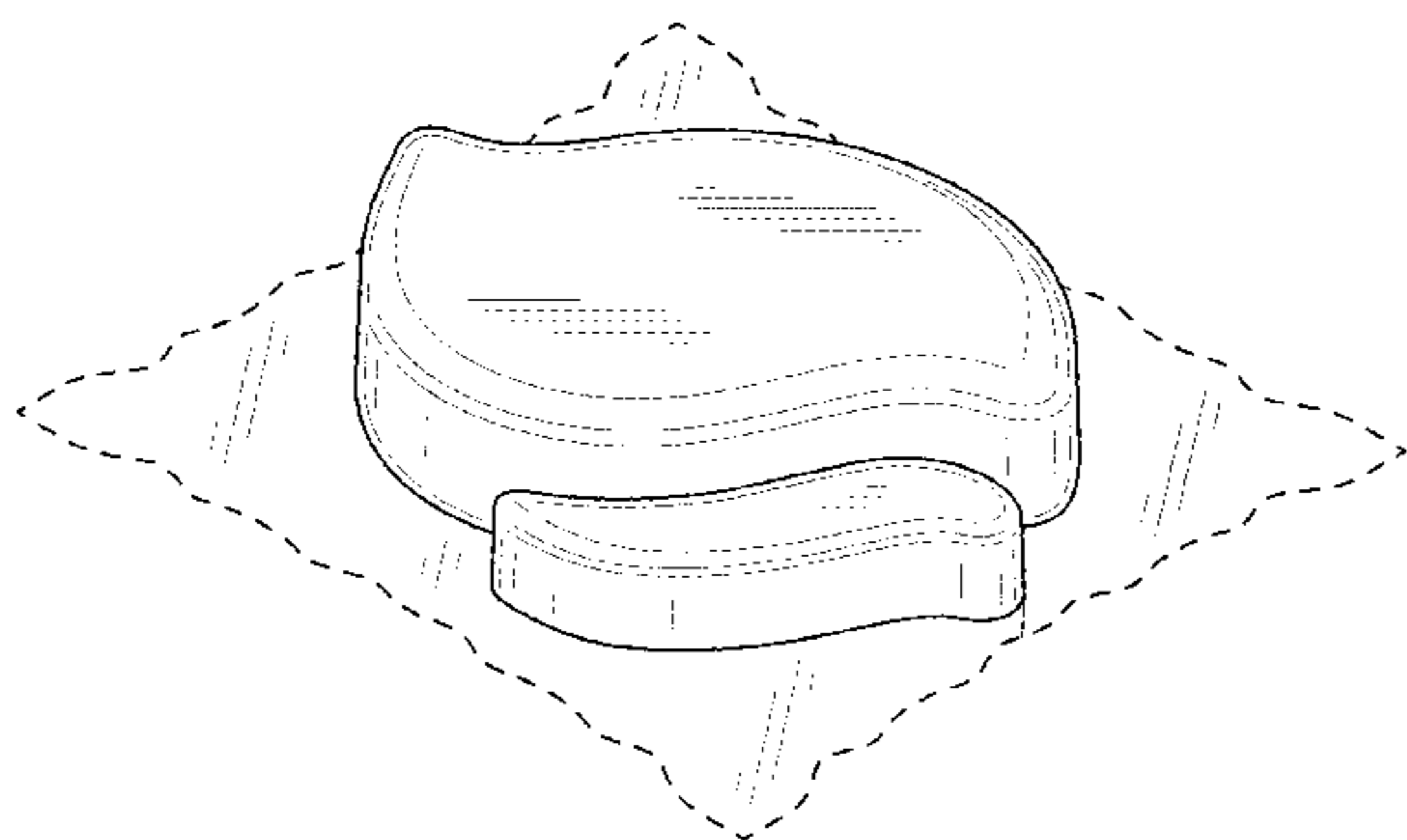

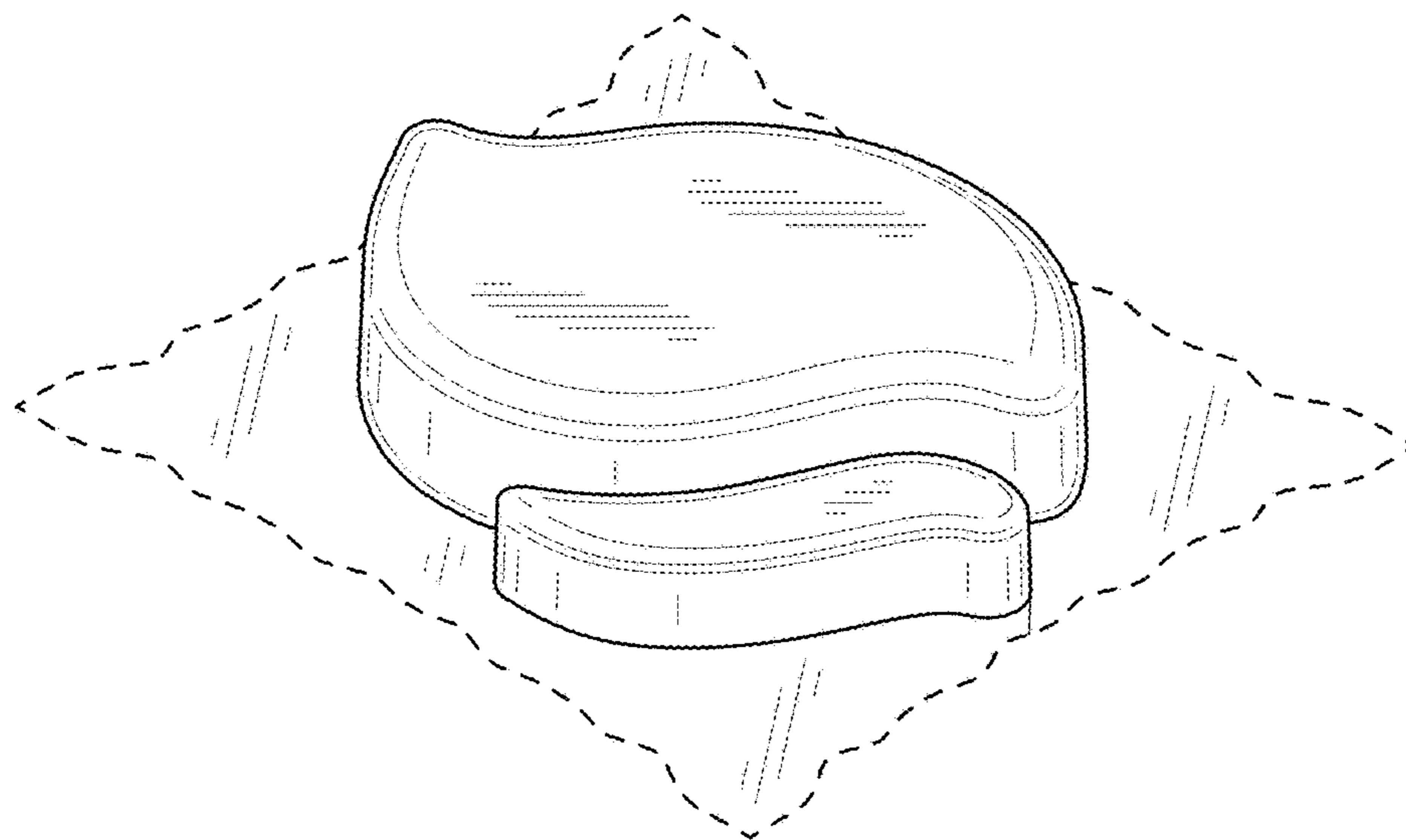

FIG. 1

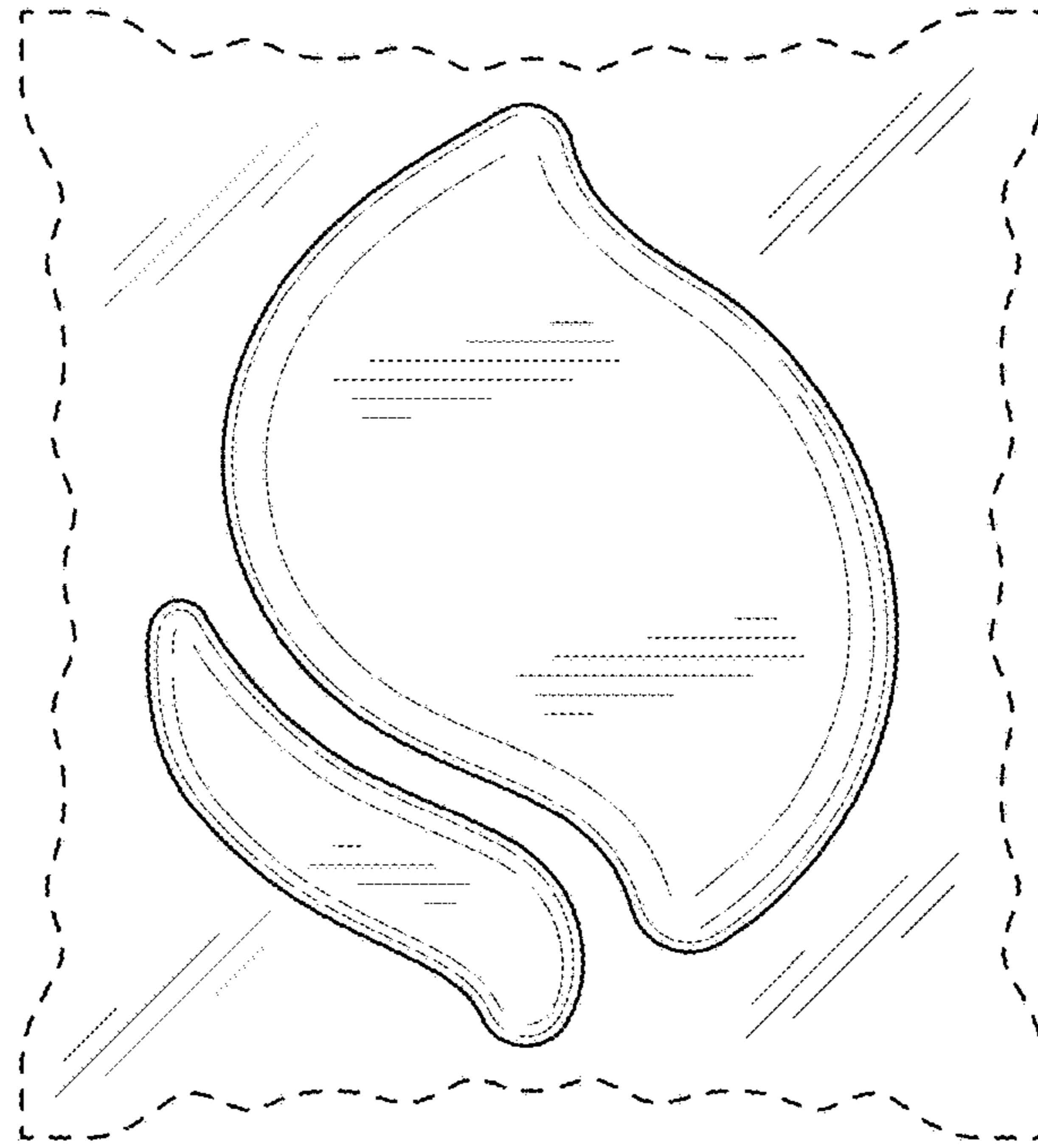

FIG. 2

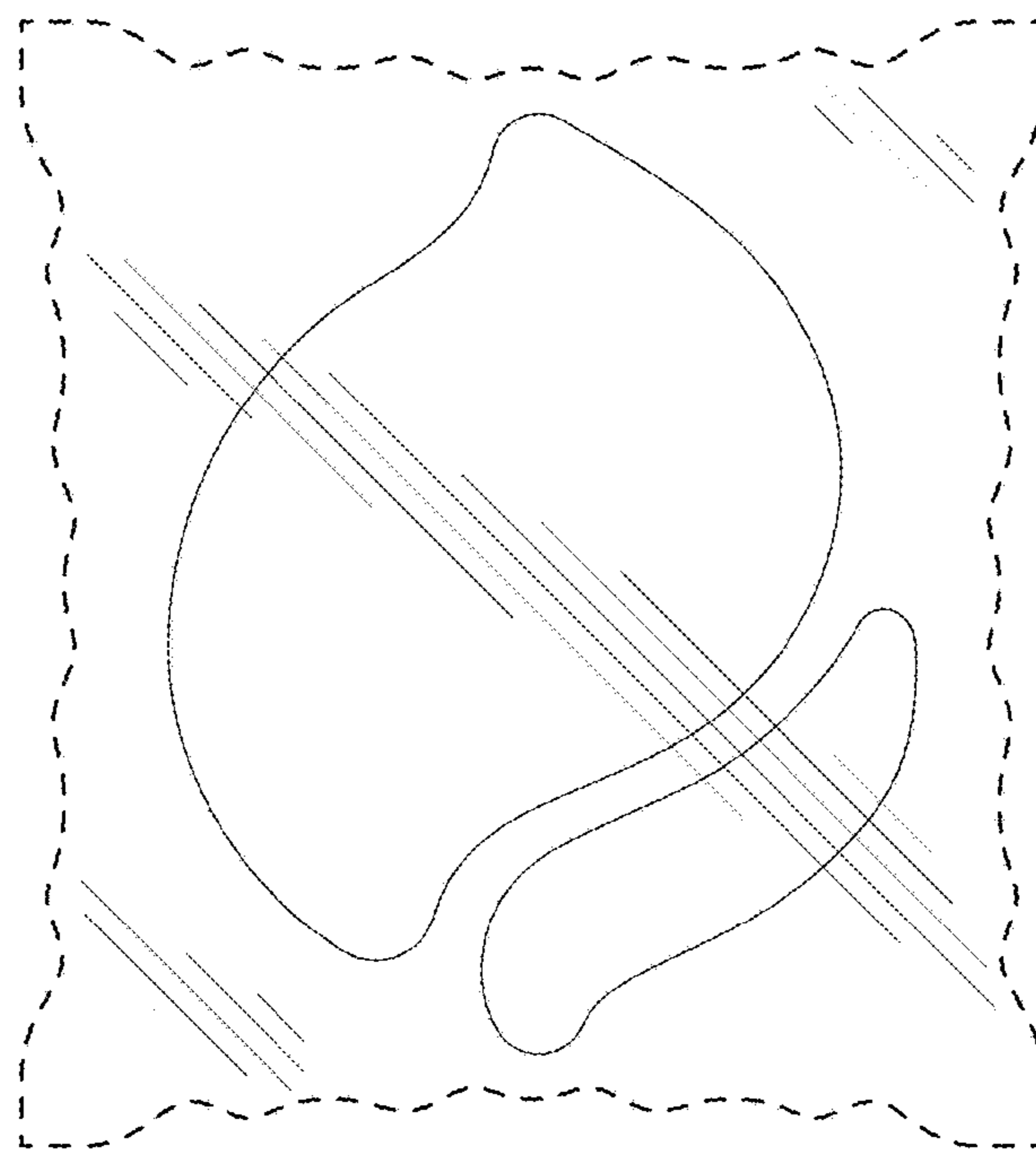

FIG. 3

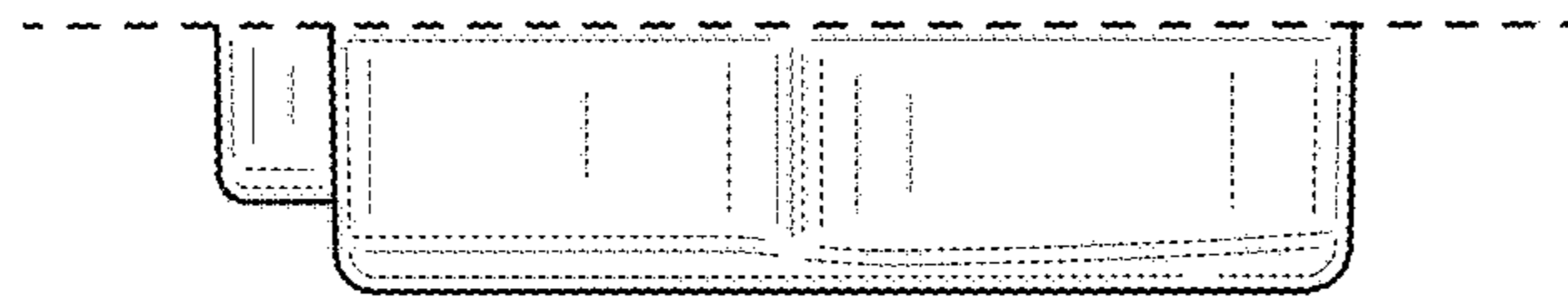

FIG. 4

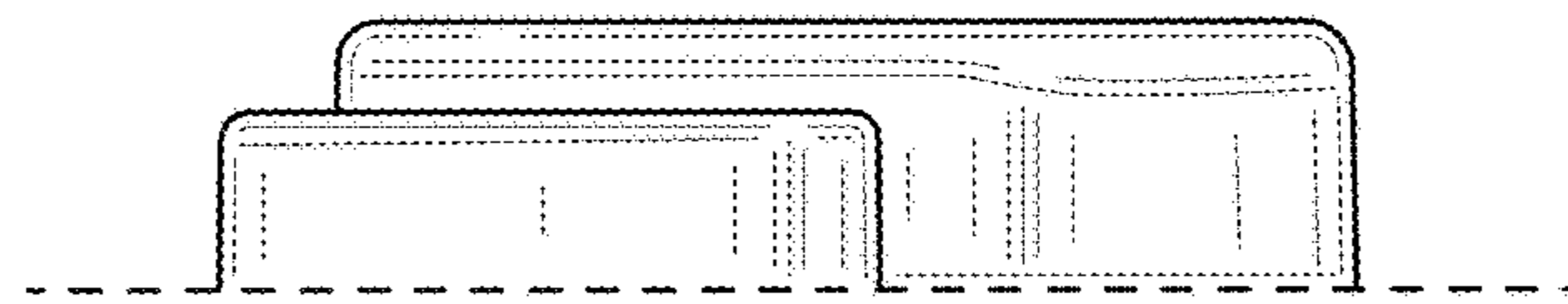

FIG. 5



FIG. 6

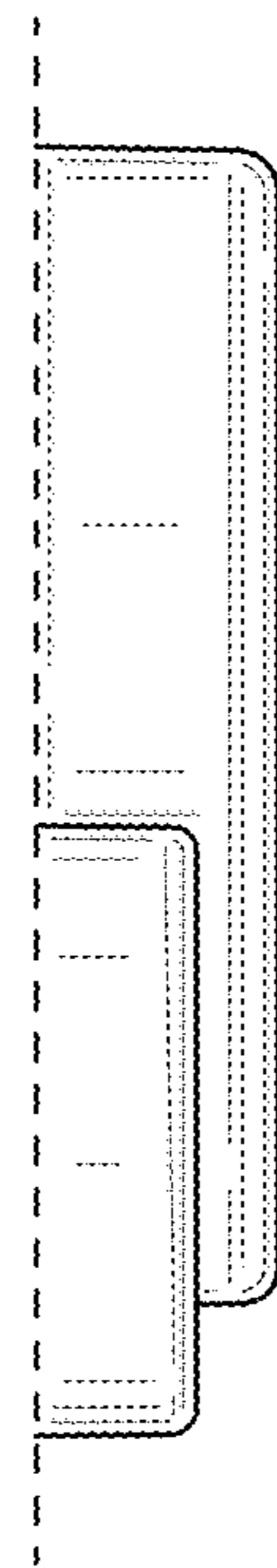

FIG. 7

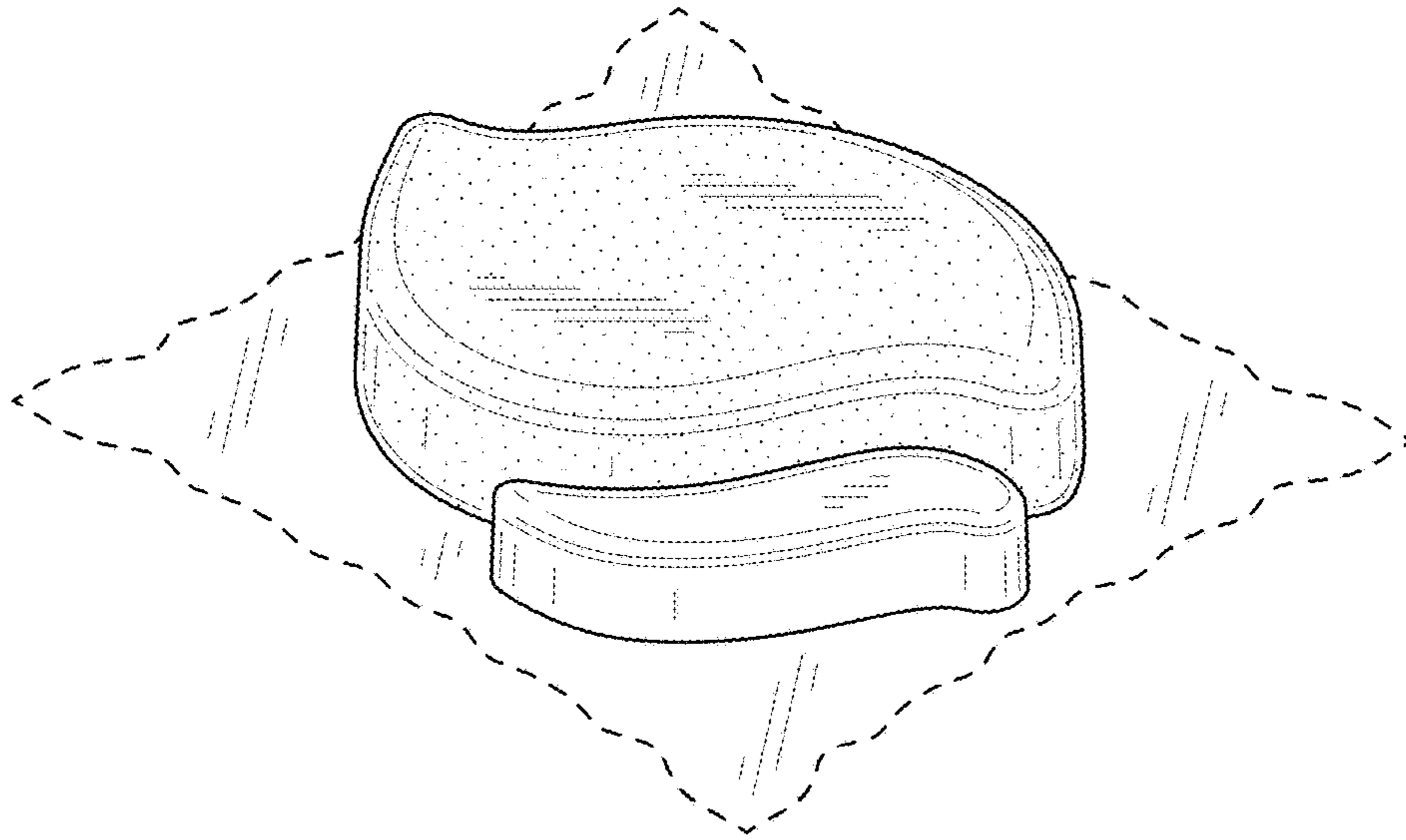

FIG. 8

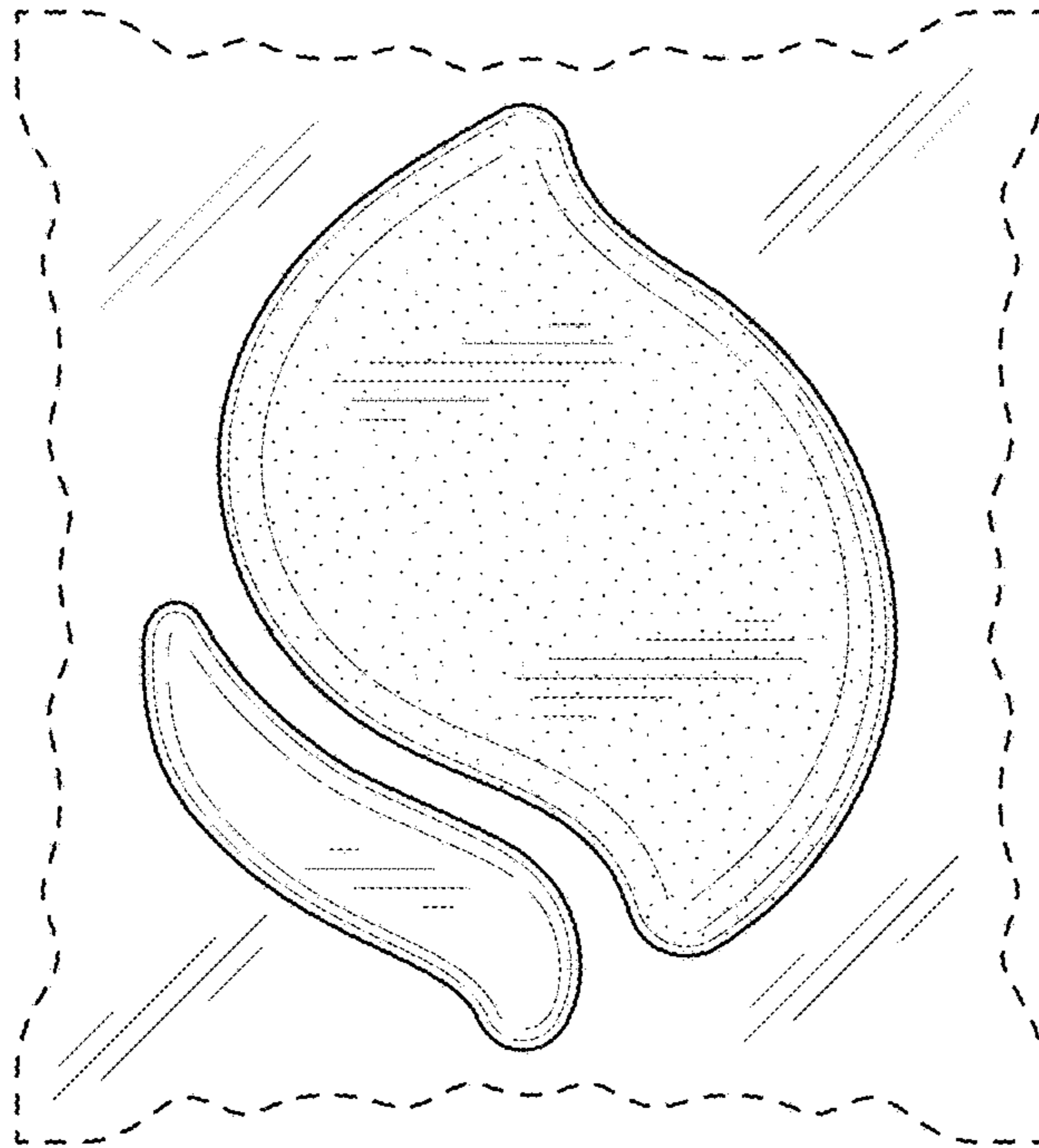

FIG. 9

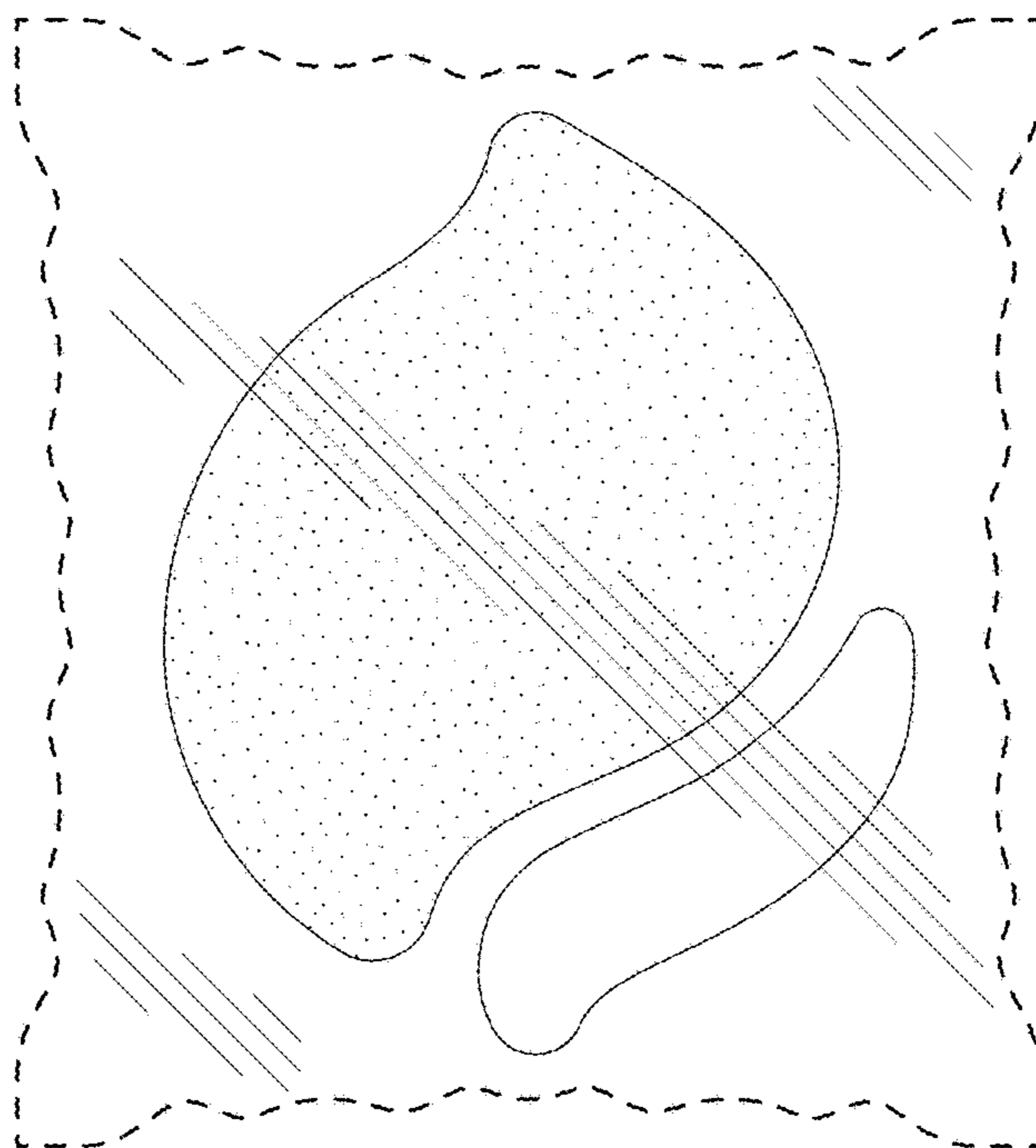

FIG. 10

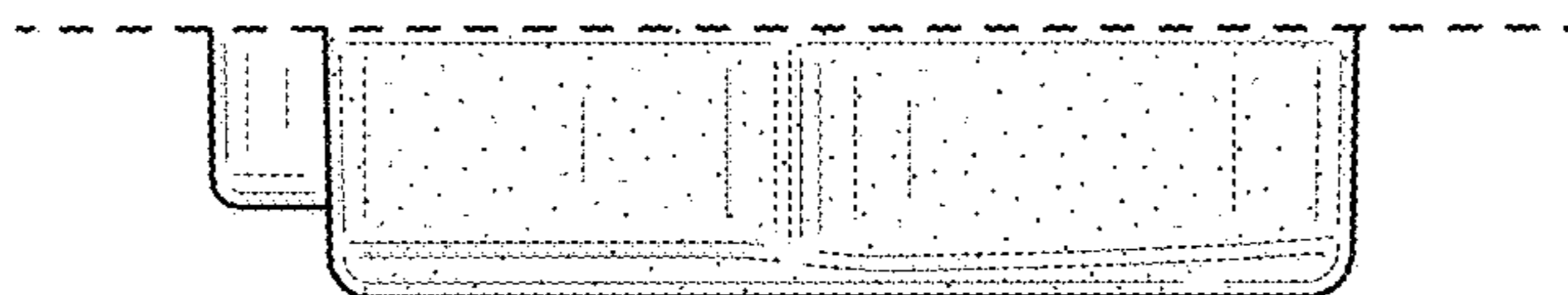

FIG. 11

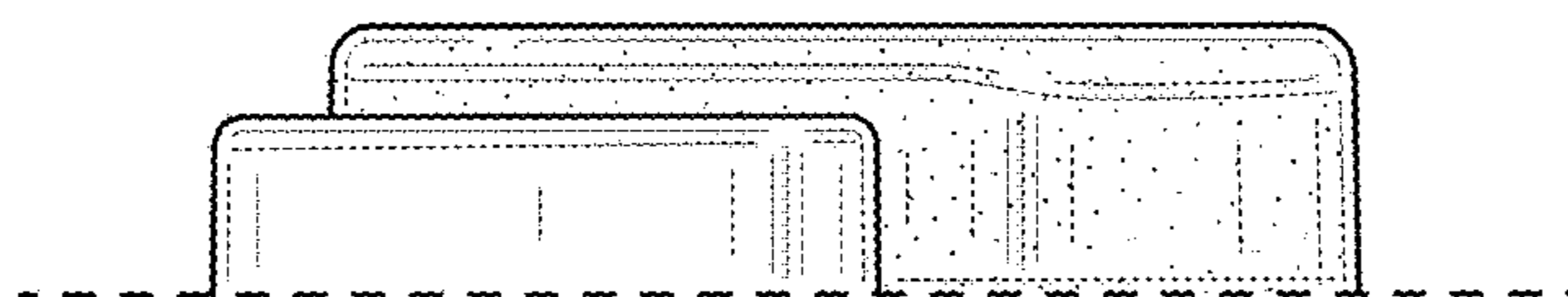

FIG. 12

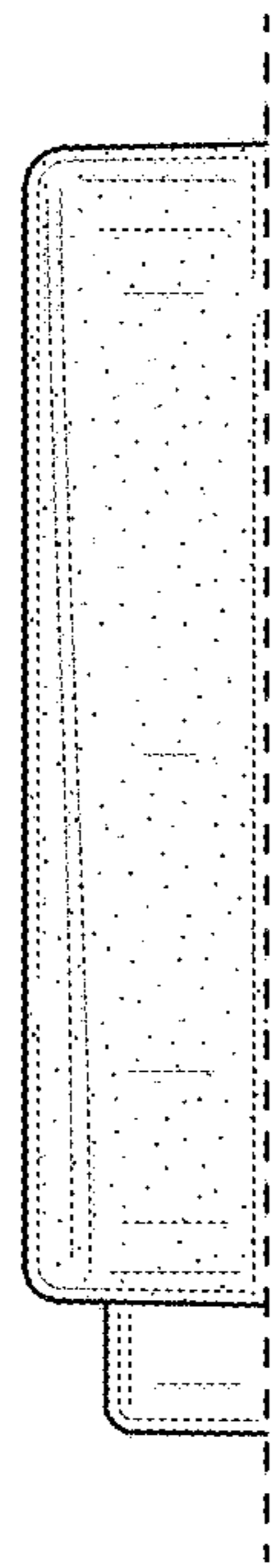

FIG. 13

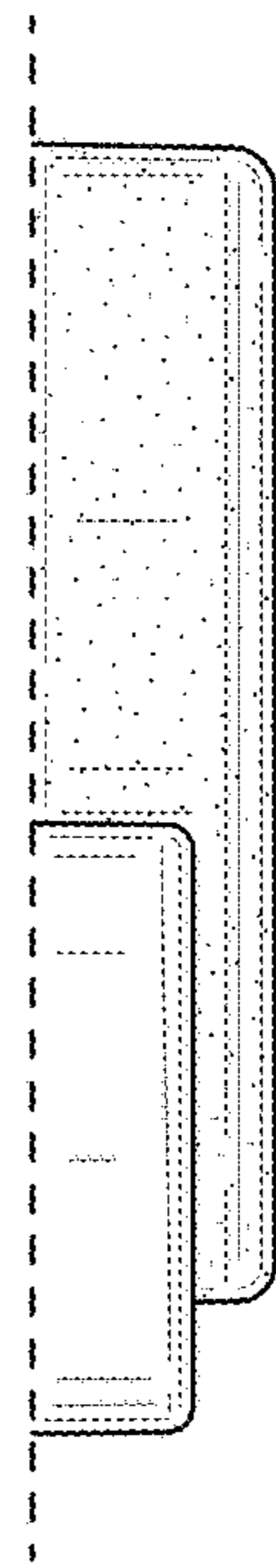

FIG. 14