



US00D857508S

(12) **United States Design Patent**  
**Uetsuki et al.**

(10) **Patent No.:** **US D857,508 S**

(45) **Date of Patent:** **\*\* Aug. 27, 2019**

(54) **CONTAINER**

(71) Applicant: **Kobayashi Pharmaceutical Co., Ltd.**,  
Osaka (JP)

(72) Inventors: **Hidetomo Uetsuki**, Osaka (JP);  
**Tomonori Shinkoda**, Osaka (JP);  
**Satoru Komiyama**, Osaka (JP)

(73) Assignee: **Kobayashi Pharmaceutical Co., Ltd.**  
(JP)

(\*\*) Term: **15 Years**

(21) Appl. No.: **29/633,236**

(22) Filed: **Jan. 12, 2018**

(30) **Foreign Application Priority Data**

Aug. 2, 2017 (AU) ..... 201714565

(51) **LOC (12) Cl.** ..... **09-01**

(52) **U.S. Cl.**  
USPC ..... **D9/526; D9/575**

(58) **Field of Classification Search**  
USPC ..... D9/516, 520, 523, 526, 529, 530, 542,  
D9/549, 550, 571, 575, 715, 719;  
D24/121, 197, 224

CPC ..... B65D 23/102; B65D 83/00; B65D 83/285  
See application file for complete search history.

(56) **References Cited**

**U.S. PATENT DOCUMENTS**

D175,383 S \* 8/1955 Bamberger ..... D9/526  
D257,951 S \* 1/1981 Reichl ..... D9/526  
4,458,820 A \* 7/1984 Abrams ..... B65D 55/024  
215/230  
D308,476 S \* 6/1990 Rosenberg ..... D9/526  
D310,026 S \* 8/1990 Verebelyi ..... D9/520  
D310,960 S \* 10/1990 Verebelyi ..... D9/526  
D321,596 S \* 11/1991 Zierhut ..... D4/114

5,178,308 A \* 1/1993 Endre ..... B62J 11/00  
215/306  
D332,914 S \* 2/1993 Stephens ..... D4/114  
D340,865 S \* 11/1993 Endre ..... D12/114  
D375,049 S \* 10/1996 Vollborth ..... D9/526  
D401,144 S \* 11/1998 Ohara ..... D9/725  
D414,115 S \* 9/1999 Goettner ..... D9/526  
D451,546 S \* 12/2001 Guercio ..... D19/162  
D561,592 S \* 2/2008 Muhlhausen ..... D9/526  
D585,286 S \* 1/2009 Rosinski ..... D9/526  
D633,808 S \* 3/2011 Titherington ..... B65D 50/041  
D9/453  
D636,264 S \* 4/2011 Wassum ..... D9/453  
D696,127 S \* 12/2013 Juna ..... D9/526  
D696,958 S \* 1/2014 Rex ..... D9/435

(Continued)

**FOREIGN PATENT DOCUMENTS**

JP T2000-97943 9/2000

*Primary Examiner* — Ian Simmons

*Assistant Examiner* — Keith Frank

(74) *Attorney, Agent, or Firm* — Saidman DesignLaw  
Group, LLC

(57) **CLAIM**

The ornamental design for a container, as shown and  
described.

**DESCRIPTION**

FIG. 1 is a perspective view of a container showing our new  
design;

FIG. 2 is a second perspective view thereof;

FIG. 3 is a front view thereof;

FIG. 4 is a rear view thereof;

FIG. 5 is a left side view thereof;

FIG. 6 is a right side view thereof;

FIG. 7 is a top view thereof; and,

FIG. 8 is a bottom view thereof.

The broken lines illustrate structure or features which form  
no part of the claimed design.

**1 Claim, 7 Drawing Sheets**

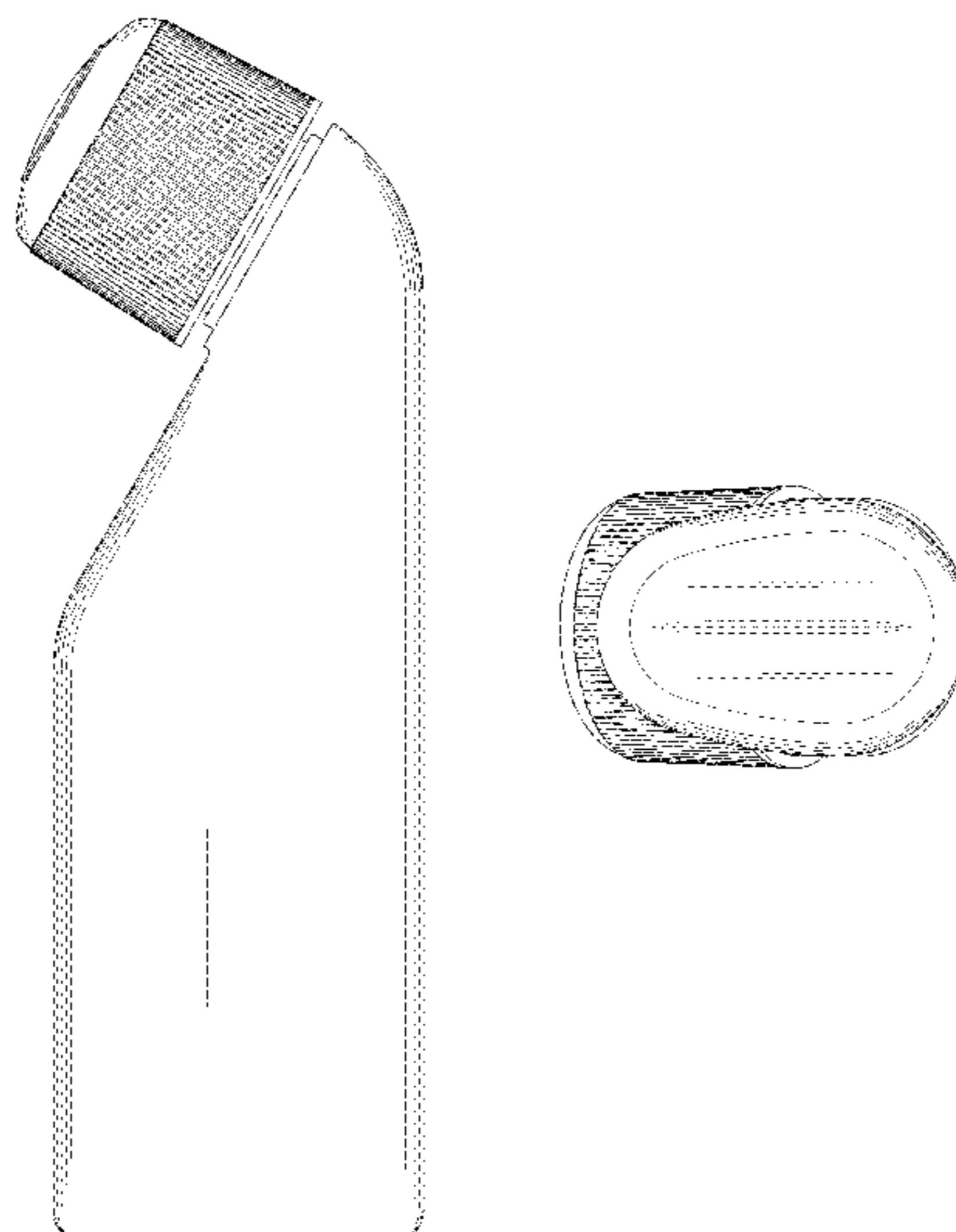

(56)

**References Cited**

U.S. PATENT DOCUMENTS

D731,894 S \* 6/2015 Meyer ..... D9/453  
D768,439 S \* 10/2016 Shin ..... D7/510

\* cited by examiner

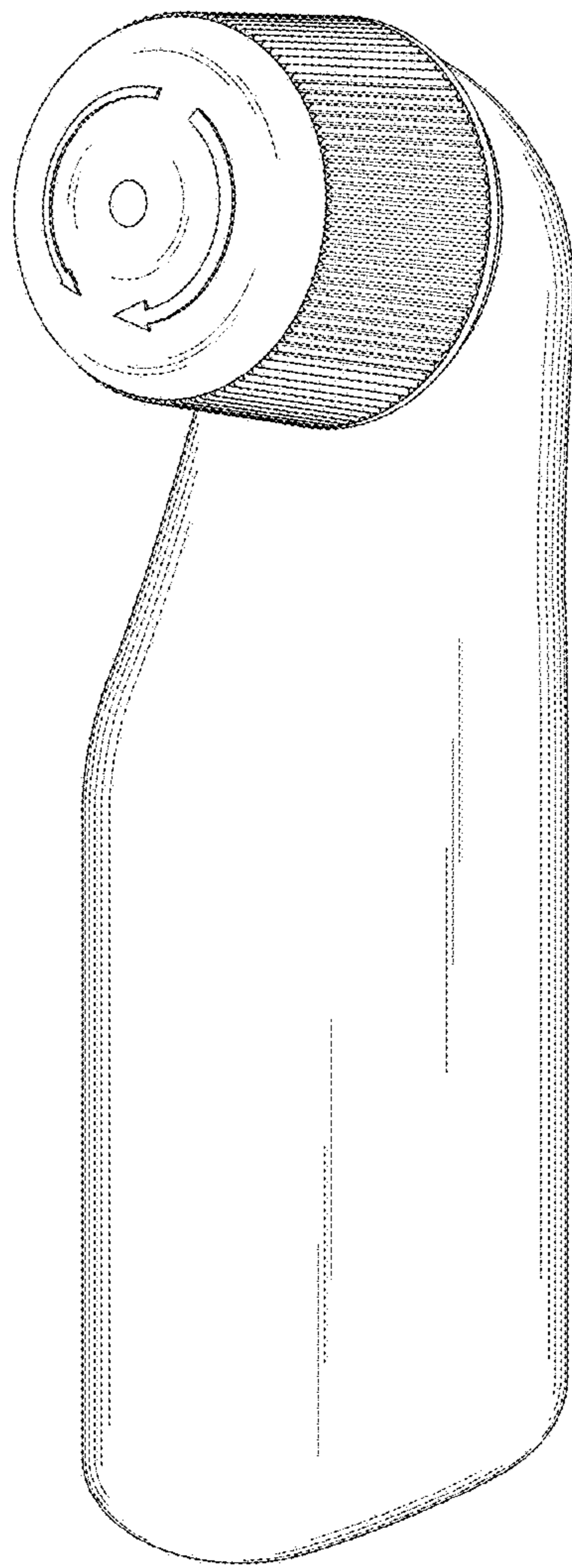

FIG. 1

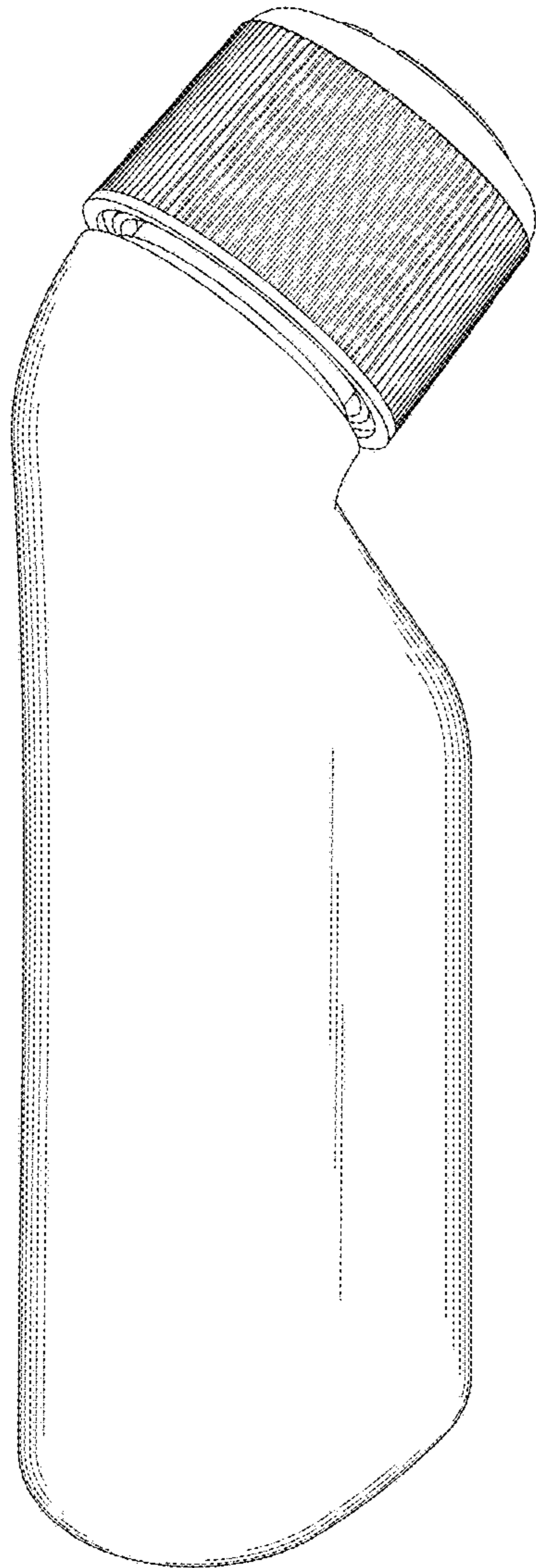

FIG. 2

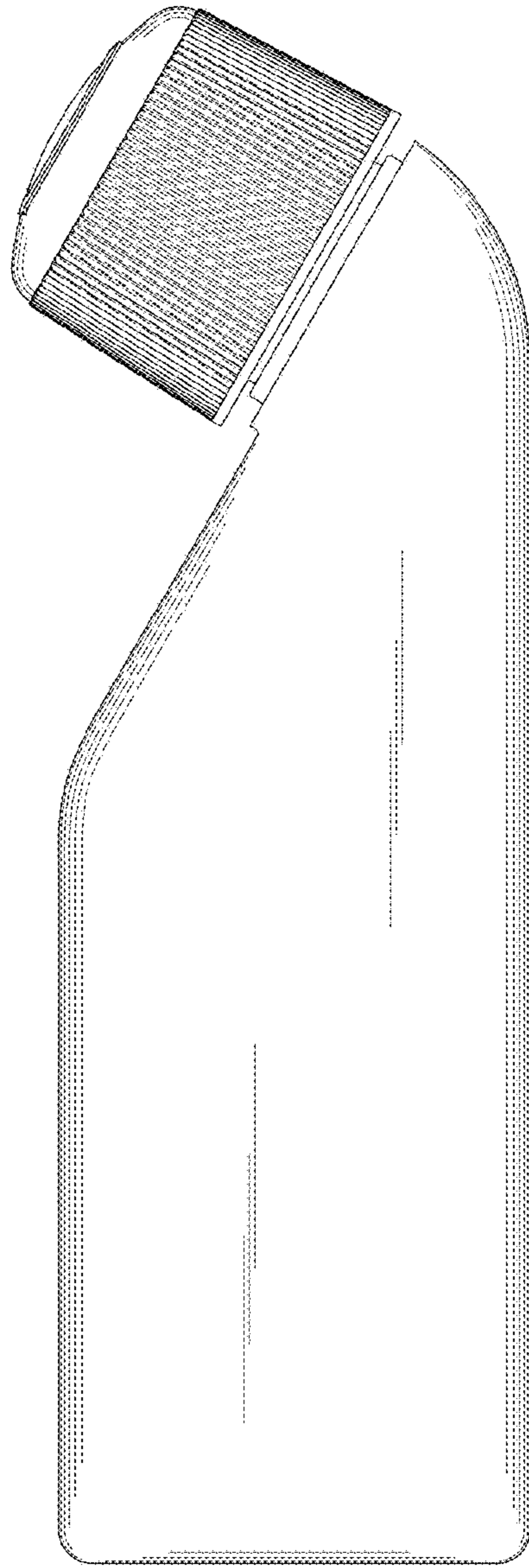

FIG.3



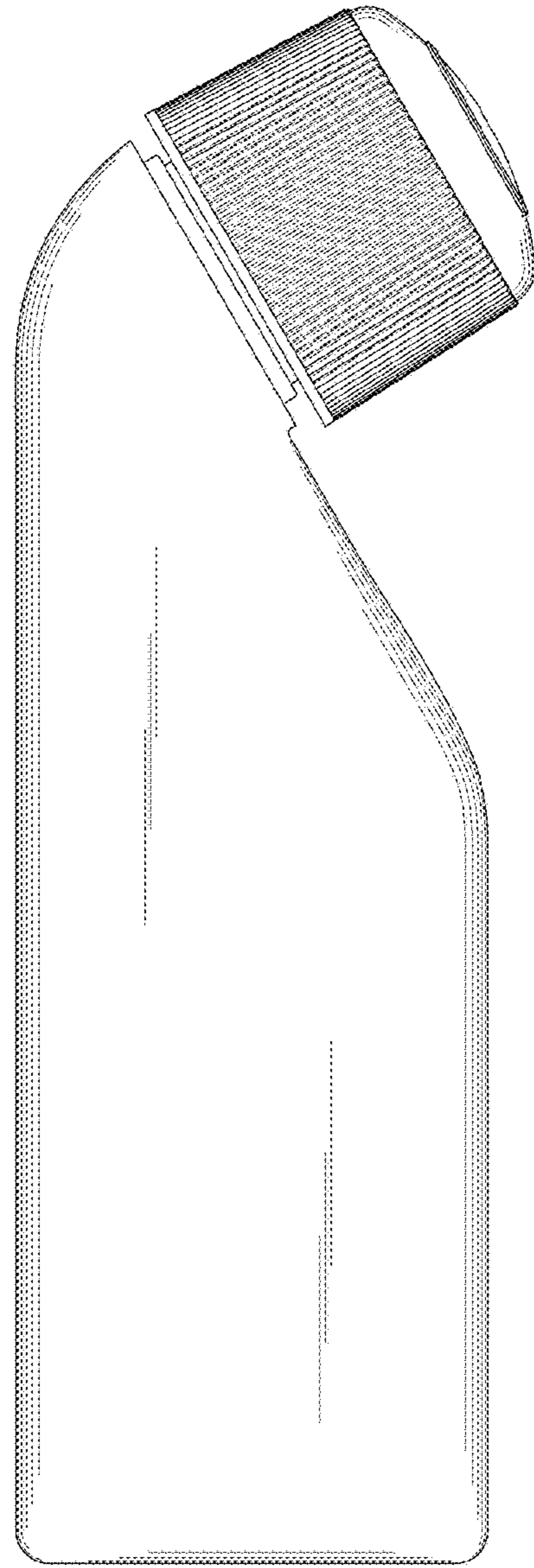

FIG. 4

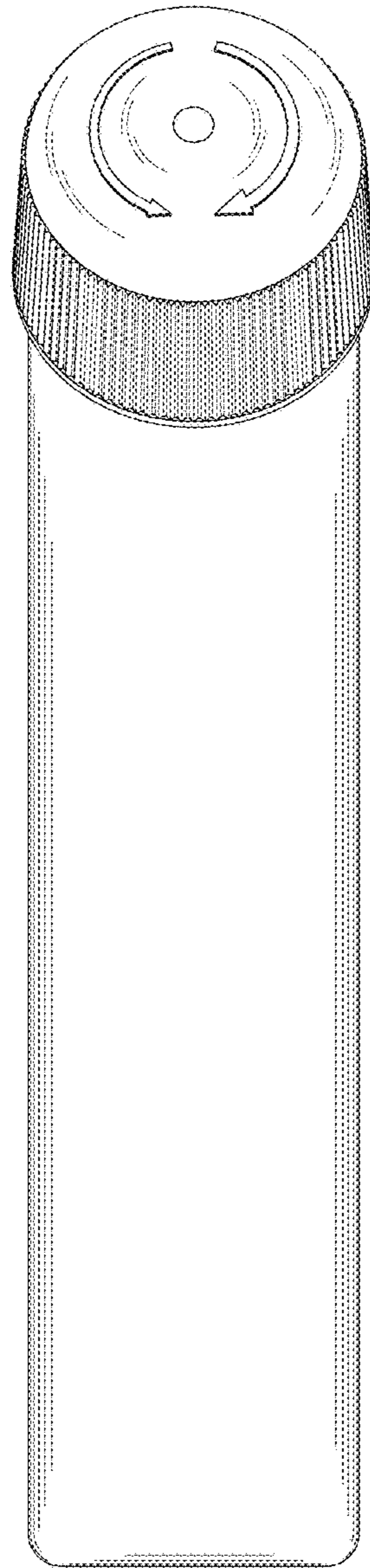

FIG.5

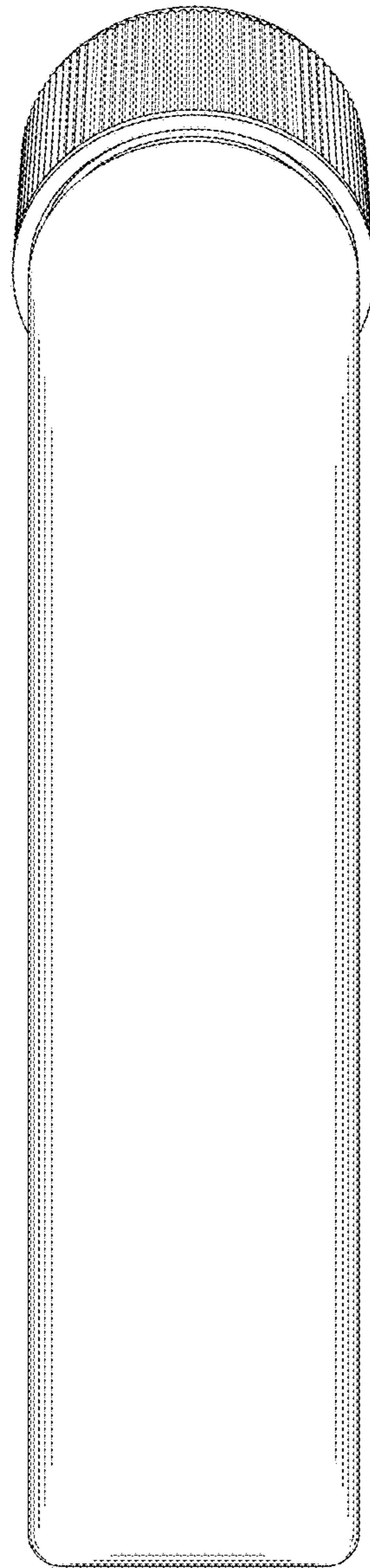

FIG.6



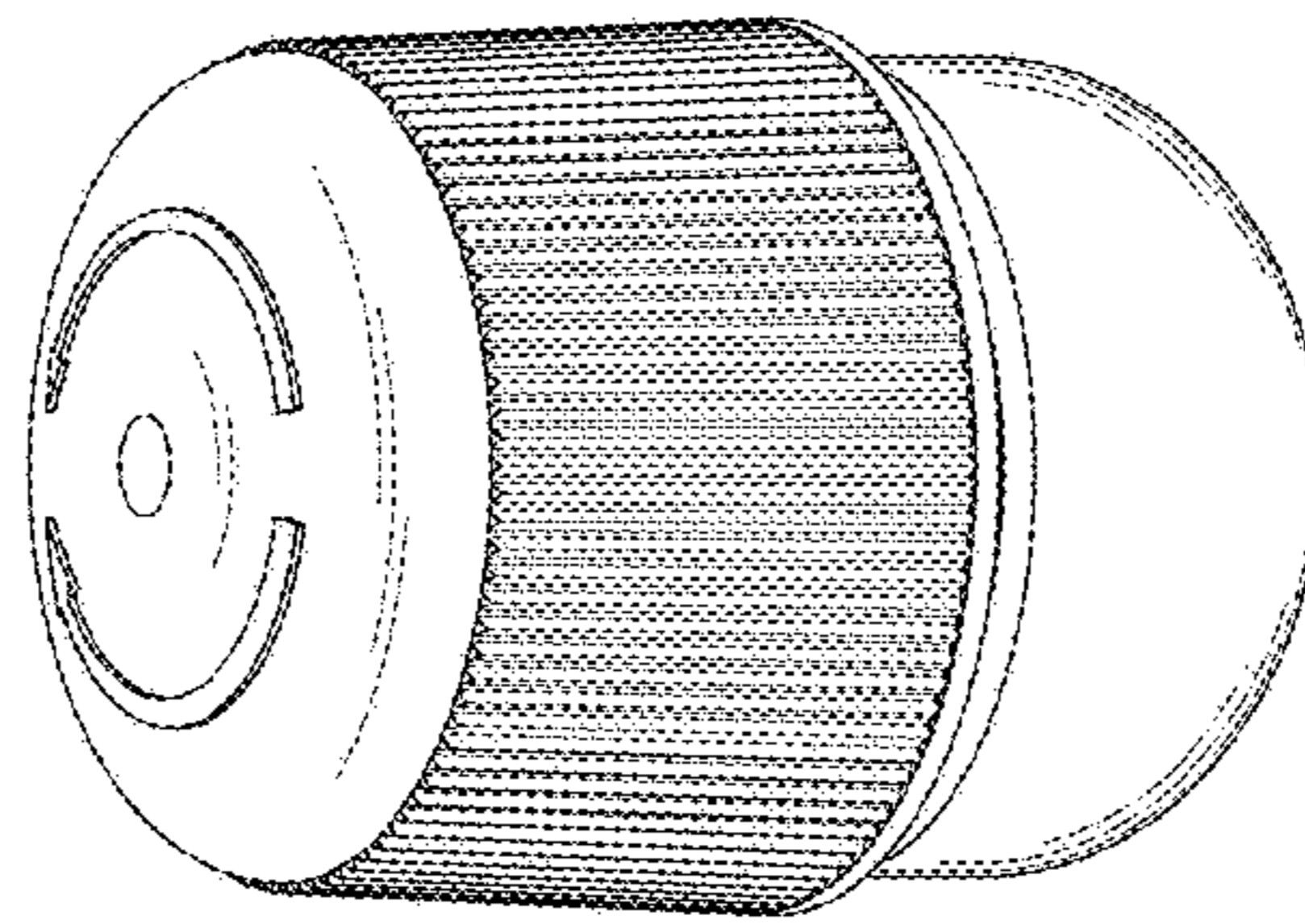

FIG. 7

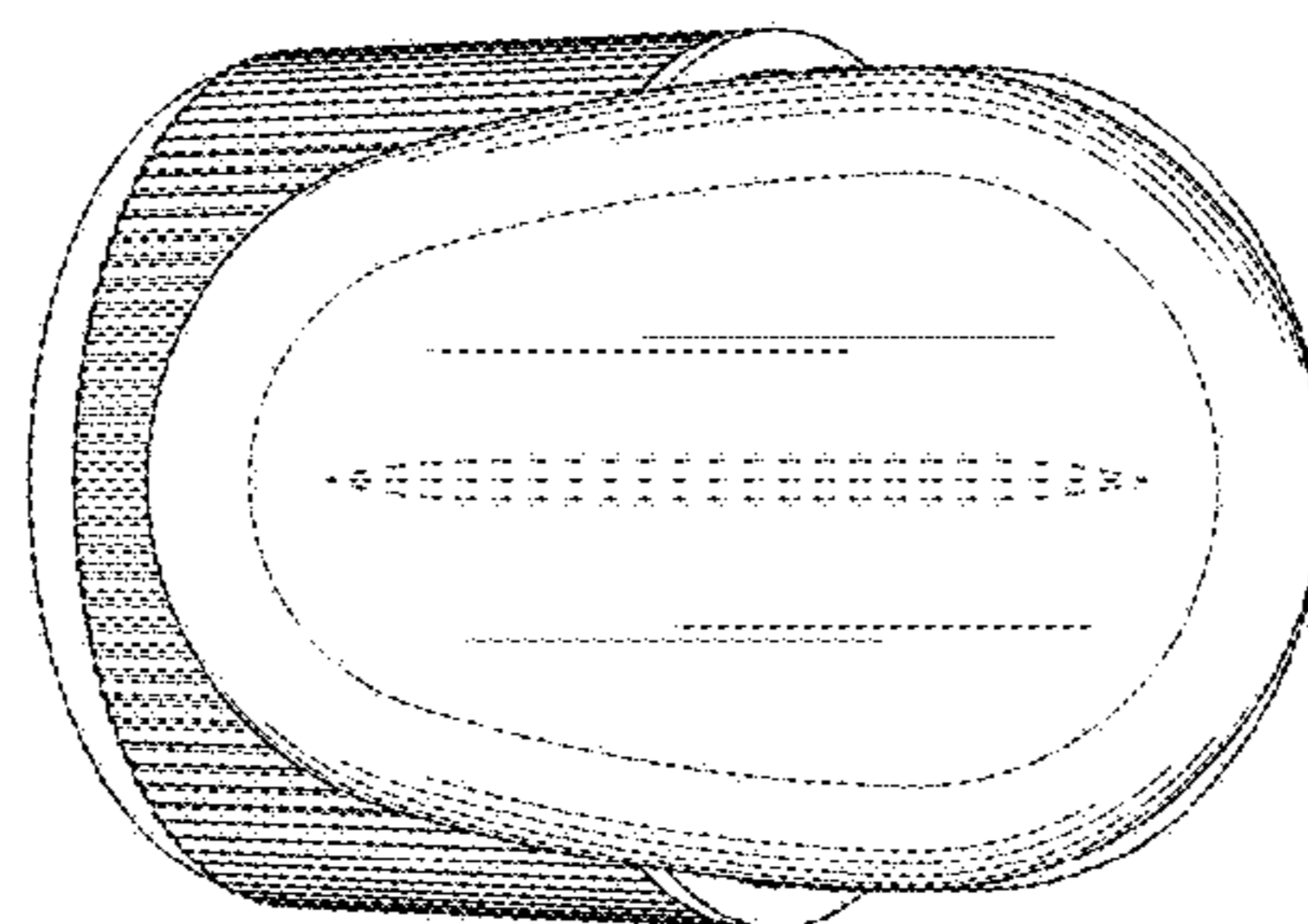

FIG. 8