



US00D857498S

(12) **United States Design Patent** (10) **Patent No.:** **US D857,498 S**  
**Kassler et al.** (45) **Date of Patent:** **\*\* Aug. 27, 2019**

(54) **LID WITH SINGLE SAUCE PACKET RECESS WITH BEVELLED CORNERS**

(71) Applicants: **Aaron Kassler**, Altamonte Springs, FL (US); **Rebecca Kassler**, Altamonte Springs, FL (US)

(72) Inventors: **Aaron Kassler**, Altamonte Springs, FL (US); **Rebecca Kassler**, Altamonte Springs, FL (US)

(\*\*) Term: **15 Years**

(21) Appl. No.: **29/649,456**

(22) Filed: **May 30, 2018**

(51) **LOC (12) Cl.** ..... **09-07**

(52) **U.S. Cl.**  
USPC ..... **D9/436**

(58) **Field of Classification Search**  
USPC ..... D9/414, 416, 425, 434, 435, 436, 438, D9/439, 440, 442, 443, 446-450, D9/452-457, 499, 503-505, 682, 685, D9/686; D7/387, 391, 392, 392.1, 393, D7/394, 396.1-396.4, 401.1, 503-505, D7/509-511, 538, 900; D3/201, 202, D3/203.2, 318; D28/91, 91.1  
CPC .. A61J 1/00; A61J 1/1412; B65D 1/00; B65D 1/02; B65D 1/10; B65D 1/46; B65D 2585/56; B65D 2585/545; B65D 41/00; B65D 41/38; B65D 41/56; B65D 41/62;  
(Continued)

(56) **References Cited**

**U.S. PATENT DOCUMENTS**

D162,024 S \* 2/1951 Goodwin ..... D27/111  
D255,530 S \* 6/1980 Daenen ..... D10/46.3  
(Continued)

**FOREIGN PATENT DOCUMENTS**

CN 105813955 A 7/2016  
KR 20020029004 A 4/2002  
WO WO9826998 A1 6/1998

*Primary Examiner* — Michael A. Pratt  
*Assistant Examiner* — Wendy L Arminio  
(74) *Attorney, Agent, or Firm* — Allen, Dyer, Doppelt + Gilchrist, PA

(57) **CLAIM**

The ornamental design for a lid with single sauce packet recess with bevelled corners, as shown and described.

**DESCRIPTION**

FIG. 1 is a top perspective view of the lid with single sauce packet recess with bevelled corners, according to the present design;  
FIG. 2 is a front side view of the lid with single sauce packet recess with bevelled corners, according to the present design;  
FIG. 3 is a back side view of the lid with single sauce packet recess with bevelled corners, according to the present design;  
FIG. 4 is a right side view of the lid with single sauce packet recess with bevelled corners, according to the present design;  
FIG. 5 is a left side view of the lid with single sauce packet recess with bevelled corners, according to the present design;  
FIG. 6 is a top side view of the lid with single sauce packet recess with bevelled corners, according to the present design; and,  
FIG. 7 is a bottom side view of the lid with single sauce packet recess with bevelled corners, according to the present design.  
The circular broken lines define the boundaries of the claim and along with the spaces contained within them, form no part thereof.  
All other broken lines depict portions of the lid with single sauce packet recess with bevelled corners that form no part of the claimed design.

**1 Claim, 5 Drawing Sheets**

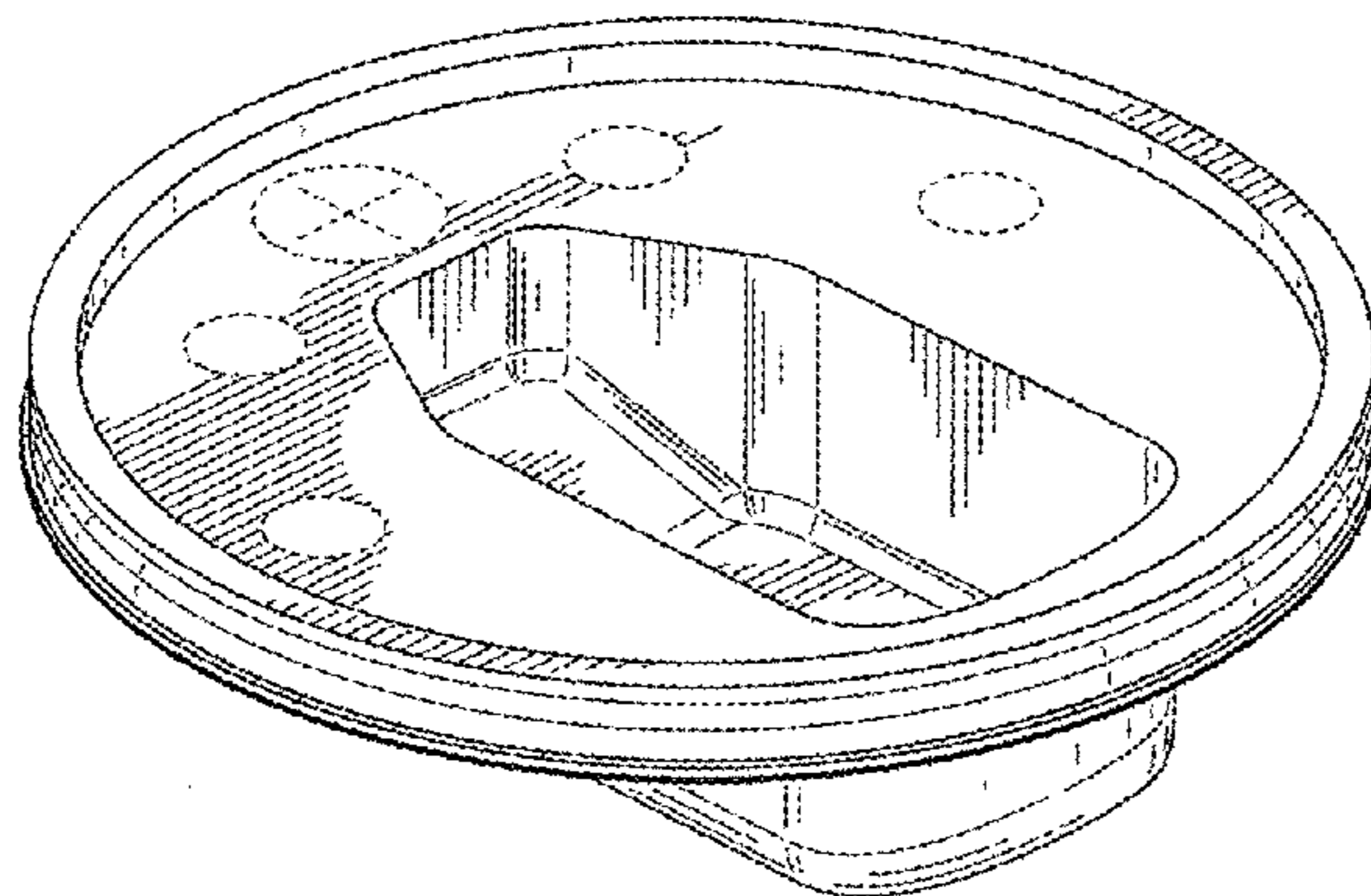

# US D857,498 S

Page 2

(58) **Field of Classification Search**

CPC ..... B65D 47/00; B65D 47/06; B65D 47/08;  
B65D 2543/00046; B65D 2543/00092;  
B65D 2543/00296; B65D 5/46; B65D  
2251/00

See application file for complete search history.

(56) **References Cited**

U.S. PATENT DOCUMENTS

5,722,558 A \* 3/1998 Thompson ..... B65D 51/28  
206/217  
6,209,748 B1 \* 4/2001 Dunbar ..... B65D 51/24  
220/212  
D536,923 S \* 2/2007 Roth ..... D7/392.1  
D556,037 S \* 11/2007 D'Amato ..... D9/454  
D588,002 S \* 3/2009 D'Amato ..... D9/447  
D619,000 S \* 7/2010 Scheve ..... D9/435  
D642,915 S \* 8/2011 Swingle ..... D9/440  
D660,659 S \* 5/2012 Cohen ..... D7/629  
D661,186 S \* 6/2012 Snyder ..... 435/447  
8,231,026 B2 7/2012 White  
D713,248 S \* 9/2014 Kotyuk ..... D9/454

8,973,776 B1 3/2015 Buck  
9,038,845 B1 \* 5/2015 Buck ..... B65D 51/28  
220/521  
D731,313 S \* 6/2015 Kotyuk ..... D9/436  
D731,889 S \* 6/2015 Kotyuk ..... D9/436  
9,181,009 B1 11/2015 Buck  
9,340,333 B2 \* 5/2016 Polt ..... B65D 43/065  
D763,621 S \* 8/2016 Szymanski ..... D7/392.1  
9,751,666 B2 \* 9/2017 Brannock ..... B65D 43/0212  
D807,171 S \* 1/2018 Miller ..... D9/435  
D832,057 S \* 10/2018 Namyst, III ..... D7/602  
D833,212 S \* 11/2018 Buck ..... D7/392.1  
D835,457 S \* 12/2018 Sedgwick ..... D7/392.1  
D835,458 S \* 12/2018 Sedgwick ..... D7/392.1  
D835,459 S \* 12/2018 Sedgwick ..... D7/392.1  
2004/0149755 A1 \* 8/2004 Olivar ..... A47G 19/065  
220/212  
2005/0178766 A1 \* 8/2005 Washington ..... B65D 43/0212  
220/212  
2005/0255201 A1 11/2005 Gruhot et al.  
2007/0090107 A1 4/2007 White  
2014/0030390 A1 1/2014 Coyle et al.  
2014/0042178 A1 2/2014 Brannock  
2015/0144628 A1 5/2015 Piper

\* cited by examiner

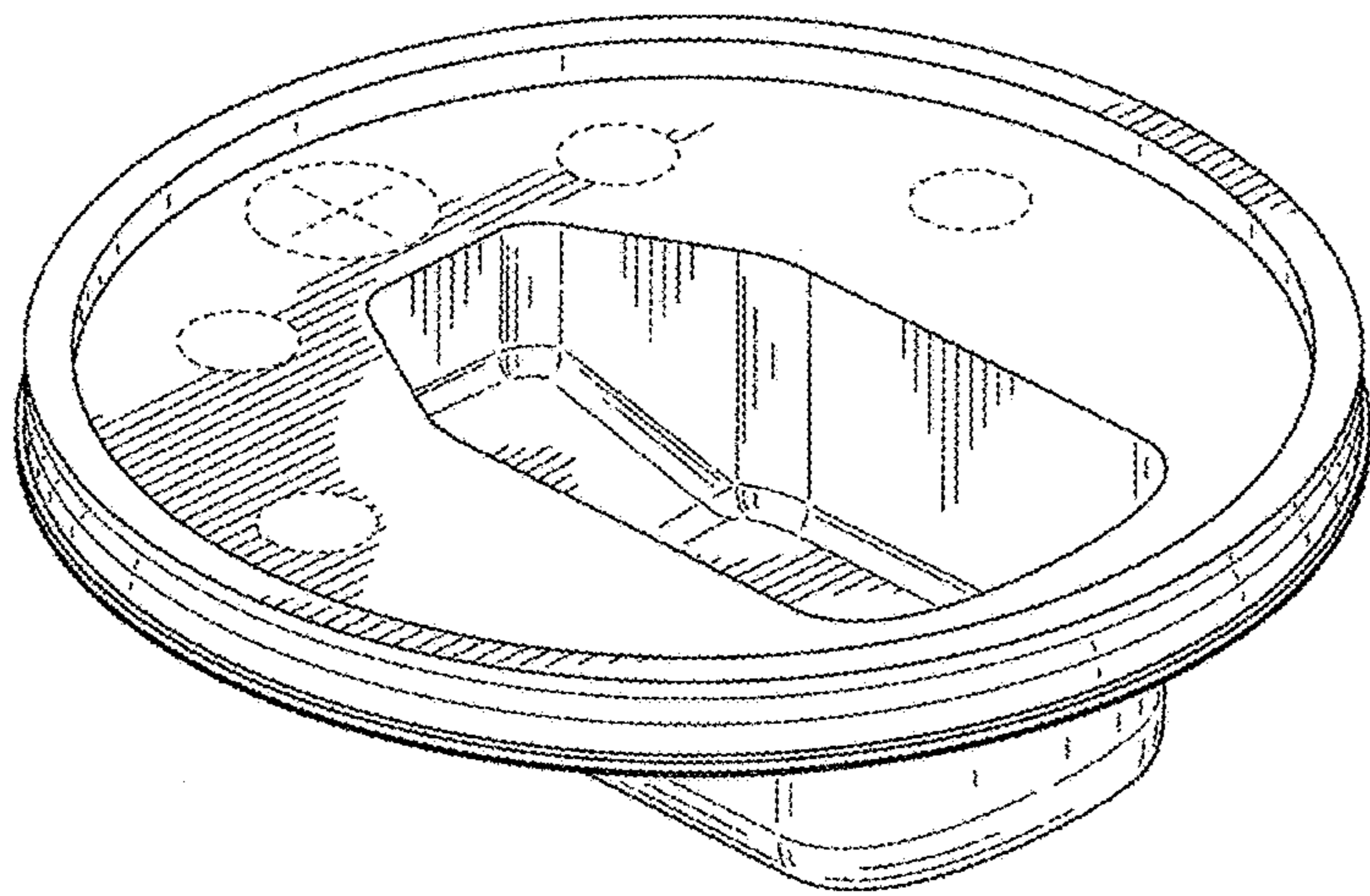

FIG. 1

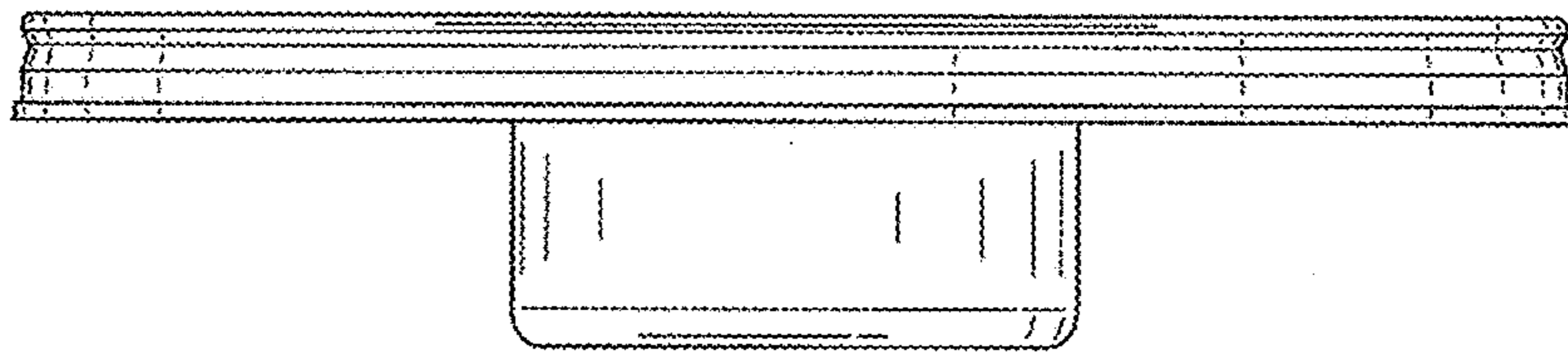

FIG. 2

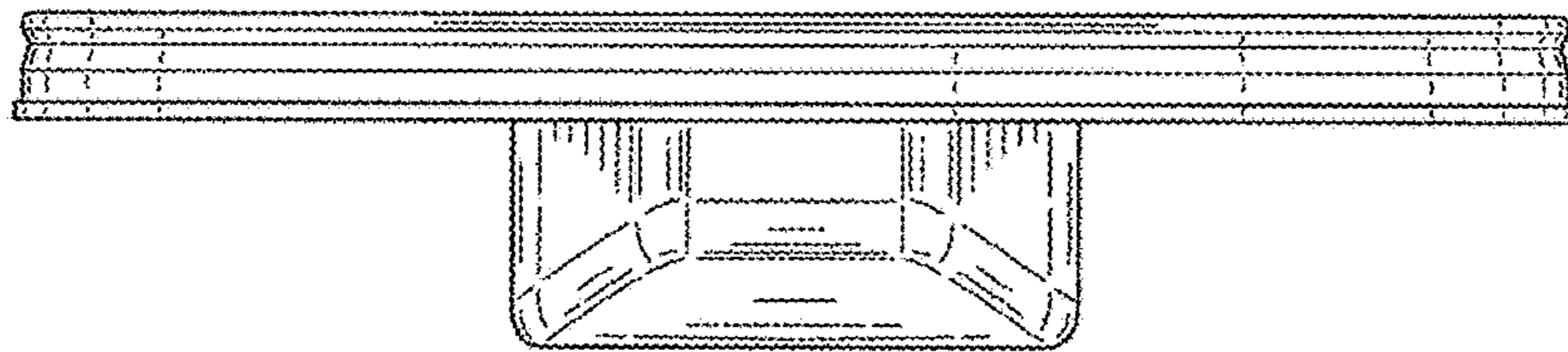

FIG. 3

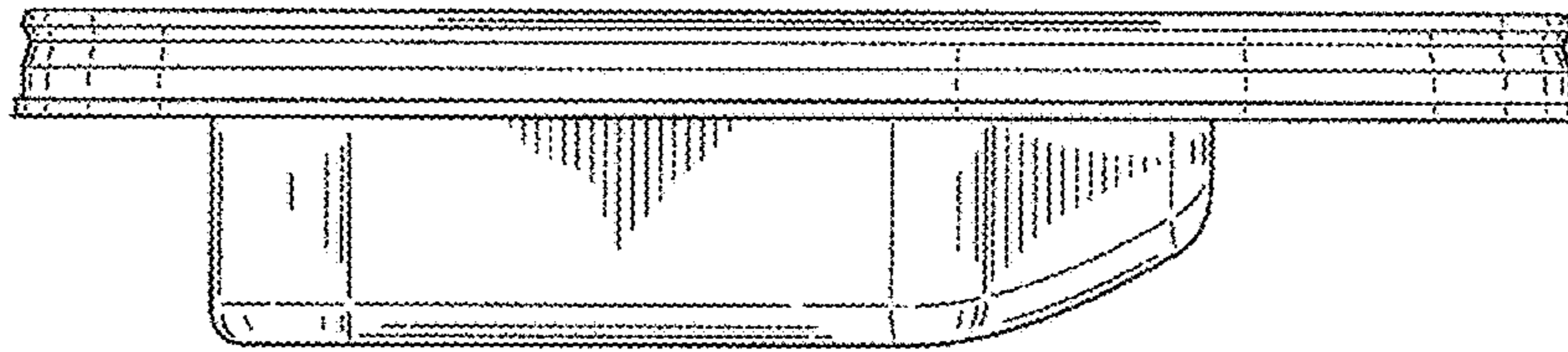

FIG. 4

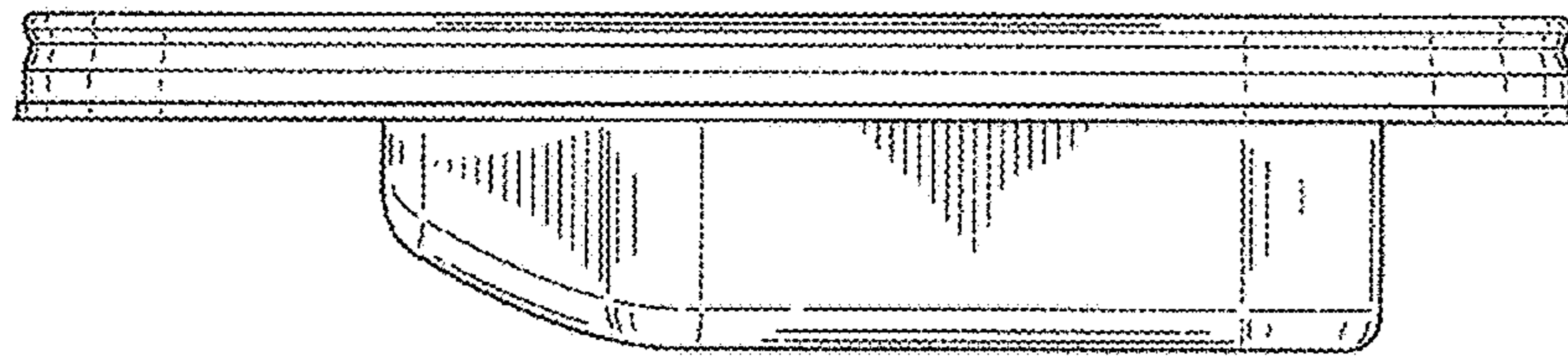

FIG. 5

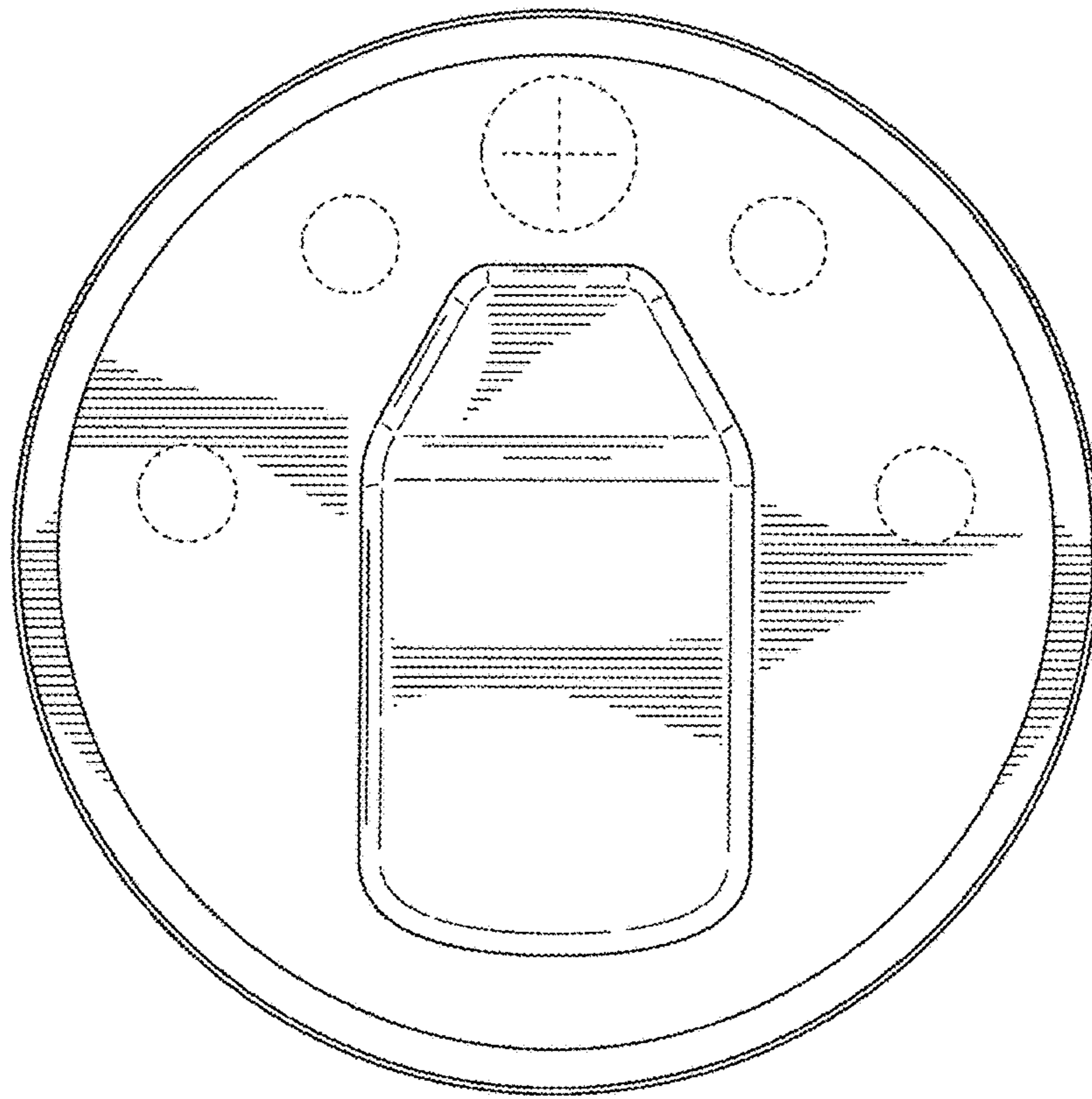

FIG. 6

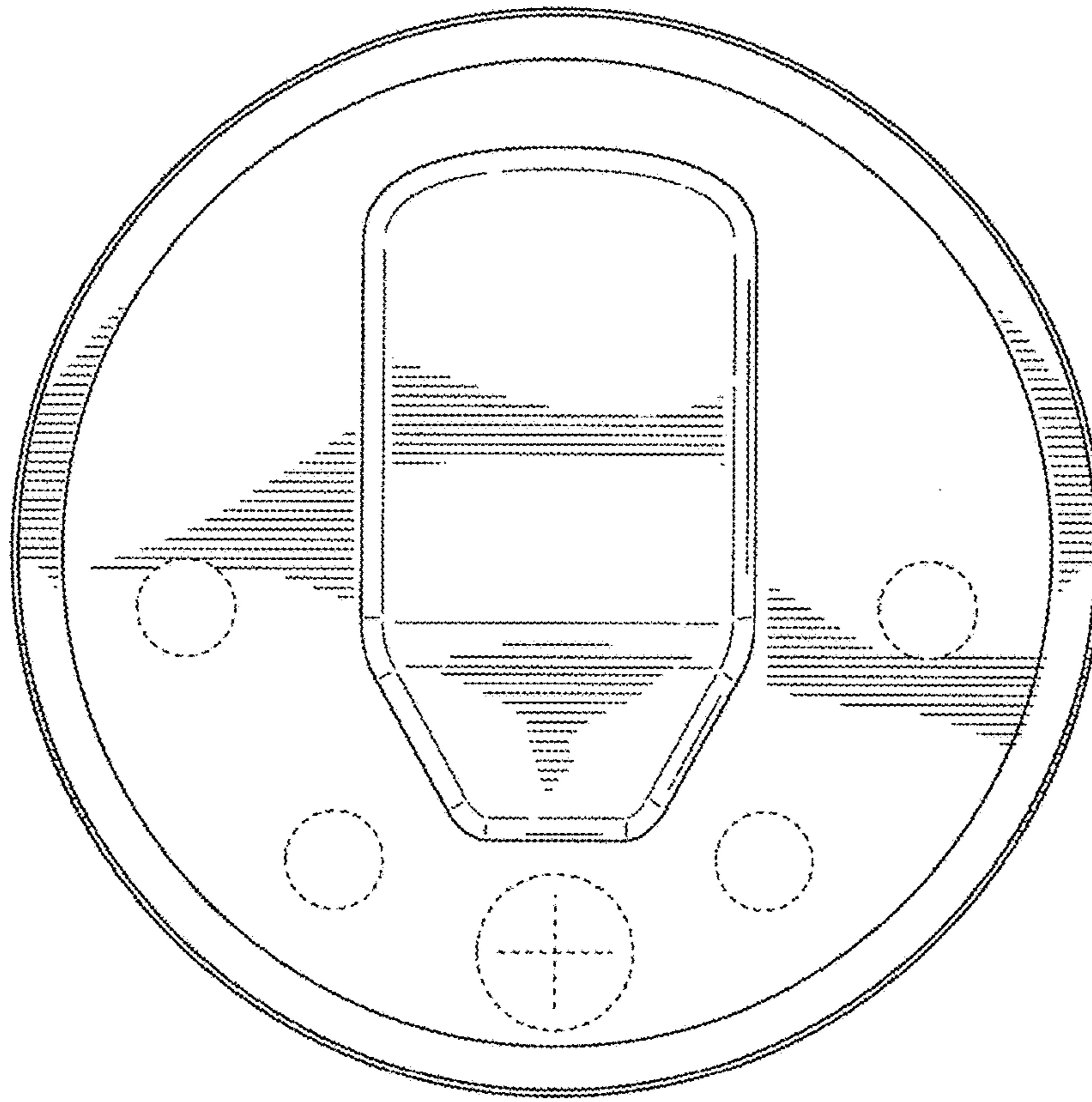

FIG. 7