



US00D857436S

(12) **United States Design Patent** (10) **Patent No.:** **US D857,436 S**
Feiner et al. (45) **Date of Patent:** **** Aug. 27, 2019**

(54) **BACK SUPPORT**
 (71) Applicant: **Gary W. Feiner**, Larkspur, CA (US)
 (72) Inventors: **Gary W. Feiner**, Larkspur, CA (US);
Victor Lazzaro, Fremont, CA (US);
Eugene John Vicknair, Fremont, CA
 (US); **Benjamin John Roth**, Fremont,
 CA (US); **Tom Lin**, Fremont, CA (US)
 (73) Assignee: **Gary W. Feiner**, Larkspur, CA (US)

D731,832 S	6/2015	Feiner	
D774,814 S *	12/2016	Powell	D6/716.4
D779,249 S	2/2017	Cassaday	
D782,239 S	3/2017	Tsai	
D782,240 S	3/2017	Wada	
D793,141 S	8/2017	Igarashi	
D793,143 S *	8/2017	Tsai	D6/716.4
D799,876 S *	10/2017	Pan	D6/716.4
D818,294 S *	5/2018	Tsai	D6/716.4
D827,352 S *	9/2018	Peterson	D6/716.4
D839,035 S *	1/2019	Tsai	D6/716.4

(**) Term: **15 Years**

(21) Appl. No.: **29/617,404**

(22) Filed: **Sep. 13, 2017**

(51) **LOC (12) Cl.** **06-06**

(52) **U.S. Cl.**
USPC **D6/716.4**

(58) **Field of Classification Search**
 USPC ... D6/333-336, 360, 716.1-716.7, 379-380,
 D6/376, 368, 375
 CPC A47C 7/00; A47C 7/02; A47C 7/18; A47C
 7/24; A47C 7/16; A47C 7/282; A47C
 7/285; A47C 7/022; A47C 7/40; A47C
 3/04; A47C 4/02; A47C 4/03; A47C 4/04;
 A47C 5/06; A47C 5/12
 See application file for complete search history.

(56) **References Cited**

U.S. PATENT DOCUMENTS

D226,062 S	1/1973	Corchran et al.
D289,482 S	4/1987	Reddick
D345,259 S	3/1994	Narita
D439,101 S	3/2001	Simons, Jr. et al.
D463,693 S	10/2002	Hsieh
D672,172 S	12/2012	Walker
D683,574 S	6/2013	Su
D724,881 S	3/2015	Tsai

OTHER PUBLICATIONS

Pending Design U.S. Appl. No. 29/570,796, filed Jul. 12, 2016.
 Pending Design U.S. Appl. No. 29/599,401, filed Apr. 3, 2017.

* cited by examiner

Primary Examiner — Abraham Bahta

(74) *Attorney, Agent, or Firm* — Polson Intellectual
Property Law, PC; Margaret Polson

(57) **CLAIM**

The ornamental design for a back support, as shown and described.

DESCRIPTION

FIG. 1 is a front isometric view of the back support showing our new design;
 FIG. 2 is a front side elevation view of FIG. 1.
 FIG. 3 is a back side elevation view of FIG. 1
 FIG. 4 is a top plan view of FIG. 1.
 FIG. 5 is a bottom plan view of FIG. 1.
 FIG. 6 is a left side elevation view of FIG. 1; and,
 FIG. 7 is a right a side elevation view of FIG. 1.
 The features shown in broken lines in the drawing depict environmental subject matter only and form no part of the claimed design.

1 Claim, 4 Drawing Sheets

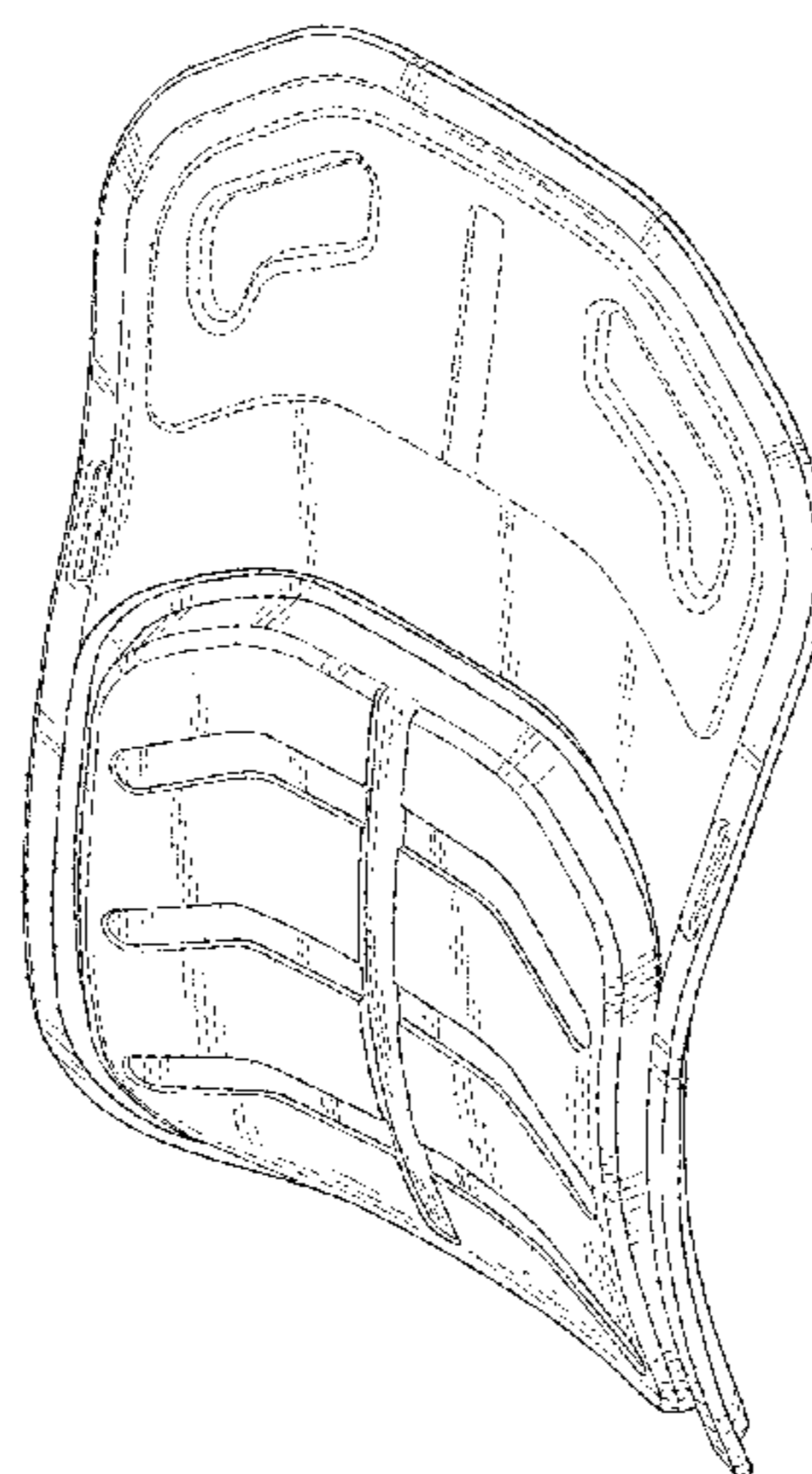

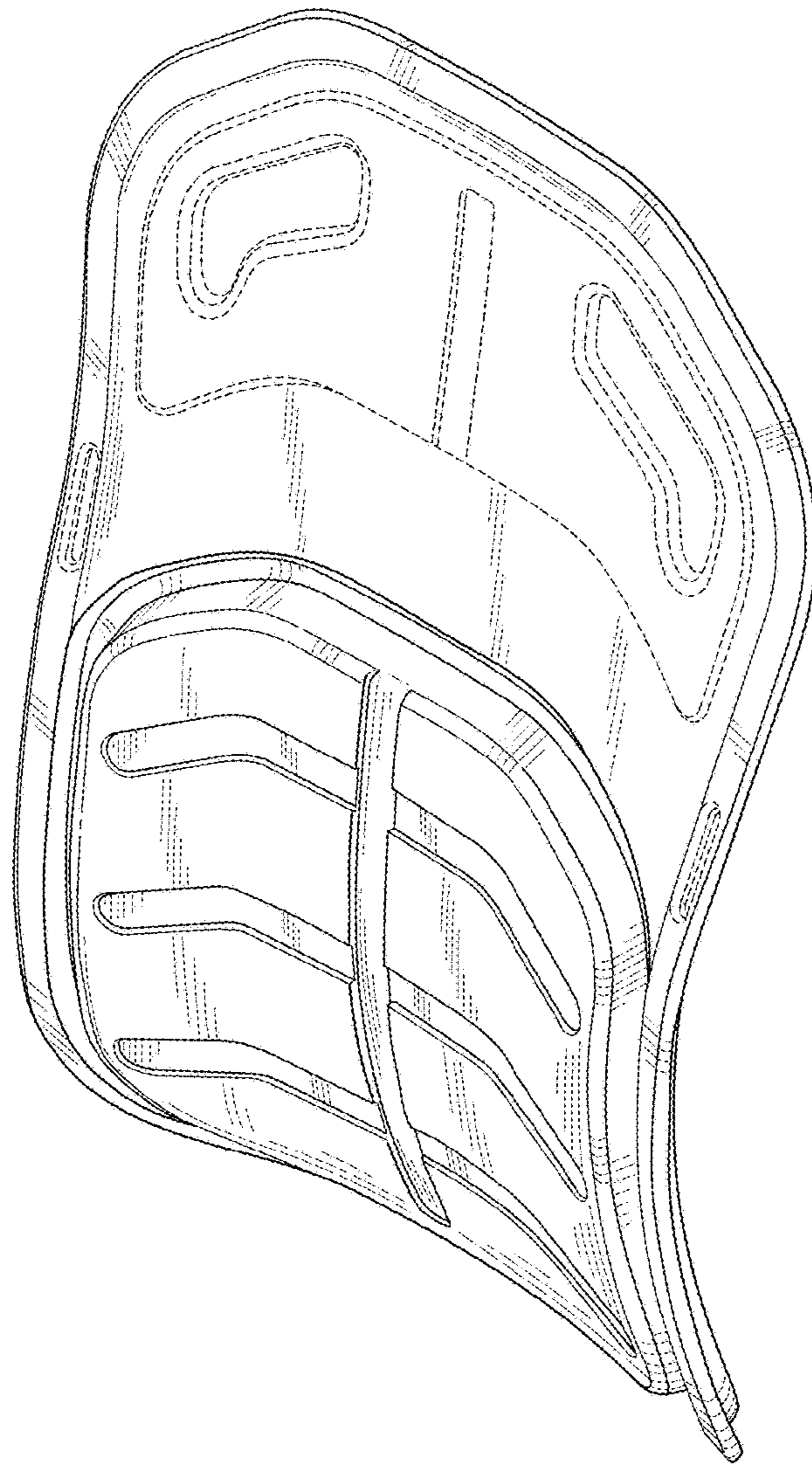

FIG.1

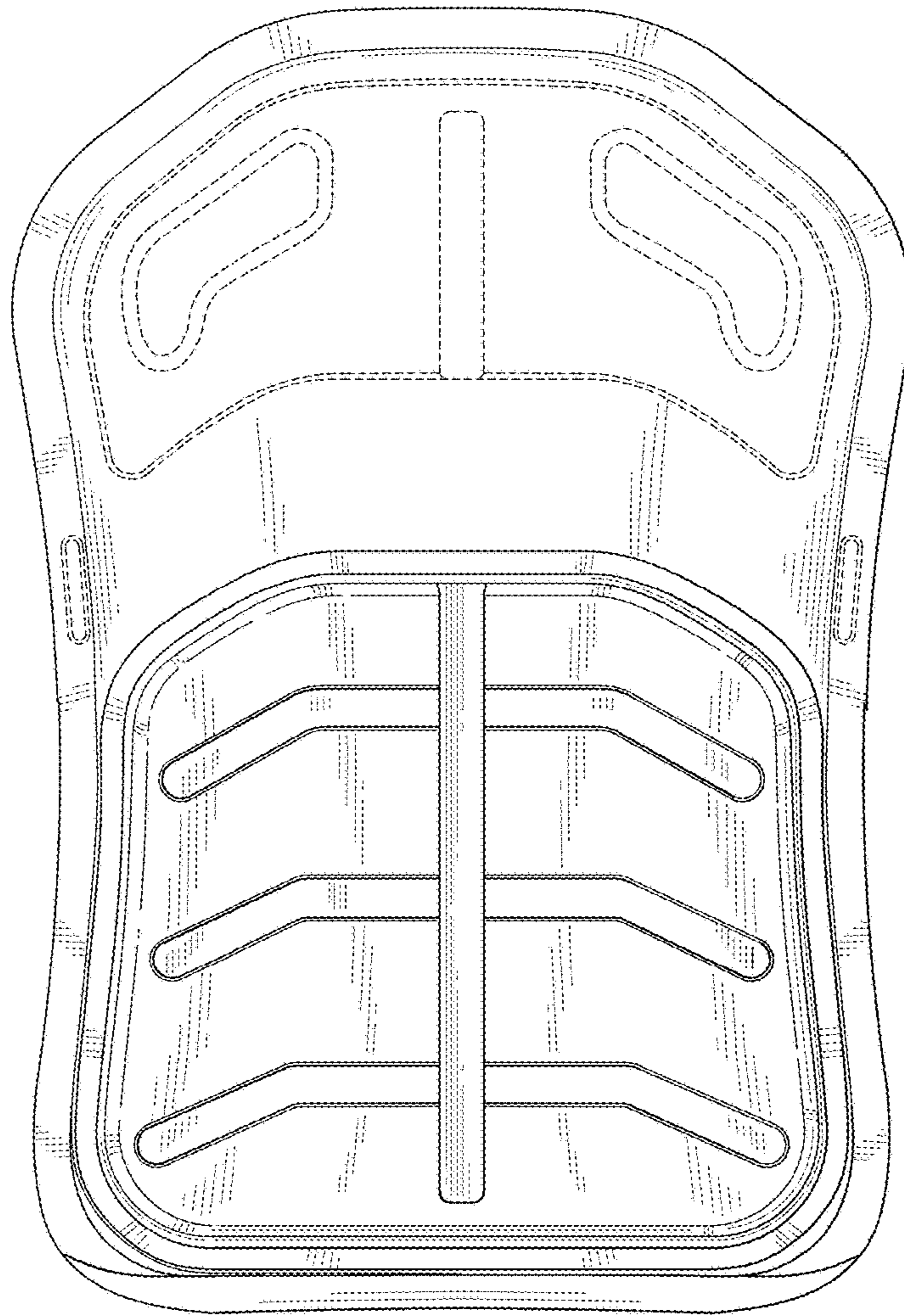

FIG.2

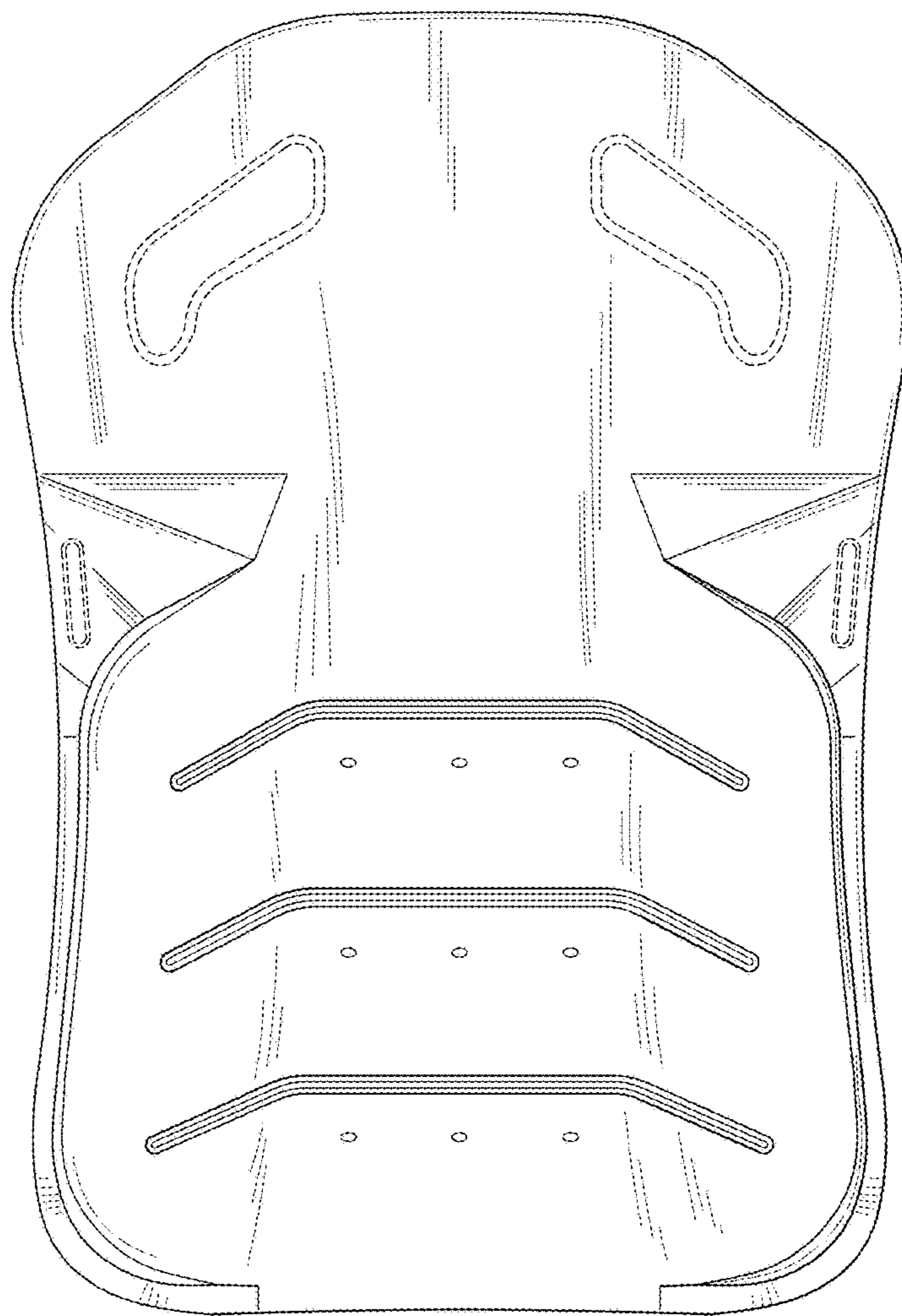

FIG.3

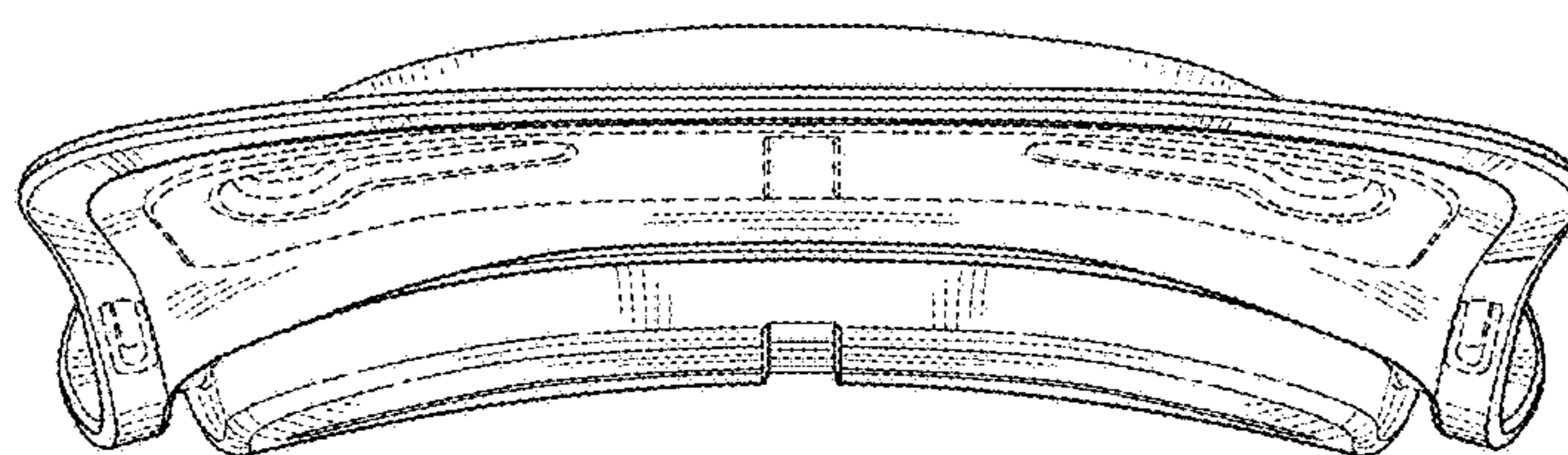

FIG.4

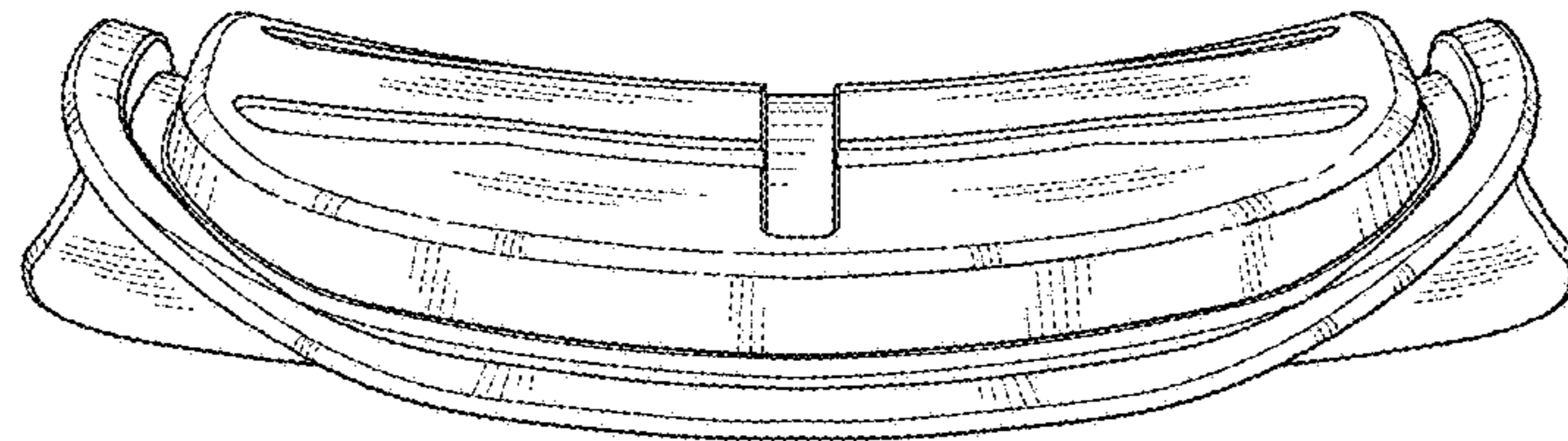

FIG. 5

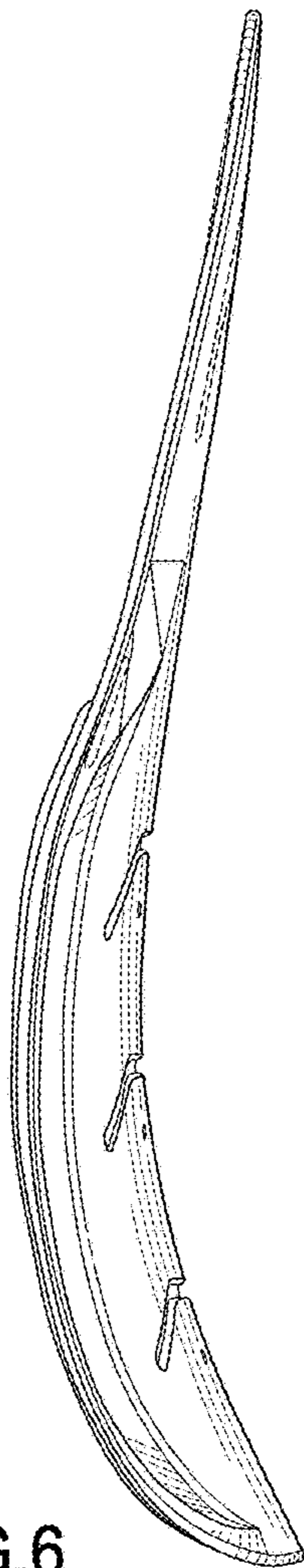

FIG. 6



FIG. 7