



US00D857357S

(12) **United States Design Patent**  
**Khachatourian et al.**

(10) **Patent No.:** **US D857,357 S**

(45) **Date of Patent:** **\*\* Aug. 27, 2019**

- (54) **SHOE**
- (71) Applicant: **NIKE, Inc.**, Beaverton, OR (US)
- (72) Inventors: **Meline Khachatourian**, Portland, OR (US); **Jason G. Petrie**, Portland, OR (US)
- (73) Assignee: **NIKE, Inc.**, Beaverton, OR (US)
- (\*\*) Term: **15 Years**
- (21) Appl. No.: **29/658,328**
- (22) Filed: **Jul. 30, 2018**
- (51) **LOC (12) Cl.** ..... **02-04**
- (52) **U.S. Cl.**  
USPC ..... **D2/946**; D2/976; D2/978
- (58) **Field of Classification Search**  
USPC ..... D2/896, 946, 976, 978, 624, 625, 627, D2/639, 943; D11/200, 222, 26  
CPC .... A43B 1/00; A43B 3/00; A43B 3/12; A43B 7/14; A43B 7/1405; A43B 7/141; A43B 7/1415; A43B 7/142; A43B 7/143; A43B 7/1445; A43B 7/1475; A43B 7/32; A43B 23/24  
See application file for complete search history.

- 4,485,529 A \* 12/1984 Blum ..... A43C 7/005  
24/128
- D287,064 S \* 12/1986 Schnuck ..... D10/116.1
- 4,805,270 A \* 2/1989 Kimbrough ..... A43C 7/00  
24/712.3
- 5,402,589 A \* 4/1995 Lubrani ..... A43C 7/00  
24/712.2
- D376,472 S \* 12/1996 Hatfield ..... D2/976
- 5,649,342 A \* 7/1997 D'Andrade ..... A43C 7/005  
24/712.2
- D406,177 S \* 2/1999 Milroy ..... D2/976
- 5,924,177 A \* 7/1999 Jongejan ..... A43C 7/00  
24/712.2

(Continued)

**OTHER PUBLICATIONS**

Nike Lebron7 P.S. W/Zoom Air—Actual Photos—White/Navy [online], retrieved Oct. 30, 2018], retrieved from Nike Lebron [Internet] <URL: <[https://nikelebron.net/nike\\_lebron\\_ps\\_with\\_zoom\\_air\\_actual\\_photos\\_white\\_navy/](https://nikelebron.net/nike_lebron_ps_with_zoom_air_actual_photos_white_navy/)>; 8 color sheets, Dated Feb. 5, 2010.

(Continued)

*Primary Examiner* — Elizabeth J Oswecki  
(74) *Attorney, Agent, or Firm* — Banner & Witcoff, Ltd.

(57) **CLAIM**

The ornamental design for a shoe, as shown and described.

**DESCRIPTION**

FIG. 1 is a rear view of a shoe showing our new design; FIG. 2 is a first rear perspective view thereof; FIG. 3 is a second rear perspective view thereof; FIG. 4 is a side view thereof; and, FIG. 5 is an opposite side view thereof. The broken lines immediately adjacent to the shaded area define the bounds of the claimed design and form no part thereof. The broken lines depicting the remainder of the shoe show features that form no part of the claimed design.

**1 Claim, 5 Drawing Sheets**

(56) **References Cited**

**U.S. PATENT DOCUMENTS**

- 2,233,544 A \* 3/1941 McKinley ..... A43B 1/0036  
359/519
- 2,650,399 A \* 9/1953 Torelli ..... A43C 7/00  
24/712.2
- 3,066,370 A \* 12/1962 Epstein ..... A43C 7/00  
24/130
- 3,176,362 A \* 4/1965 Tames ..... A43C 7/005  
24/712.2
- 3,500,508 A \* 3/1970 Bennett ..... A43B 3/30  
24/1

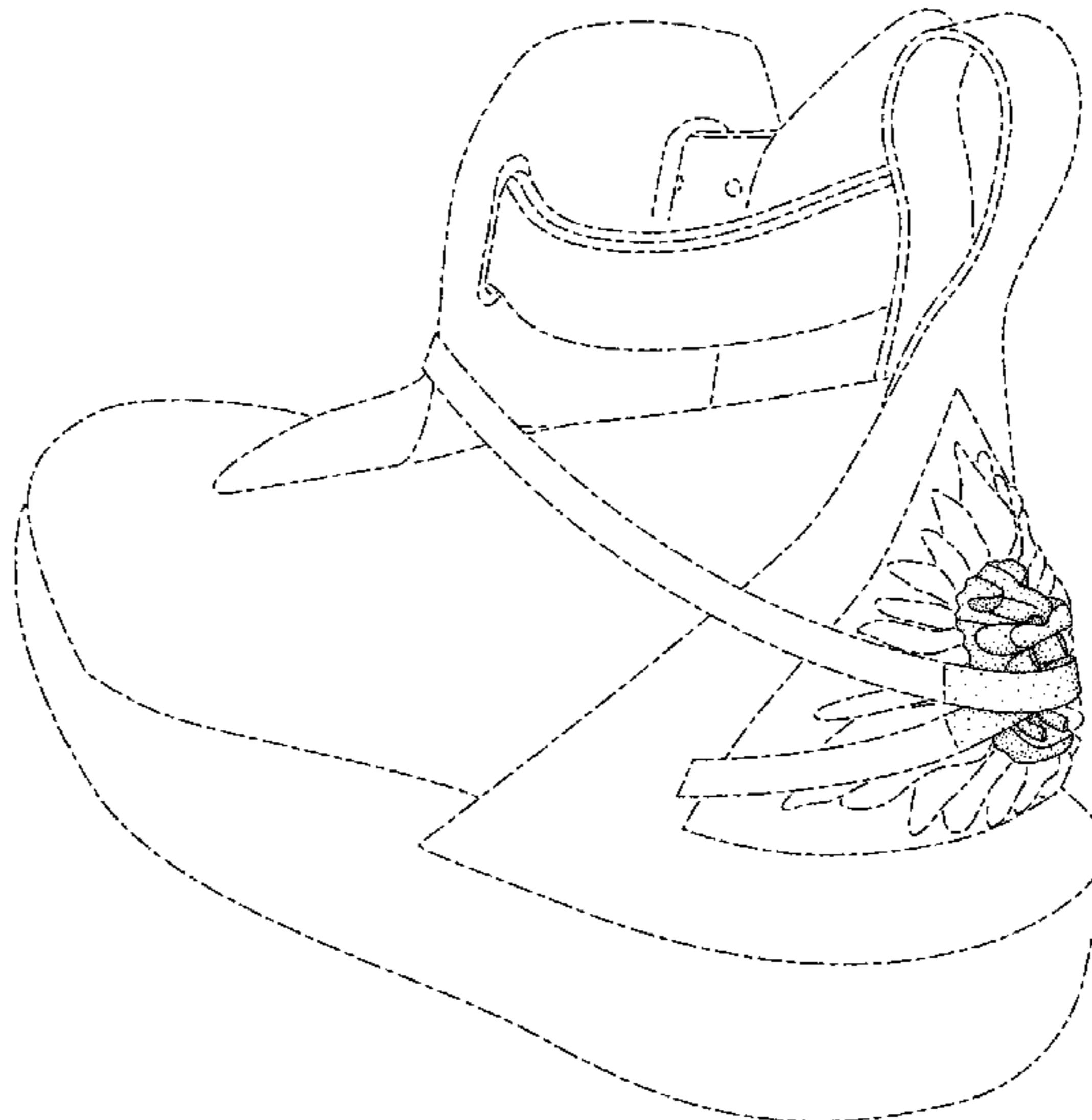
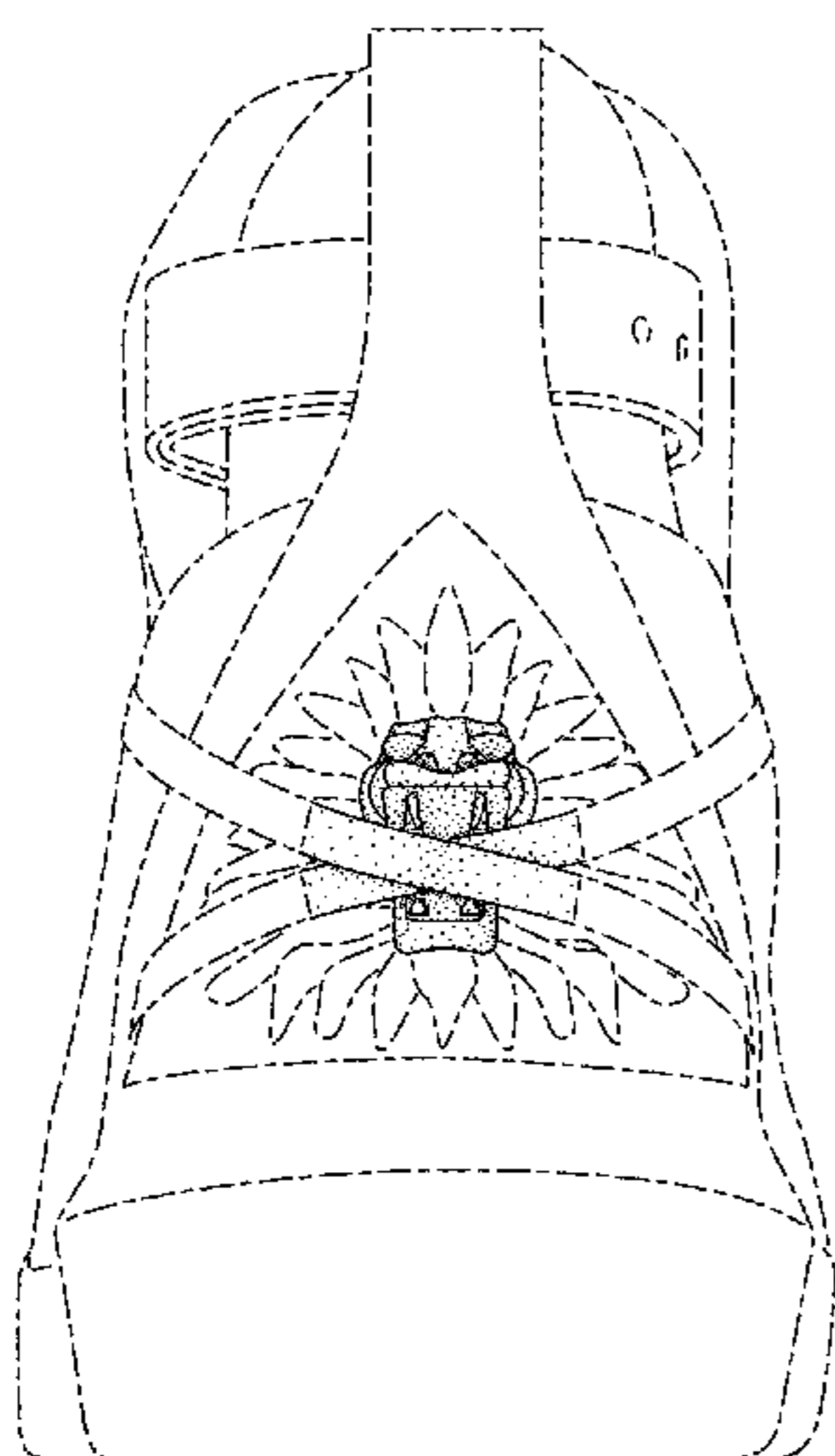

(56)

**References Cited**

U.S. PATENT DOCUMENTS

6,240,607 B1 \* 6/2001 McCrary ..... A43C 1/00  
24/130  
6,247,214 B1 \* 6/2001 Hyde ..... A43C 7/005  
24/712.6  
6,338,186 B1 \* 1/2002 Kleinmann ..... A43C 7/04  
24/712.1  
6,823,610 B1 \* 11/2004 Ashley ..... A43B 3/0078  
36/51  
D623,839 S \* 9/2010 Leleu ..... D2/946  
D650,983 S \* 12/2011 Waldman ..... D2/946  
D657,541 S \* 4/2012 Loverin ..... D2/946  
D664,348 S \* 7/2012 Armstrong ..... D2/946  
D667,212 S \* 9/2012 Reilly ..... D2/976  
D683,116 S \* 5/2013 Petrie .....  
D709,281 S \* 7/2014 Pearson ..... D2/976  
D723,771 S \* 3/2015 Weems ..... D2/946  
D754,960 S \* 5/2016 Fracassi ..... D2/946  
D791,465 S \* 7/2017 Ratzlaff ..... D2/976  
D794,315 S \* 8/2017 Kanata ..... D2/973  
D814,169 S \* 4/2018 Ngene ..... D2/978  
D816,319 S \* 5/2018 Cooper ..... D2/978

D816,980 S \* 5/2018 Chang ..... D2/978  
D837,506 S \* 1/2019 Reilly ..... D2/976  
D838,465 S \* 1/2019 Prochmann ..... D2/976  
D842,602 S \* 3/2019 Rosenblum ..... D2/976  
D843,103 S \* 3/2019 Desaever ..... D2/978

OTHER PUBLICATIONS

Lebron James Laces Up the Nike Zoom Lebron 3 for Game 3 Finals Practice [online], retrieved Oct. 30, 2018], retrieved from Sneaker Bar Detroit [Internet] < URL: <<https://sneakerbardetroit.com/nike-zoom-lebron-3-nba-finals-all-star-pe/>> >; 8 color sheets, Dated Jun. 7, 2016.

Available Now: Nike Lebron 15 BHM 'Equality' [online], retrieved Oct. 30, 2018], retrieved from Nike Lebron [Internet] < URL: <<https://nikelebron.net/available-now-nike-lebron-15-bhm-equality/>> >; 7 color sheets, Dated Jan. 15, 2018.

Photos: Nike Uneils the New Lebron 16, Release Date [online], retrieved Oct. 30, 2018], retrieved from Sports Illustrated [Internet] < URL: <<https://www.si.com/nba/2018/09/07/lebron-james-new-nike-shoe-lebron-16>> >; 2 color sheets, Dated Sep. 7, 2018.

\* cited by examiner

FIG. 1

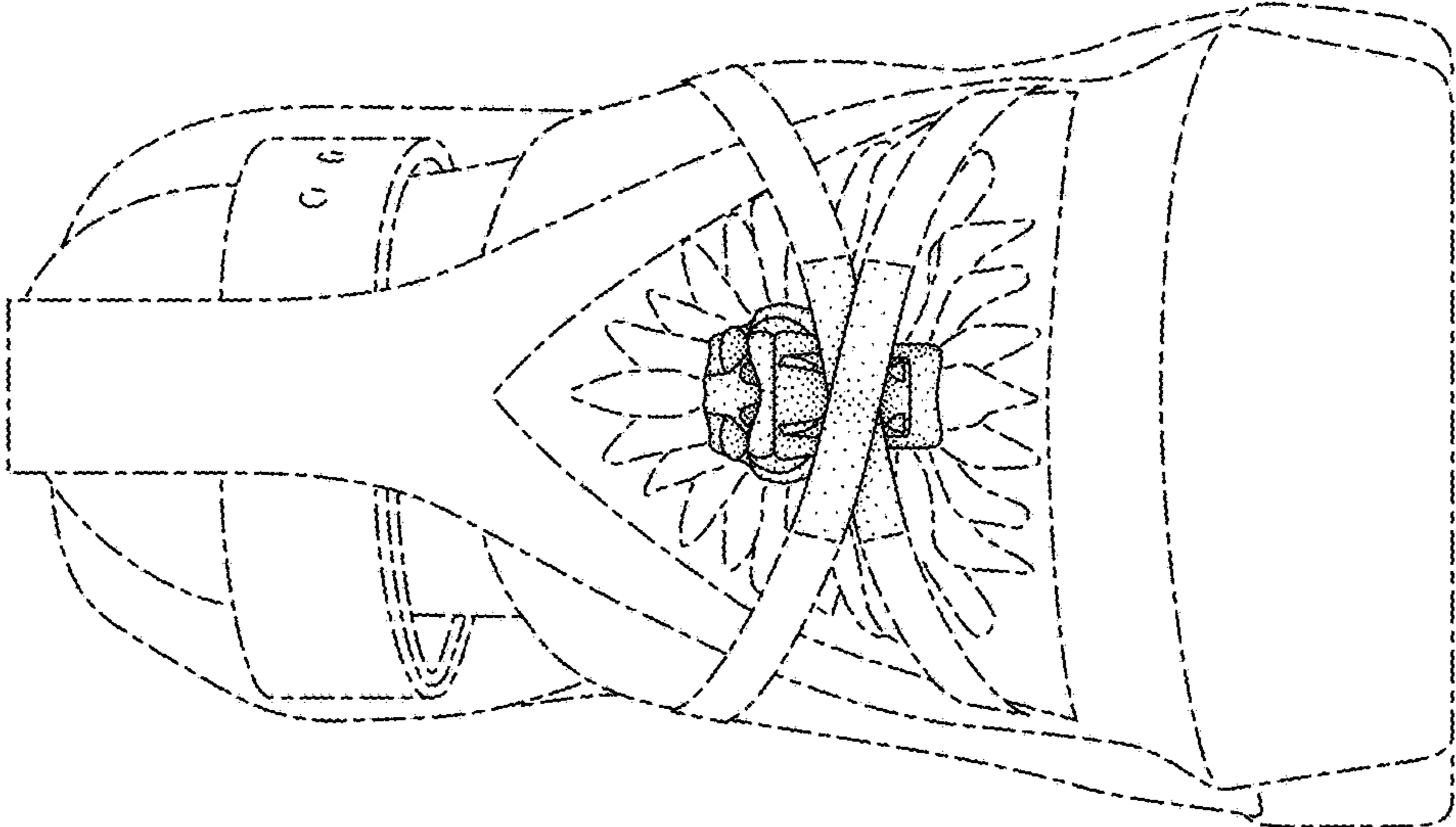

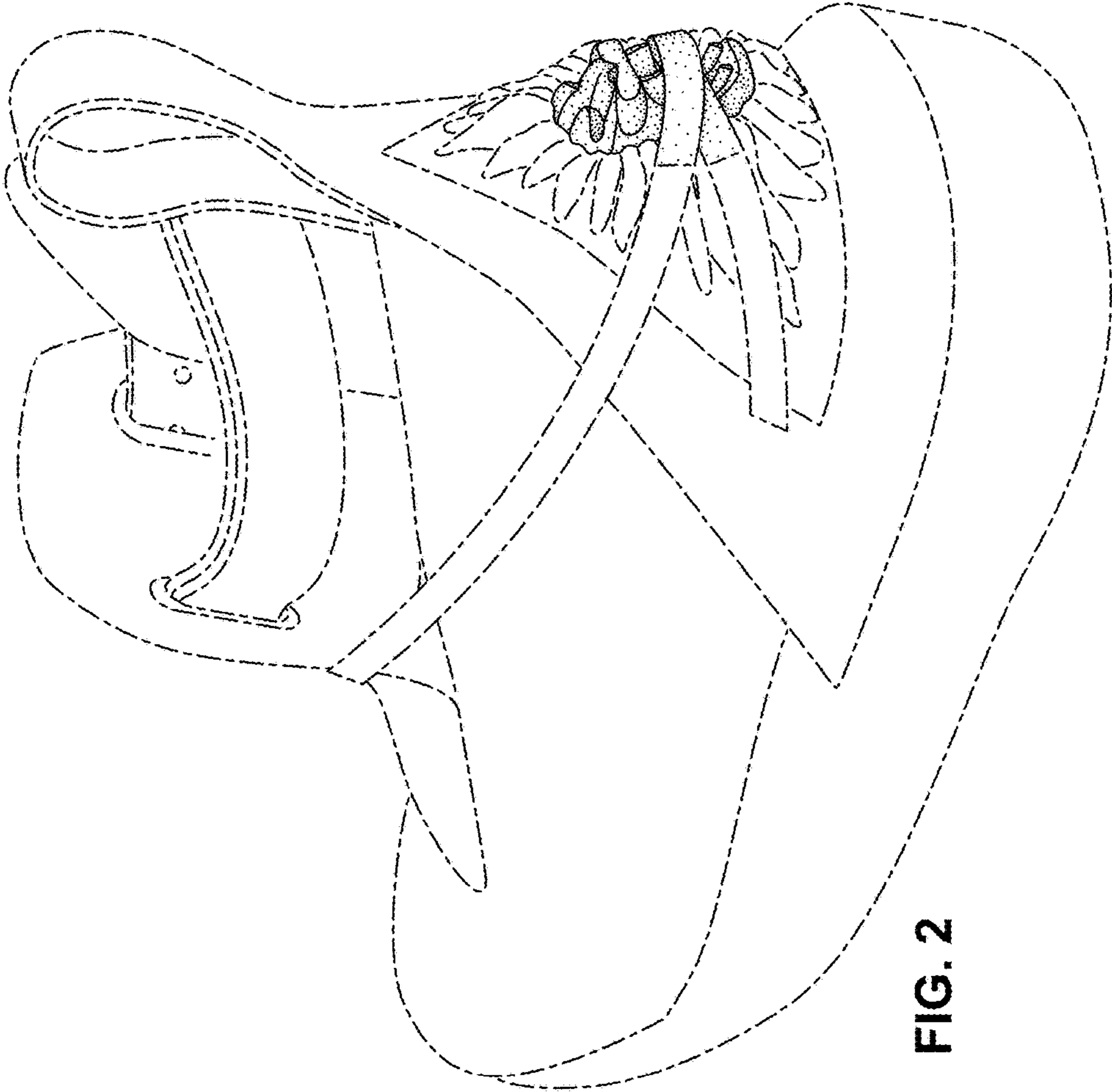

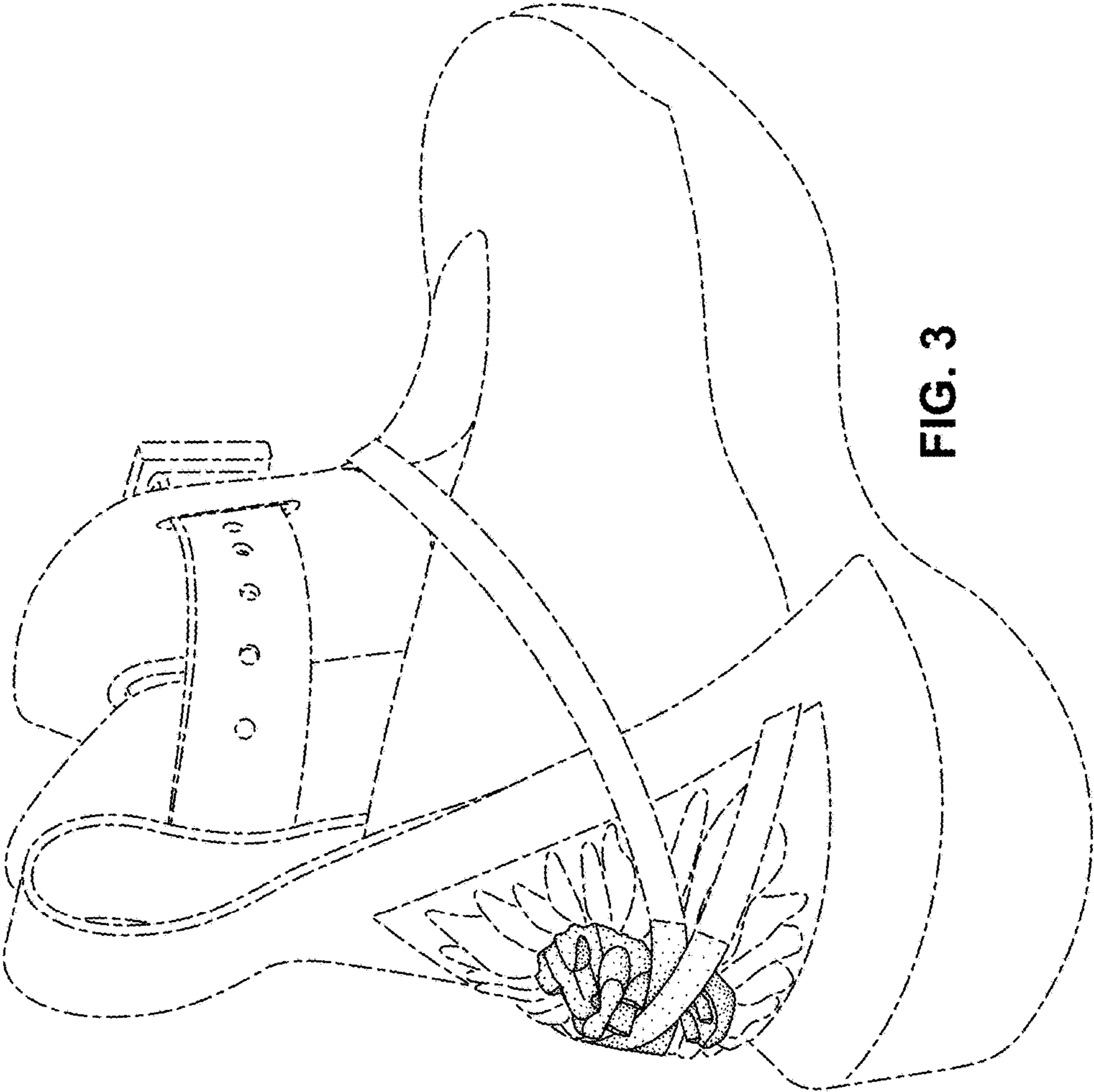

FIG. 3

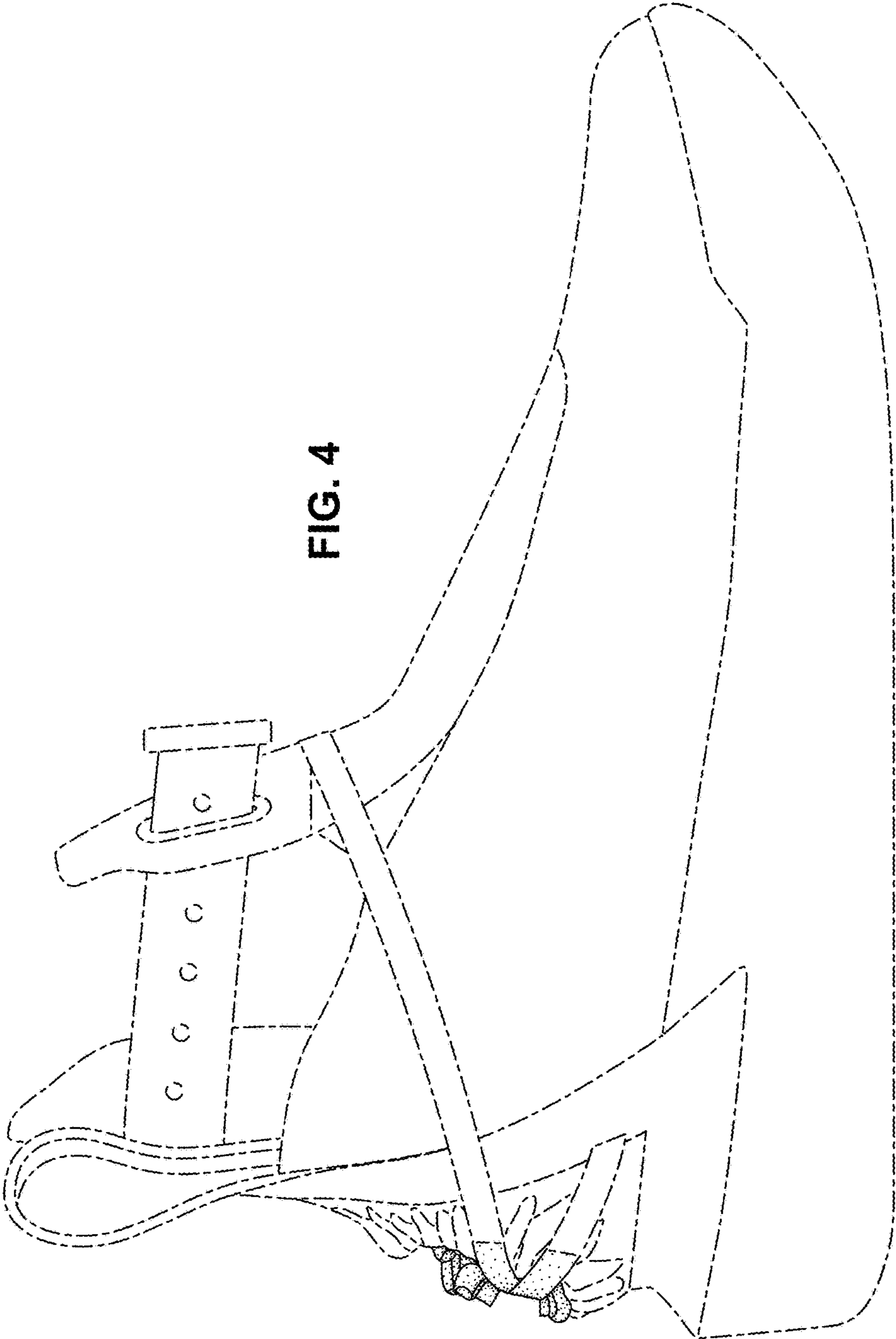

FIG. 4

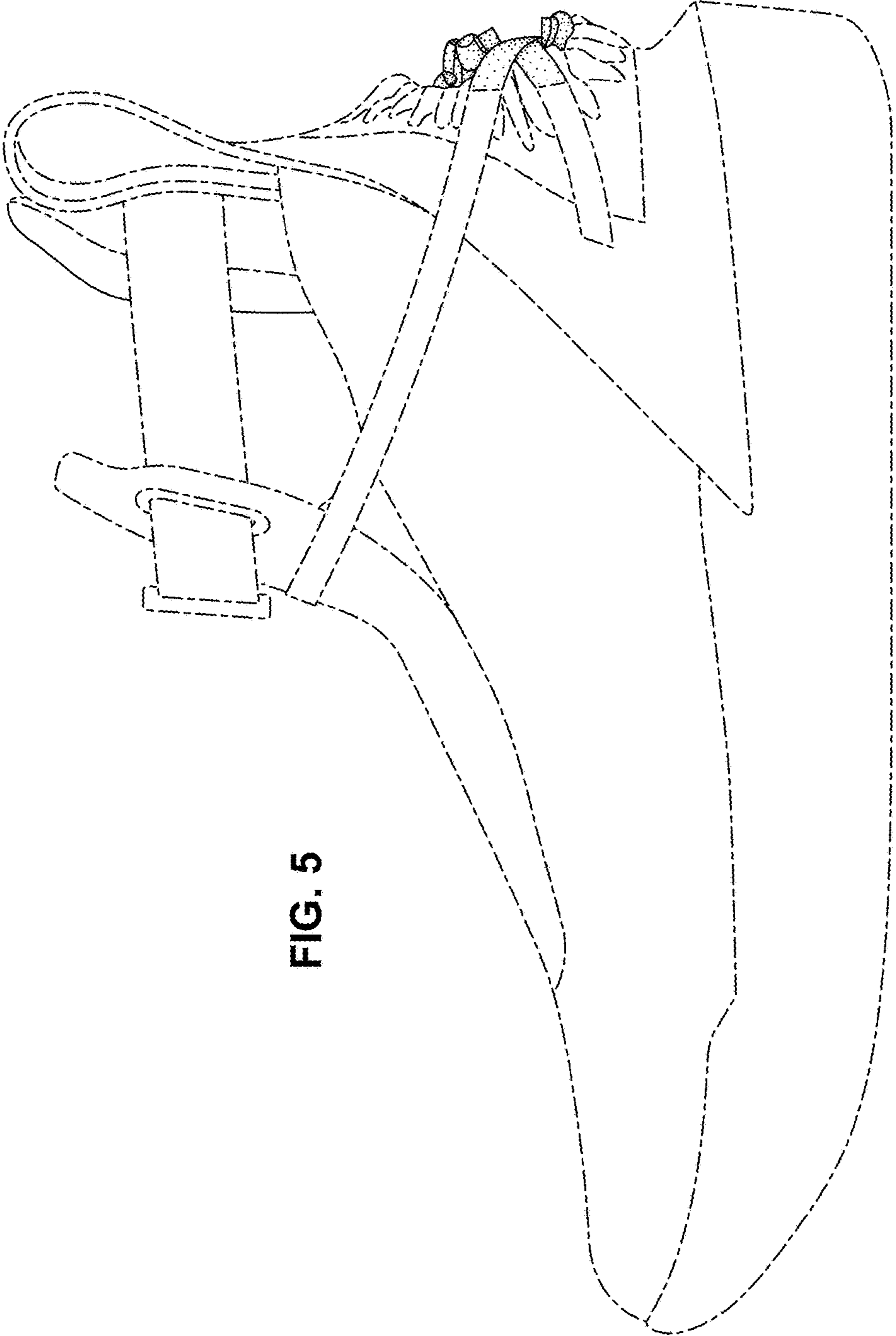

FIG. 5