



US00D857336S

(12) **United States Design Patent** (10) **Patent No.:** **US D857,336 S**
Calucci et al. (45) **Date of Patent:** **** Aug. 27, 2019**

(54) **GOWN WITH POCKETS** 4,622,699 A * 11/1986 Spriggs A41D 13/1236
 2/114
 (71) Applicant: **Medline Industries, Inc.**, Northfield, IL 4,718,124 A * 1/1988 Sawicki A41D 13/129
 (US) 2/114
 4,964,173 A * 10/1990 Gordon A41D 13/1236
 2/114
 (72) Inventors: **Kathleen Calucci**, Mchenry, IL (US); 5,062,159 A * 11/1991 Jakub A41D 13/1236
Daniela L Cherry, Murray, UT (US) 2/105
 (73) Assignee: **Medline Industries, Inc.**, Northfield, IL 5,184,351 A 2/1993 Benstock
 (US) D336,968 S 7/1993 Russano
 D373,893 S 9/1996 Patel et al.
 D378,157 S * 2/1997 Jagger D2/718
 5,878,437 A * 3/1999 Pater A41D 13/1236
 2/114
 (**) Term: **15 Years**
 (21) Appl. No.: **29/633,831** 5,991,923 A 11/1999 Maria
 D419,748 S 2/2000 Sartori
 (22) Filed: **Jan. 16, 2018** 6,216,271 B1 * 4/2001 Chen A41D 13/1245
 2/114

Related U.S. Application Data

(63) Continuation of application No. 29/537,089, filed on Aug. 21, 2015, now Pat. No. Des. 811,692.
 (51) **LOC (12) Cl.** **02-01**
 (52) **U.S. Cl.**
 USPC **D2/720**
 (58) **Field of Classification Search**
 USPC D2/720, 718, 717, 739, 749-751,
 D2/847-850
 CPC A41D 13/1236; A41D 13/1245; A41D
 13/1254; A41D 13/12
 See application file for complete search history.

References Cited

U.S. PATENT DOCUMENTS

D121,838 S 8/1940 Hilby
 2,517,046 A 8/1950 Spengler
 D174,115 S 3/1955 Dior
 3,397,406 A 8/1968 Leach
 D233,634 S 11/1974 Snider
 D236,293 S 8/1975 Banks
 D266,625 S 10/1982 Herman
 4,434,511 A * 3/1984 Weiser A41D 13/129
 2/114
 4,570,268 A * 2/1986 Freeman A41D 13/1236
 2/114

4,622,699 A * 11/1986 Spriggs A41D 13/1236
 2/114
 4,718,124 A * 1/1988 Sawicki A41D 13/129
 2/114
 4,964,173 A * 10/1990 Gordon A41D 13/1236
 2/114
 5,062,159 A * 11/1991 Jakub A41D 13/1236
 2/105
 5,184,351 A 2/1993 Benstock
 D336,968 S 7/1993 Russano
 D373,893 S 9/1996 Patel et al.
 D378,157 S * 2/1997 Jagger D2/718
 5,878,437 A * 3/1999 Pater A41D 13/1236
 2/114
 5,991,923 A 11/1999 Maria
 D419,748 S 2/2000 Sartori
 6,216,271 B1 * 4/2001 Chen A41D 13/1245
 2/114
 D457,289 S 5/2002 Shorr
 D463,093 S 9/2002 Murray
 D495,468 S 9/2004 Wheeler-Dickson et al.
 D533,982 S 12/2006 Graneto, III
 D547,927 S 8/2007 Booth
 7,305,716 B1 * 12/2007 Richards A41D 13/1245
 2/114
 D563,627 S 3/2008 Warren
 D564,730 S 3/2008 Farrell
 D565,279 S 4/2008 Farrell
 D573,776 S 7/2008 Thunstedt
 7,395,556 B2 7/2008 Eraca
 D574,126 S 8/2008 McCray
 D584,483 S 1/2009 Glynn
 D584,882 S 1/2009 Trouillot et al.
 D594,632 S 6/2009 Long
 D598,638 S 8/2009 Graneto, III
 D612,126 S 3/2010 Milgrom
 D622,479 S 8/2010 Herzog
 D635,739 S 4/2011 Toms et al.
 D636,558 S 4/2011 Shelton
 D647,688 S * 11/2011 Hilgart D2/720
 D656,710 S 4/2012 Farris et al.
 D657,529 S 4/2012 Farris et al.
 D657,530 S 4/2012 Farris et al.
 8,359,666 B2 1/2013 Appel et al.
 D680,709 S 4/2013 Blood
 D688,847 S 9/2013 Isaacs
 D690,078 S 9/2013 Anderson
 D692,655 S 11/2013 Perrea et al.
 D698,529 S 2/2014 Vanneste
 D708,821 S 7/2014 Iamartino
 D721,869 S 2/2015 Bernier
 D721,870 S 2/2015 Levine
 D722,743 S * 2/2015 Nice D2/717

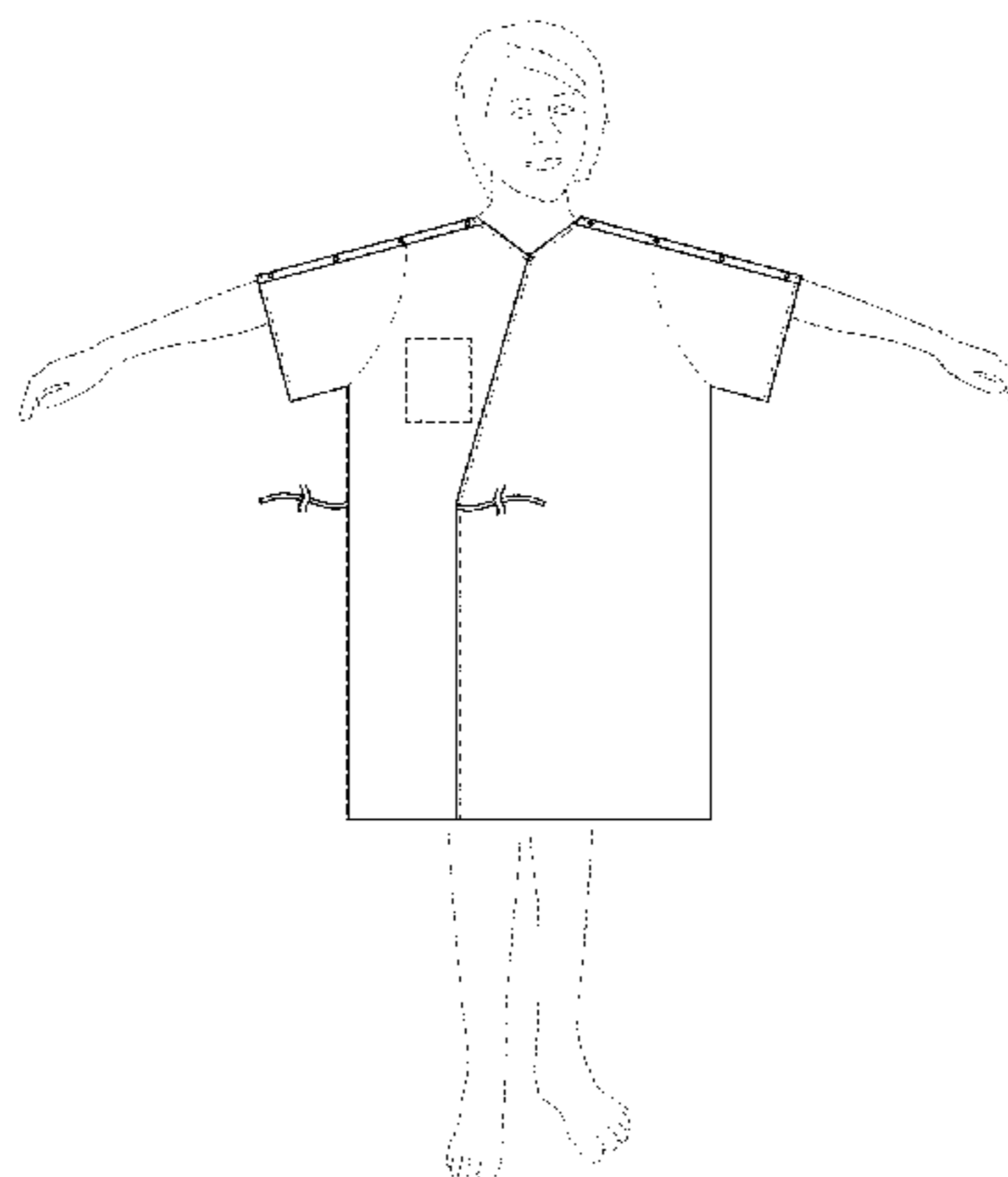

8,990,966	B2	3/2015	Furstenberg et al.	
D736,493	S	8/2015	Pasko	
D738,591	S	9/2015	Criss	
D741,044	S	10/2015	Pasko	
D741,569	S	10/2015	Fredrickson	
D785,285	S *	5/2017	Shamsid-Deen	D2/720
D796,781	S *	9/2017	Calucci	D2/720
D797,409	S *	9/2017	Yadrich	D2/840
D802,884	S *	11/2017	Bennett	D2/739
2002/0162154	A1 *	11/2002	Shamam	A41D 13/1245 2/69
2008/0000006	A1 *	1/2008	Ochoa	A41D 13/1236 2/114
2008/0184455	A1	8/2008	Blume	
2009/0100569	A1	4/2009	Butler	
2010/0050315	A1	3/2010	Christou-Kelly	
2011/0231981	A1	9/2011	Appel et al.	
2013/0036526	A1 *	2/2013	Rashman	A41D 13/1245 2/114
2013/0131617	A1 *	5/2013	Kovensky	A41D 13/1281 604/327
2014/0082823	A1 *	3/2014	Gordon	A41D 13/1236 2/114
2015/0059048	A1	3/2015	Stanley	
2015/0135397	A1	5/2015	Levine	
2015/0157069	A1	6/2015	Hieber et al.	
2015/0374048	A1	12/2015	Theodossiou	
2016/0278456	A1 *	9/2016	Monardo	A41D 13/1236

OTHER PUBLICATIONS

Bring you own hospital gown? Yea or Nay?; posted at blogs.babycenter.com, earliest available Apr. 9, 2012 [online], Nov. 15, 2016; http://blogs.babycenter.com/products_and_prizes/bring-your-own-hospital-gowns-yea-or-nay/.
 Think Again: The Hospital Gown; posted at atissuejournal.com; earliest date available Apr. 6, 2009 [online], Nov. 6, 2016; www.atissuejournal.com/2009/04/06/bad-design-1-the-hospital-gown/.
 “Amplewear Exam Gowns by Little Rapids”, Medline Catalog; <http://www.medline.com/catalog/catalog.jsp>; Unknown Publication date but believed to be prior to filing date of present application.
 “Exam Rehab Vests”, TIDI Products; 960202; <http://www.medequipdepot.com/products/960202-tidi-products-llc-exam-rehab-vests-x-large-10-bg-5-bg-cs-sold-as-cs.html>; Unknown Pub Date but believed to be prior to filing of present application.
 “Royale Print Deluxe Cut IV Patient Gowns”, Medline Catalog; <http://www.medline.com/catalog/catalog.jsp>; Unknown Publication date but believed to be prior to filing date of present application.
 “Sketch”, Sketch by Inventor—The University of Michigan Gown; Publication Date of Gown depicted in sketch unknown, but believed to be prior to earliest priority date of present application; Received May 8, 2015.
 Moore Jr, Clese, “Notice of Allowance”, U.S. Appl. No. 29/537,089, filed Aug. 21, 2015; dated Jun. 29, 2017.
 Soroush, Aula, “Final OA”, U.S. Appl. No. 29/539,506, filed Sep. 15, 2015; dated Jul. 11, 2017.
 Soroush, Aula, “NonFinal OA”, U.S. Appl. No. 29/539,506, filed Sep. 15, 2015; dated Nov. 15, 2016.

* cited by examiner

Primary Examiner — Michelle E. Wilson
 Assistant Examiner — Clese Moore, Jr.
 (74) Attorney, Agent, or Firm — Philip H. Burrus, IV

(57) CLAIM

The ornamental design for a gown with pockets, as shown and described.

DESCRIPTION

FIG. 1 is a front elevation view of a gown with pockets, shown in use with an untied configuration with the opening of the gown positioned to the front of the user and showing our new design;

FIG. 2 is a rear elevation view thereof;
 FIG. 3 is a rear elevation view thereof shown in an alternate position, with the opening of the gown positioned to the back of the user;
 FIG. 4 a front elevation view thereof shown with the opening of the gown positioned to the back of the user;
 FIG. 5 is a front elevation view of a gown with pockets, shown in use, in a tied configuration with the opening of the gown positioned to the front of the user;
 FIG. 6 is a front elevation view thereof shown in an alternate position, with the opening of the gown positioned to the back of the user as shown in FIG. 5;
 FIG. 7 is a left elevation view shown in an untied and expanded configuration;
 FIG. 8 is a right elevation view view thereof;
 FIG. 9 is a top plan view thereof;
 FIG. 10 is a bottom plan view thereof;
 FIG. 11 is a rear elevation view shown in an untied and flattened configuration;
 FIG. 12 is a front elevation thereof;
 FIG. 13 is a front elevation view with a left, rear flap of the gown folded open to expose the right, rear flap of the gown;
 FIG. 14 is a front elevation view thereof with both the left, rear flap and the right, rear flap folded open to expose the interior of the gown;
 FIG. 15 is another front elevation view of a gown with pockets, shown in use with the straps shown in broken lines, in an untied configuration with the opening of the gown positioned to the front of the user; and
 FIG. 16 is a rear elevation view thereof;
 FIG. 17 is a rear elevation view thereof shown in an alternate position, with the opening of the gown positioned to the back of the user;
 FIG. 18 is a front elevation view thereof shown with the opening of the gown positioned to the back of the user;
 FIG. 19 is a front elevation view of a gown with pockets, shown in use, in a tied configuration with the opening of the gown positioned to the front of the user;
 FIG. 20 is a front elevation view thereof shown in an alternate position, with the opening of the gown positioned to the back of the user as shown in FIG. 19;
 FIG. 21 is a left elevation view shown in an untied and expanded configuration;
 FIG. 22 is a right elevation view thereof;
 FIG. 23 is top plan view thereof;
 FIG. 24 is a bottom plan view thereof;
 FIG. 25 is a rear elevation view shown in an untied and flattened configuration;
 FIG. 26 is a front elevation view view thereof;
 FIG. 27 is a front elevation view with a left, rear flap of the gown folded open to expose the right, rear flap of the gown; and,
 FIG. 28 is a front elevation view thereof with both the left, rear flap and the right, rear flap of the gown folded open to expose the interior of the gown.
 The broken lines of the human user shown in FIGS. 1-6 and 15-20 illustrate environment, and all other broken lines shown illustrate portions of the gown with pockets that form no part of the claimed design.

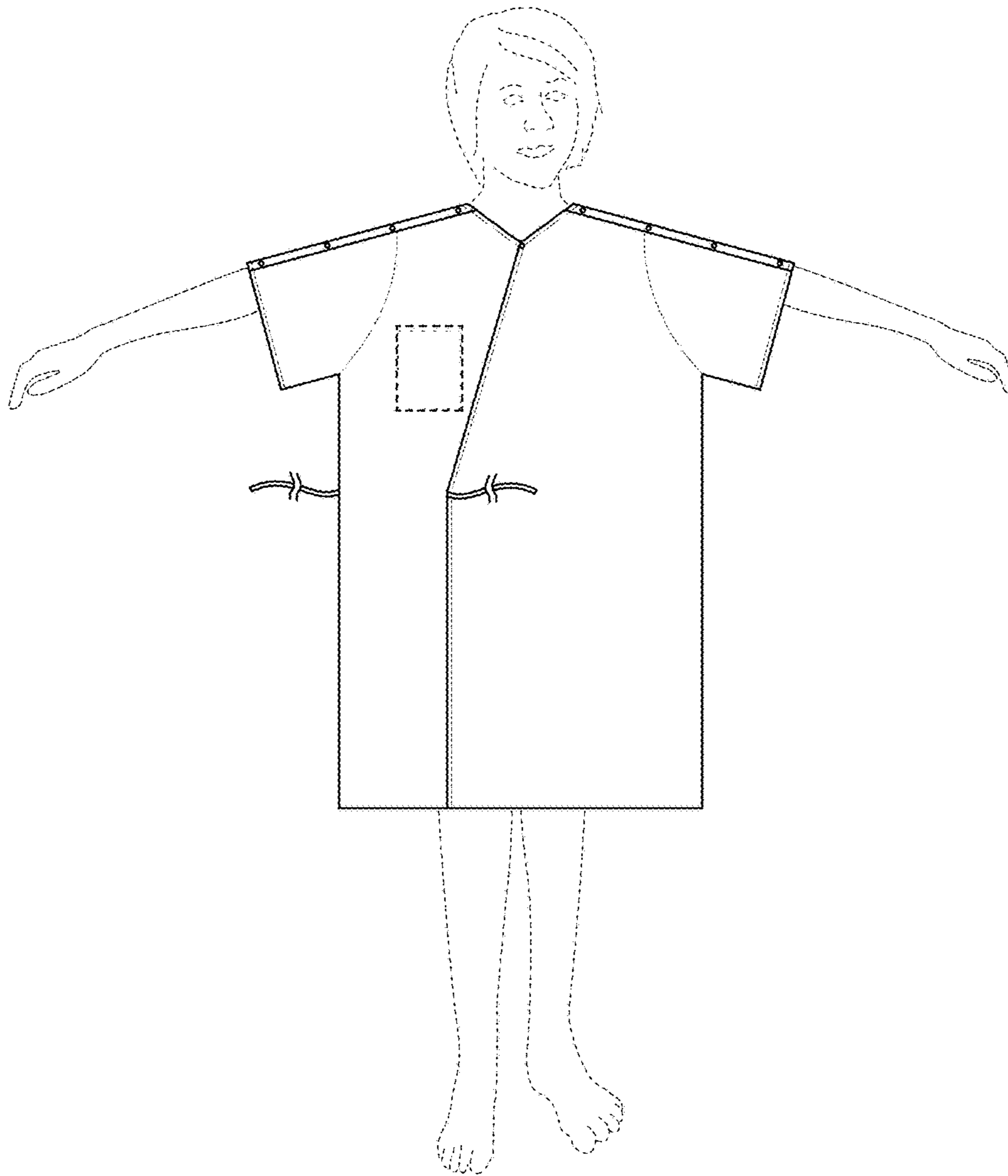

FIG. 1

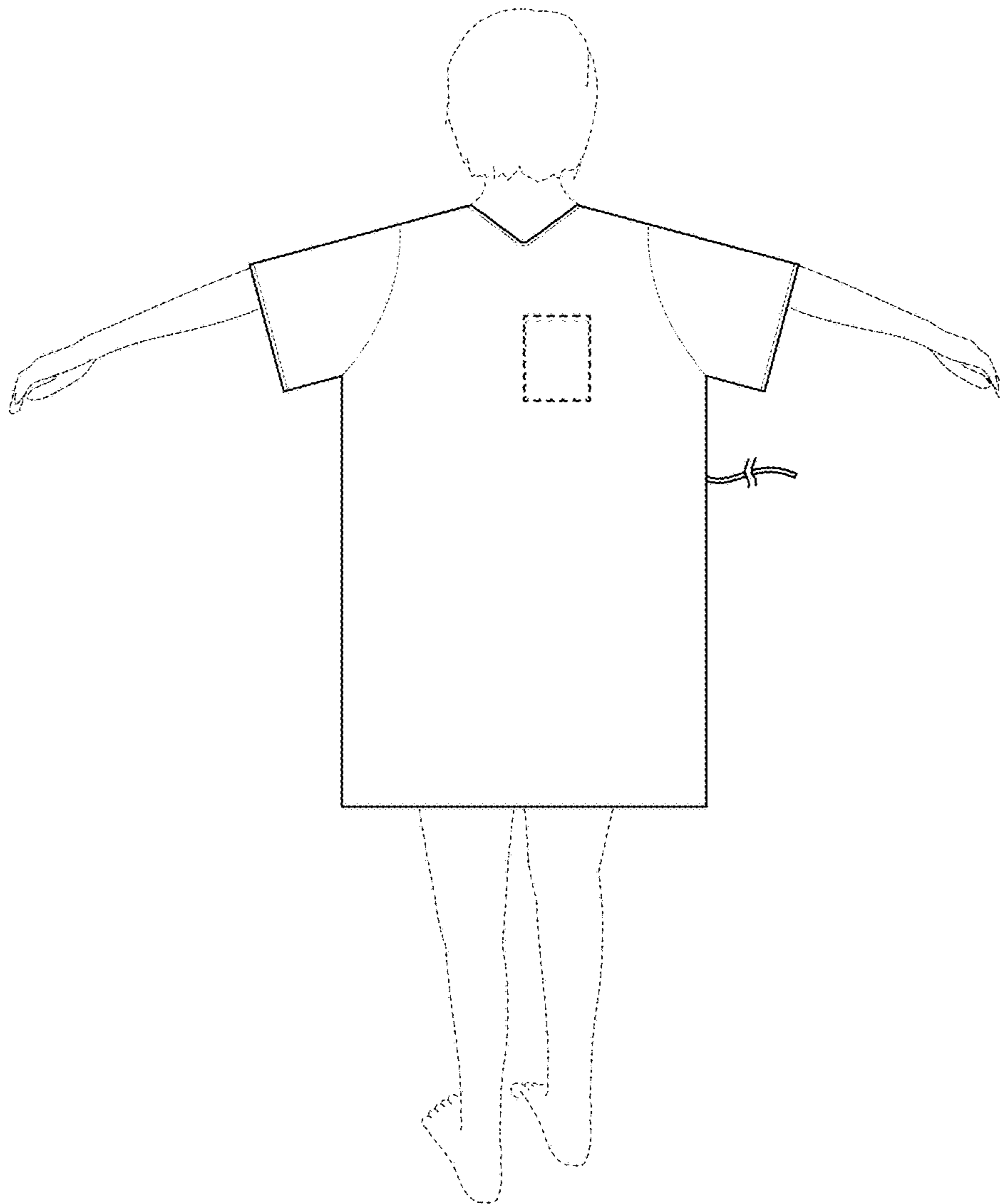

FIG. 2

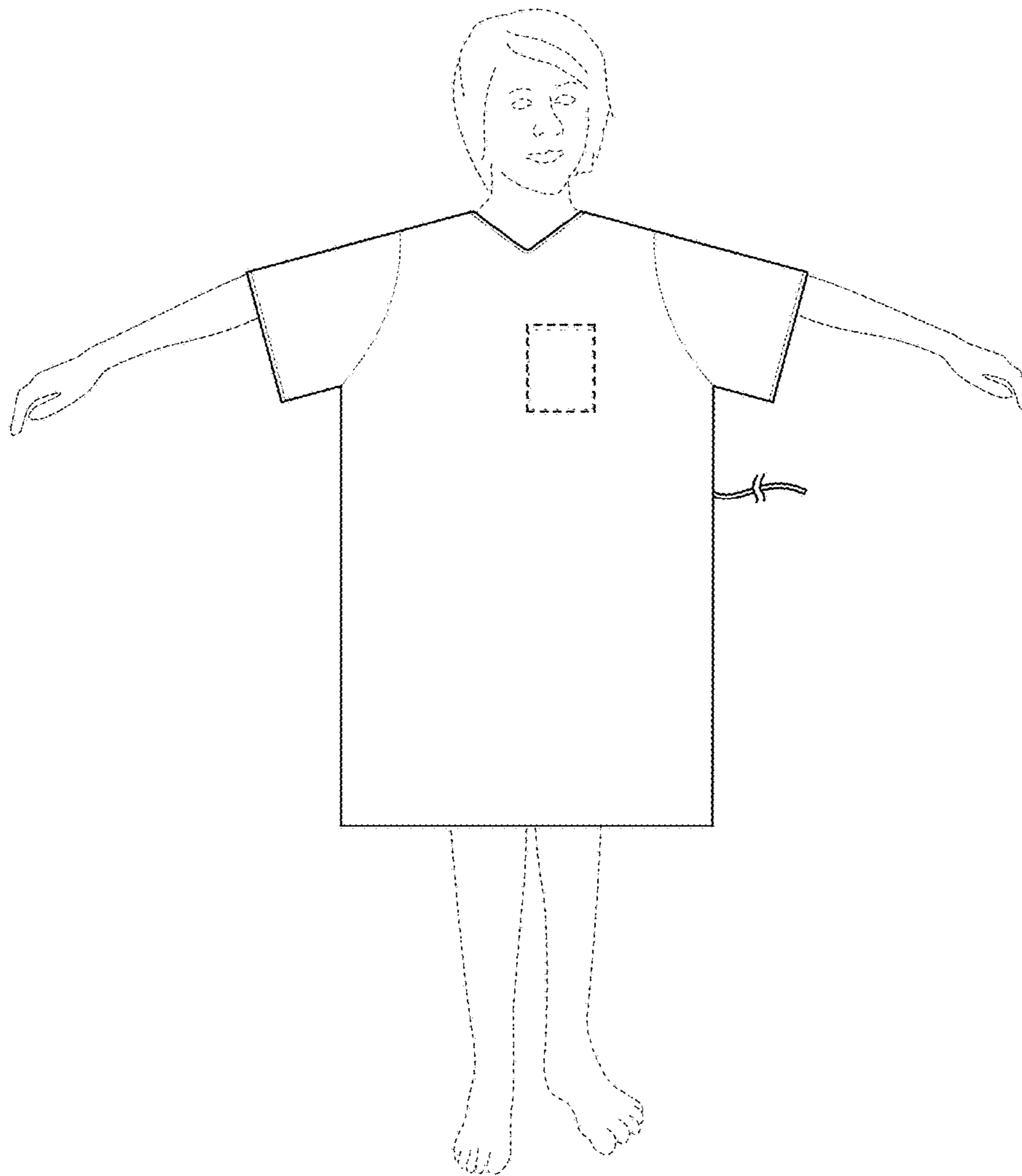

FIG. 3

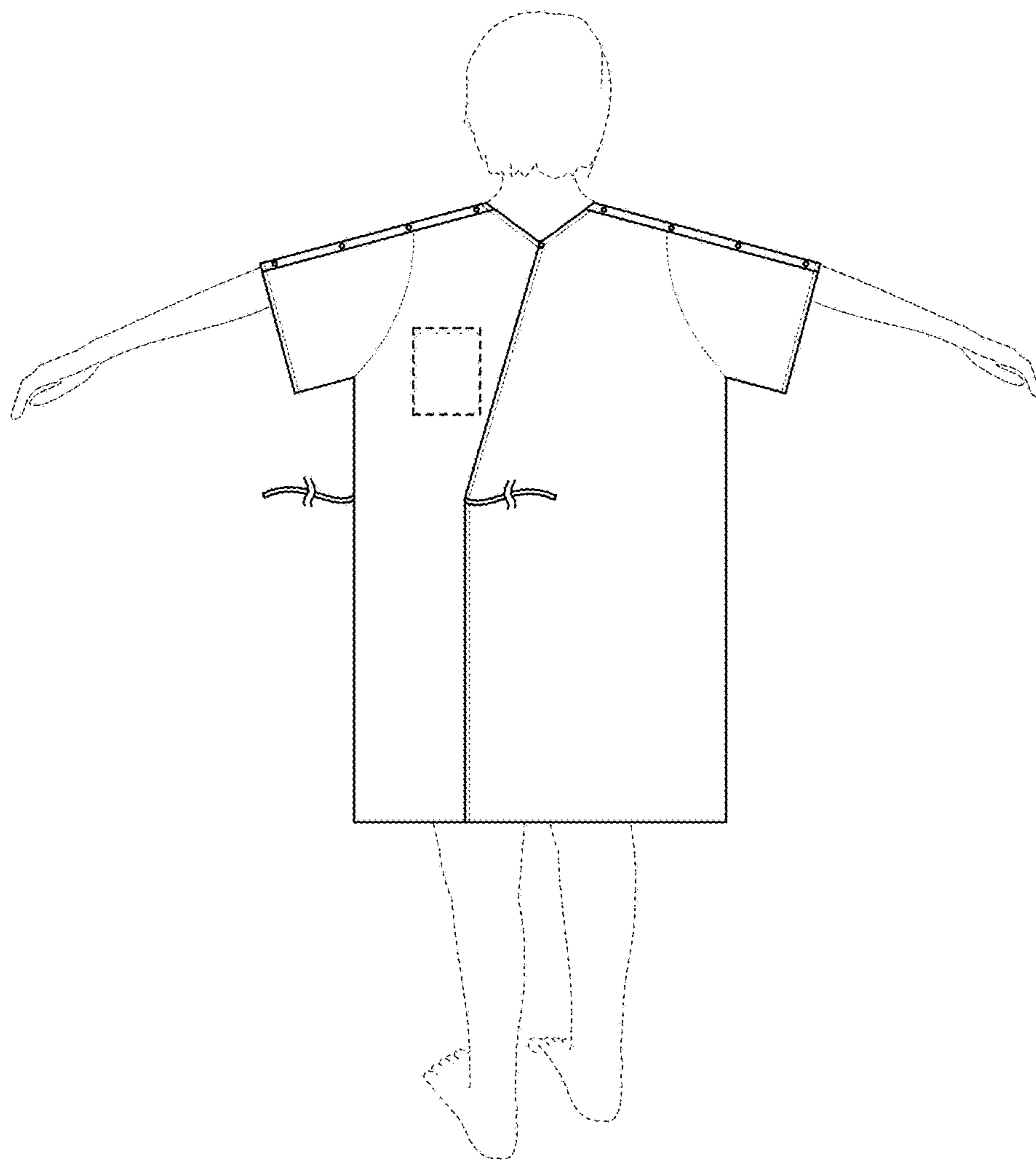

FIG. 4

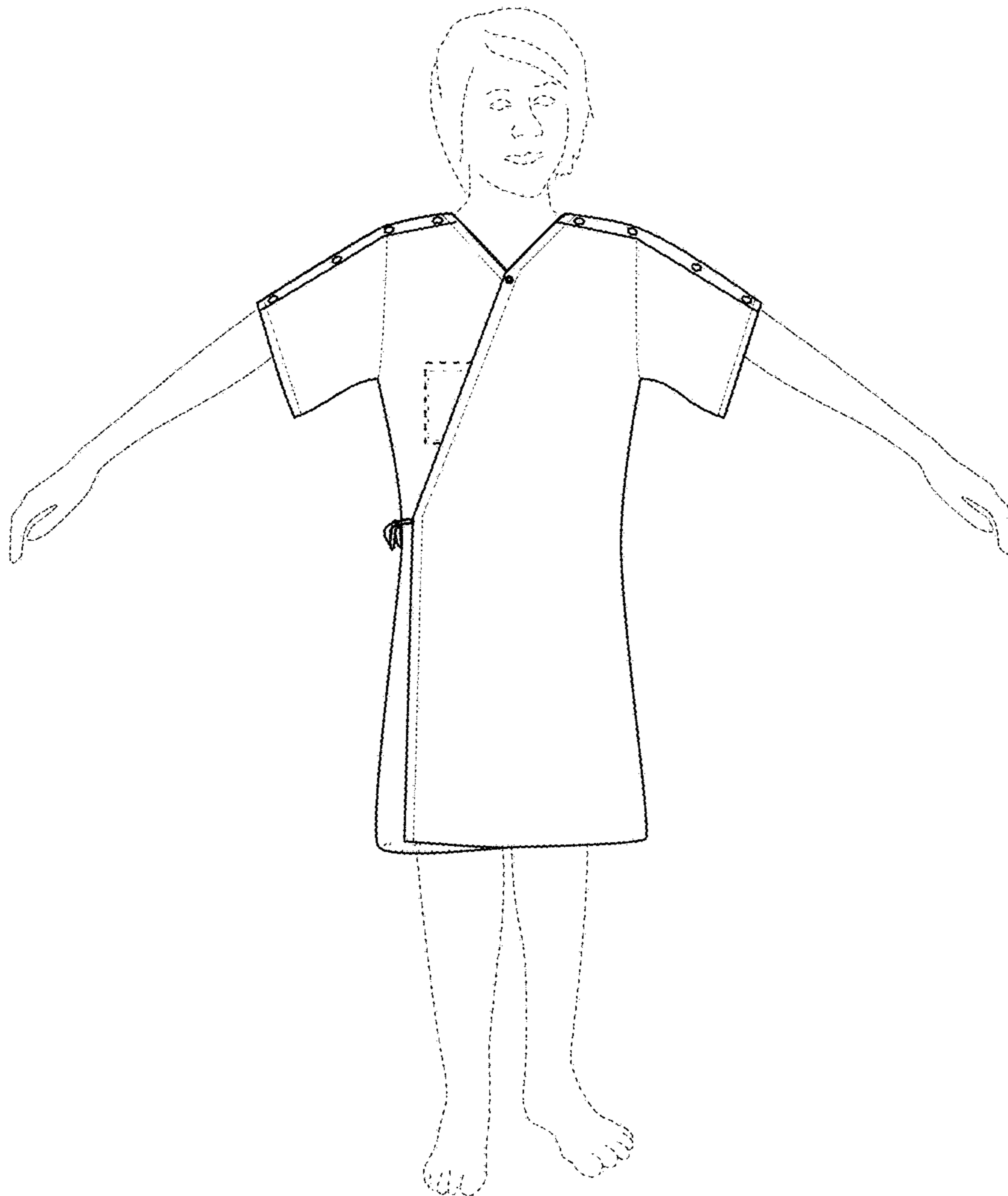

FIG. 5

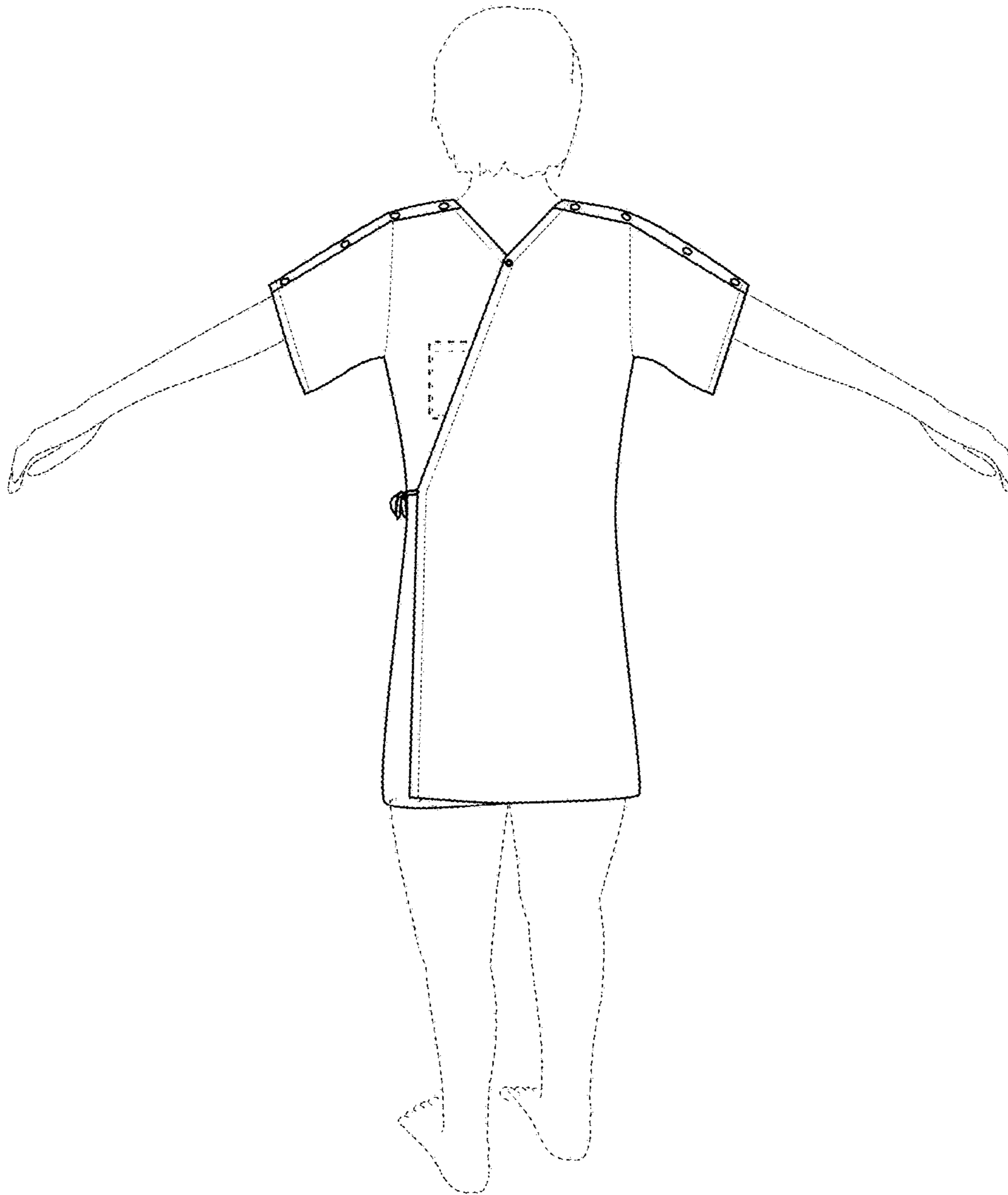

FIG. 6

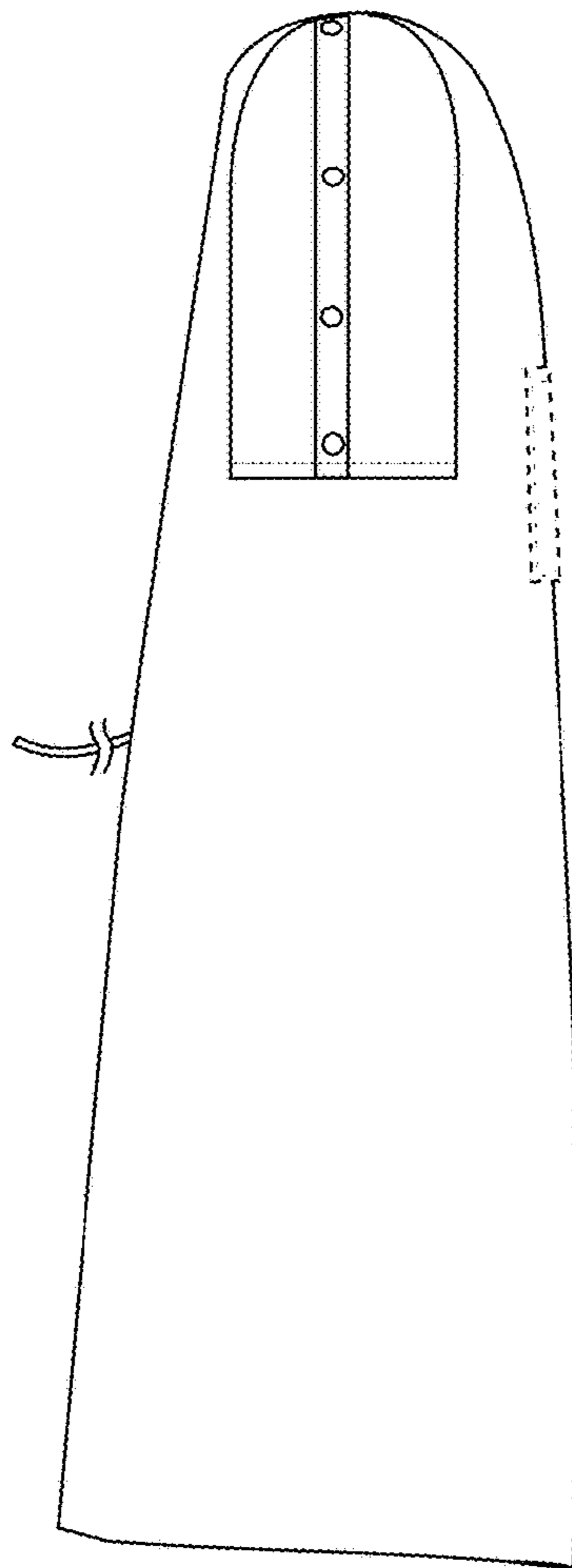

FIG. 7

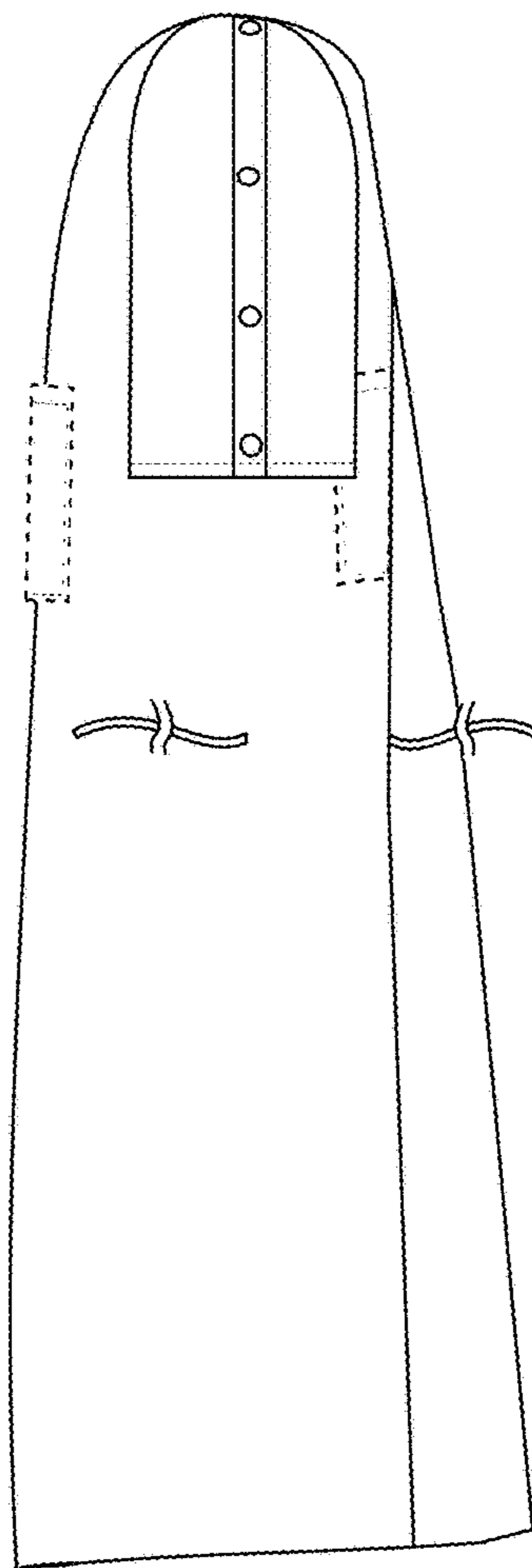

FIG. 8

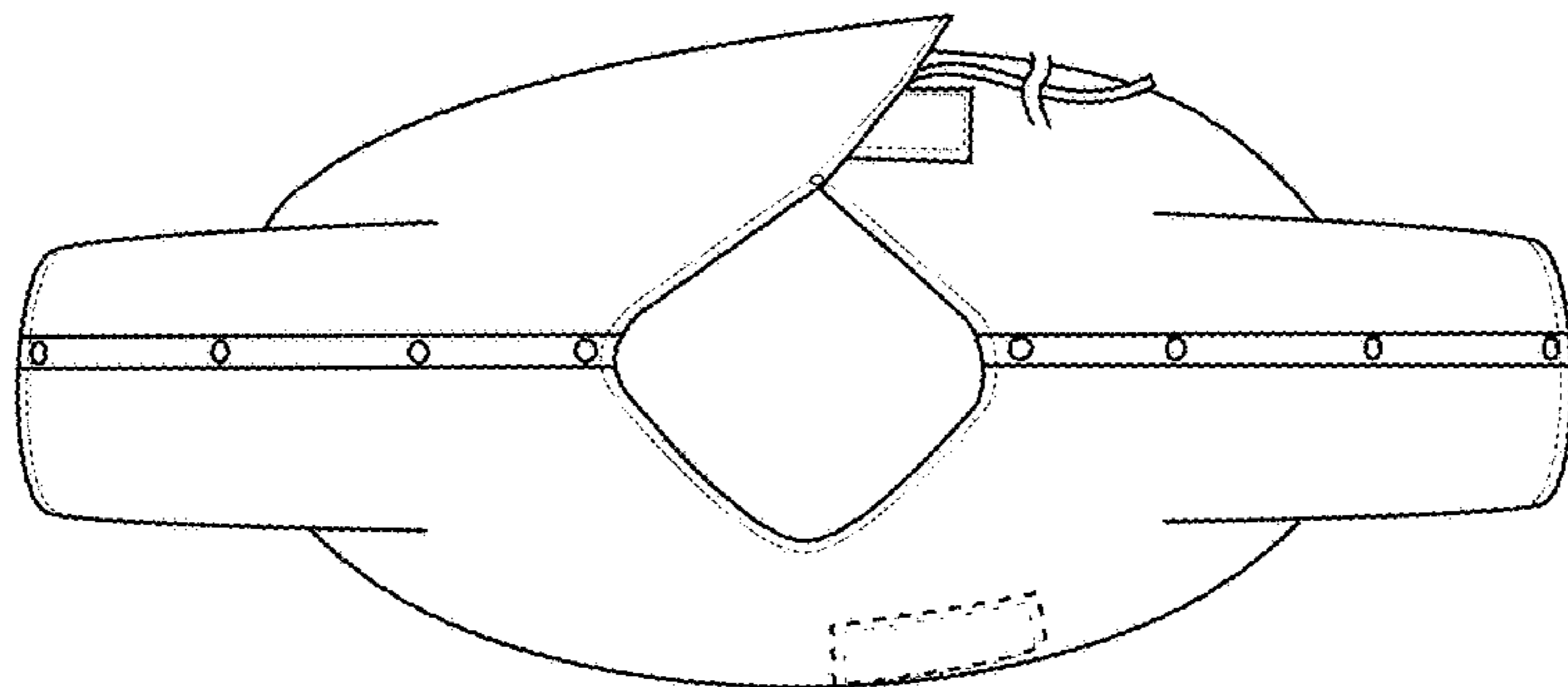

FIG. 9

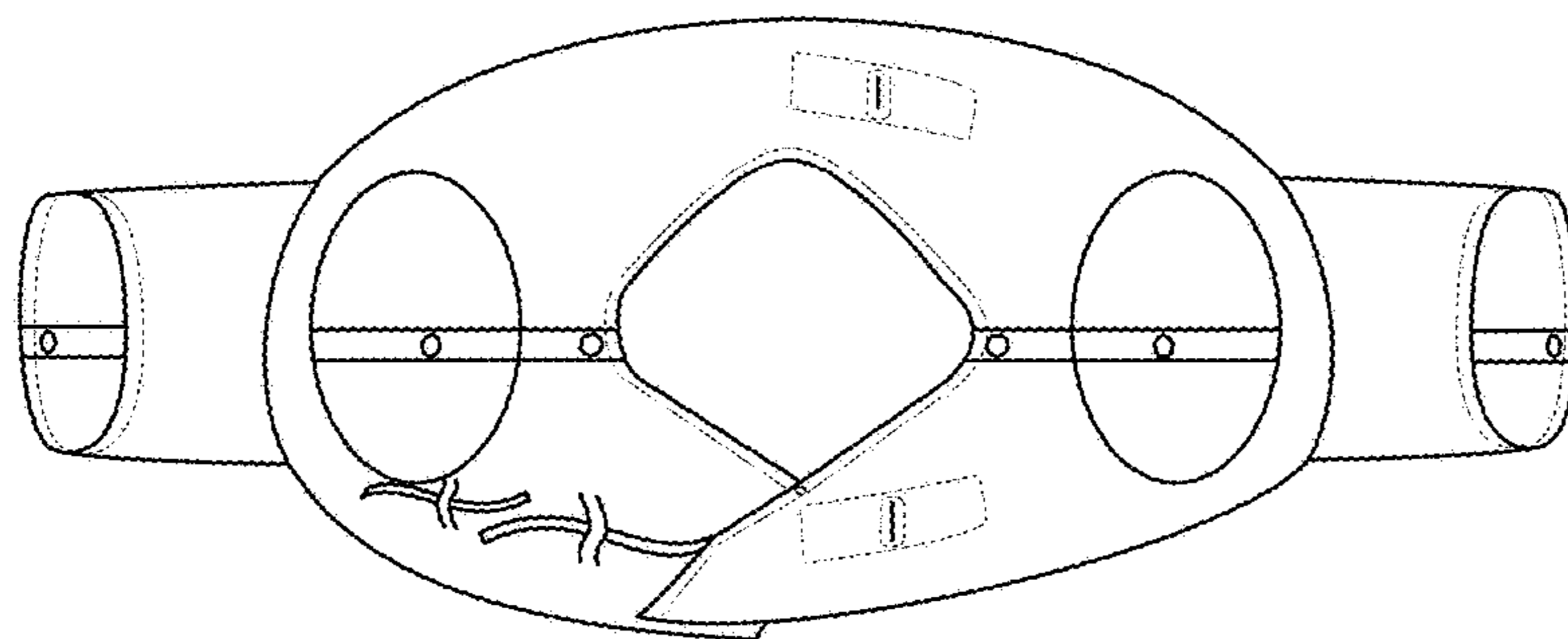

FIG. 10

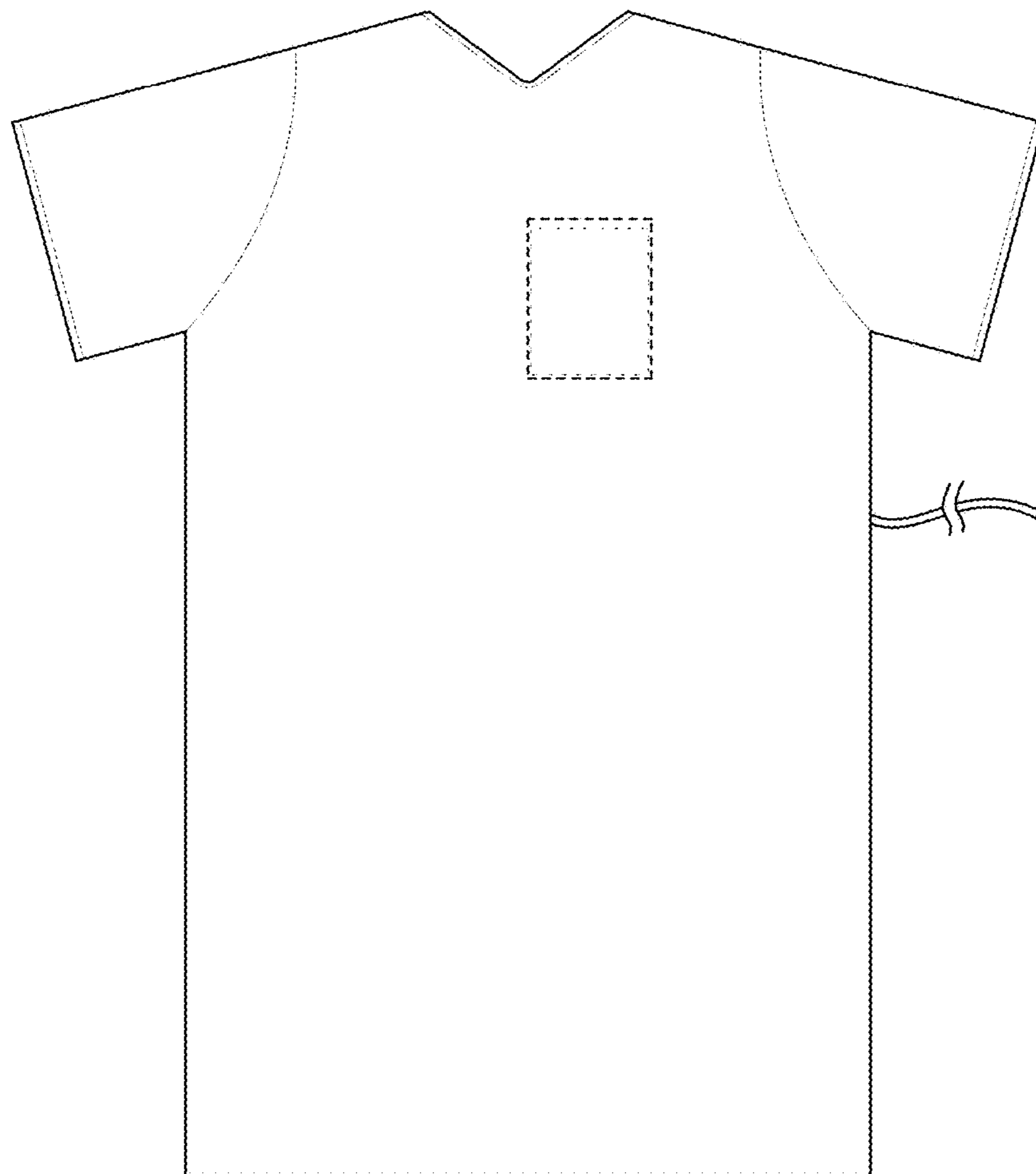

FIG. 11

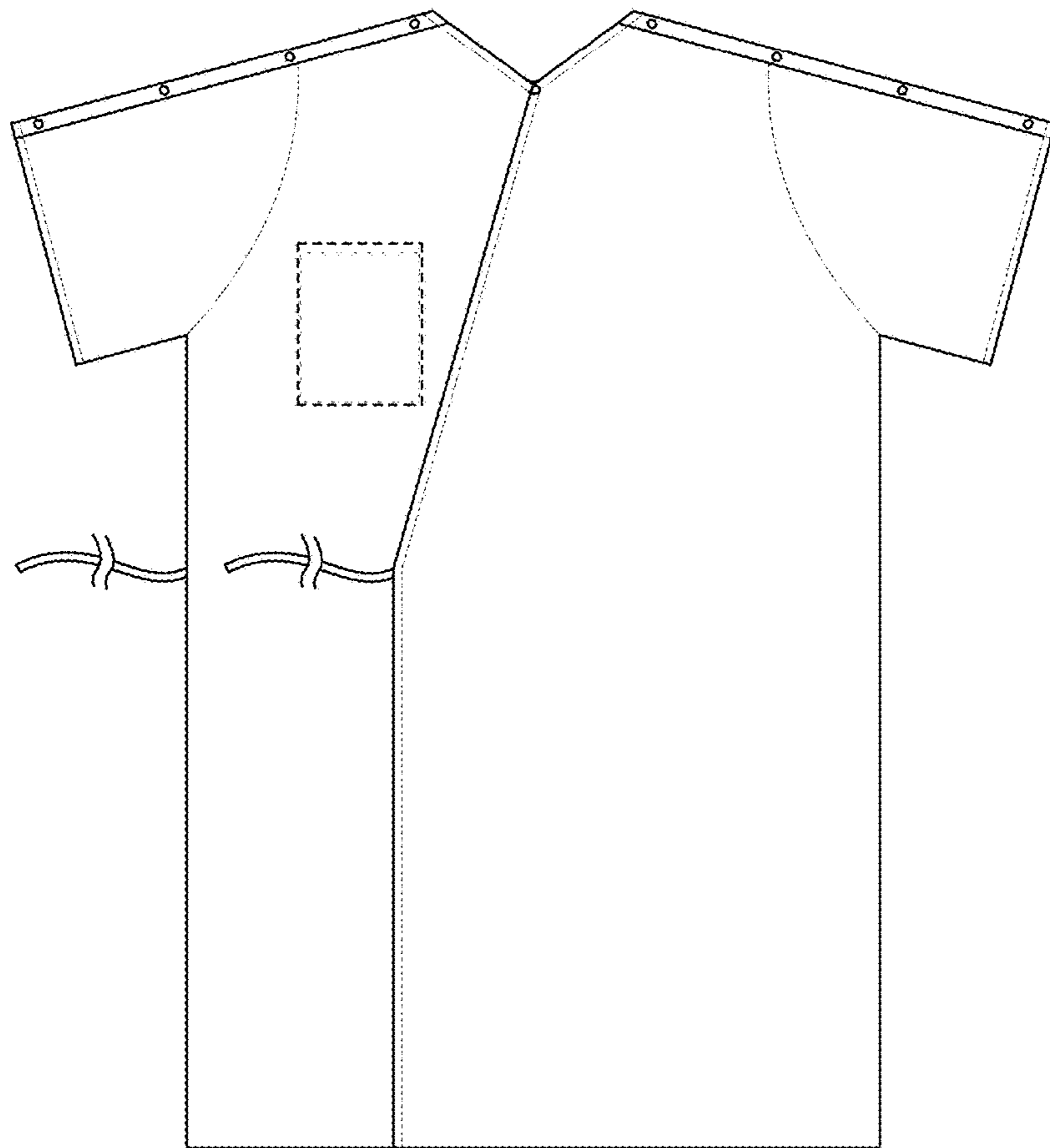

FIG. 12

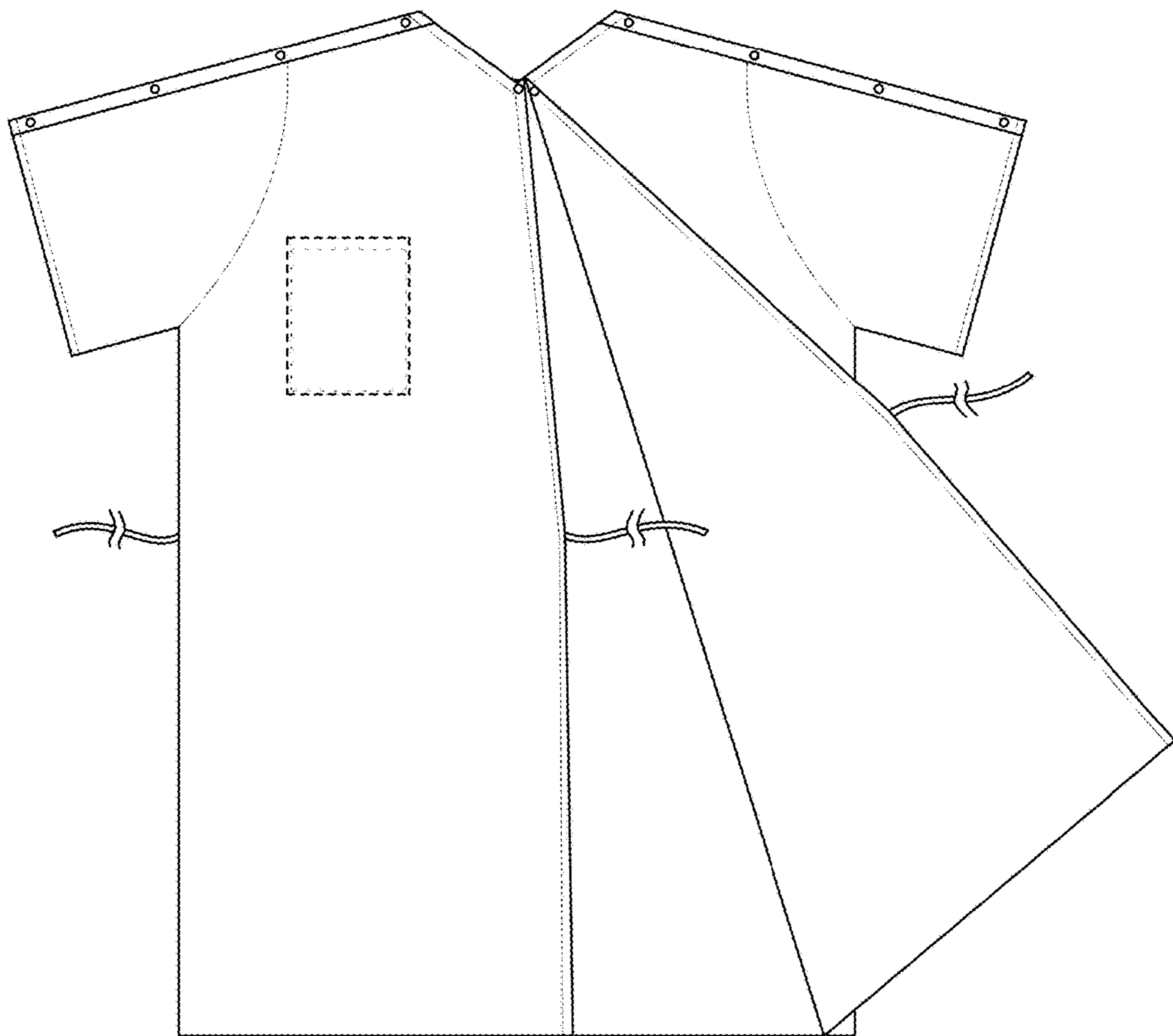

FIG. 13

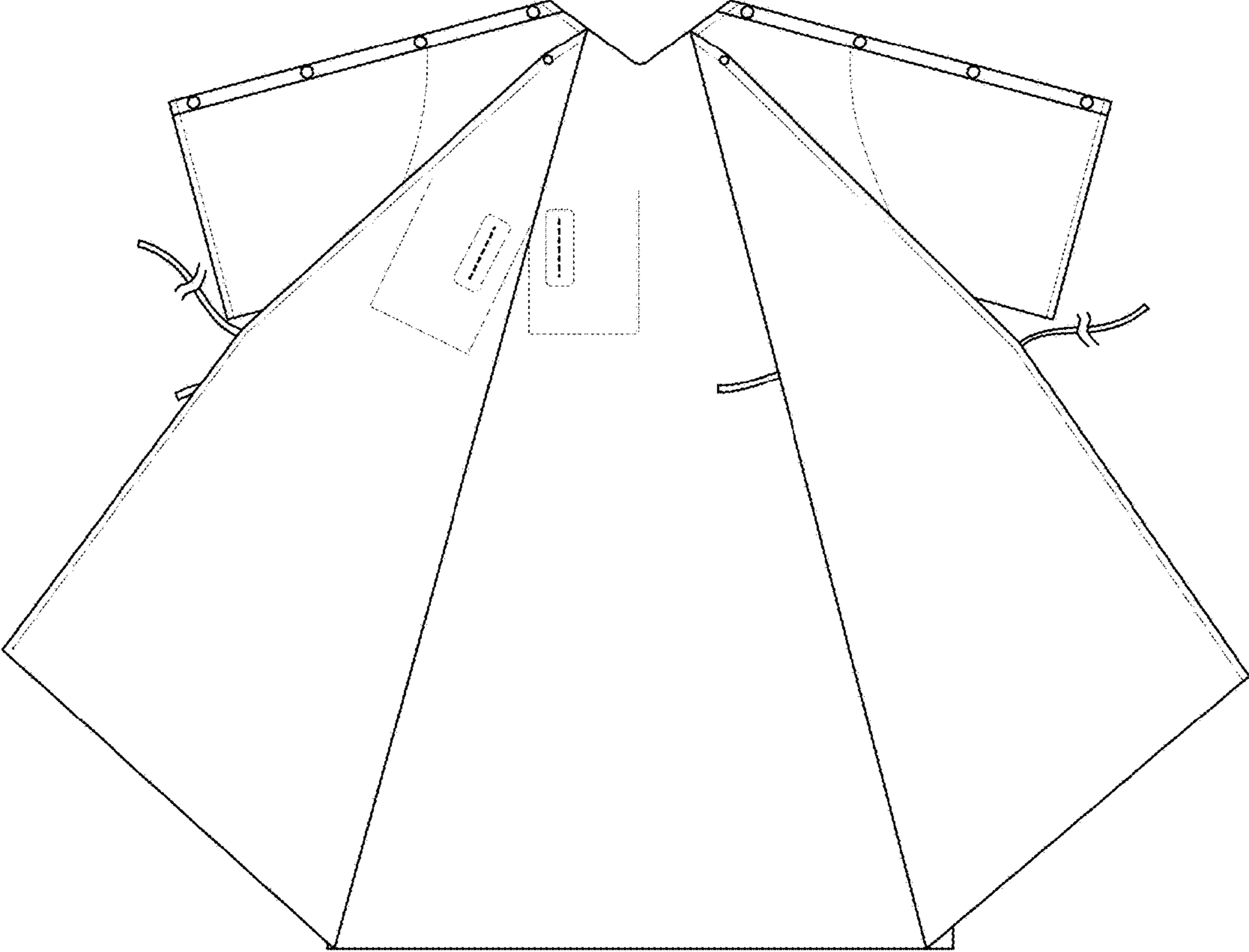

FIG. 14

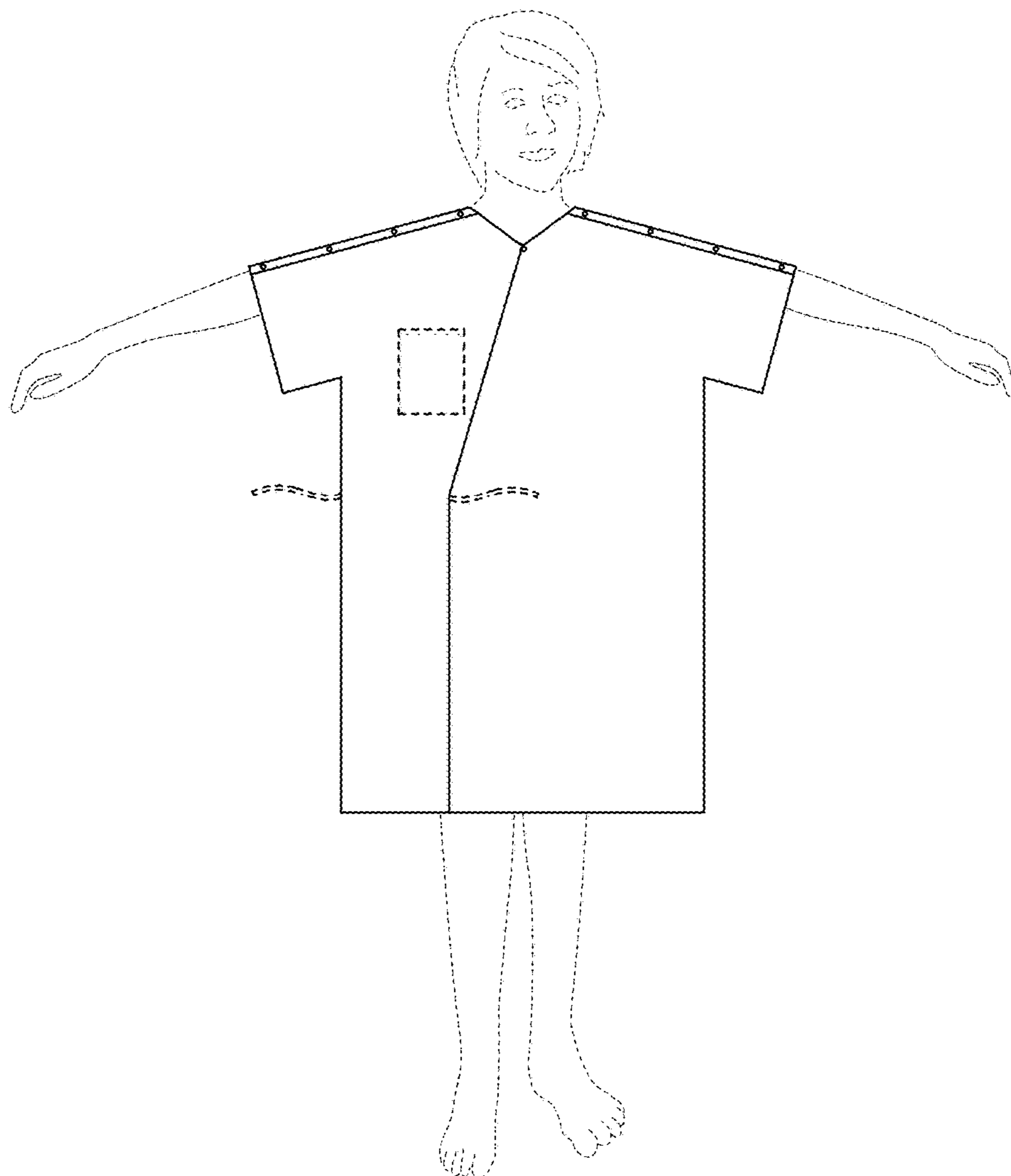

FIG. 15

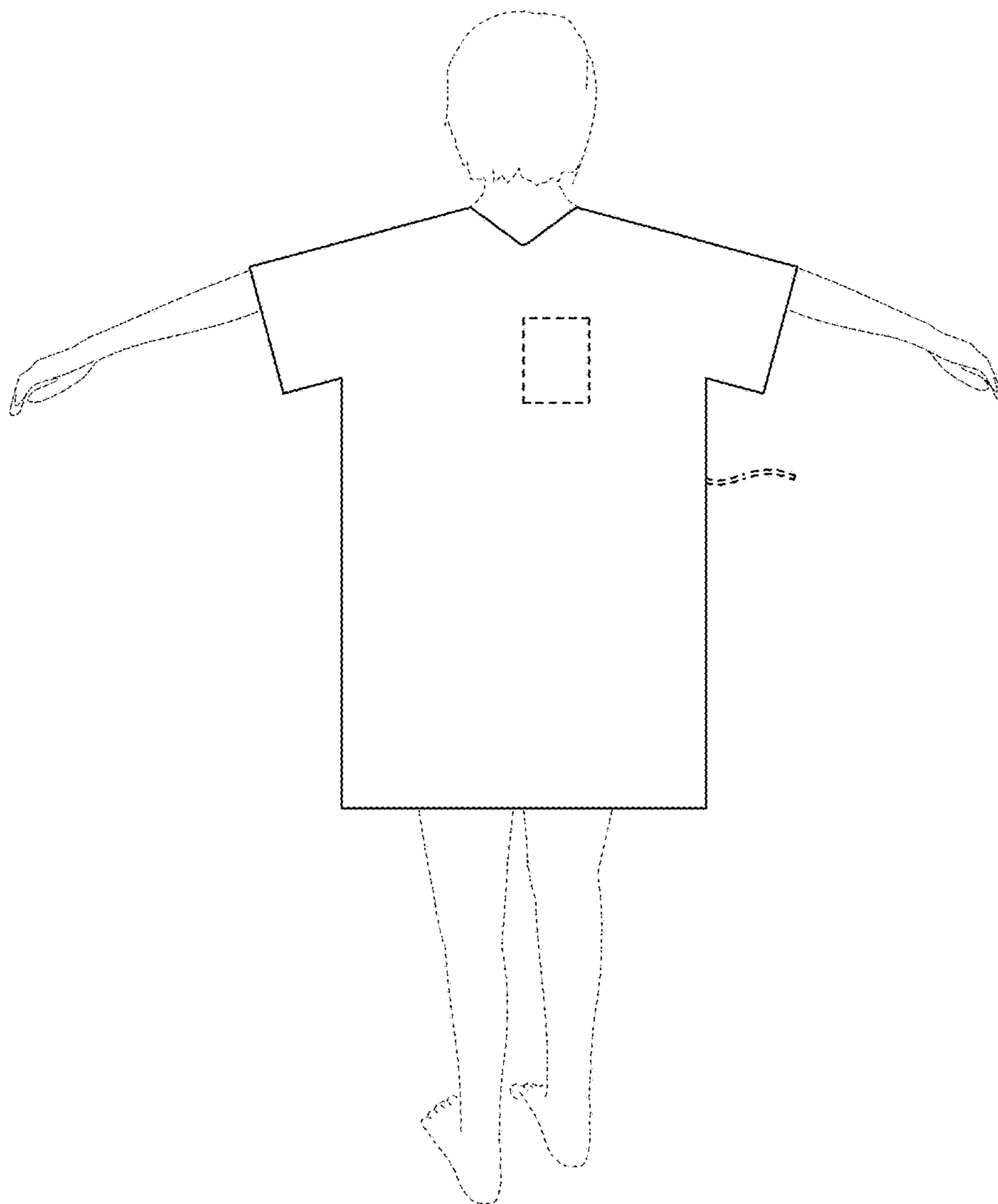

FIG. 16

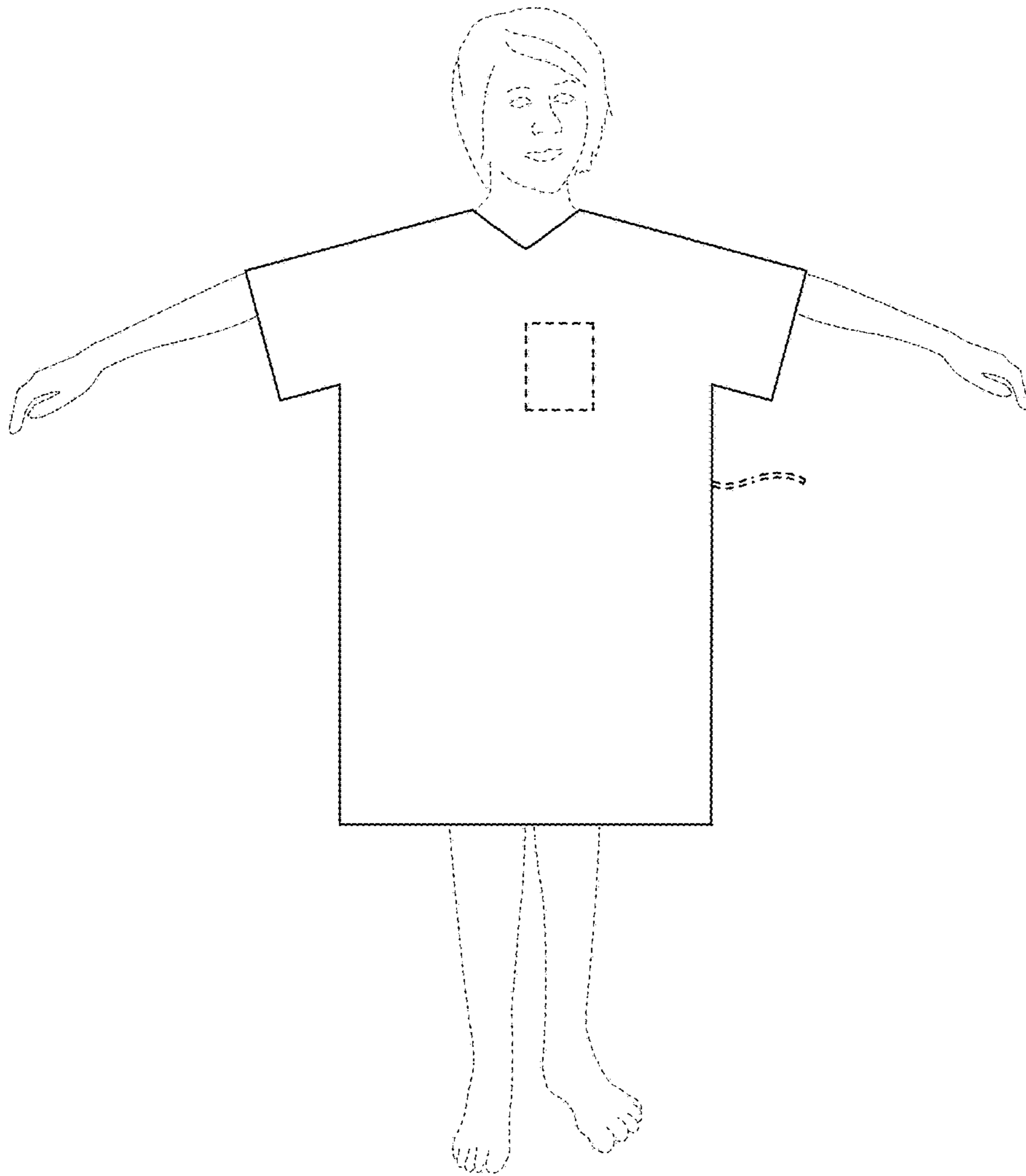

FIG. 17

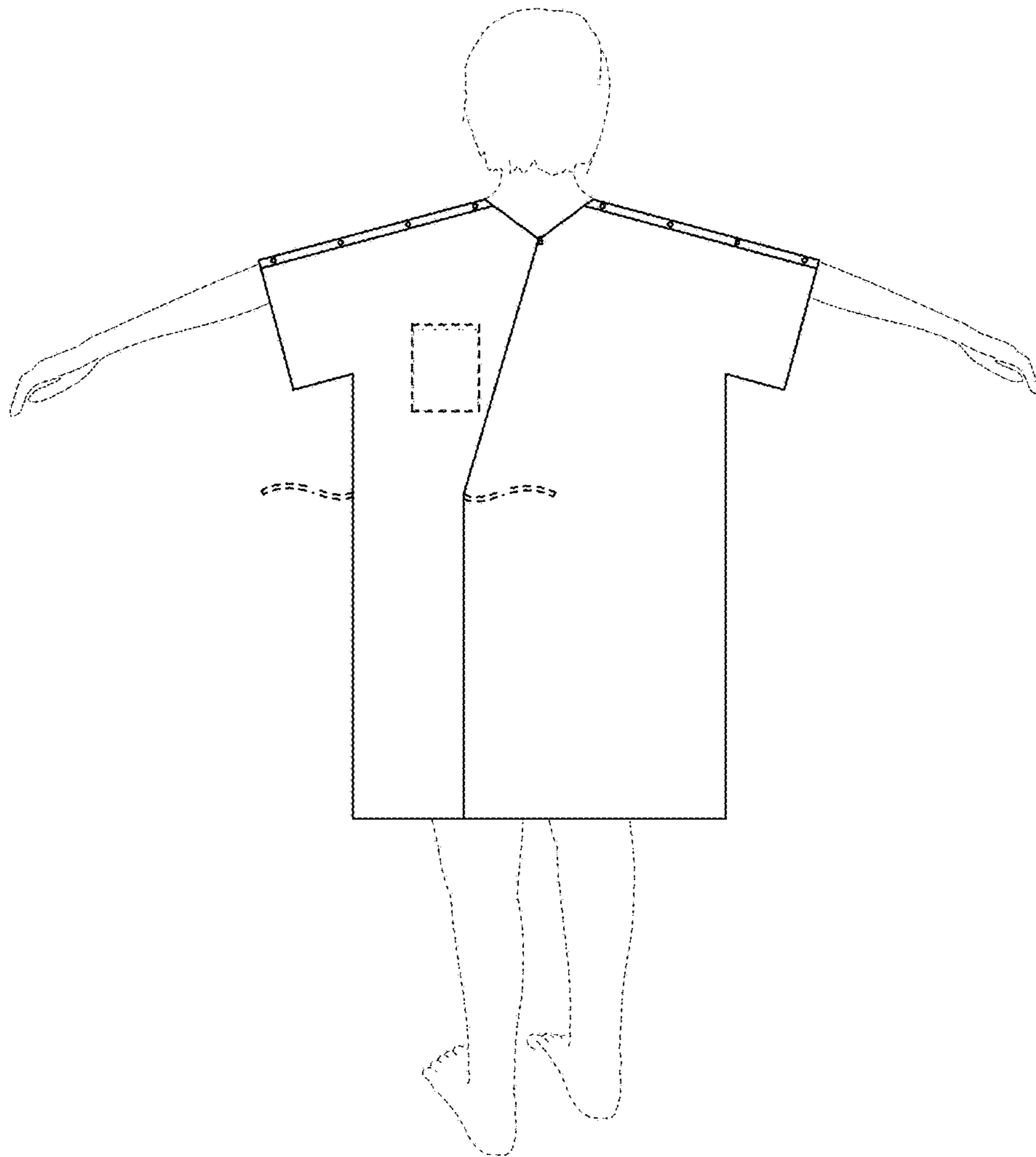

FIG. 18

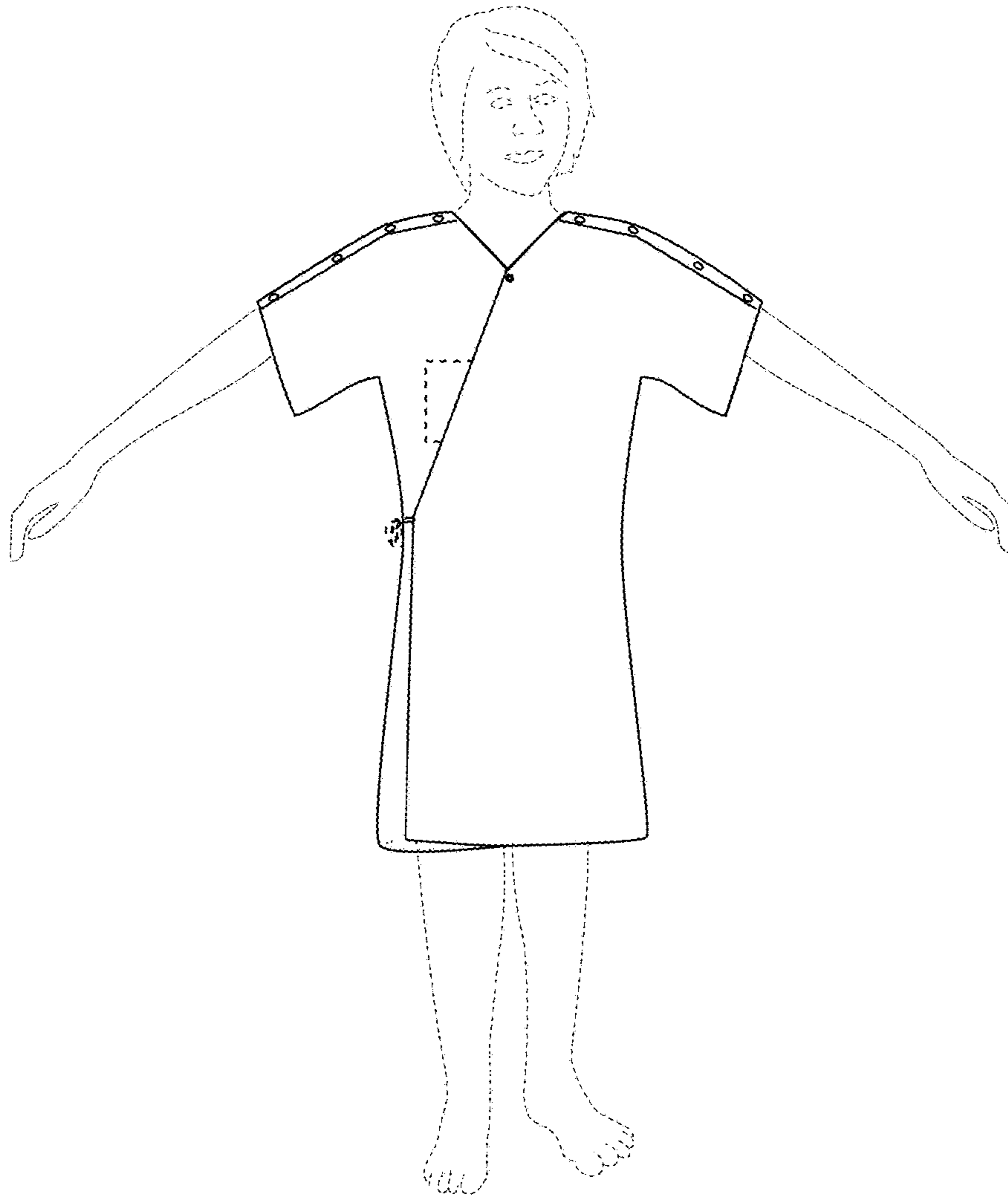

FIG. 19

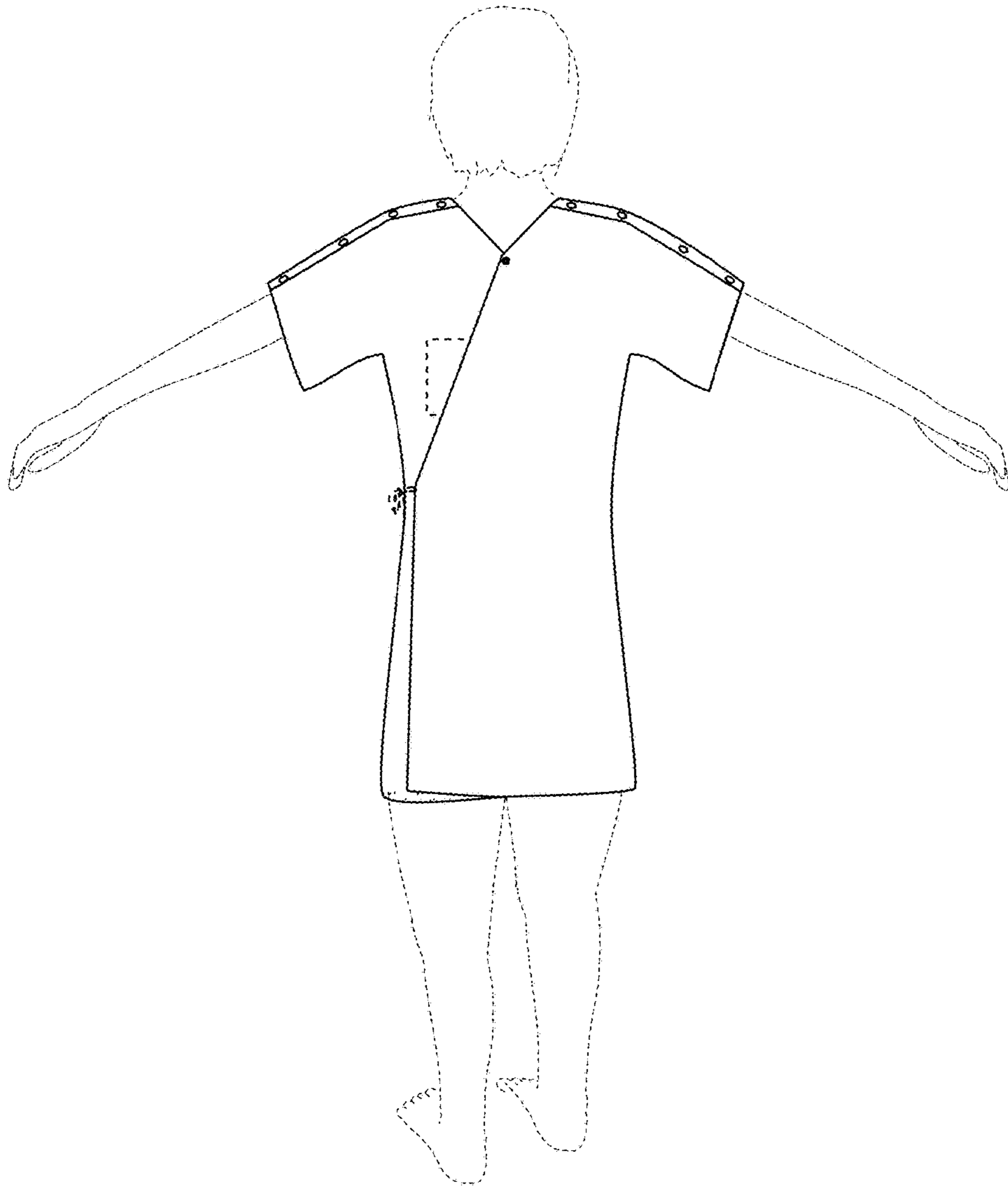

FIG. 20

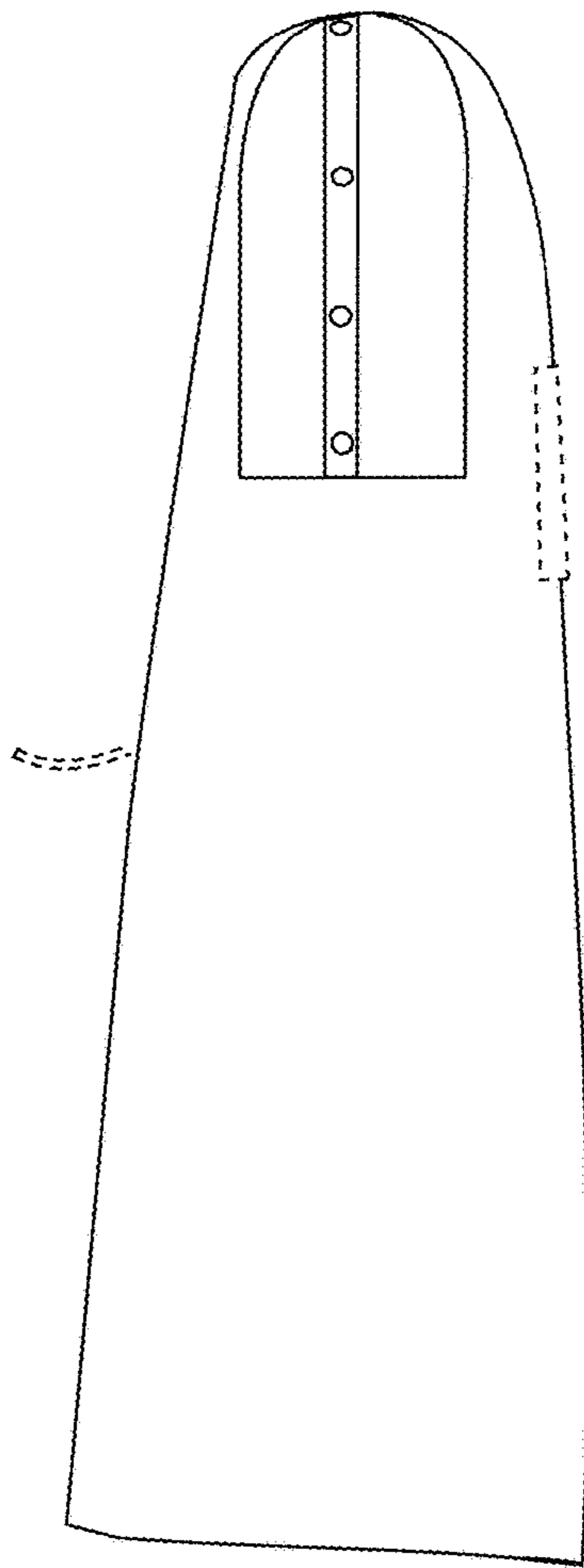

FIG. 21

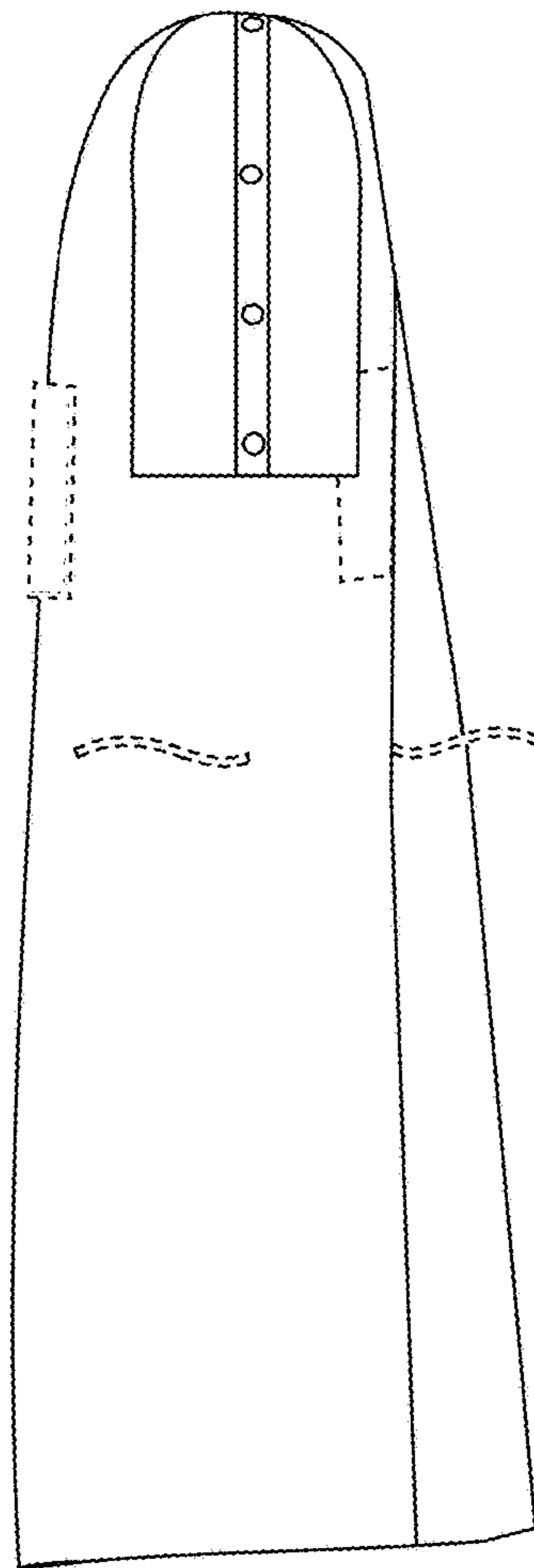

FIG. 22

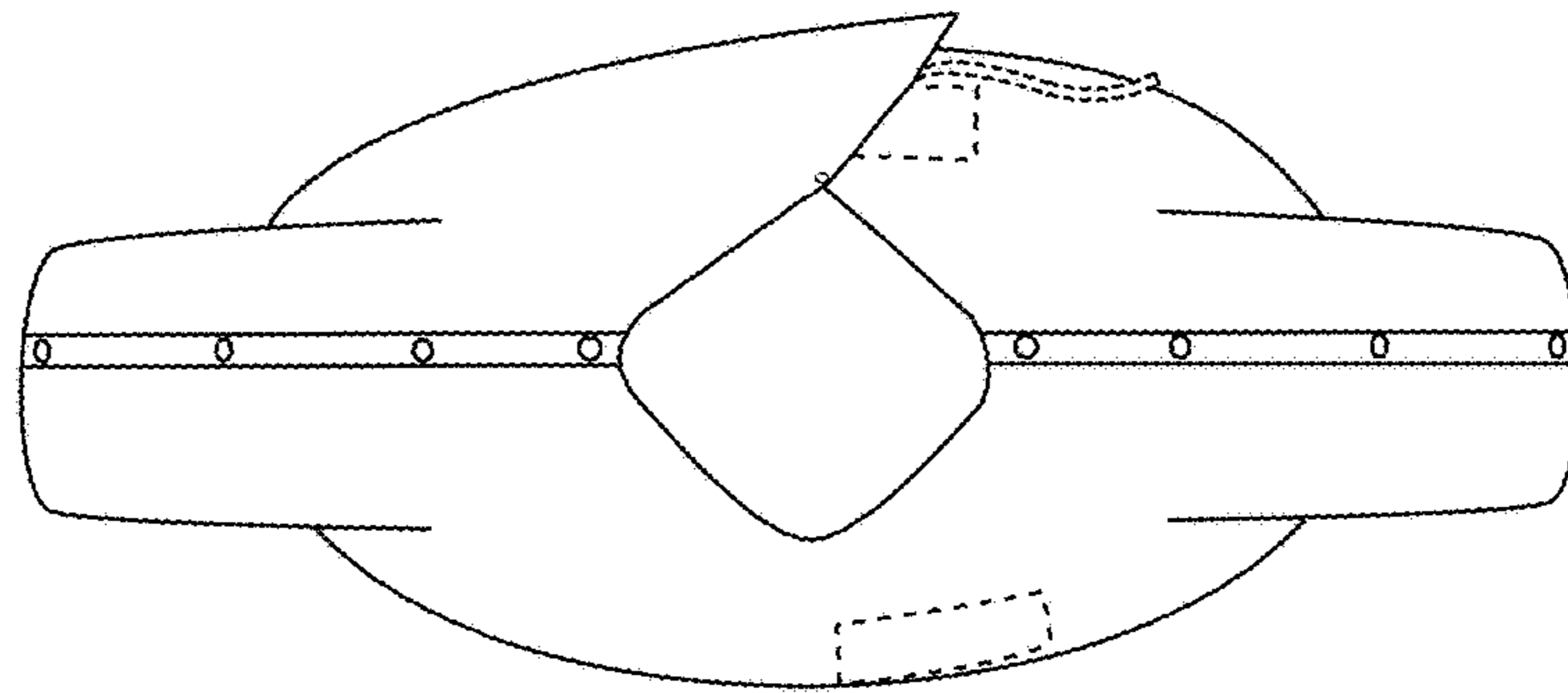

FIG. 23

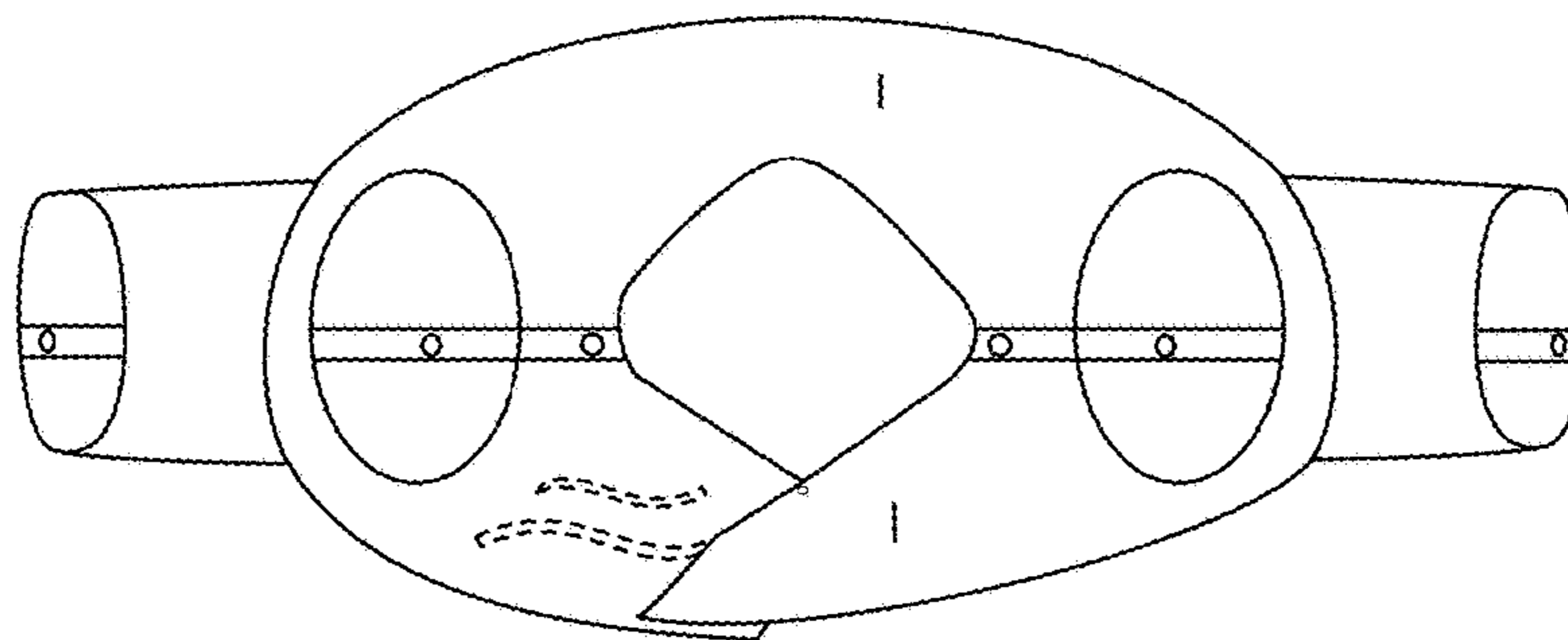

FIG. 24

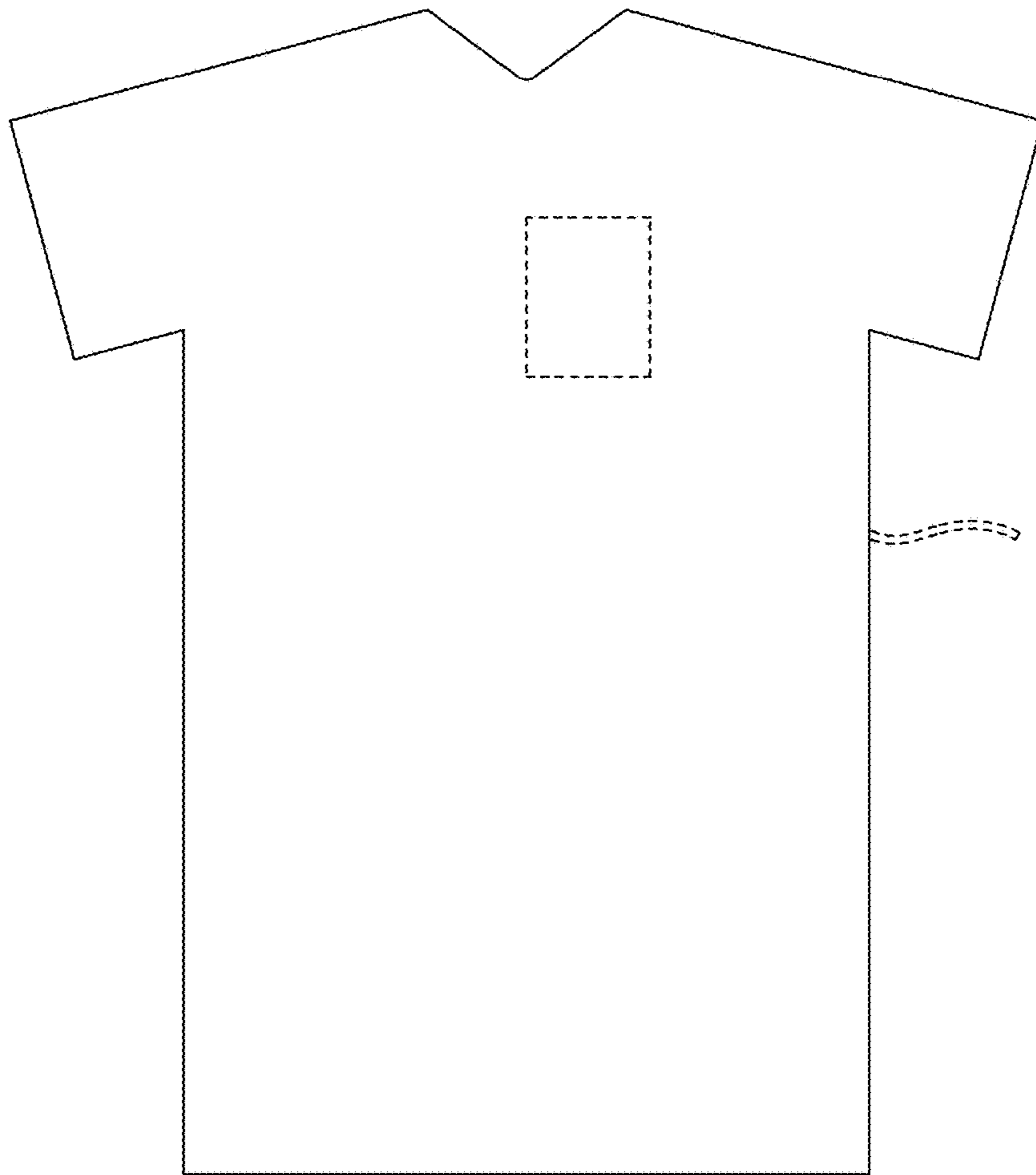

FIG. 25

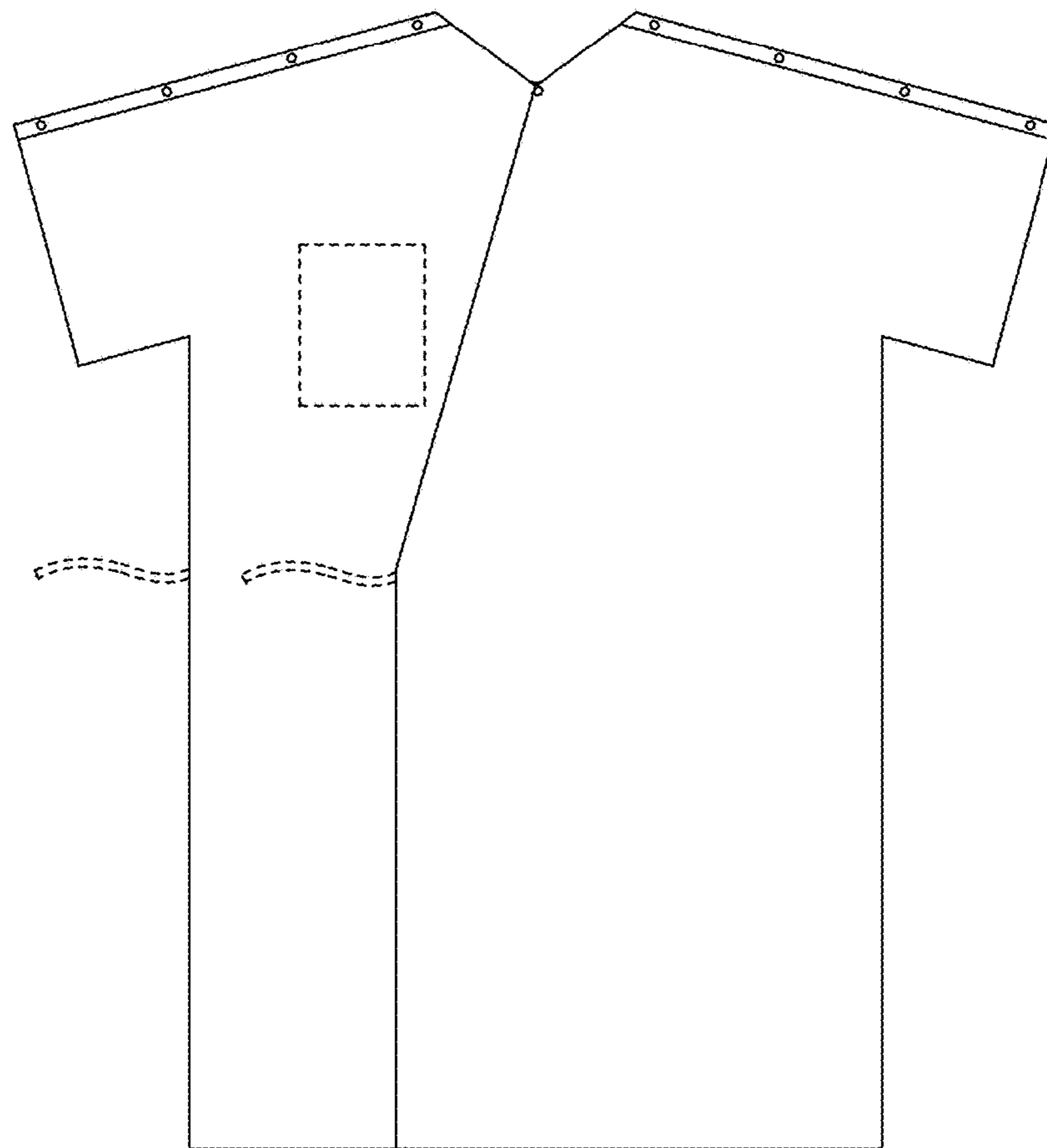

FIG. 26

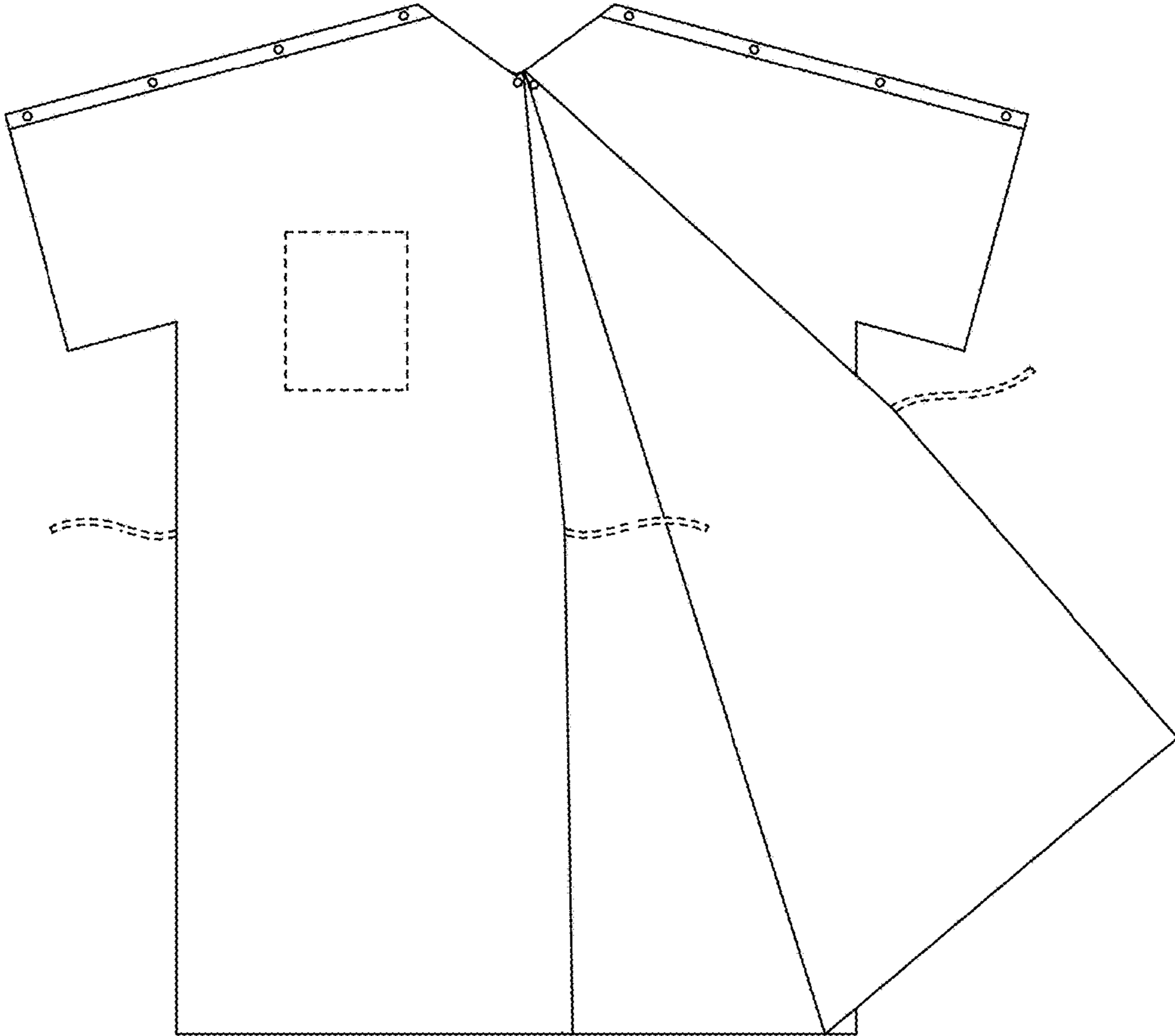

FIG. 27

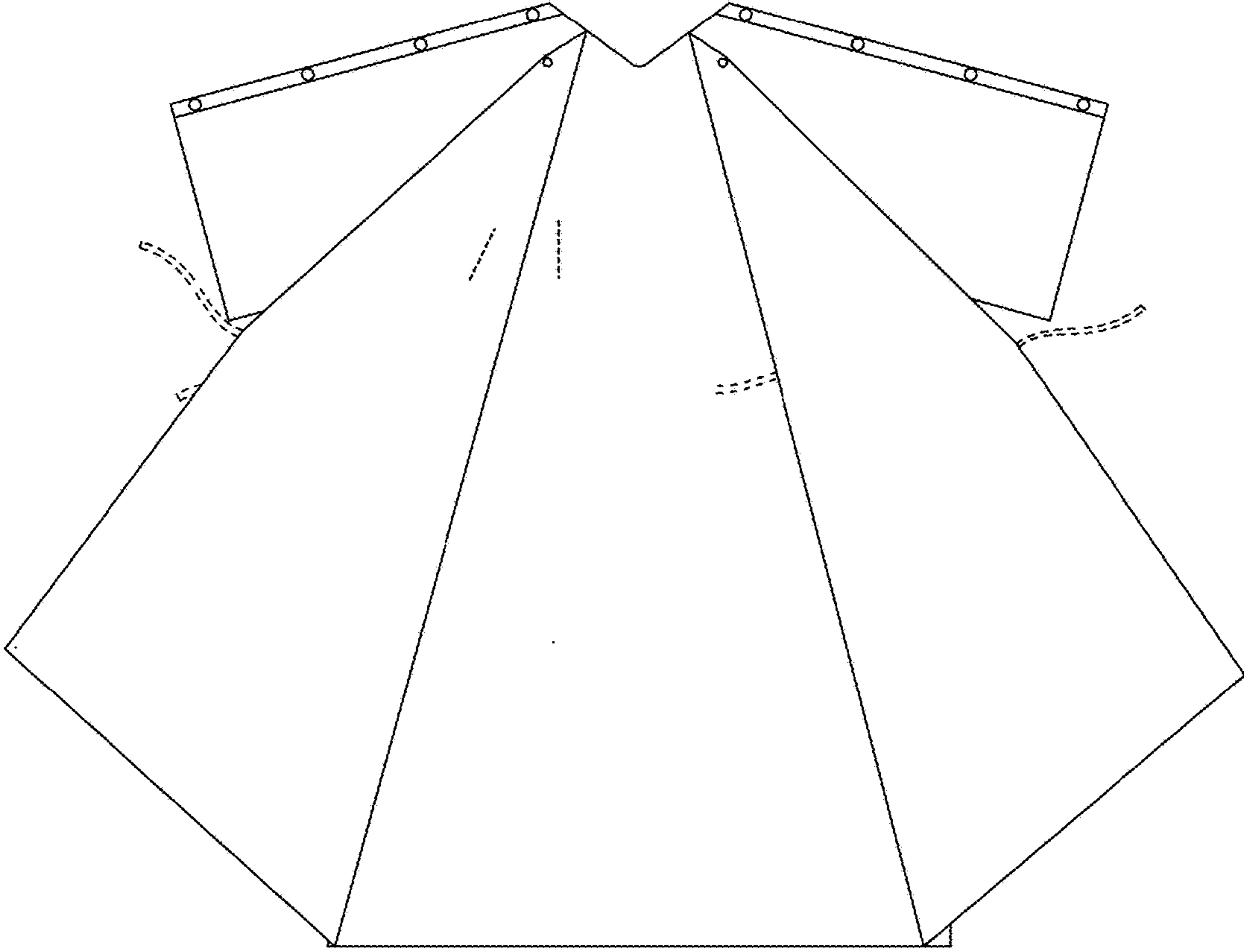

FIG. 28