



US00D857319S

(12) **United States Design Patent**
Chavana, Jr. et al.

(10) **Patent No.:** **US D857,319 S**

(45) **Date of Patent:** **** Aug. 20, 2019**

(54) **CLEANING FLUID TANK**

(71) Applicant: **Rug Doctor, LLC**, Plano, TX (US)

(72) Inventors: **Ernest Matthew Chavana, Jr.**, Villa Ridge, MO (US); **Richard Foster**, Powell, OH (US); **Stanley Anderson**, Fenton, MO (US); **Christopher Terpstra**, Frisco, TX (US); **Jan Valentic**, Plano, TX (US); **Xintao Ma**, Suzhou (CN)

(73) Assignee: **RUG DOCTOR, LLC**, Plano, TX (US)

(**) Term: **15 Years**

(21) Appl. No.: **29/625,427**

(22) Filed: **Nov. 9, 2017**

(51) **LOC (12) Cl.** **15-05**

(52) **U.S. Cl.**
USPC **D32/31**

(58) **Field of Classification Search**
USPC D32/15, 17, 18, 25, 31, 34, 39, 49, 51,
D32/52, 71, 72; 15/321

(Continued)

(56) **References Cited**

U.S. PATENT DOCUMENTS

D190,626 S * 6/1961 Musichuk D32/30
D211,893 S * 8/1968 Gantz D32/30

(Continued)

OTHER PUBLICATIONS

Flex Clean posted by Rug Doctor posted date unknown, © HomeDepot, [online], [site visited Nov. 29, 2018]. Available from Internet, <https://www.homedepot.com/p/Rug-Doctor-FlexClean-Upright->

Carpet-and-Hard-Floor-Cleaner-with-9-oz-All-In-One-Multi-Surface-Cleaning-Solution-93196/304364206 (Year: 2018).*

(Continued)

Primary Examiner — Cynthia Ramirez

Assistant Examiner — Laura H Yu

(74) *Attorney, Agent, or Firm* — Hauptman Ham, LLP

(57) **CLAIM**

The ornamental design for a cleaning fluid tank, as shown and described.

DESCRIPTION

FIG. 1 is a perspective view of a first embodiment of a cleaning fluid tank showing our new design; FIG. 2 is a front view of the cleaning fluid tank of FIG. 1; FIG. 3 is a rear view of the cleaning fluid tank of FIG. 1; FIG. 4 is a left side view of the cleaning fluid tank of FIG. 1; FIG. 5 is a right side view of the cleaning fluid tank of FIG. 1; FIG. 6 is a top view of the cleaning fluid tank of FIG. 1; FIG. 7 is a bottom view of the cleaning fluid tank of FIG. 1; FIG. 8 is a perspective view of a second embodiment of a cleaning fluid tank showing our new design; FIG. 9 is a front view of the cleaning fluid tank of FIG. 8; FIG. 10 is a rear view of the cleaning fluid tank of FIG. 8; FIG. 11 is a left side view of the cleaning fluid tank of FIG. 8; FIG. 12 is a right side view of the cleaning fluid tank of FIG. 8; FIG. 13 is a top view of the cleaning fluid tank of FIG. 8; and, FIG. 14 is a bottom view of the cleaning fluid tank of FIG. 8. The broken lines in the drawings show portions of the cleaning fluid tank that form no part of the claimed design.

1 Claim, 14 Drawing Sheets

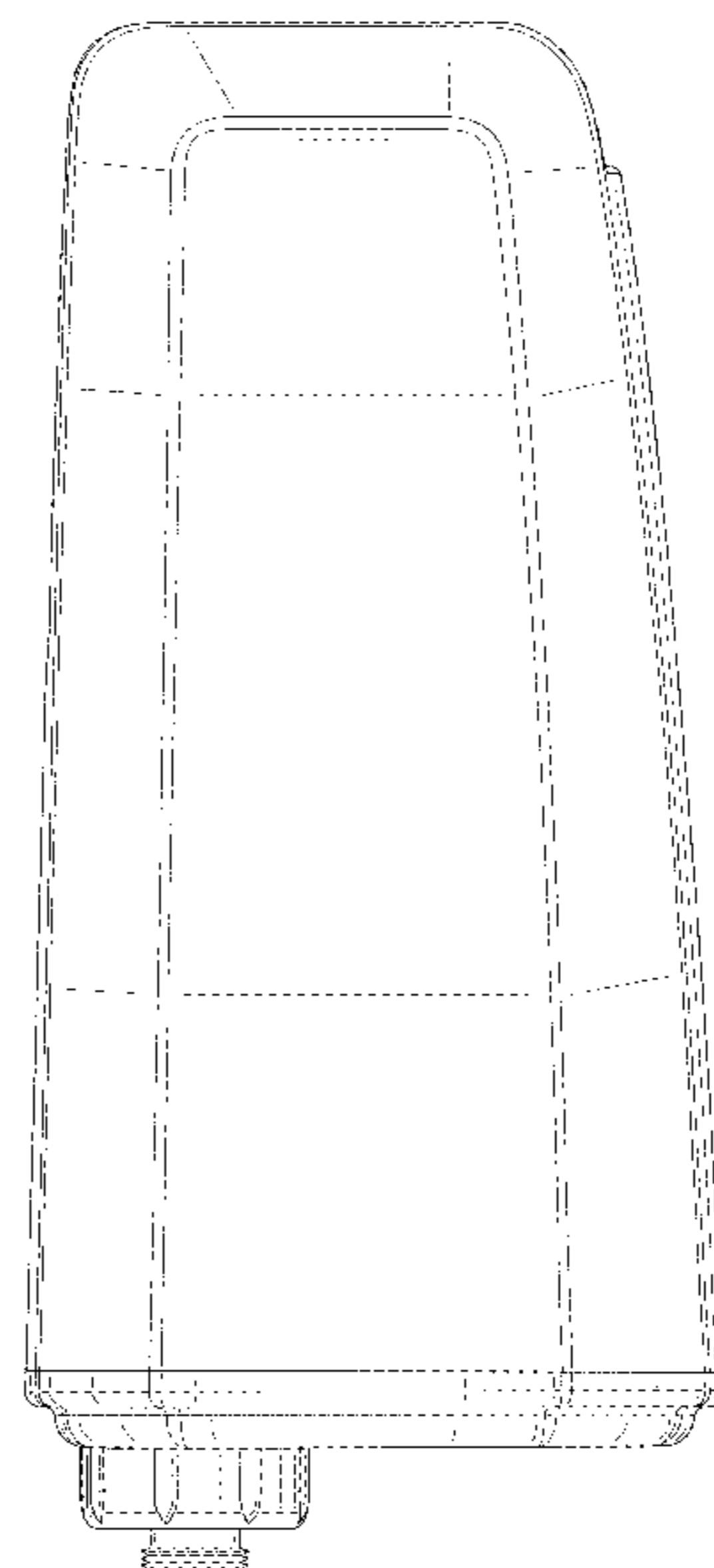
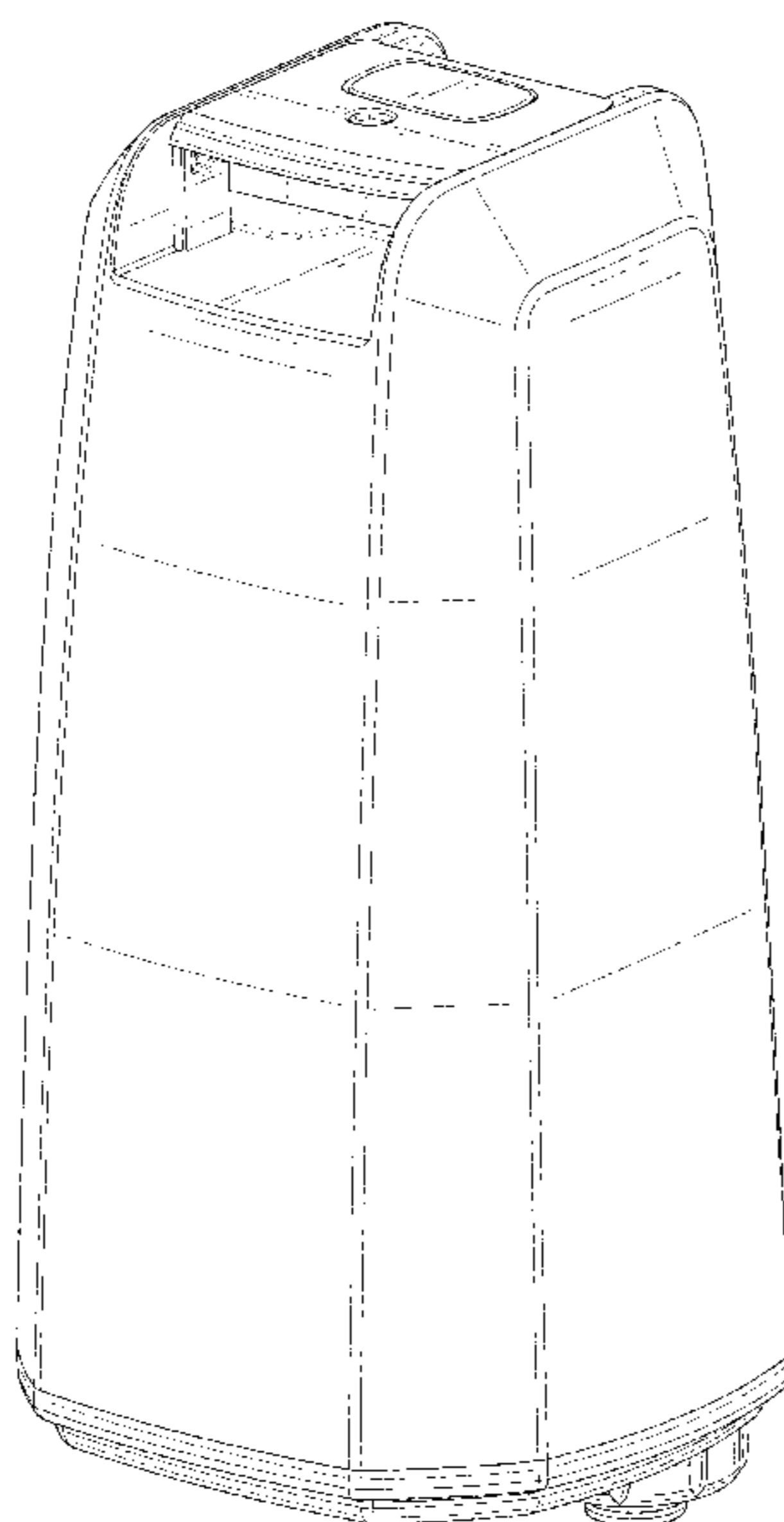

(58) **Field of Classification Search**

CPC A47L 11/4088; A47L 11/4075; A47L
11/4002; A47L 11/4044; A47L 11/4072;
A47L 11/4008; A47L 11/4036; A47L
11/201; A47L 11/202; A47L 11/307;
A47L 11/34

See application file for complete search history.

D739,099 S * 9/2015 Tatic D32/15
D739,100 S * 9/2015 Tatic D32/15
D778,016 S * 1/2017 Miller D32/31
2016/0106288 A1* 4/2016 Hess A47L 11/4008
134/18

OTHER PUBLICATIONS

(56)

References Cited

U.S. PATENT DOCUMENTS

D214,811 S * 7/1969 Gaudry D32/30
D365,179 S * 12/1995 Bradd D32/31
5,615,448 A * 4/1997 Crouser A47L 5/32
15/321
D420,474 S * 2/2000 Auburn D32/17
D439,381 S * 3/2001 Saunders D32/31
D460,229 S * 7/2002 Zahuranec D32/22
D576,703 S * 9/2008 Nathan D23/225

Hoover Steam Vac posted by VacBin posted date Jun. 7, 2013, ©
Youtube, [online], [site visited Nov. 29, 2018]. Available from
Internet, https://www.youtube.com/watch?time_continue=58&v=fmRRrJjfF54 (Year: 2013).*

Hoover Power Scrub posted by Hoover posted review date Apr. 10,
2017, © Walmart, [online], [site visited Nov. 29, 2018]. Available
from Internet, <https://www.walmart.com/ip/Hoover-Power-Scrub-Carpet-Cleaner-w-SpinScrub-Technology-FH50135/129079808> (Year:
2017).*

* cited by examiner

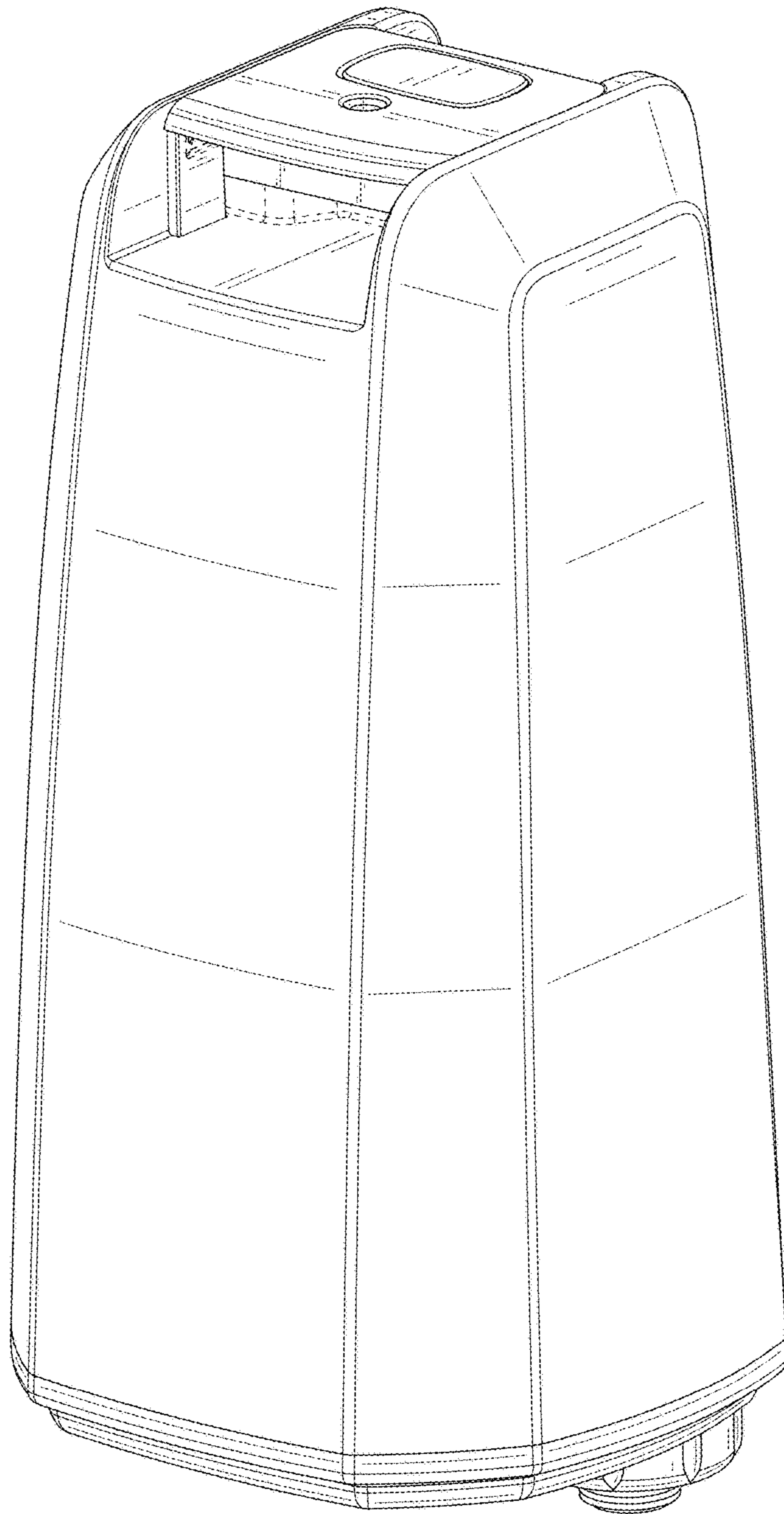

FIG. 1

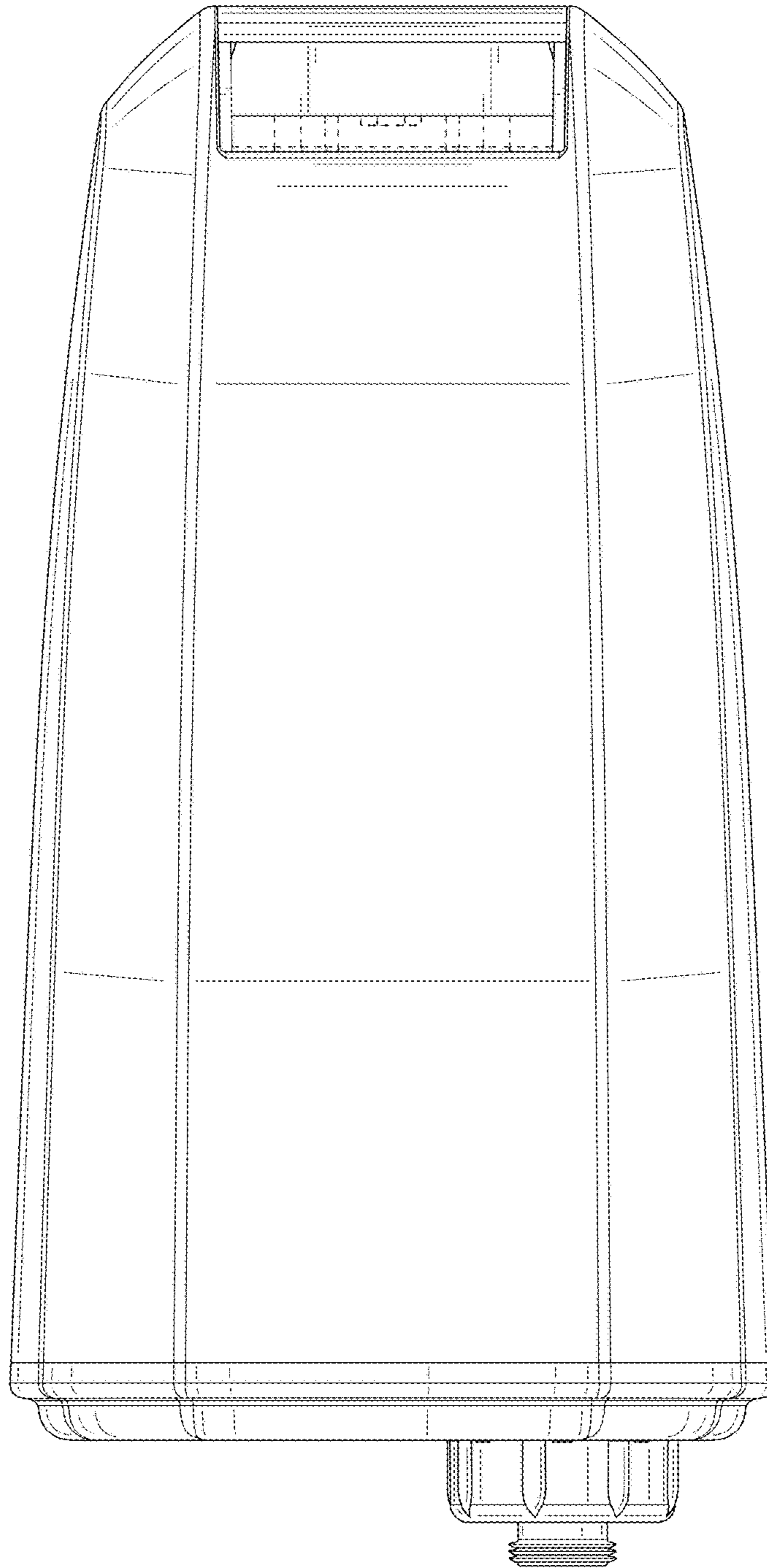

FIG. 2

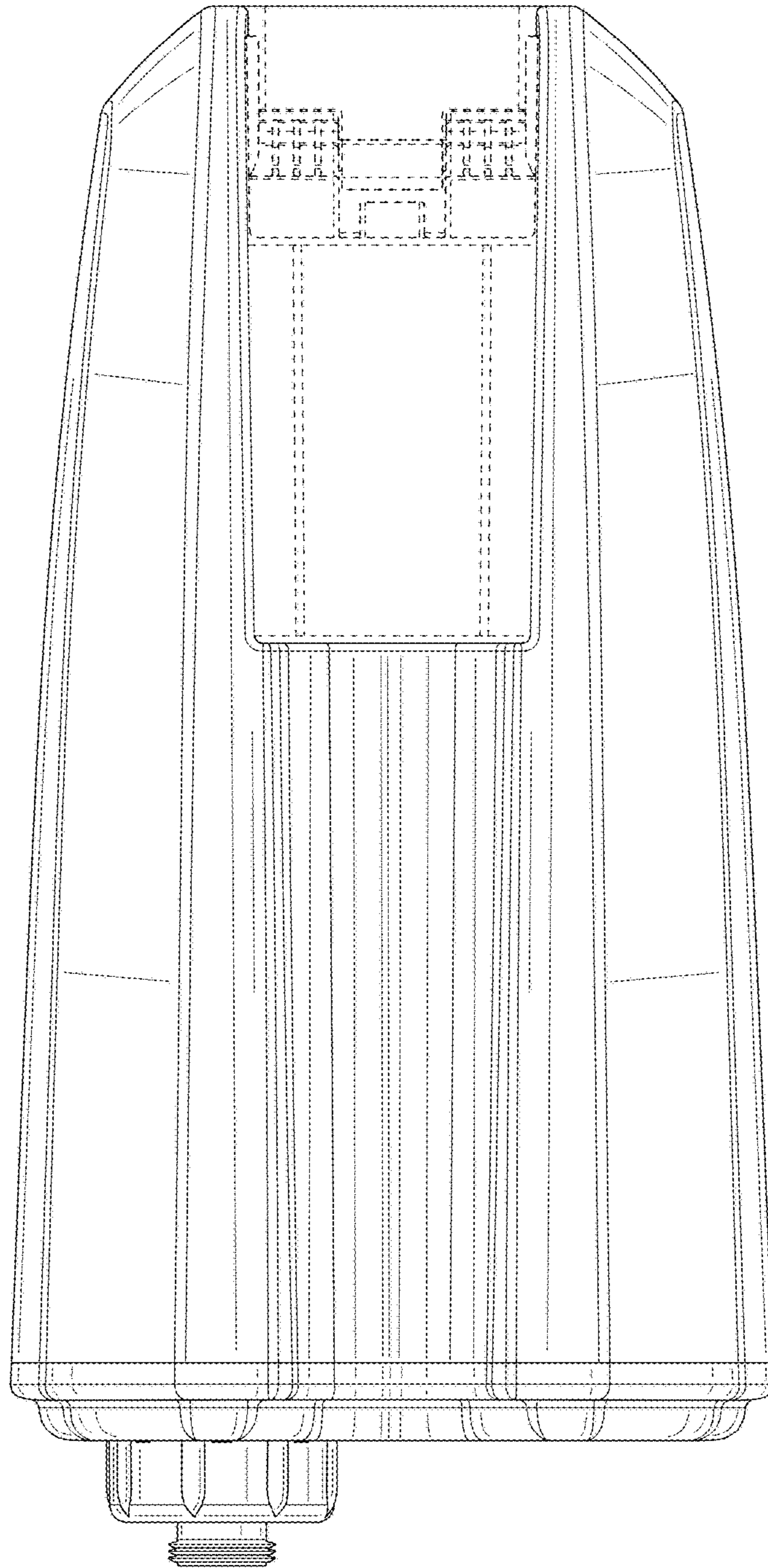

FIG. 3

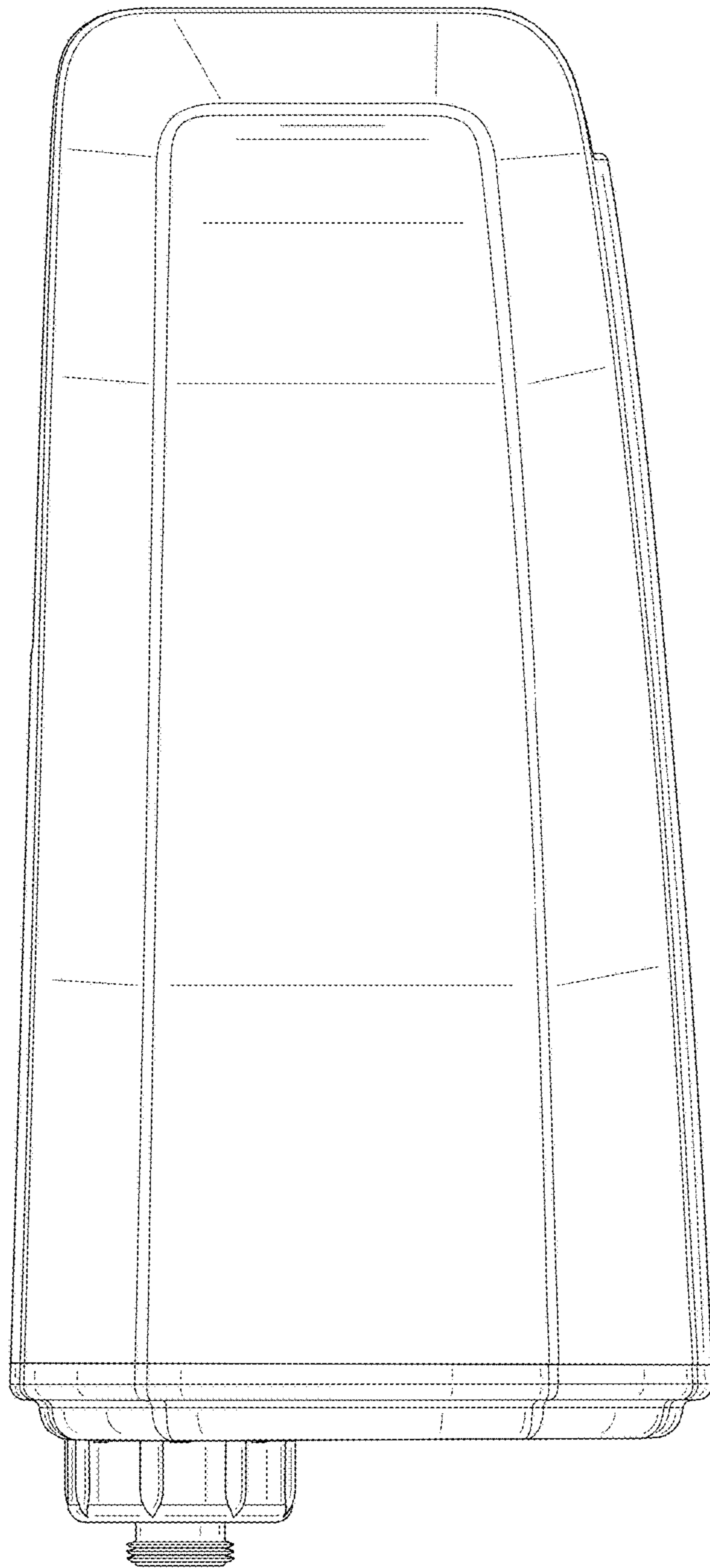

FIG. 4

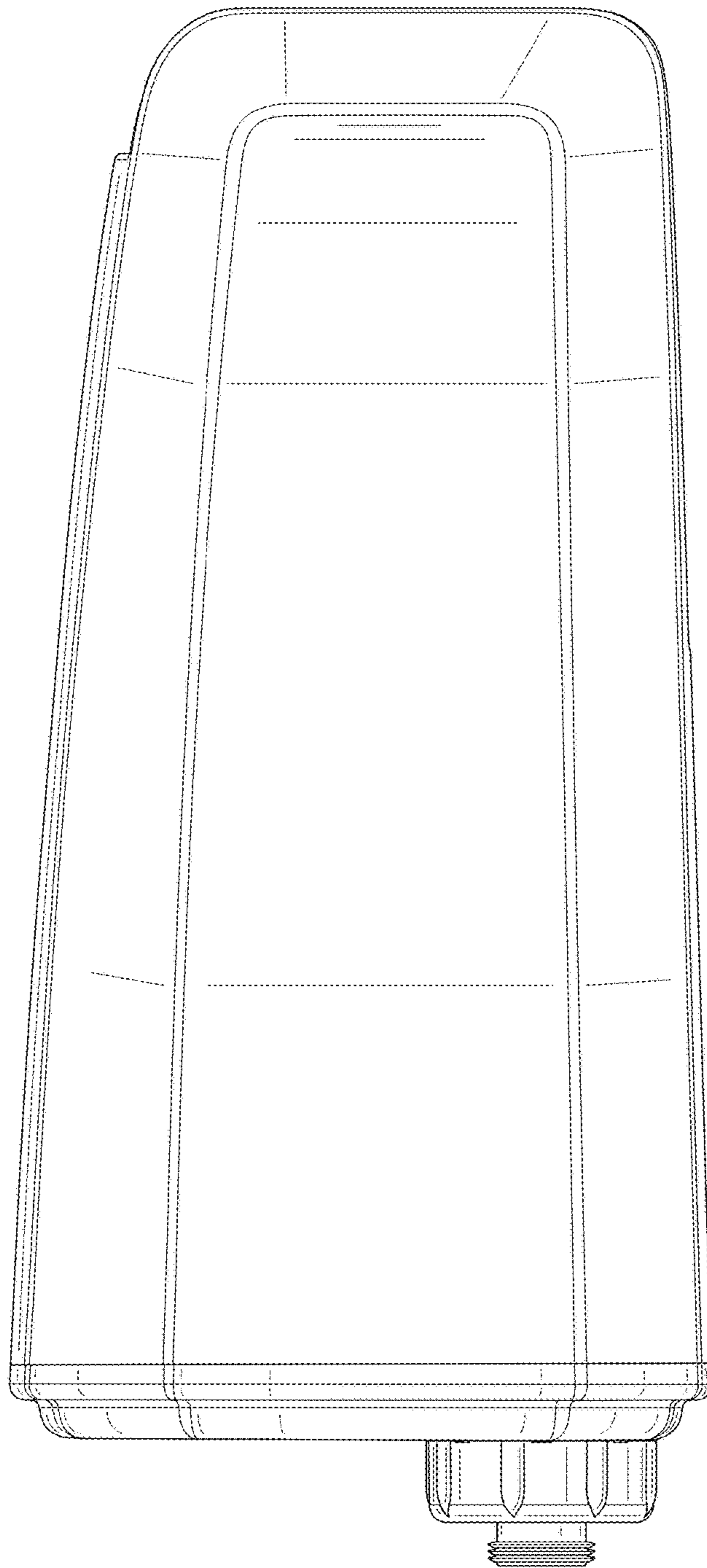

FIG. 5

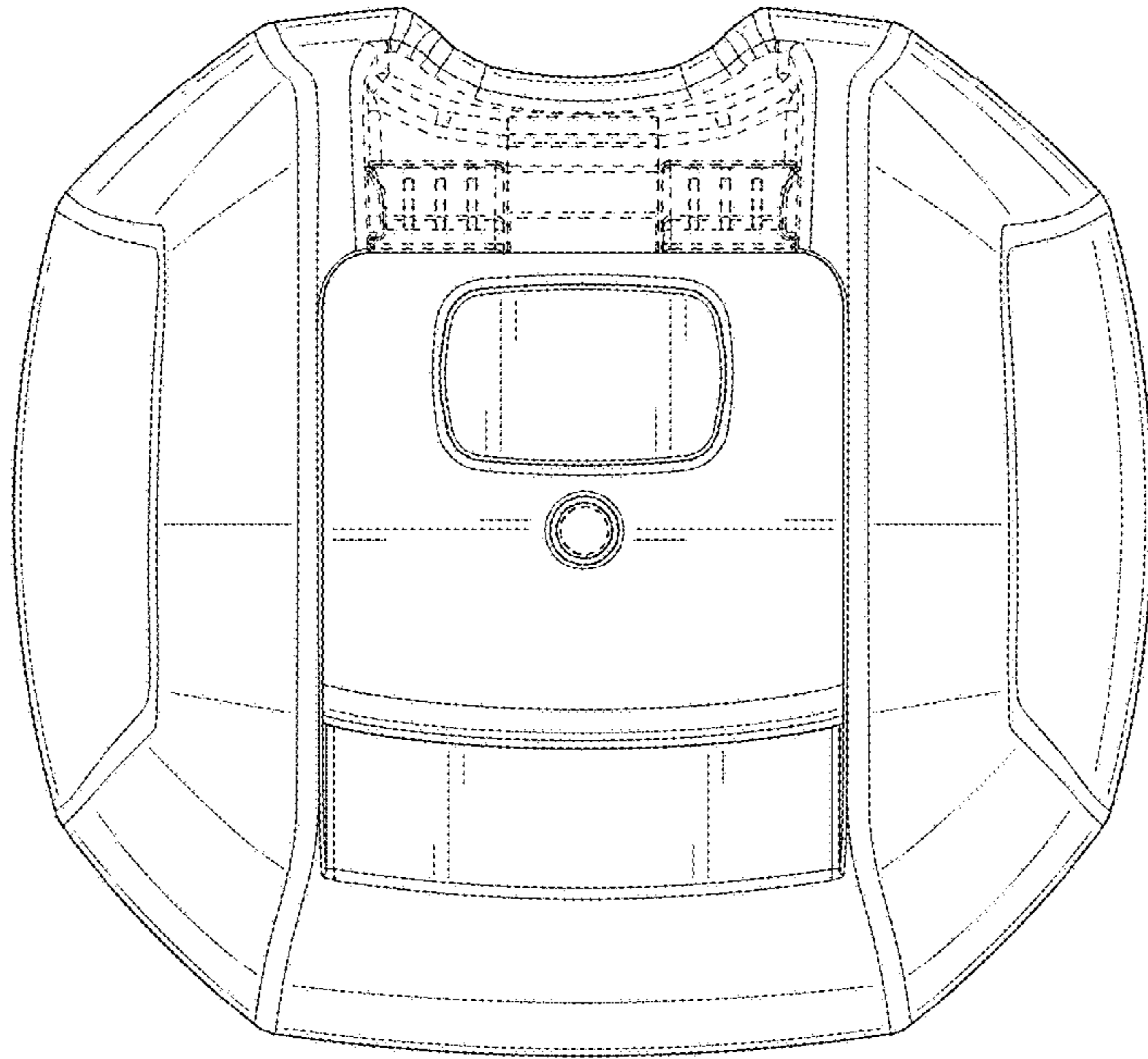

FIG. 6

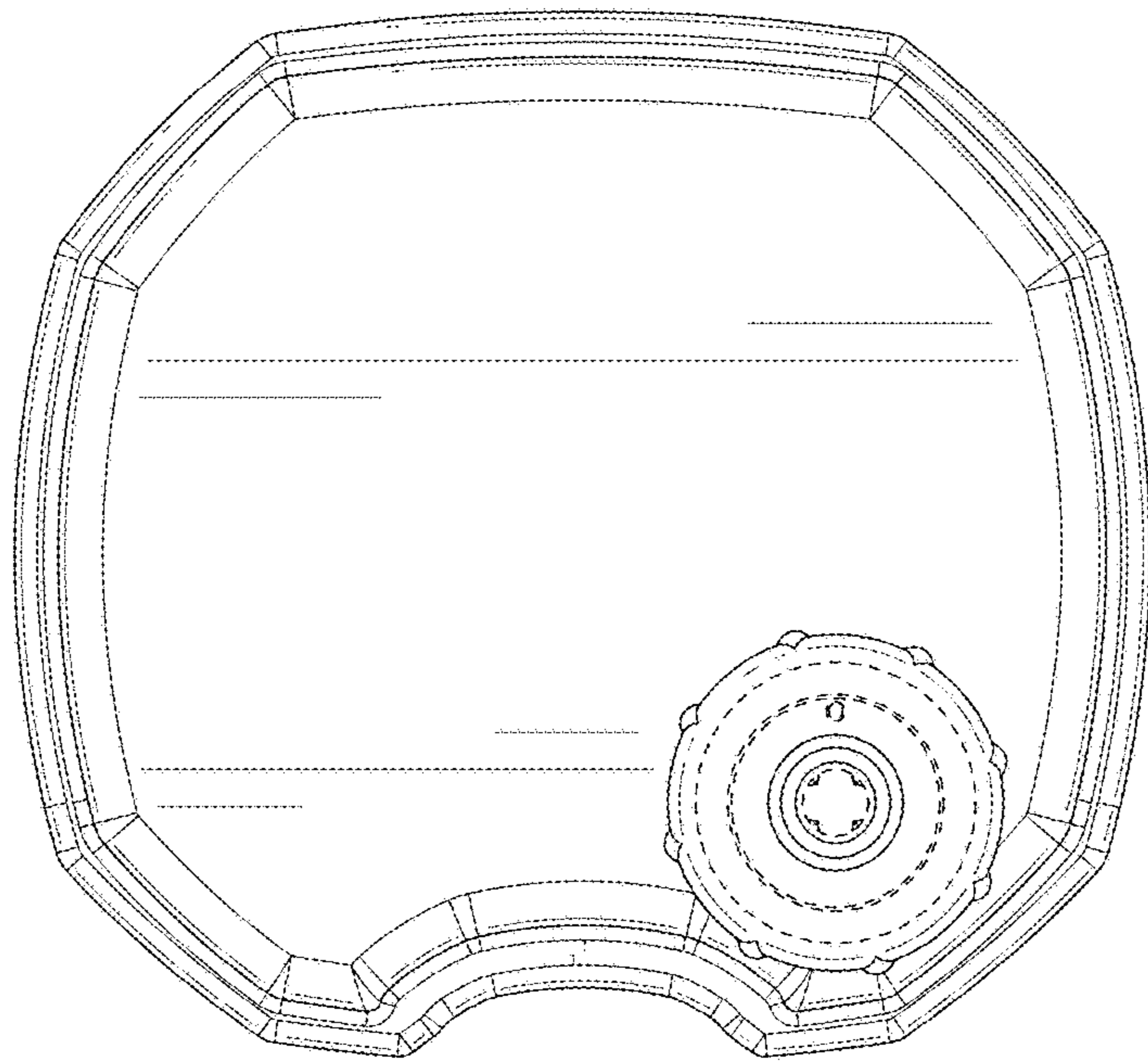

FIG. 7

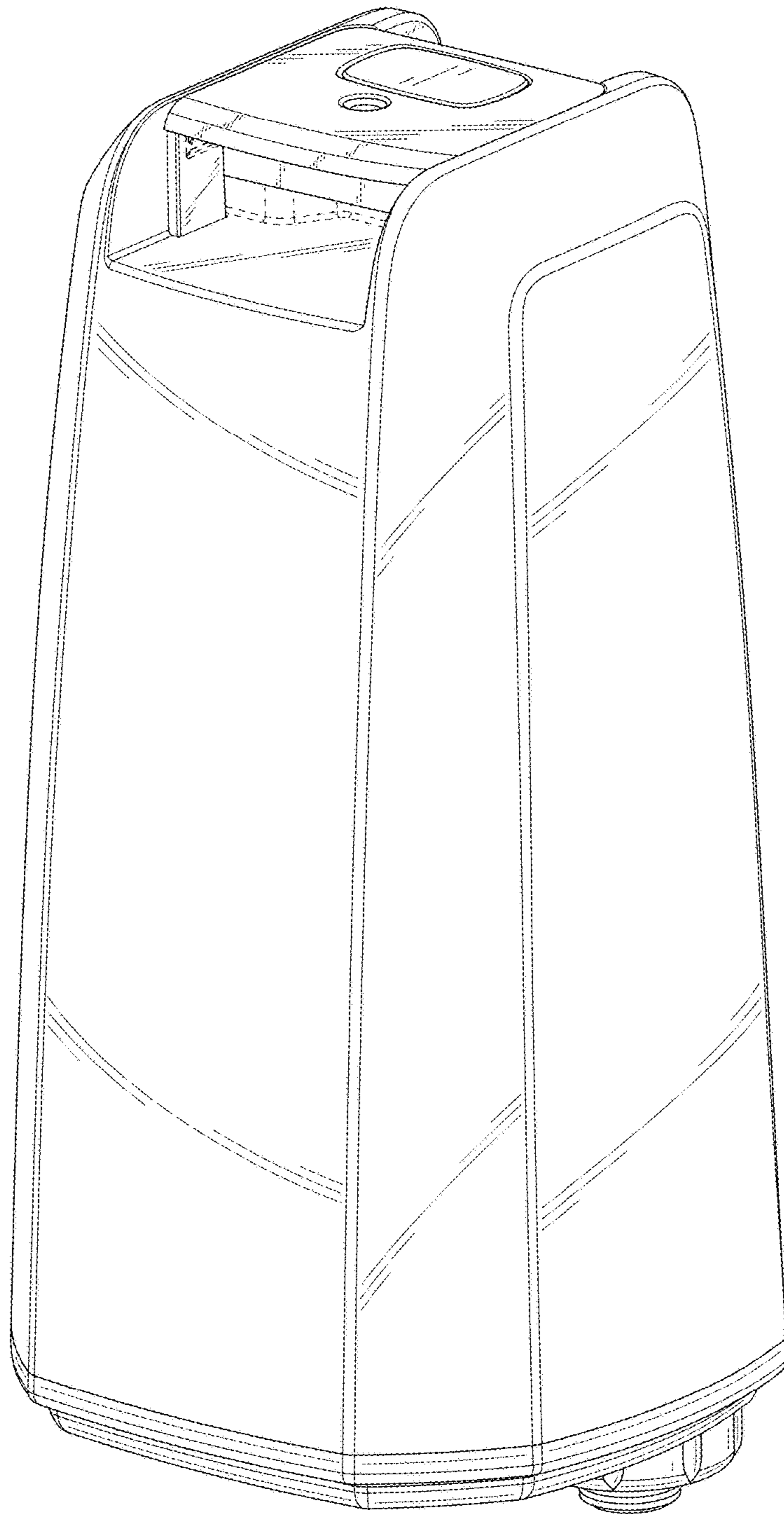

FIG. 8

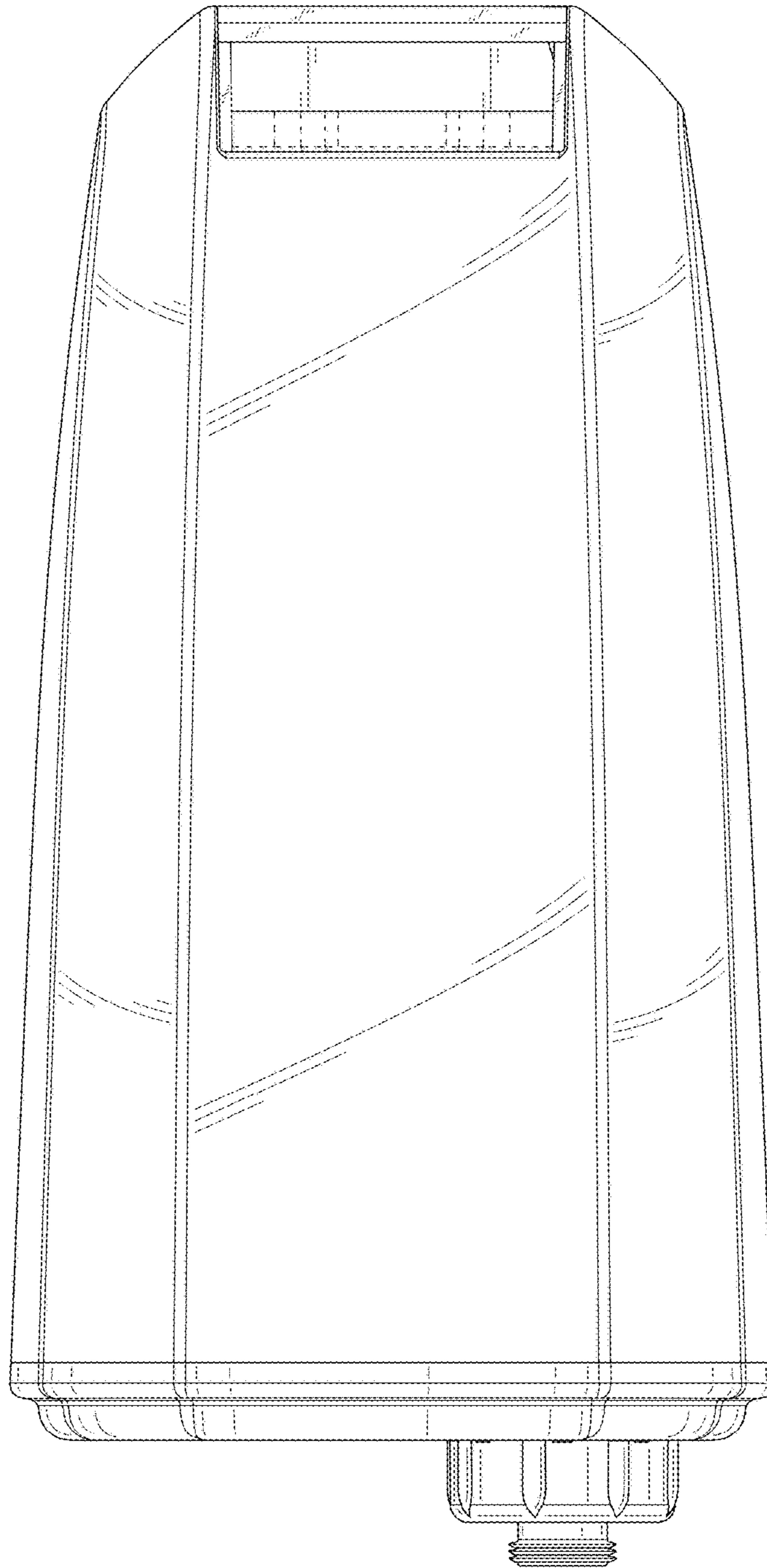

FIG. 9

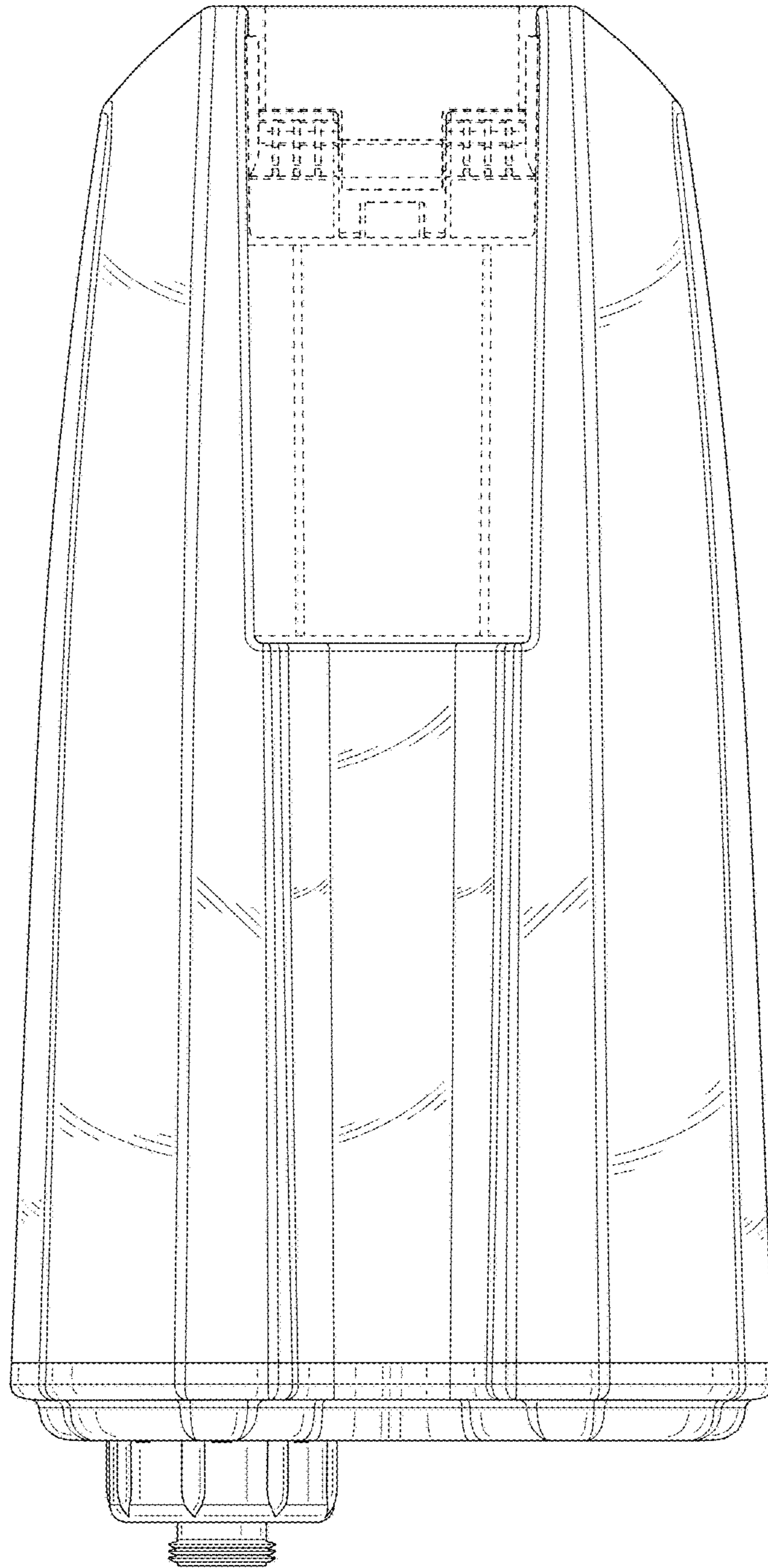

FIG. 10

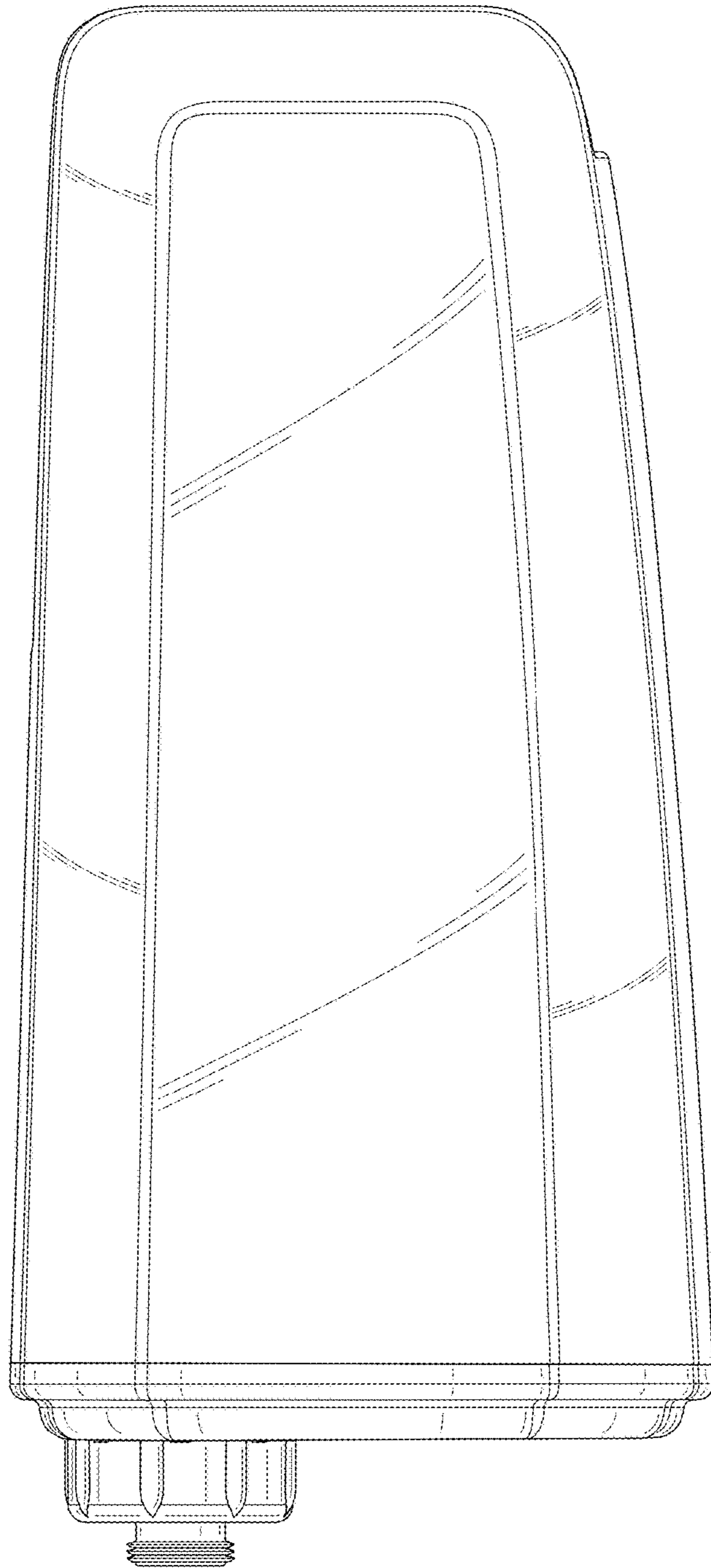

FIG. 11

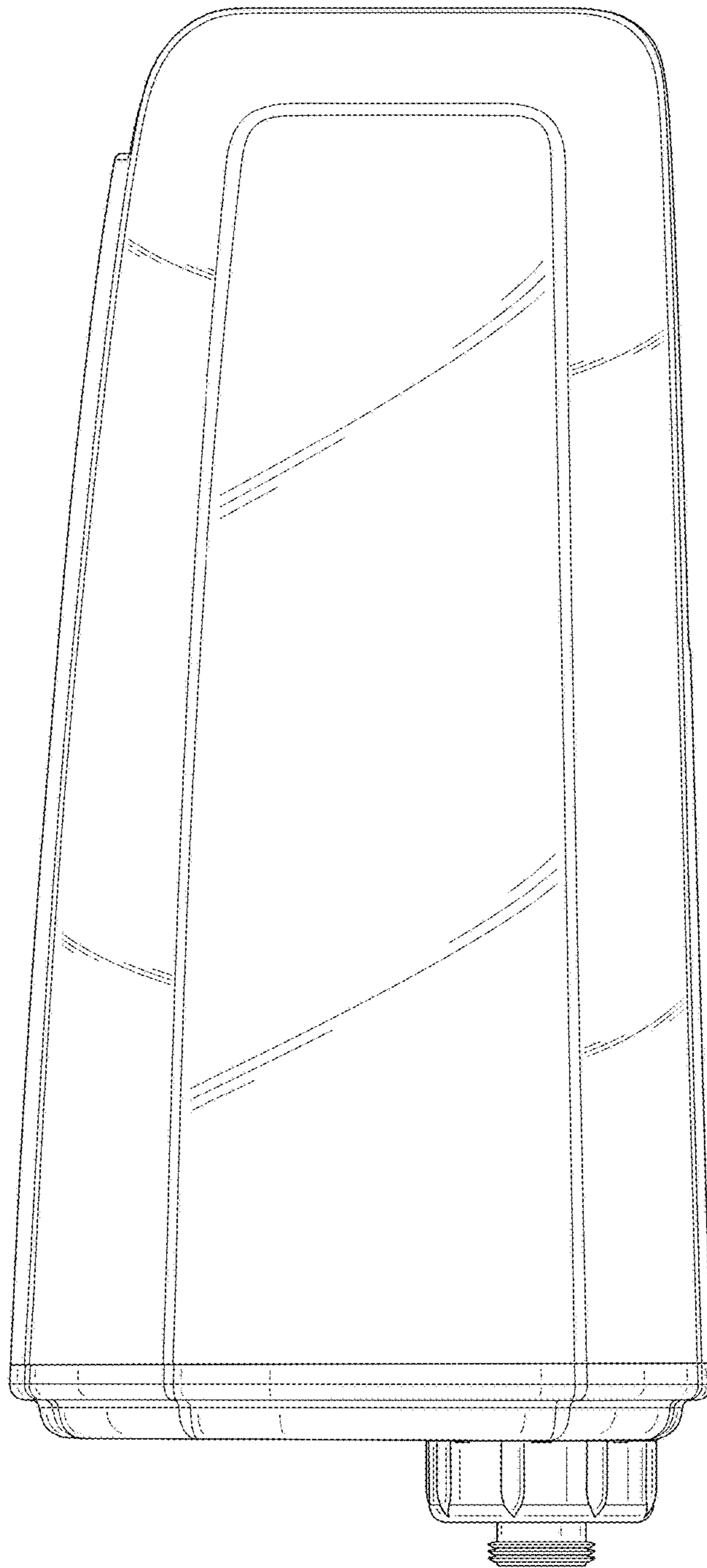

FIG. 12

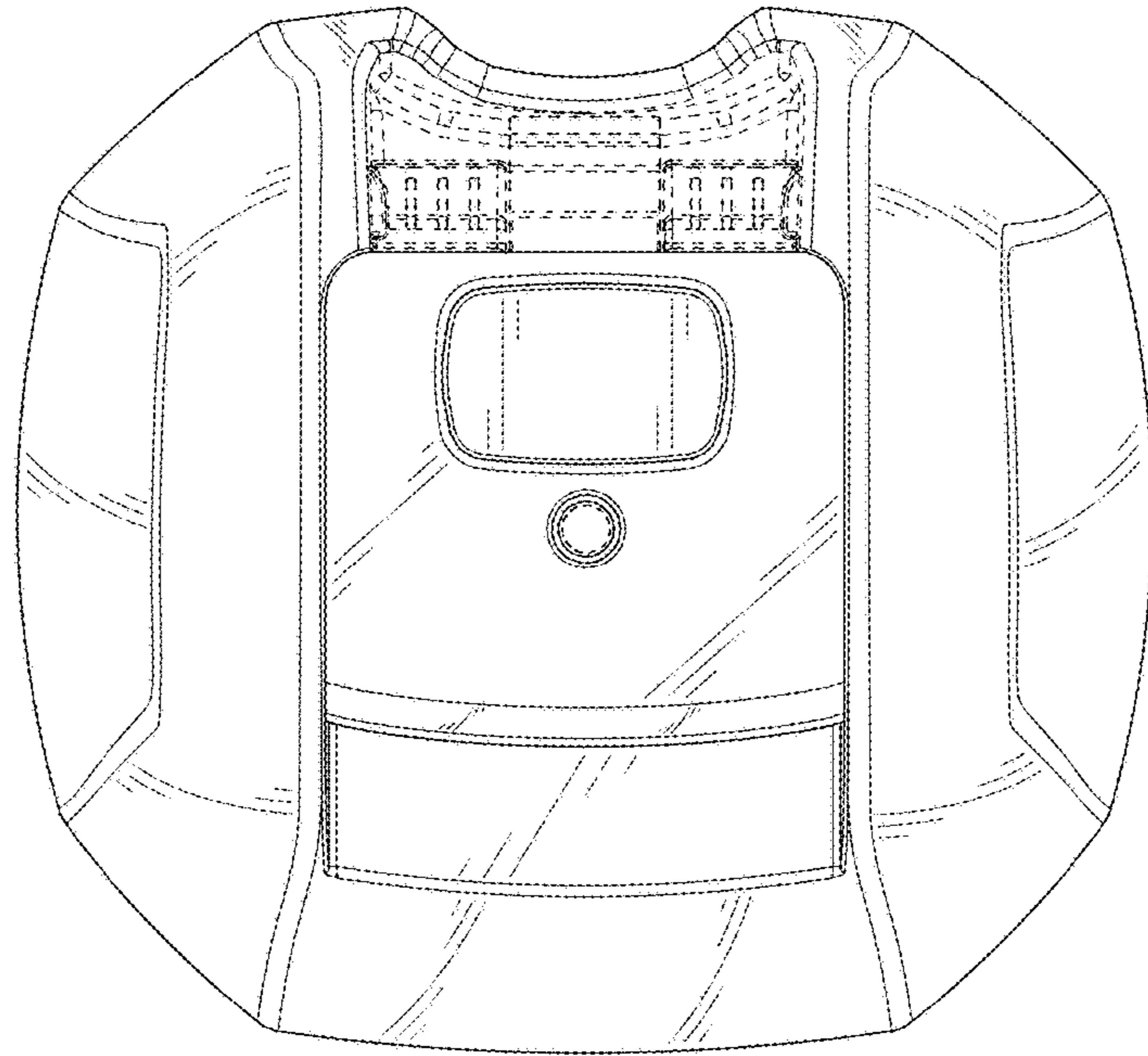

FIG. 13

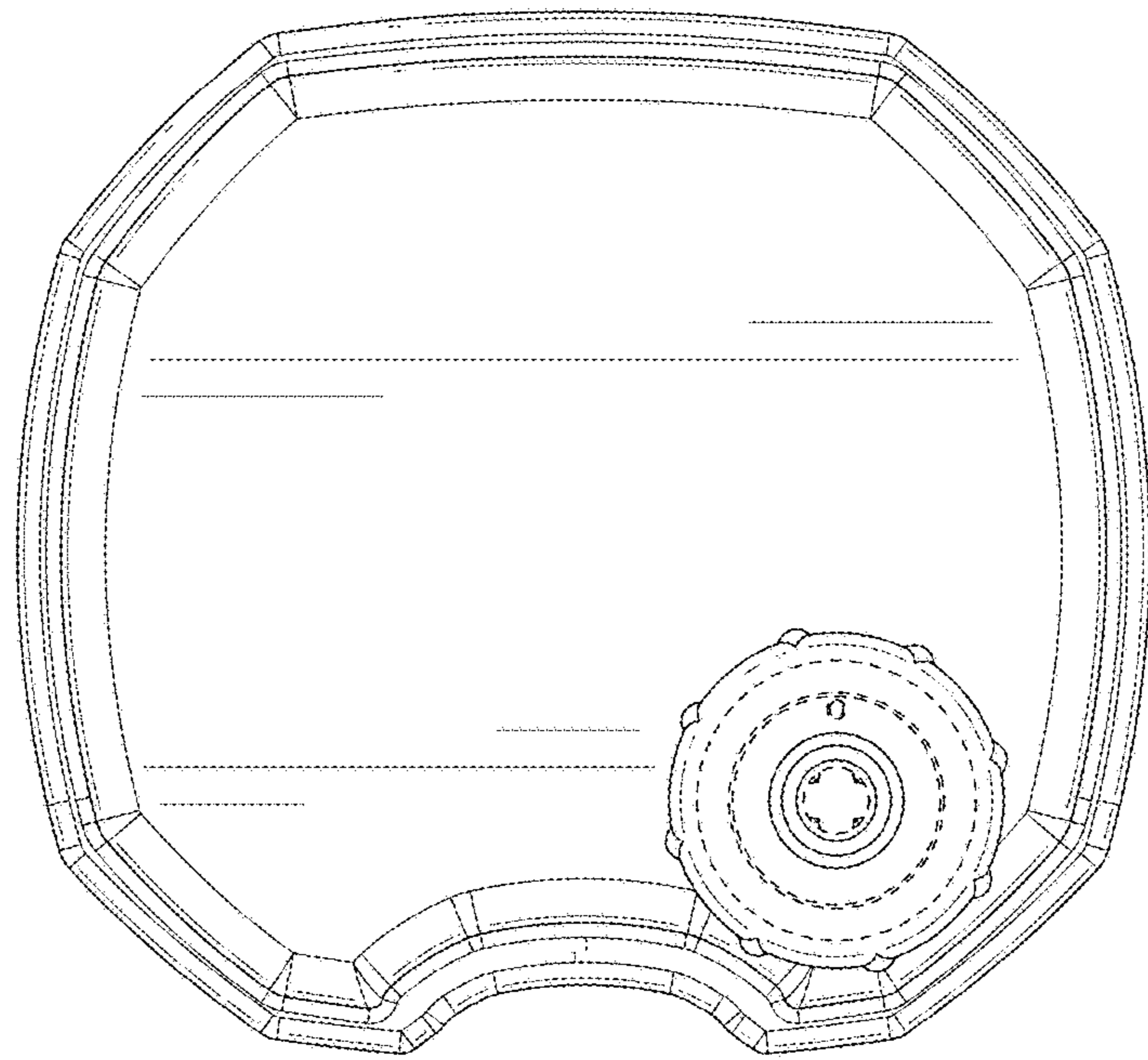

FIG. 14