



US00D857313S

(12) **United States Design Patent** (10) **Patent No.:** **US D857,313 S**
Smith et al. (45) **Date of Patent:** **** Aug. 20, 2019**

(54) **HANDHELD GARMENT STEAMERS**

(71) Applicant: **KONINKLIJKE PHILIPS N.V.**,
Eindhoven (NL)

(72) Inventors: **Peter Jonathan Smith**, Amsterdam
(NL); **Mingshuo Zhang**, Amstelveen
(NL)

(73) Assignee: **KONINKLIJKE PHILIPS N.V.**,
Eindhoven (NL)

(**) Term: **15 Years**

(21) Appl. No.: **35/504,581**

(22) Filed: **Sep. 11, 2017**

(80) **Hague Agreement Data**

Int. Filing Date: **Sep. 11, 2017**
 Int. Reg. No.: **DM/097908**
 Int. Reg. Date: **Sep. 11, 2017**
 Int. Reg. Pub. Date: **Mar. 16, 2018**

(30) **Foreign Application Priority Data**

Apr. 11, 2017 (EM) 003851062-0001
 Apr. 11, 2017 (EM) 003851062-0002
 Apr. 11, 2017 (EM) 003851062-0003
 Apr. 11, 2017 (EM) 003851062-0004

(51) **LOC (12) Cl.** **15-05**

(52) **U.S. Cl.**
USPC **D32/17**

(58) **Field of Classification Search**
 USPC D32/17, 18, 21-24, 31, 34
 CPC A47L 13/12; A47L 11/4036; A47L 9/062;
 A47L 9/0673; A47L 11/4011; A47L
 11/4061; A47L 13/225; A47L 13/256;
 A47L 15/4257; A47L 2201/04; A47L
 9/0693

See application file for complete search history.

(56) **References Cited**

U.S. PATENT DOCUMENTS

D592,365 S *	5/2009	Massip	D32/17
D622,457 S *	8/2010	Choi	D32/17
D651,774 S *	1/2012	Tobias	D32/17
D670,876 S *	11/2012	Vrdoljak	D32/17
D674,564 S *	1/2013	Mangano	D32/17
D776,887 S *	1/2017	Deffrennes	D32/17
D826,492 S *	8/2018	Huang	D32/17

* cited by examiner

Primary Examiner — Khawaja Anwar

(57) **CLAIM**

The ornamental design for a handheld garment steamer, as shown and described.

DESCRIPTION

1.-2. Handheld garment steamer
1.1 is a front perspective view of a first embodiment of a handheld garment steamer showing our design;
1.2 is a front elevational view thereof;
1.3 is a rear elevational view thereof;
1.4 is a right side elevational view thereof;
1.5 is a left side elevational view thereof;
1.6 is a top plan view thereof; and
1.7 is a bottom plan view thereof;
2.1 is a front perspective view of a second embodiment of a handheld garment steamer showing our design;
2.2 is a front elevational view thereof;
2.3 is a rear elevational view thereof;
2.4 is a right side elevational view thereof;
2.5 is a left side elevational view thereof;
2.6 is a top plan view thereof; and
2.7 is a bottom plan view thereof.

1 Claim, 14 Drawing Sheets

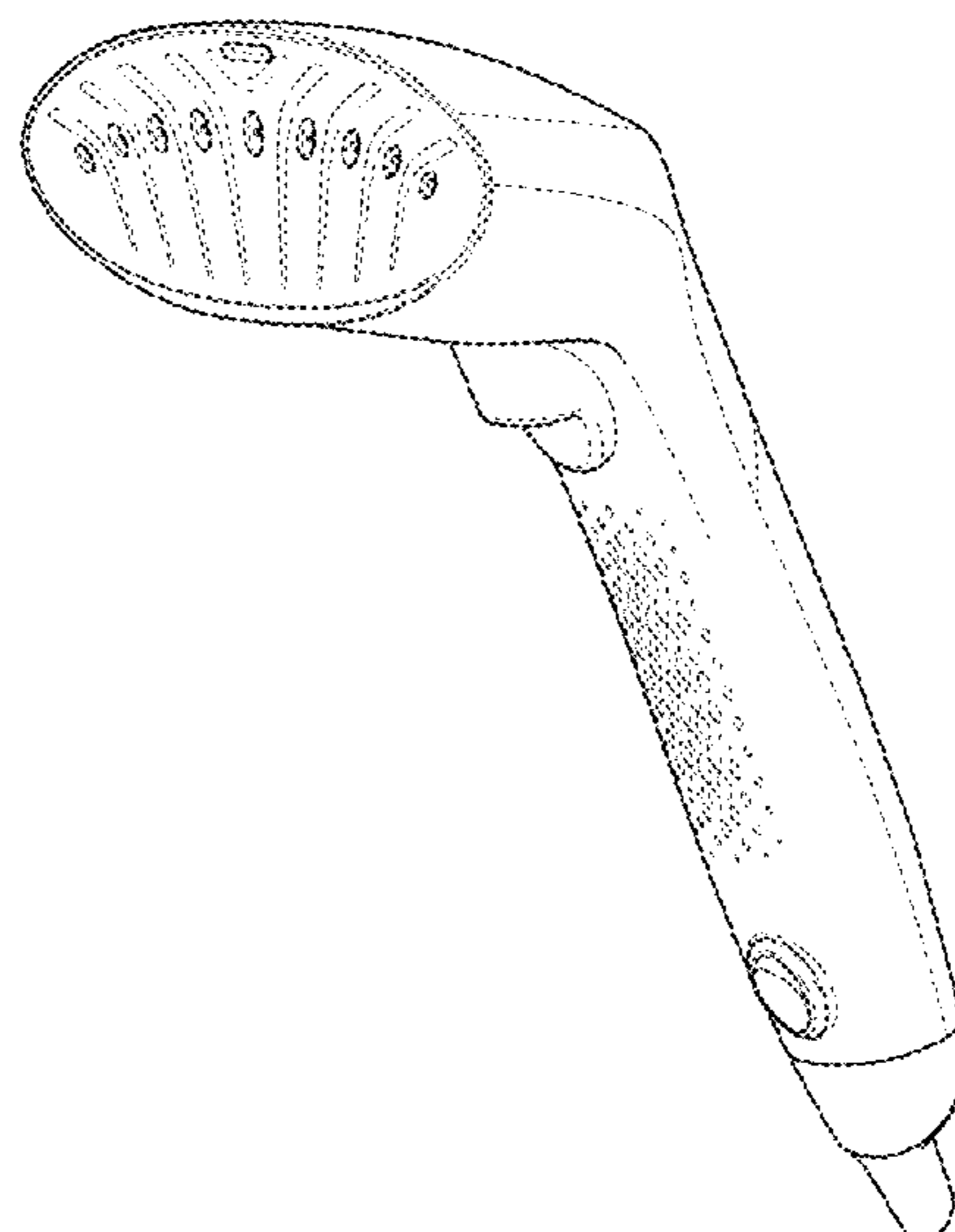
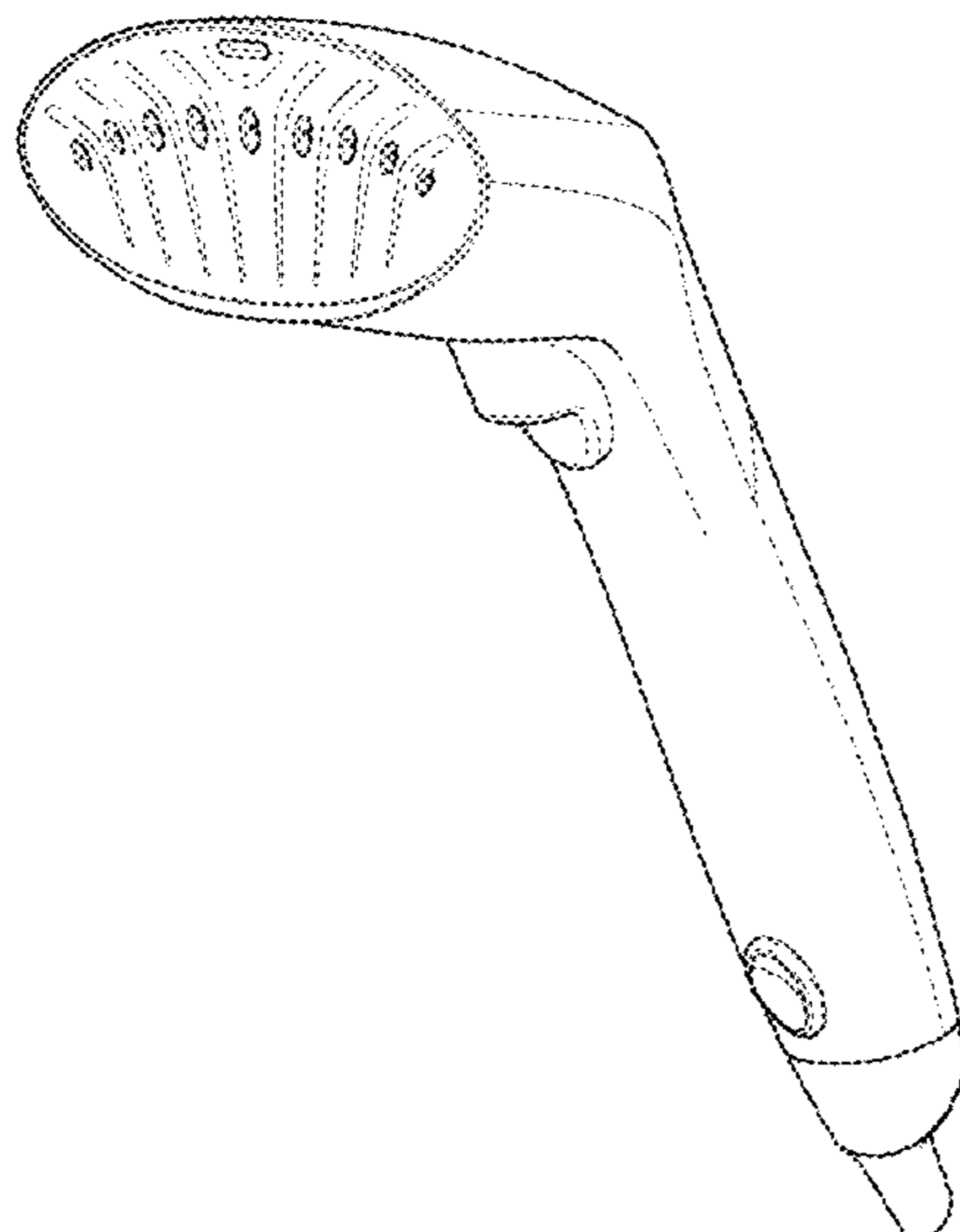

1.1

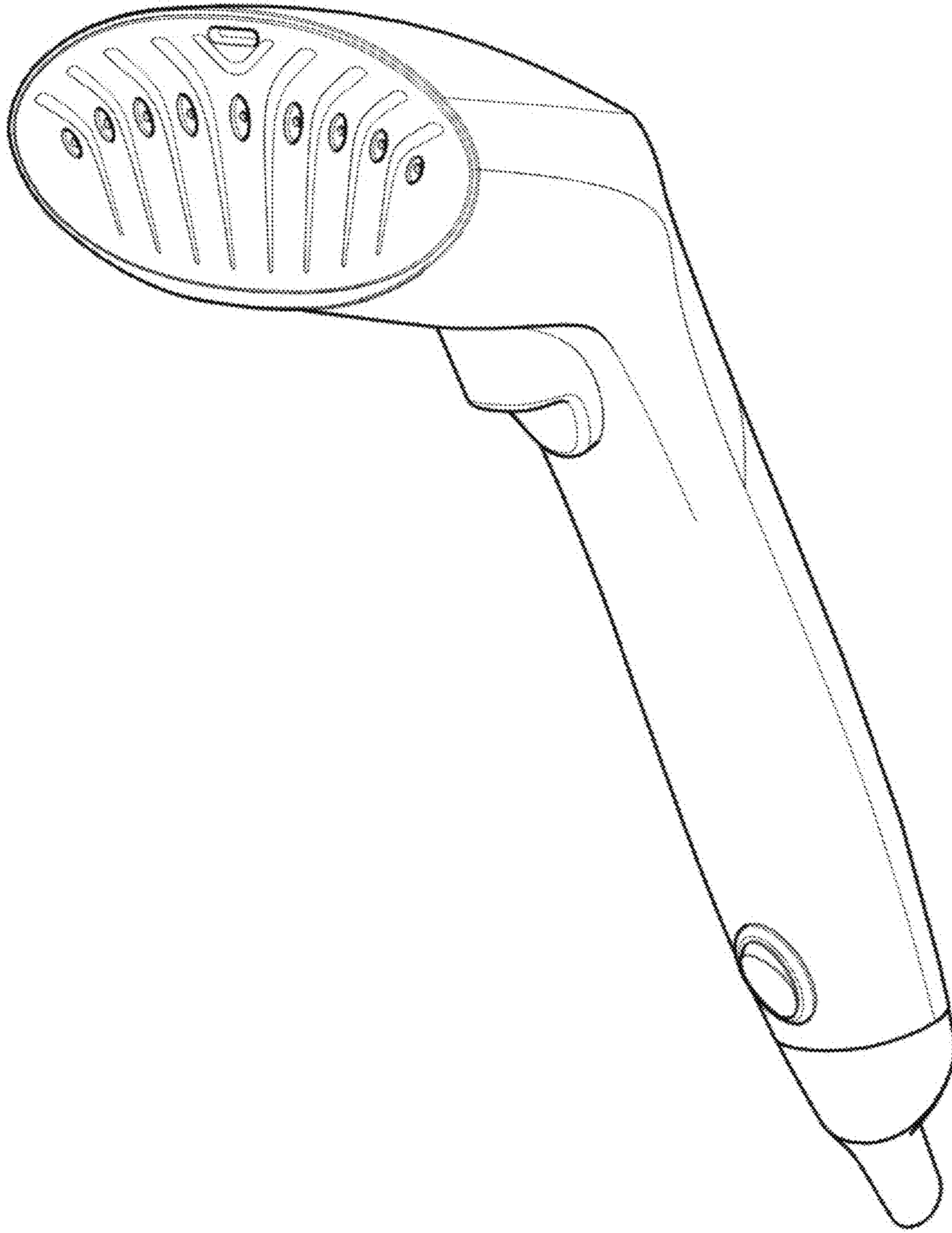

1.2

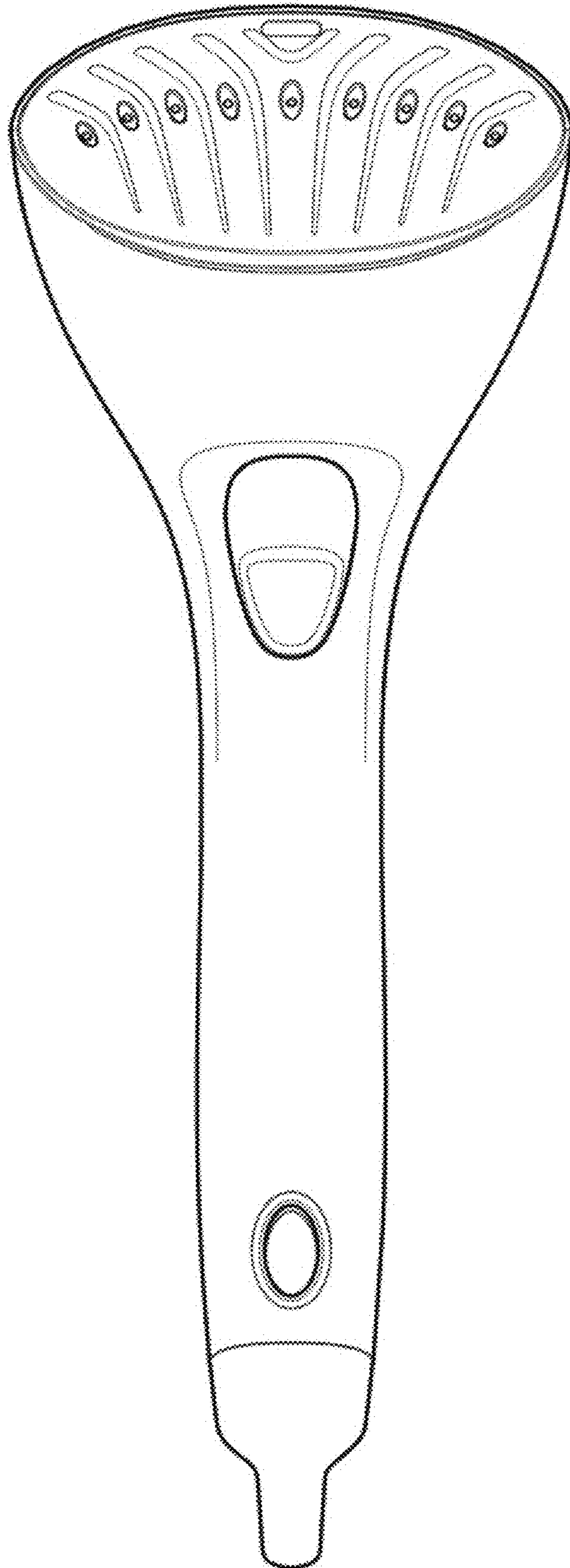

1.3

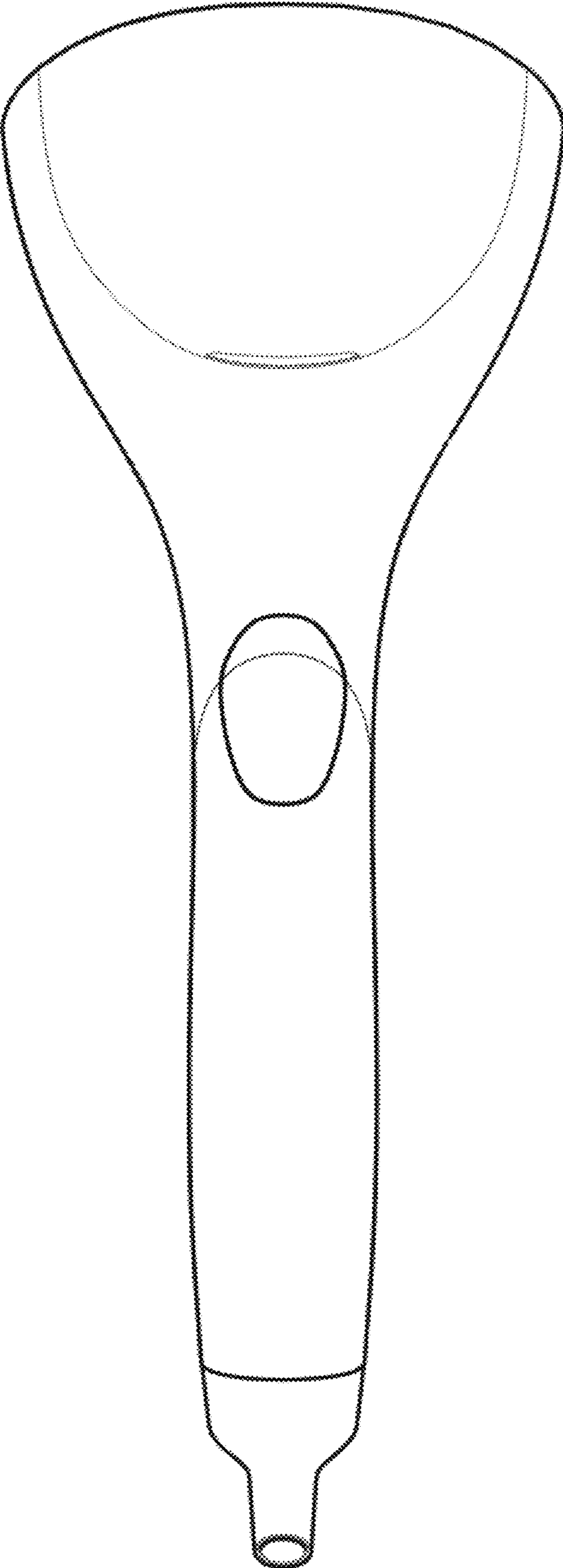

1.4

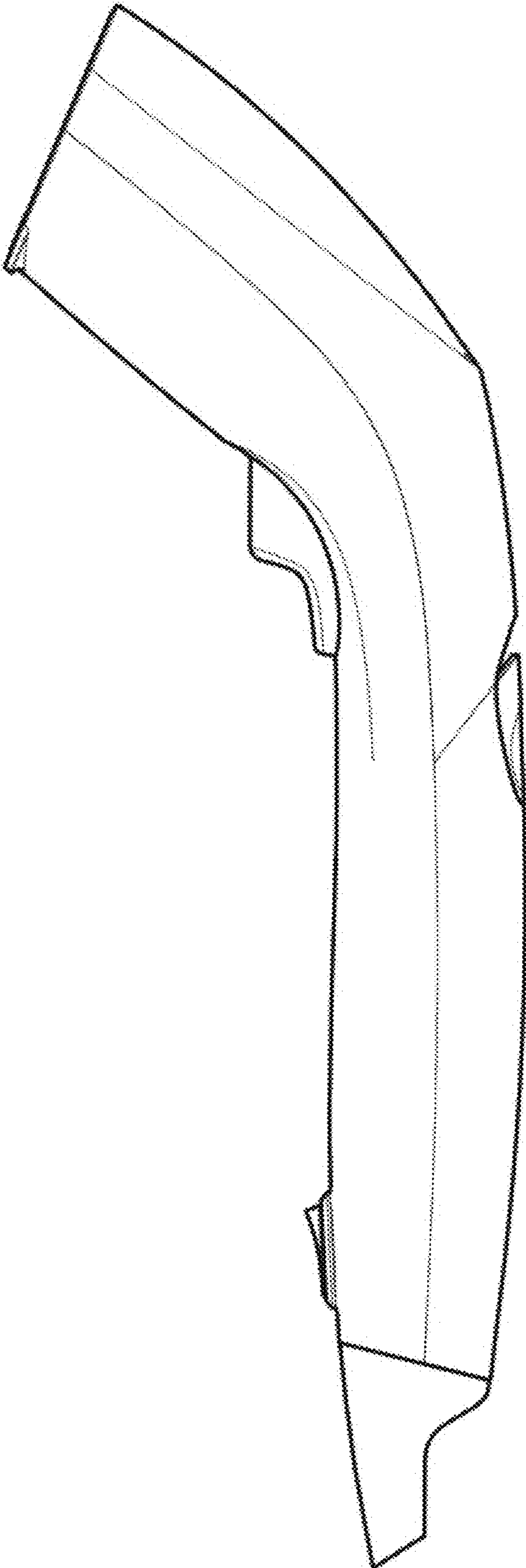

1.5

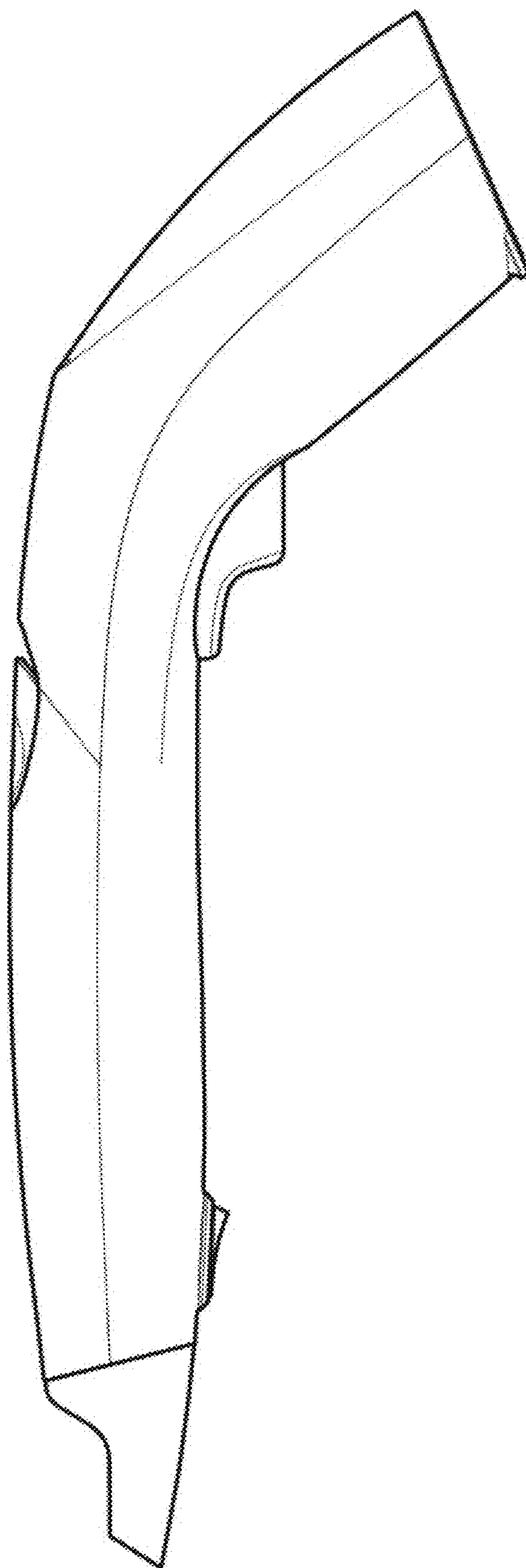

1.6

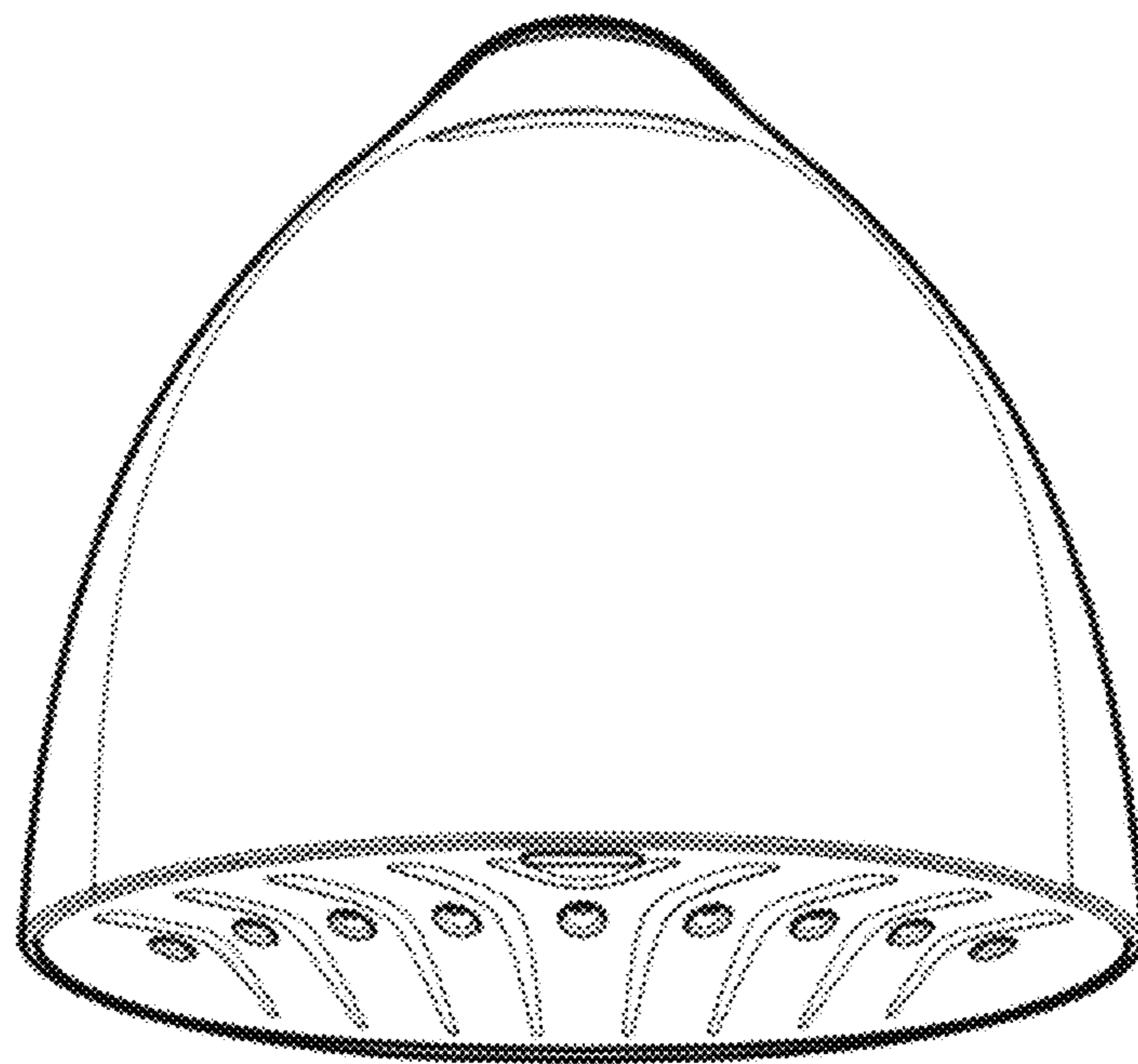

1.7

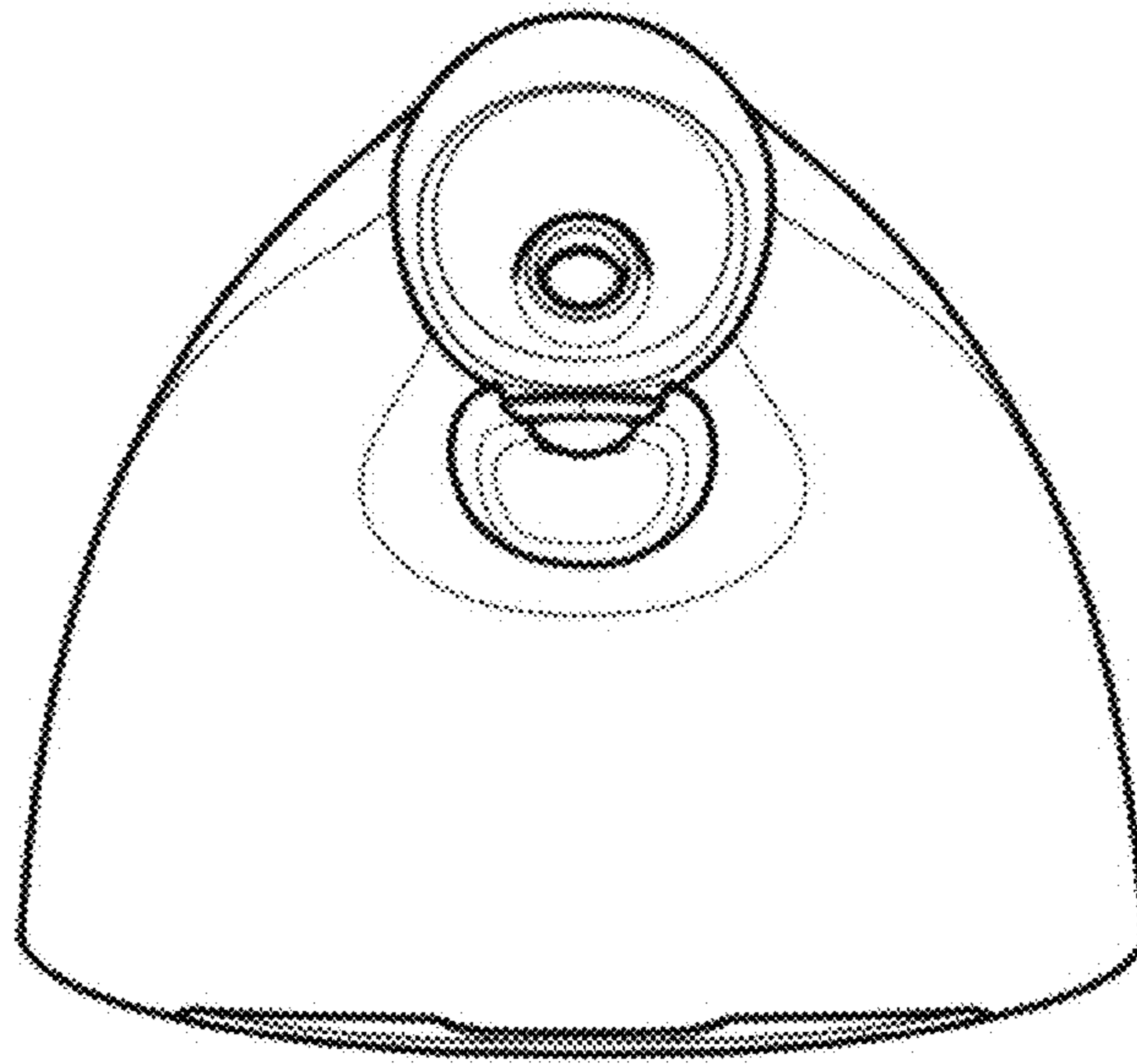

2.1

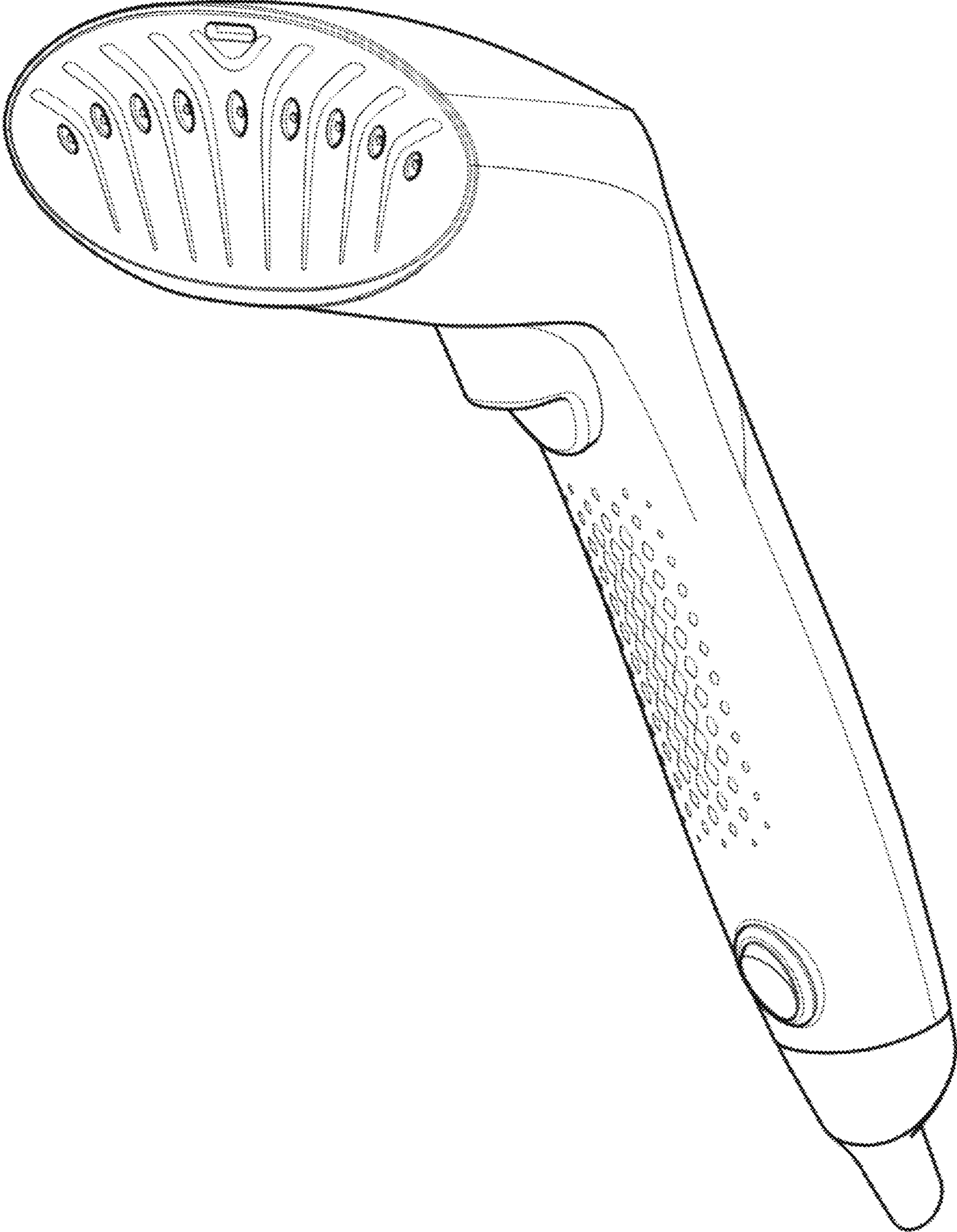

2.2

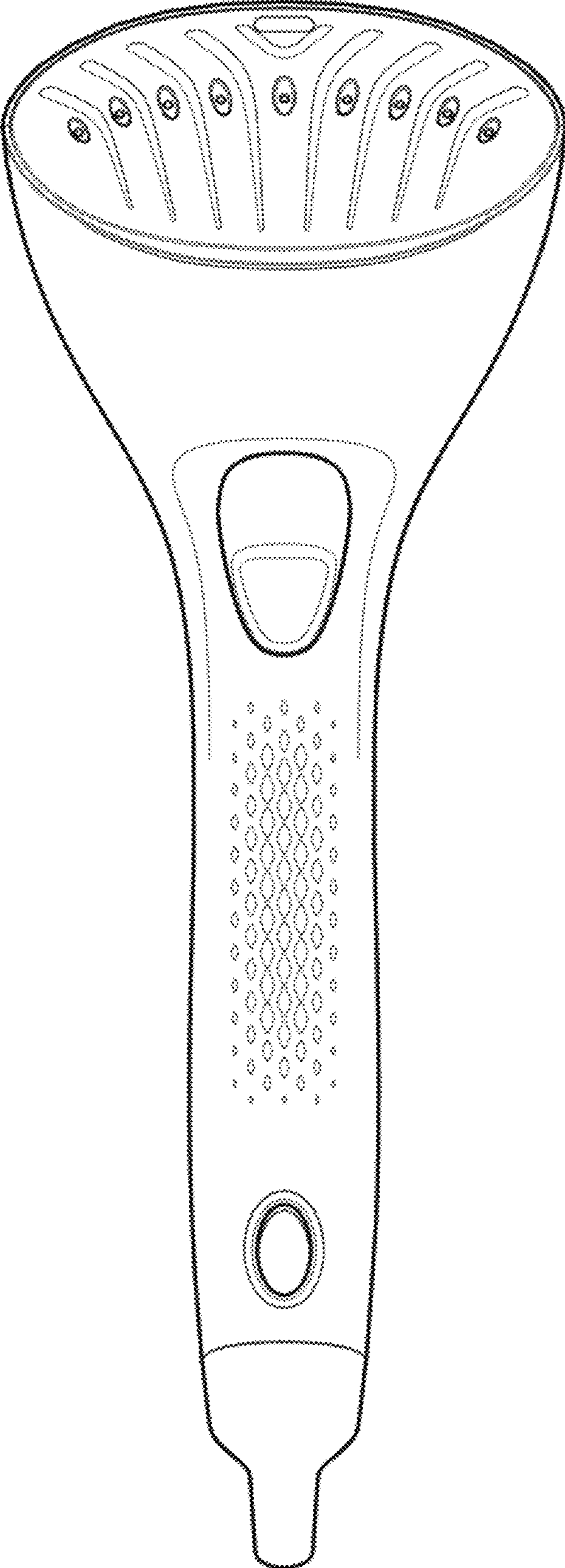

2.3

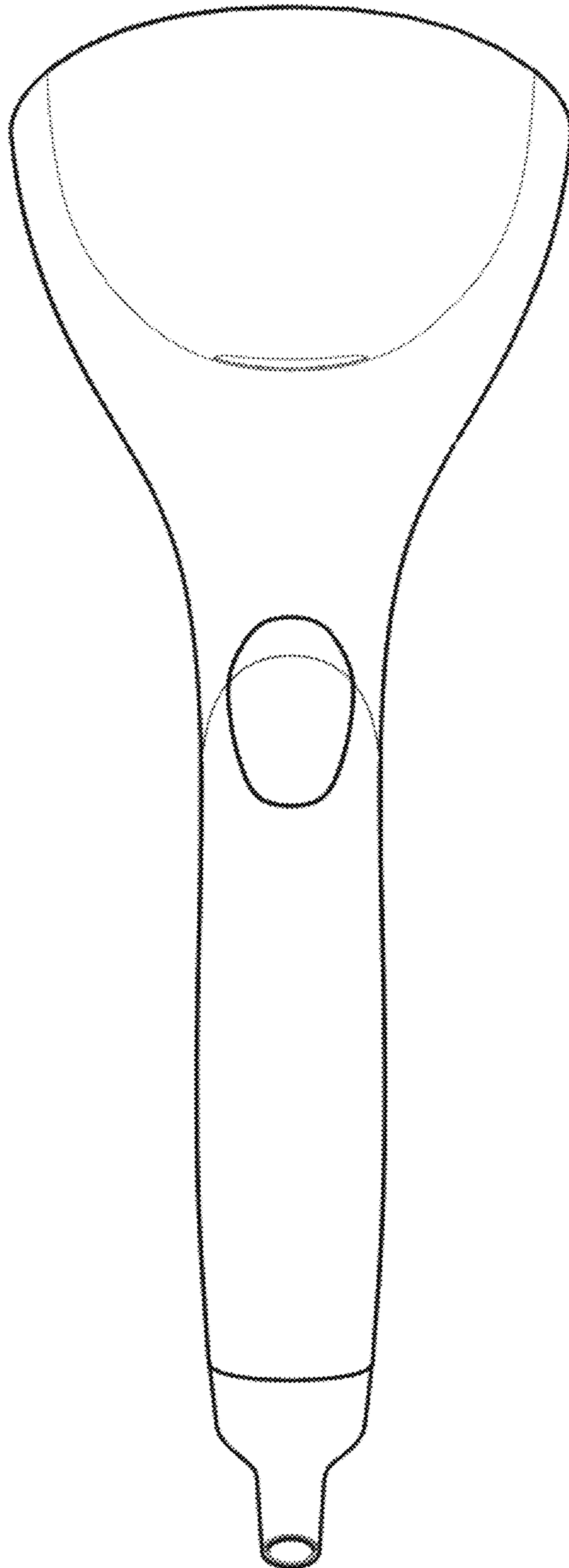

2.4

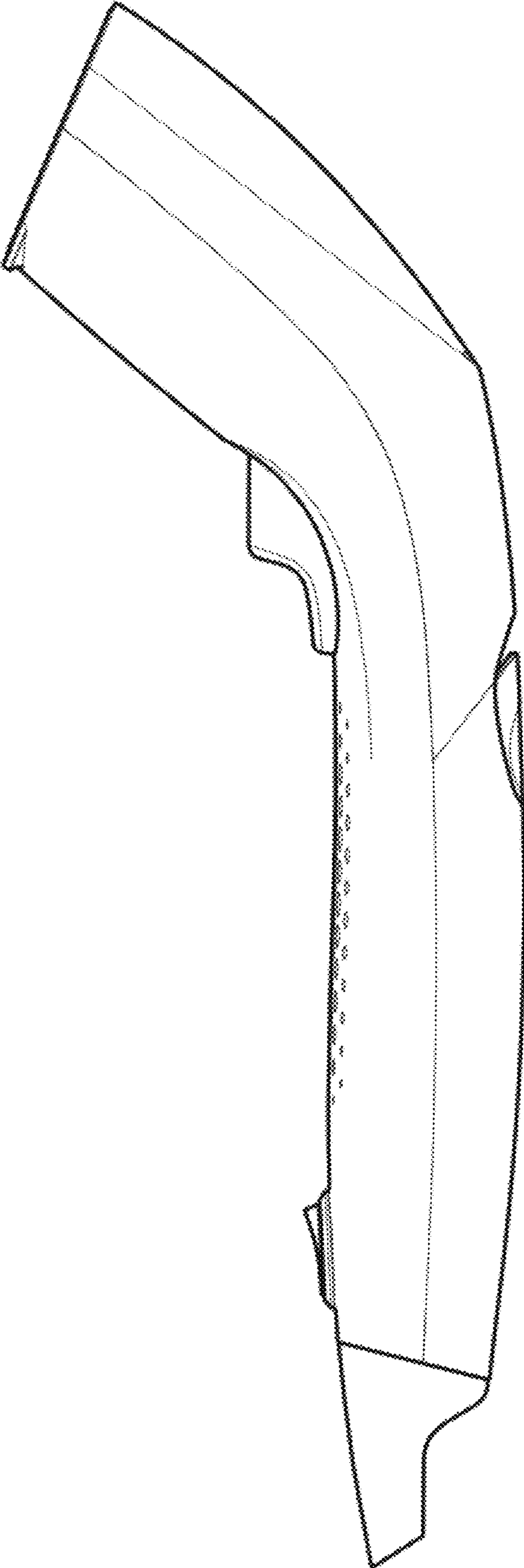

2.5

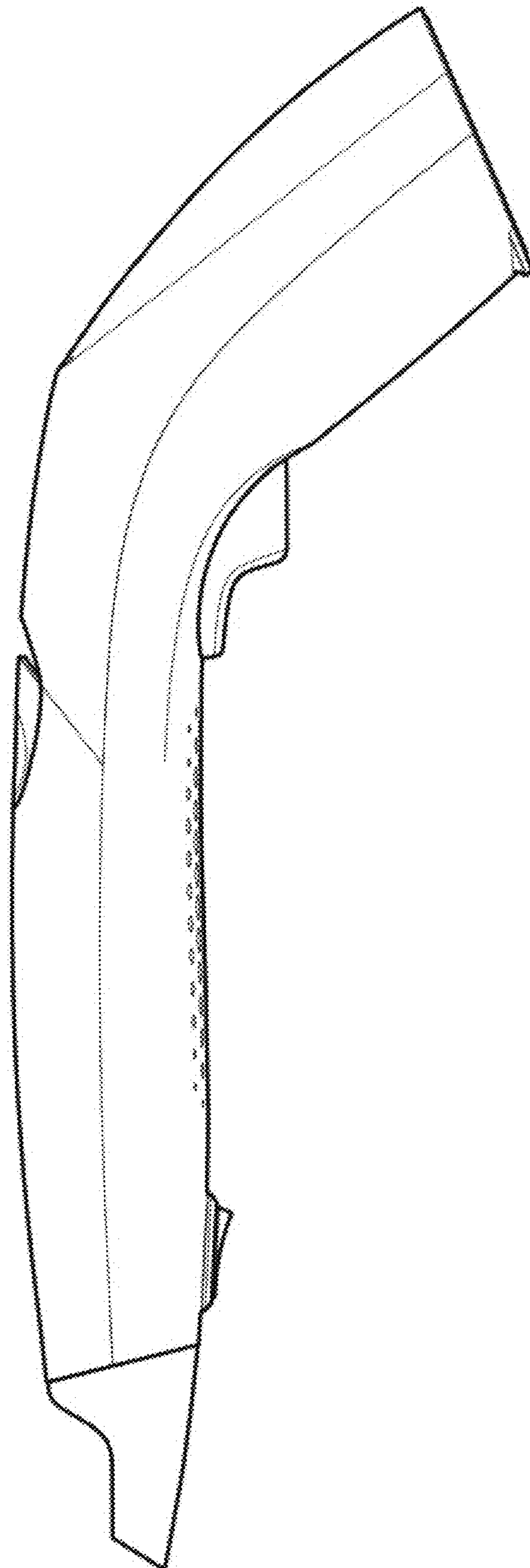

2.6

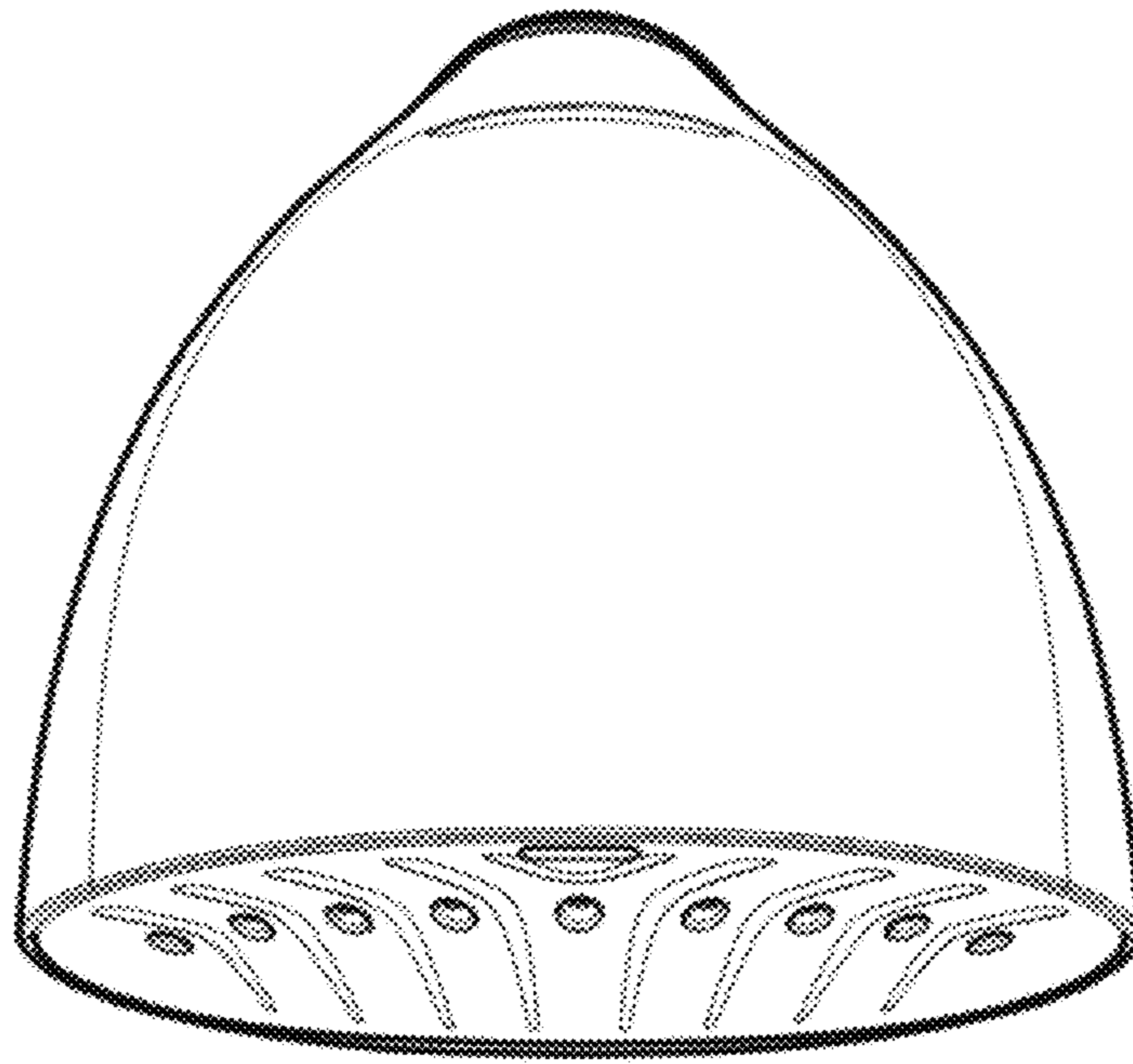

2.7

