



US00D857266S

(12) **United States Design Patent** (10) **Patent No.:** **US D857,266 S**
Choo et al. (45) **Date of Patent:** **** Aug. 20, 2019**

(54) **REAR COMBINATION LAMP FOR AN AUTOMOBILE**
(71) Applicants: **HYUNDAI MOTOR COMPANY**, Seoul (KR); **KIA MOTORS CORPORATION**, Seoul (KR)
(72) Inventors: **Dong Hoon Choo**, Suwon-si (KR); **Dai Sung Kim**, Gunpo-si (KR)
(**) Term: **15 Years**
(21) Appl. No.: **35/505,205**
(22) Filed: **Dec. 28, 2017**
(80) **Hague Agreement Data**
Int. Filing Date: **Dec. 28, 2017**
Int. Reg. No.: **DM/099650**
Int. Reg. Date: **Dec. 28, 2017**
Int. Reg. Pub. Date: **Jun. 29, 2018**

(30) **Foreign Application Priority Data**
Jun. 30, 2017 (KR) 30-2017-0030238
(51) **LOC (12) Cl.** **26-07**
(52) **U.S. Cl.**
USPC **D26/28**
CPC **F21S 43/00** (2018.01)
(58) **Field of Classification Search**
USPC D26/28-36; 362/459-468, 475-478, 362/485-487
CPC .. F21S 41/00; F21S 43/00; F21S 43/20; F21S 43/26
See application file for complete search history.

(56) **References Cited**
U.S. PATENT DOCUMENTS
D412,214 S * 7/1999 Hejtmanek D26/28
D679,432 S * 4/2013 Frenzel D26/28

D714,978 S * 10/2014 Lee D26/28
D716,478 S * 10/2014 Loeb D26/28
D720,484 S * 12/2014 Nordmann D26/28
D739,583 S * 9/2015 Forsgren D26/28
D749,247 S * 2/2016 Han D26/28
D749,248 S * 2/2016 Gorsten Schuenemann .. D26/28
D749,759 S * 2/2016 Beaven D26/28
D755,420 S * 5/2016 Ko D26/28
D761,979 S * 7/2016 Wu D26/28
D761,982 S * 7/2016 Akita D26/28
D764,082 S * 8/2016 Frascella D26/28
D767,803 S * 9/2016 Faghihzadeh D26/28
D769,485 S * 10/2016 Morikawa D26/28
D776,312 S * 1/2017 Han D26/28
D776,313 S * 1/2017 Han D26/28
D794,843 S * 8/2017 Han D26/28
D794,850 S * 8/2017 Kim D26/28
D797,330 S * 9/2017 Katou D26/28
D806,919 S * 1/2018 Hatton D26/28
D806,921 S * 1/2018 Ryu D26/28
D808,048 S * 1/2018 Hannemann D26/28
D810,974 S * 2/2018 Sato D26/28
D810,977 S * 2/2018 Piscitelli D26/28
D811,633 S * 2/2018 Gould D26/28
D812,271 S * 3/2018 Katagiri D26/28
D812,273 S * 3/2018 Wu D26/28
D812,792 S * 3/2018 Jae D26/28
D834,226 S * 11/2018 Lee D26/28

(Continued)

Primary Examiner — Richard E Chilcot

(57) **CLAIM**

The ornamental design for a rear combination lamp for an automobile, as shown and described.

DESCRIPTION

- 1. Rear combination lamp for an automobile
- 1.1 : Perspective
- 1.2 : Front
- 1.3 : Back
- 1.4 : Left
- 1.5 : Right
- 1.6 : Top
- 1.7 : Bottom

1 Claim, 7 Drawing Sheets

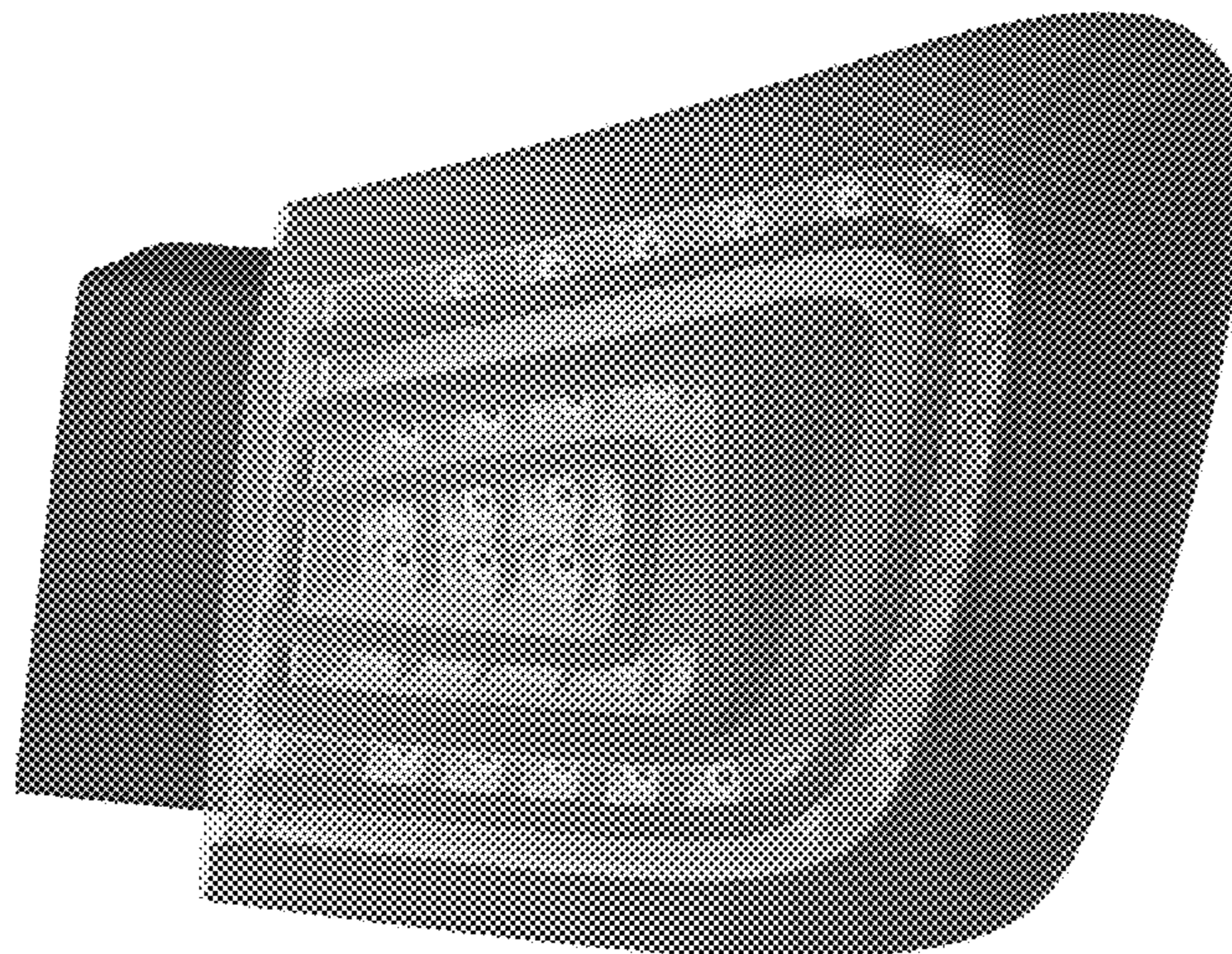

(56)

References Cited

U.S. PATENT DOCUMENTS

D834,227 S	*	11/2018	Lee	D26/28
D834,228 S	*	11/2018	Lee	D26/28
D834,229 S	*	11/2018	Lee	D26/28
D834,230 S	*	11/2018	Lee	D26/28
D841,202 S	*	2/2019	Badstuebner	D26/28

* cited by examiner

1.1

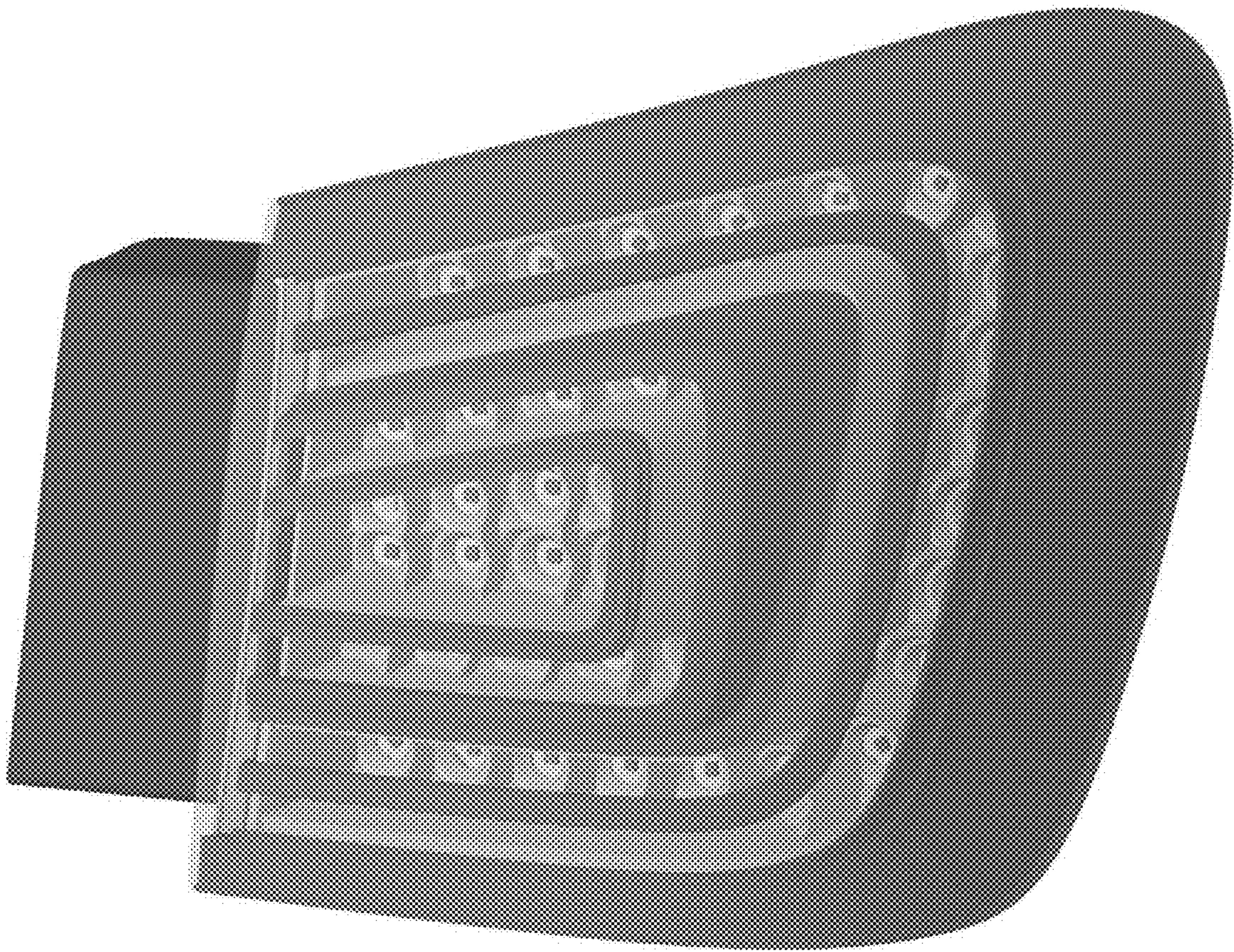

1.2

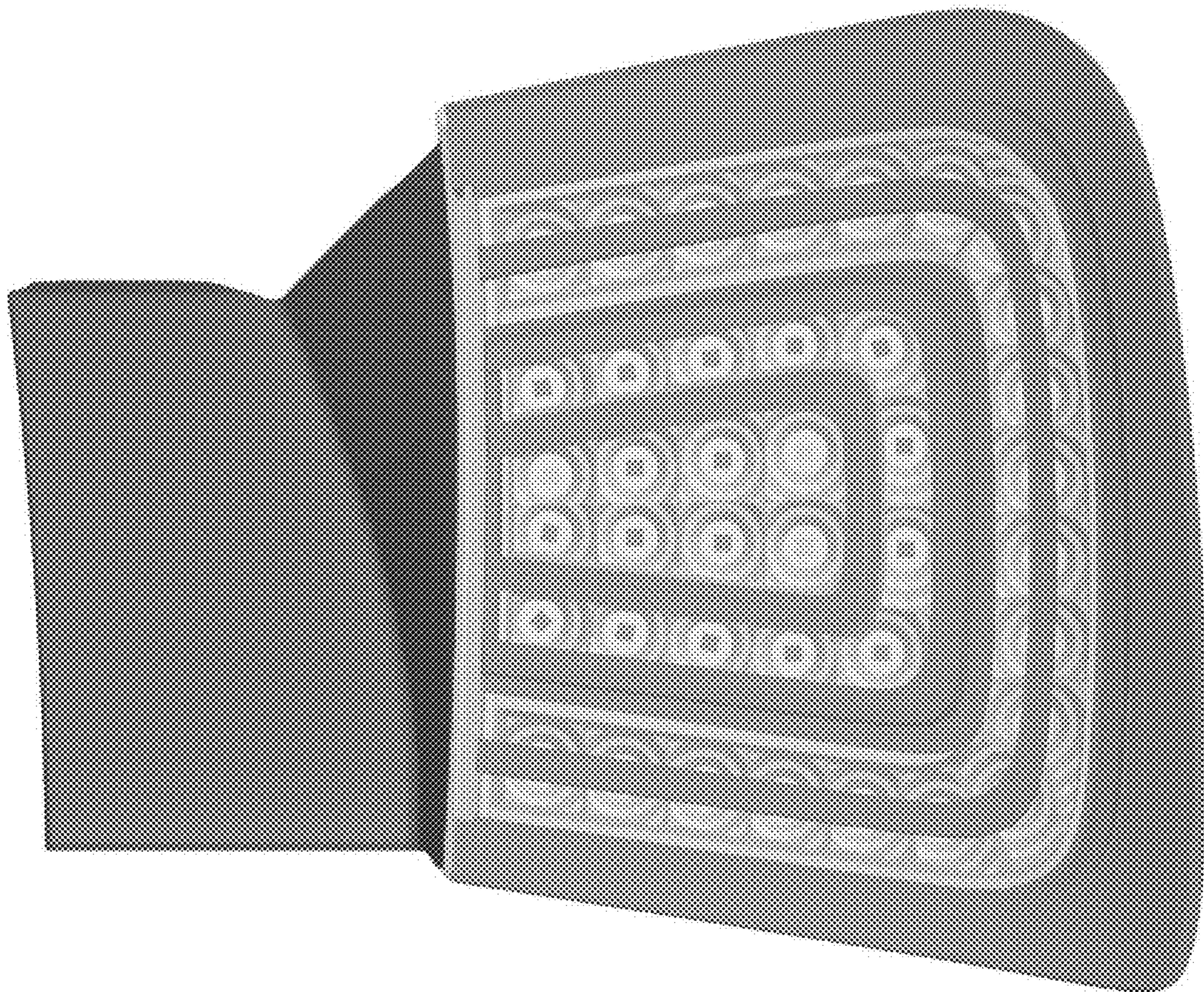

1.3

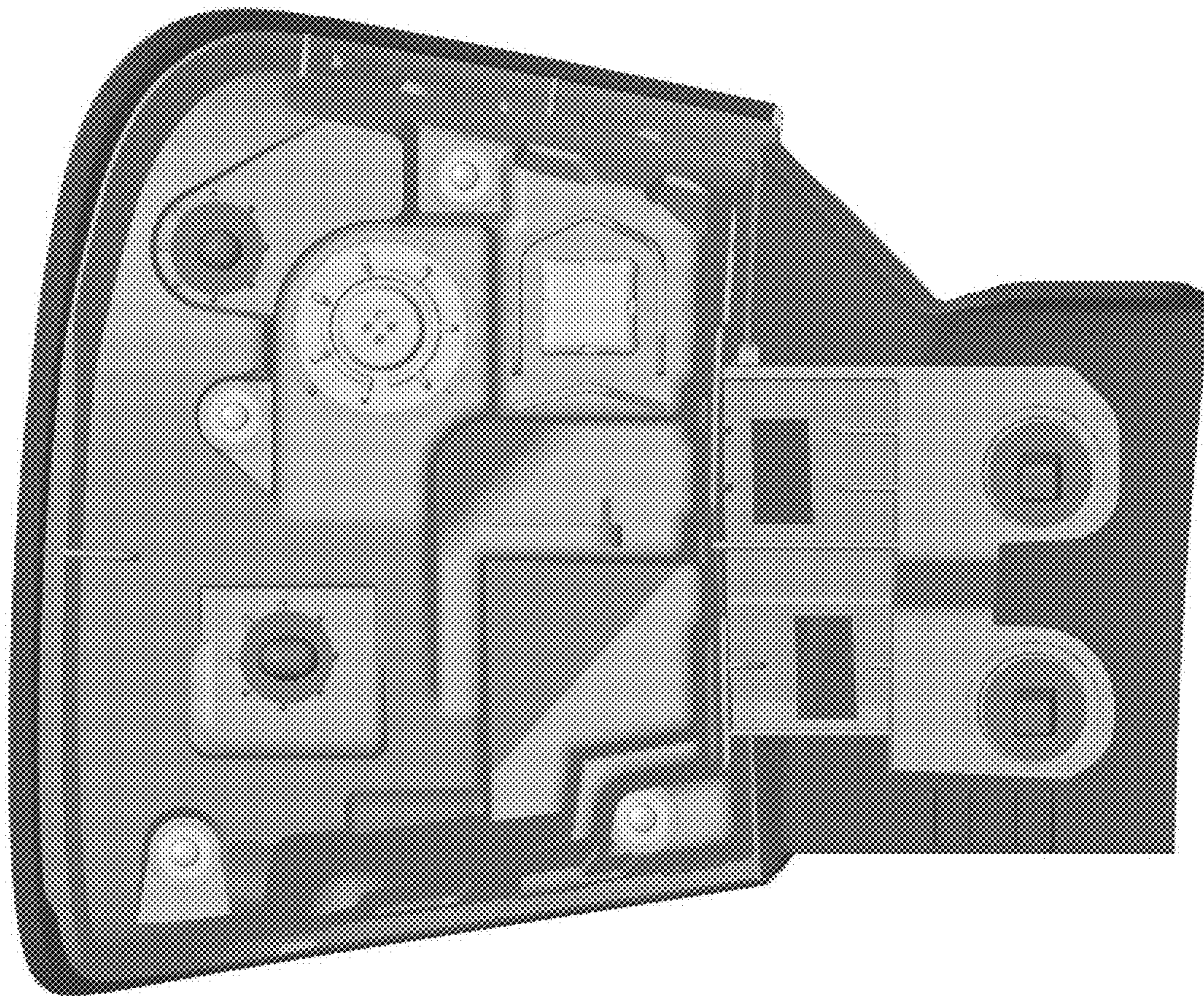

1.4

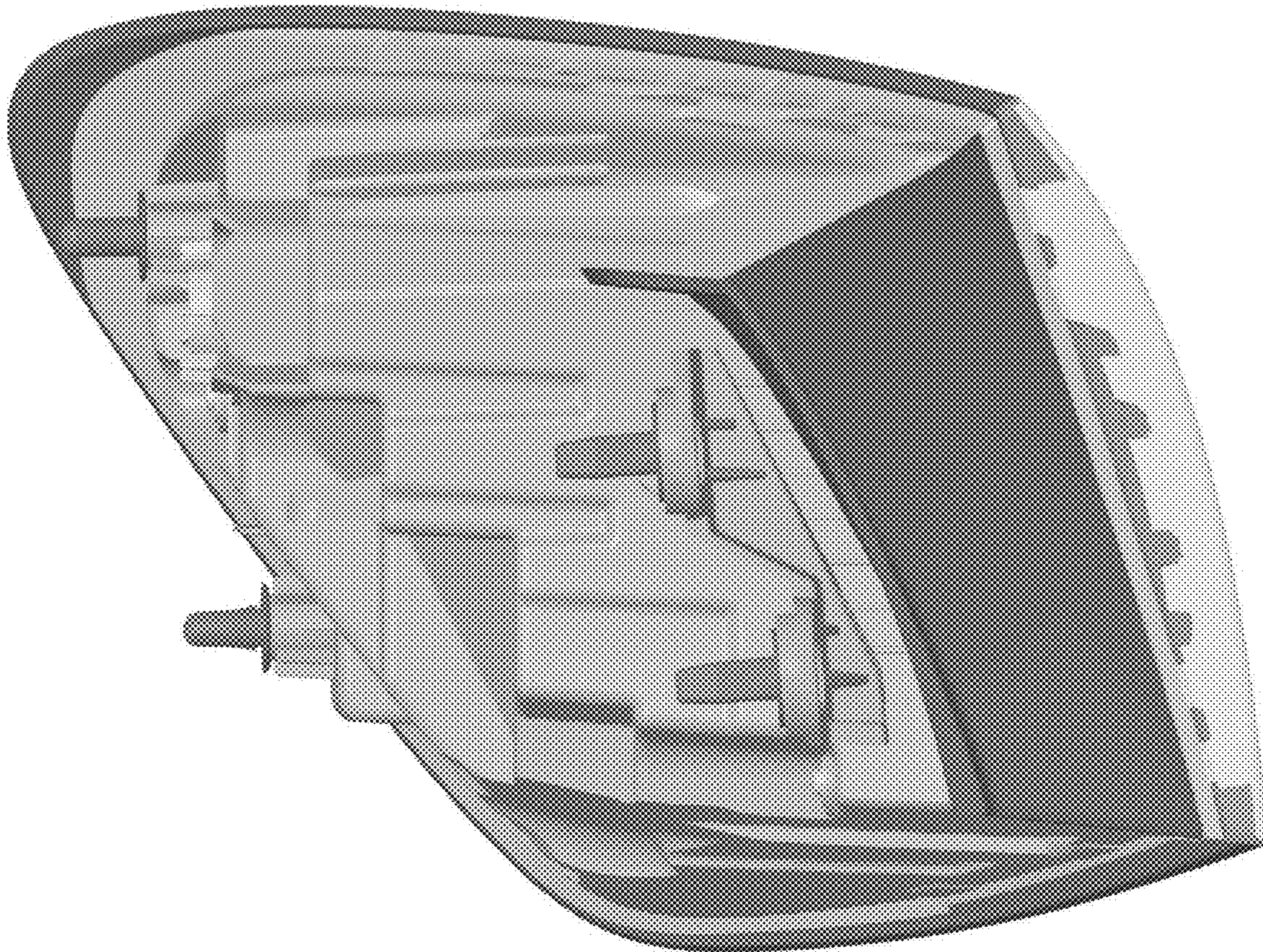

1.5

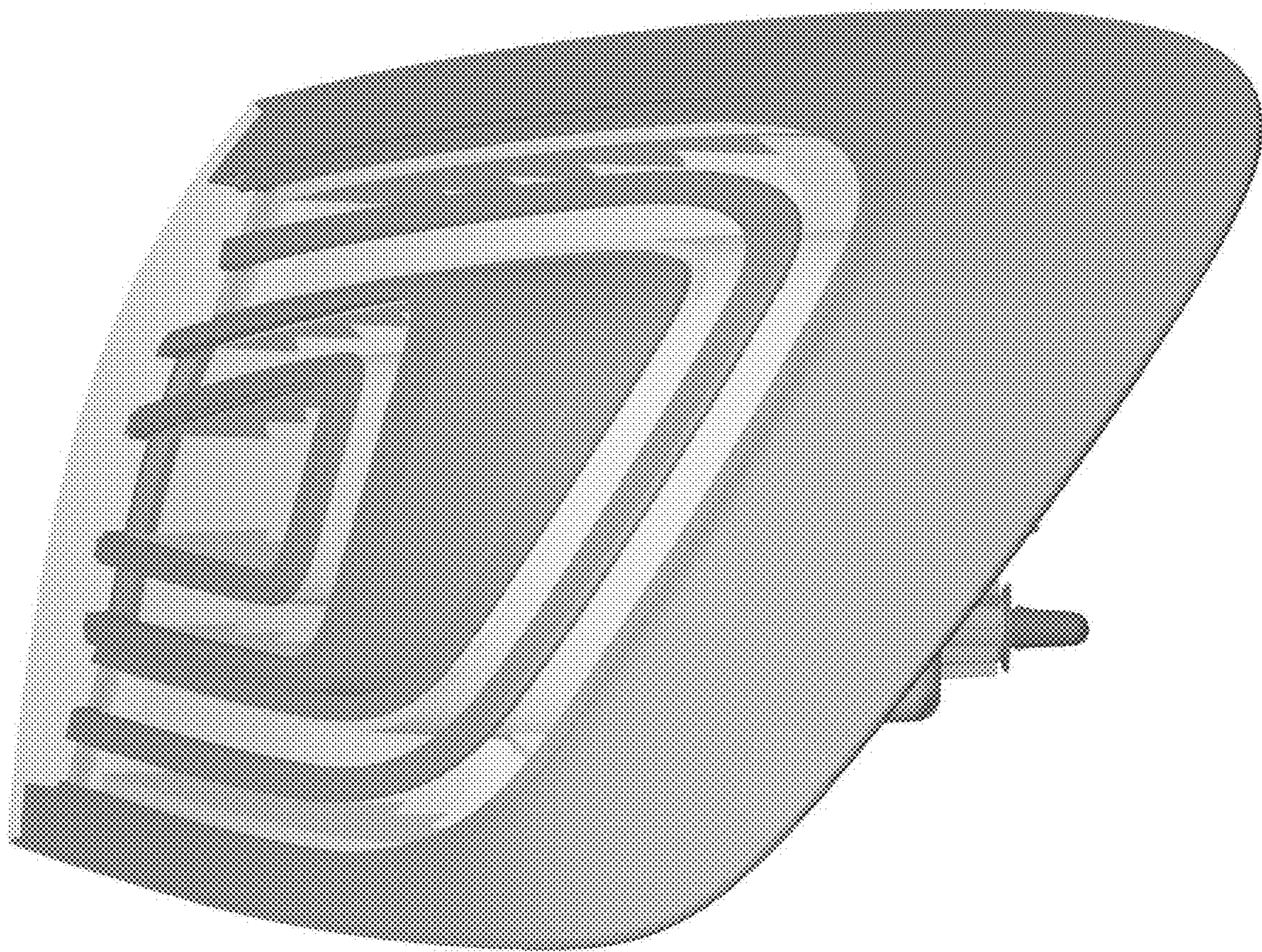

1.6

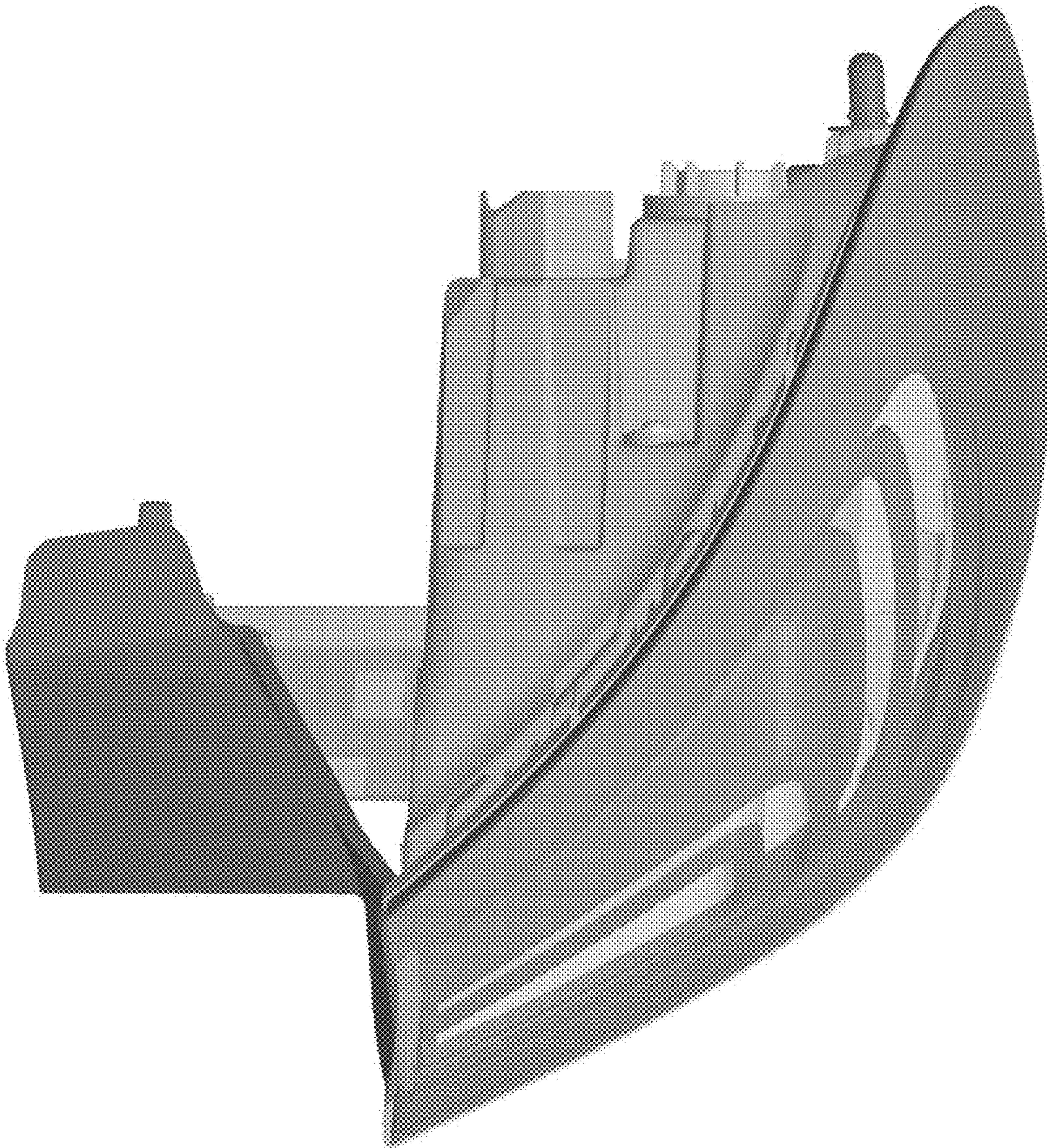

1.7

