



US00D857237S

(12) **United States Design Patent** (10) **Patent No.:** **US D857,237 S**
Bryant (45) **Date of Patent:** **** Aug. 20, 2019**

- (54) **DOOR THRESHOLD SEAL**
- (71) Applicant: **MJB Wood Group, Inc.**, Irving, TX (US)
- (72) Inventor: **David C Bryant**, Richmond, IN (US)
- (73) Assignee: **MJB Wood Group, LLC**, Wilmington, DE (US)
- (**) Term: **15 Years**
- (21) Appl. No.: **29/630,013**
- (22) Filed: **Dec. 18, 2017**
- (51) **LOC (12) Cl.** **25-02**
- (52) **U.S. Cl.**
USPC **D25/48.2**
- (58) **Field of Classification Search**
USPC D25/48.1, 48.2, 48.3, 60, 61, 119-125, D25/164, 199
CPC E06B 1/00; E06B 1/02; E06B 1/04; E06B 1/045; E06B 1/006; E06B 1/70; E06B 1/12; E06B 1/34; E06B 1/342; E06B 7/14; E06B 7/26; E04C 3/00; E04C 3/02; E04C 3/04; E04C 3/005; E04C 3/12; E04C 3/20; E04C 3/28; E04C 3/30; E04F 19/02; E04F 19/022; E04F 19/026; E04F 19/028; E04F 19/04; E04F 19/0436; E04F 19/0481; E04F 19/0486; E04F 19/06; E04F 19/061
See application file for complete search history.

D638,143	S	*	5/2011	Procton	D25/119
D733,926	S	*	7/2015	Van Camp	D25/48.2
D733,927	S	*	7/2015	Van Camp	D25/48.2
D766,458	S	*	9/2016	Chapman	D25/48.2
D814,054	S	*	3/2018	Ewoldt	D25/119
D829,927	S	*	10/2018	McClure	D25/48.2
2007/0205609	A1	*	9/2007	Meeks	E05C 1/04 292/137
2008/0229668	A1	*	9/2008	Meeks	E05C 1/02 49/367

(Continued)

OTHER PUBLICATIONS

<http://www.allaboutdoors.com/Products/Door-Thresholds-Sills> Aug. 31, 2017 (Year: 2017).*

(Continued)

Primary Examiner — Leanne Was-Englehart
(74) *Attorney, Agent, or Firm* — Davidson Law Group, ALC; Payam Moradian

(57) **CLAIM**

I claim the ornamental design for a door threshold seal, as shown and described.

DESCRIPTION

FIG. 1 is a perspective view of the door threshold seal, showing my new design;
FIG. 2 is a left side view thereof;
FIG. 3 is a right side view thereof;
FIG. 4 is a front side view thereof;
FIG. 5 is a back side view thereof;
FIG. 6 is a top view thereof; and,
FIG. 7 is a bottom view thereof.
The evenly spaced broken lines depict portions of the door threshold seal that form no part of the claimed design. The dot-dash broken lines depict a symbolic break. The portion between the break lines forms no part of the claimed design.

1 Claim, 4 Drawing Sheets

- (56) **References Cited**
U.S. PATENT DOCUMENTS
- 5,136,814 A 8/1992 Headrick
- 5,230,181 A 7/1993 Geoffrey et al.
- 5,426,894 A 6/1995 Headrick
- D380,280 S * 6/1997 Ingraham D25/119
- D435,120 S * 12/2000 Bevan D25/119
- 6,345,477 B1 2/2002 Kepler et al.
- D621,066 S * 8/2010 Selles D25/60

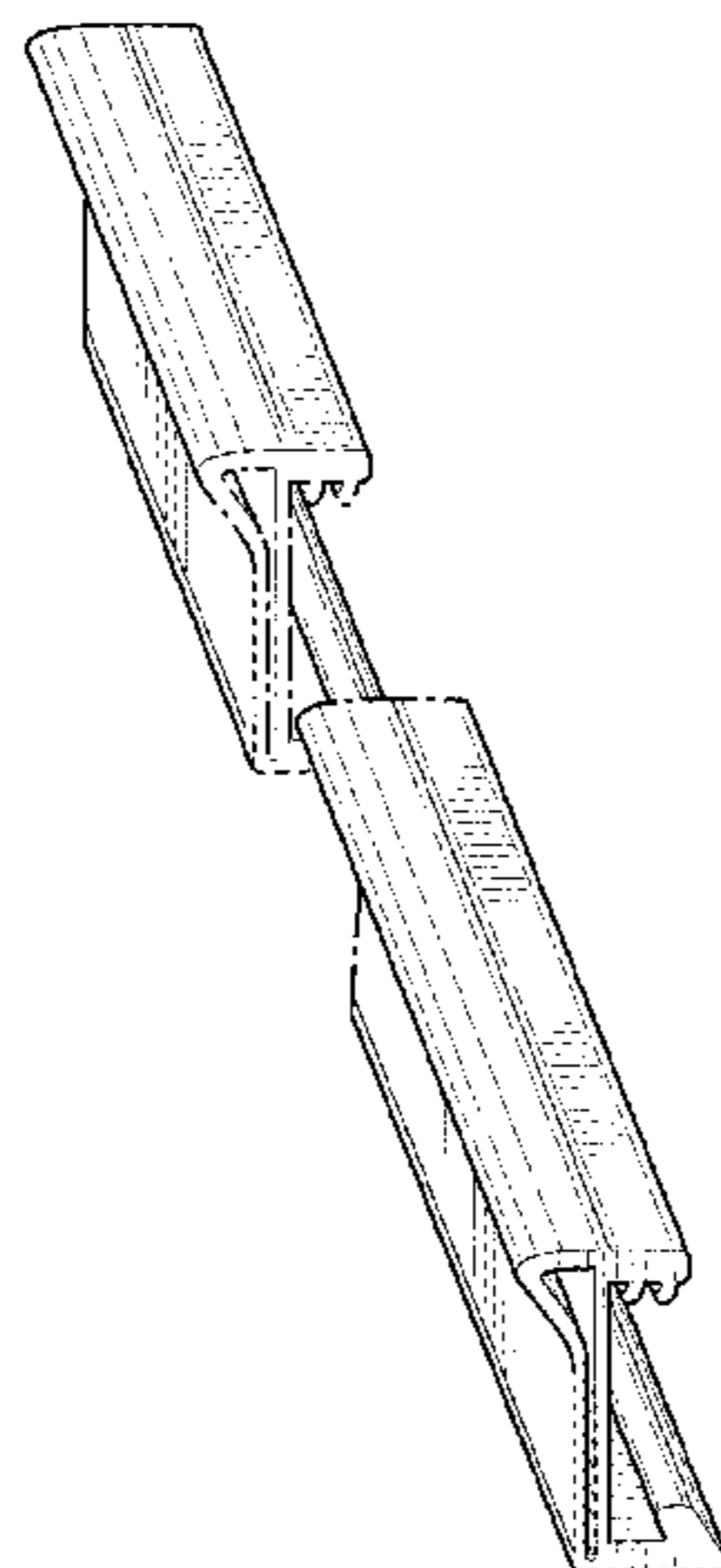

(56)

References Cited

U.S. PATENT DOCUMENTS

2012/0180397 A1* 7/2012 Van Camp E06B 1/70
49/467

OTHER PUBLICATIONS

<https://www.mjbwood.com/wp-content/uploads/2014/07/Brochure-PermaSelect.pdf> Jul. 2014 (Year: 2014).*

Patent Citations for U.S. Pat. No. 6,345,477, accessed Dec. 17, 2017.

Imperial-Products-5H-Sell-Sheet-web, accessed Dec. 18, 2017.

Imperial-Products-12pg-thresholds-brochure-web, accessed Dec. 18, 2017.

* cited by examiner

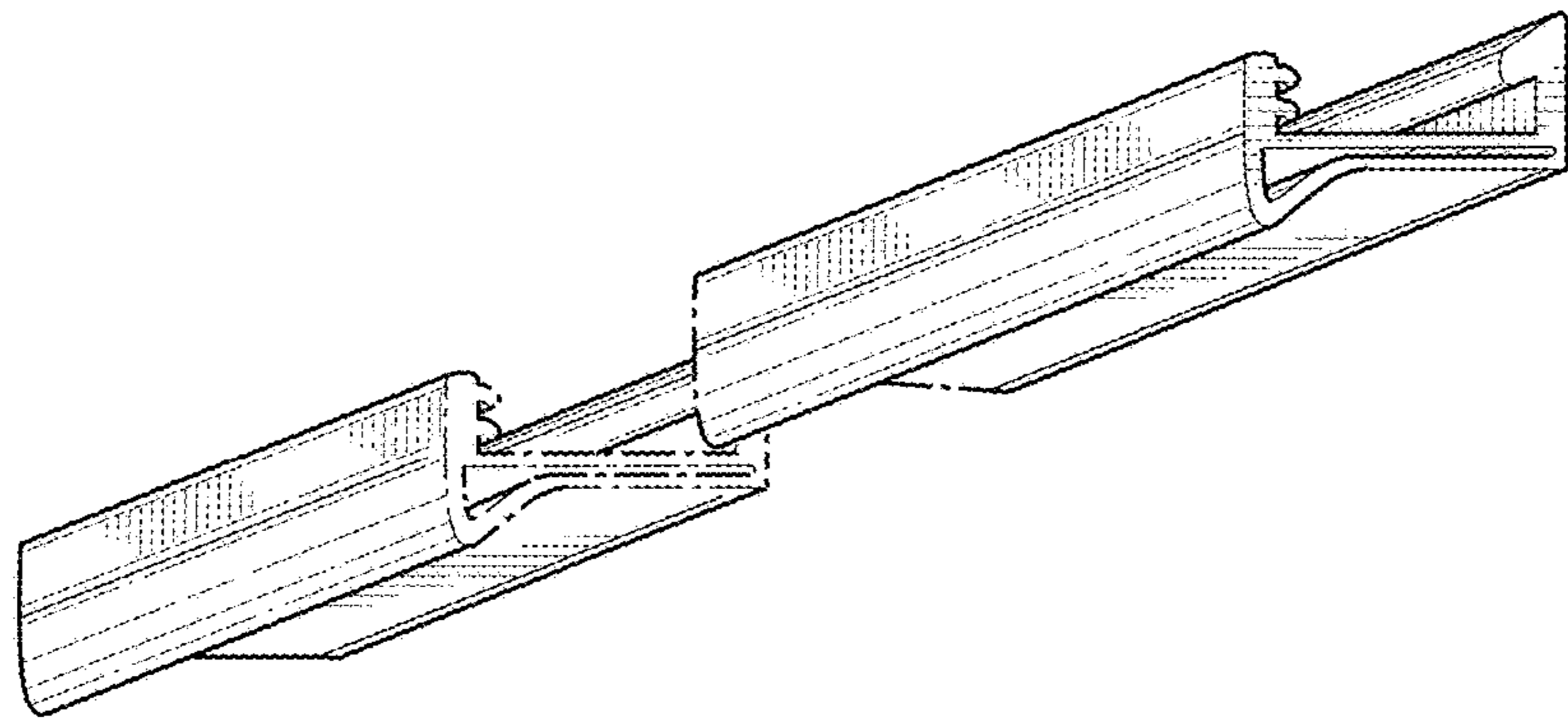

FIG. 1

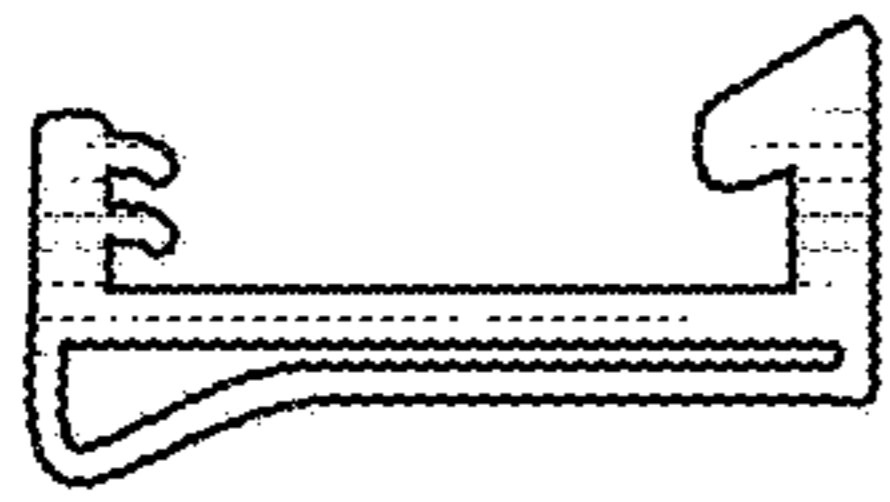

FIG. 2

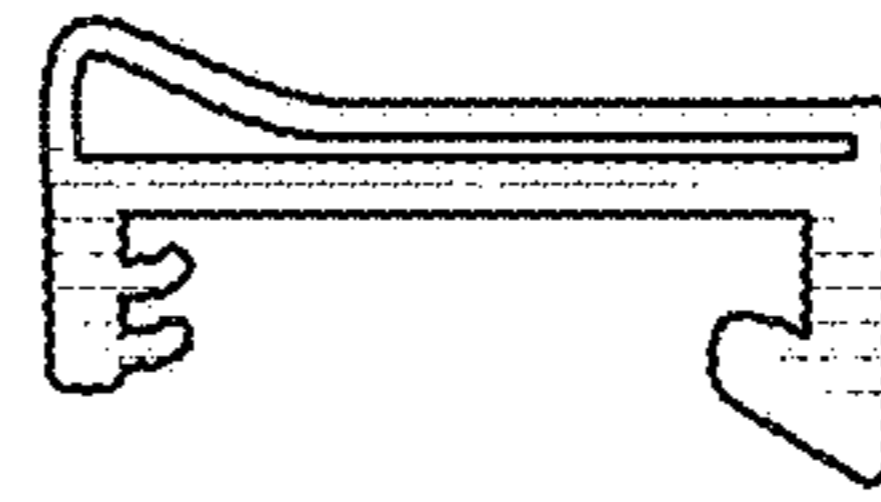

FIG. 3

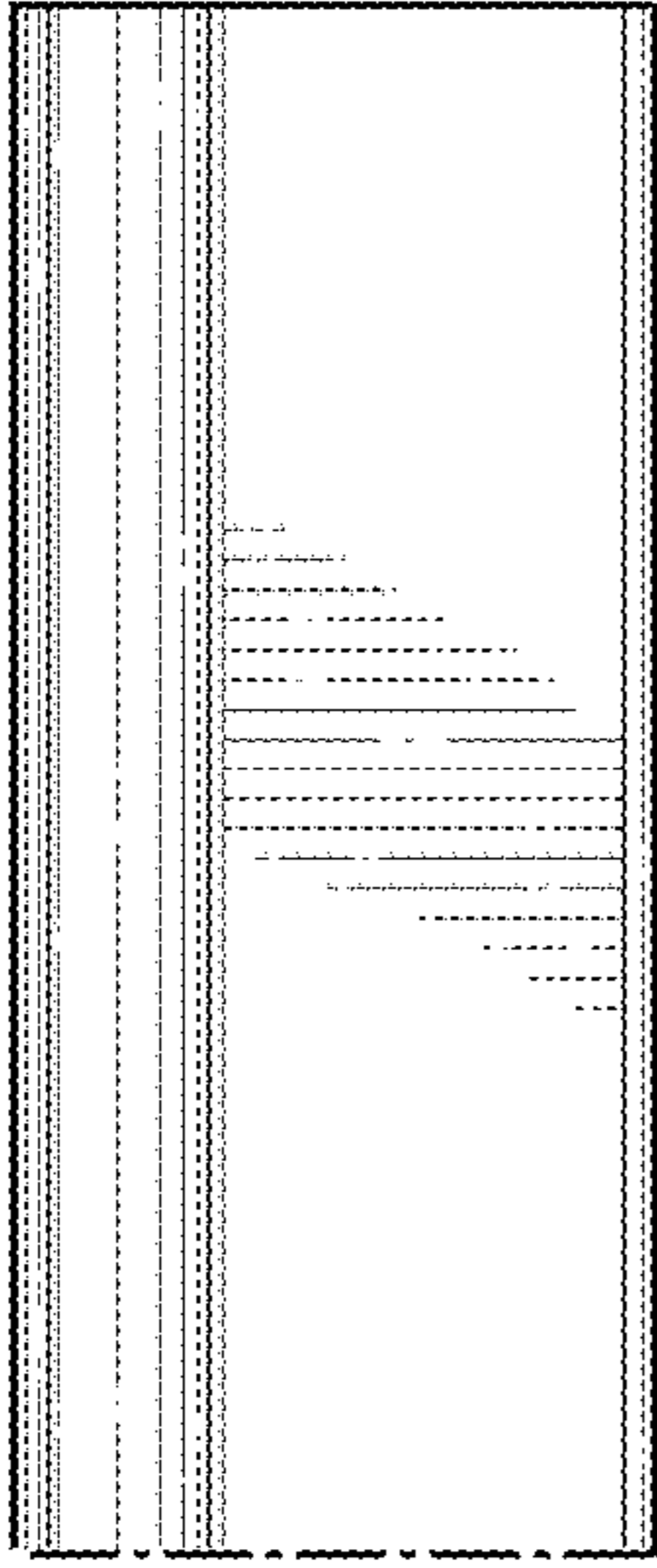

FIG. 4

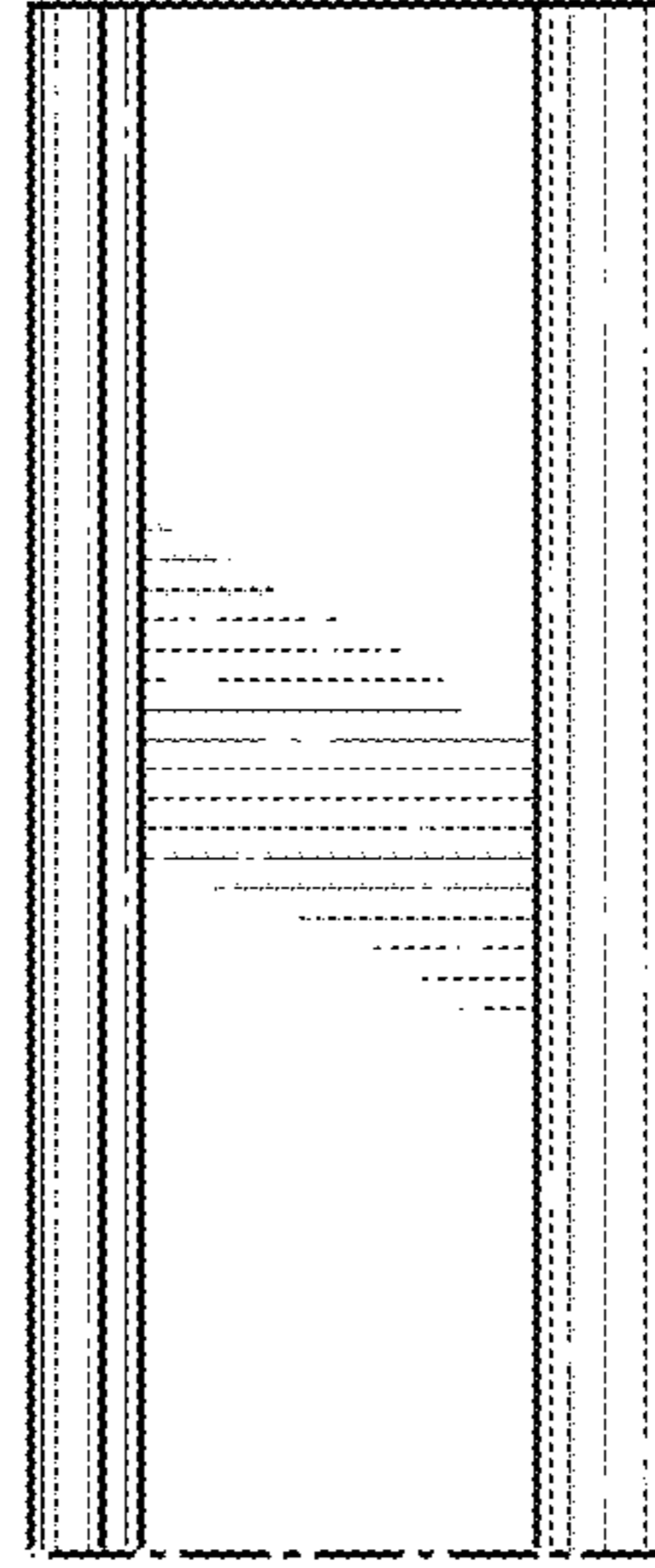
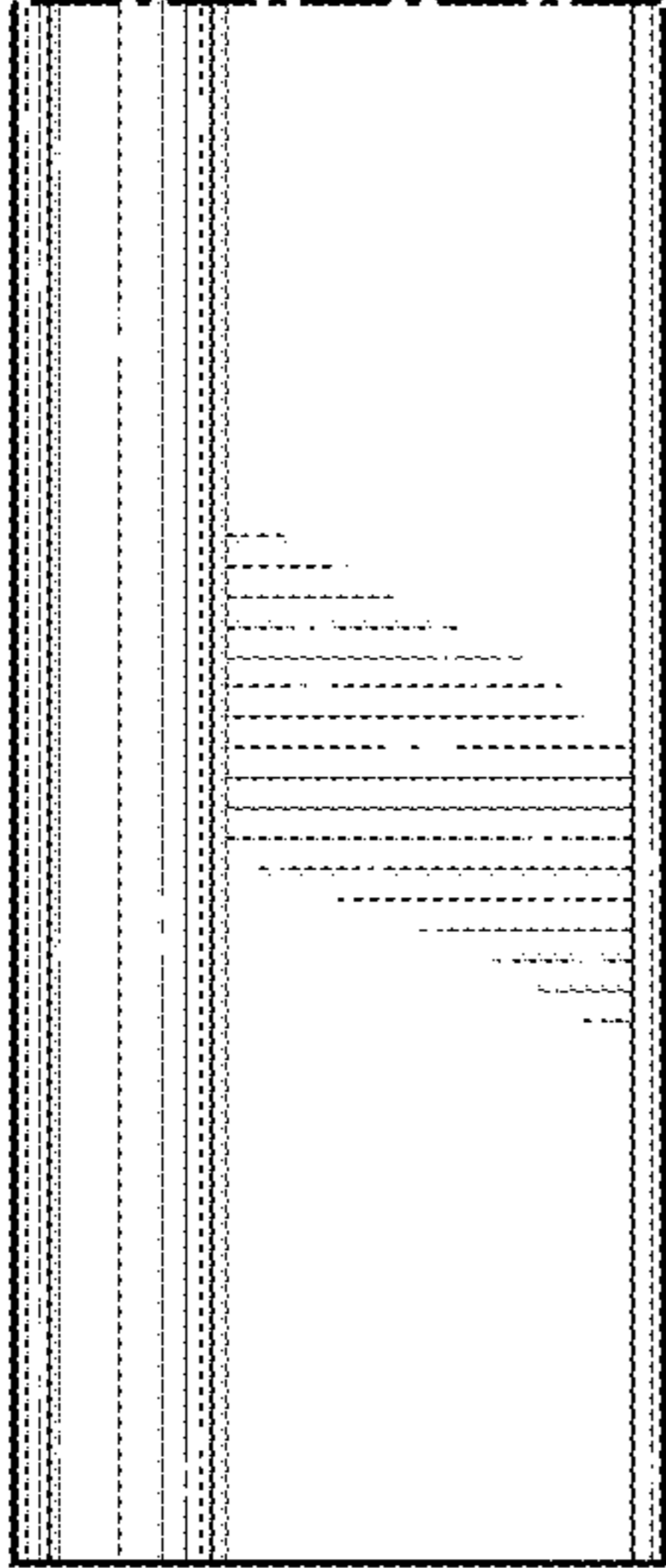
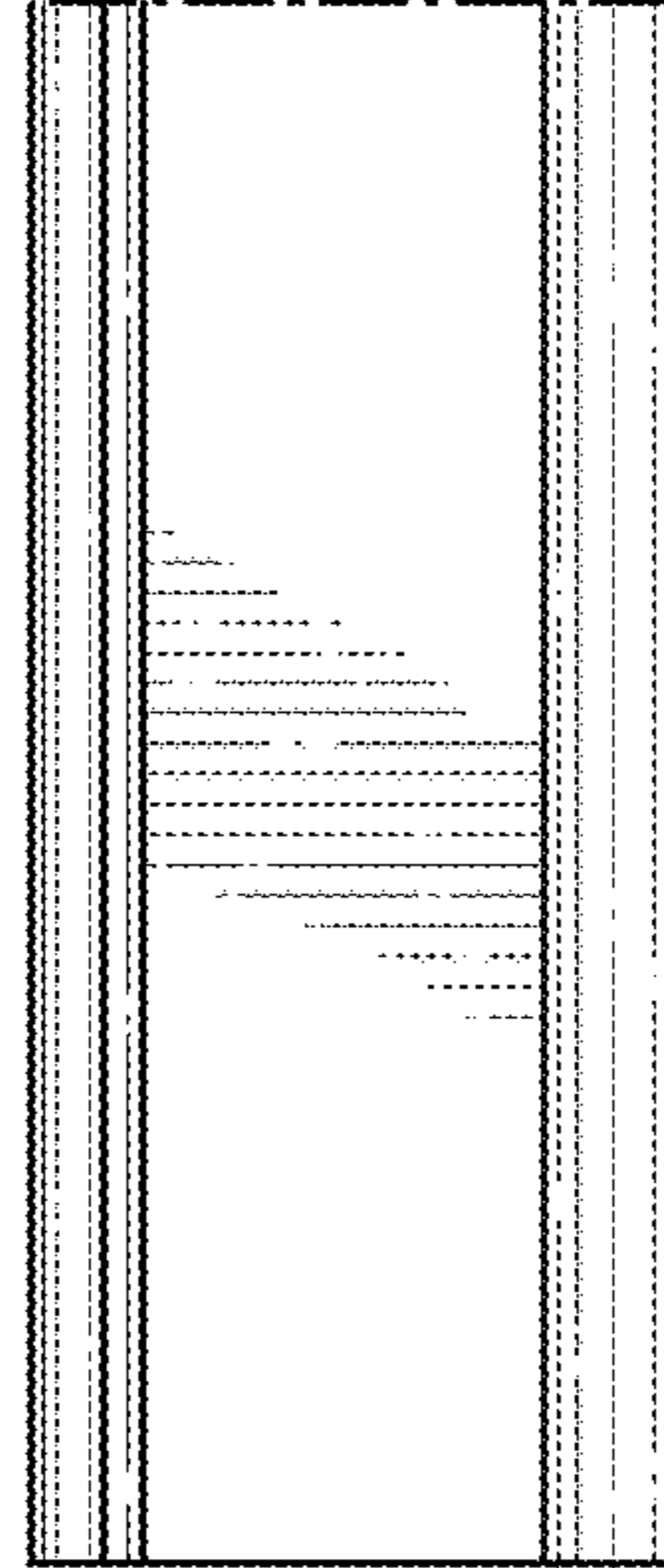

FIG. 5



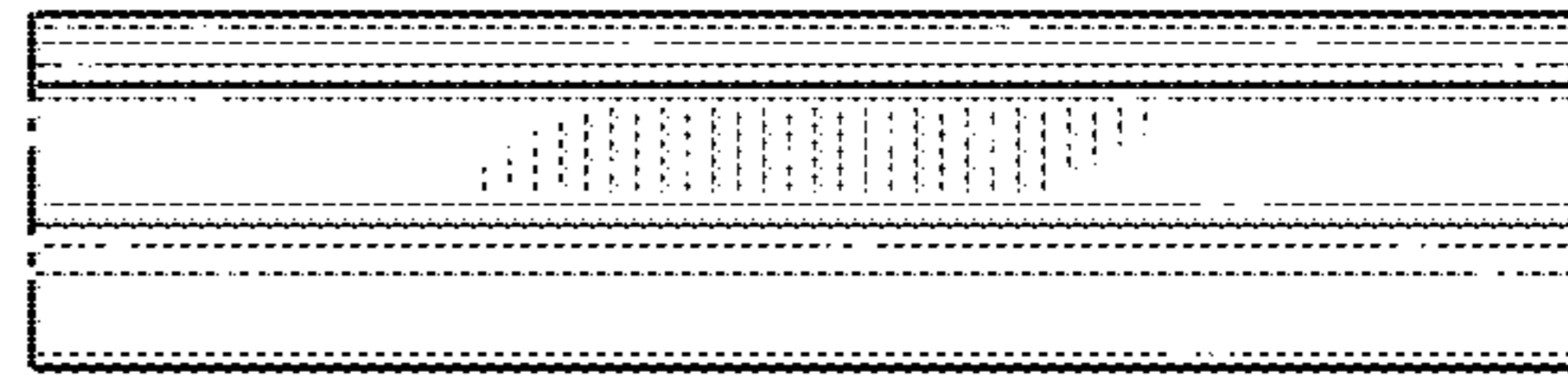
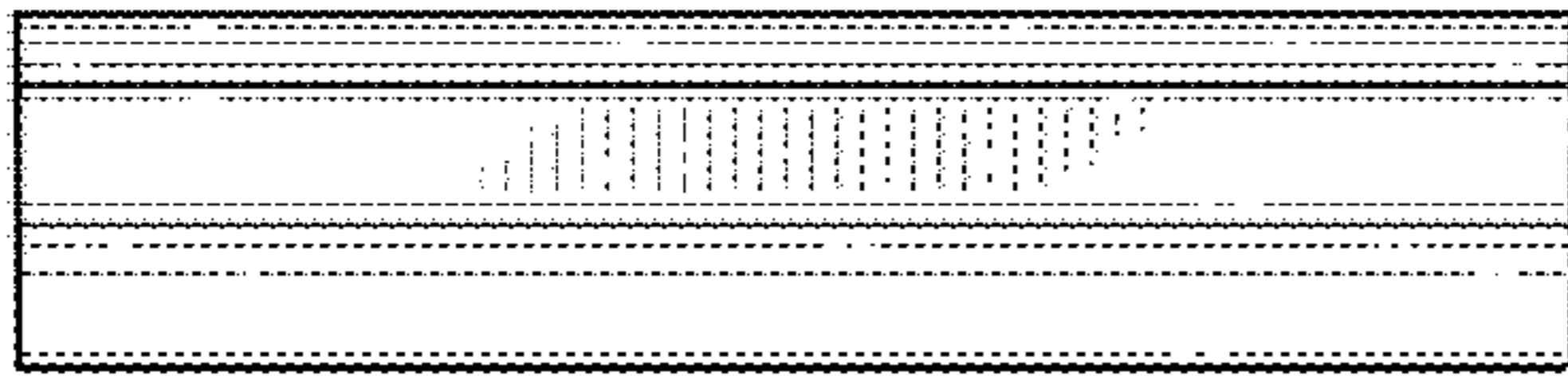

FIG. 7

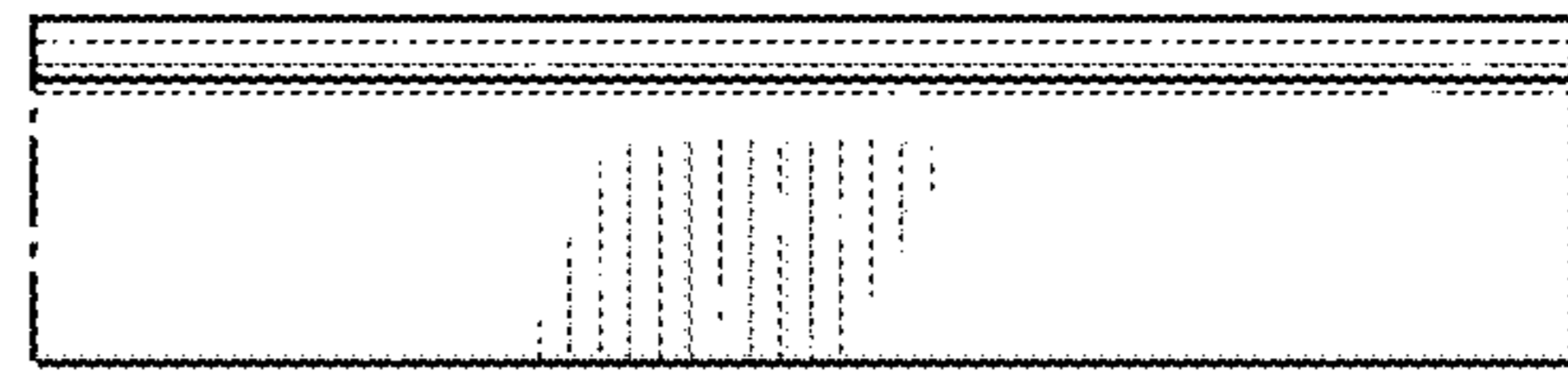
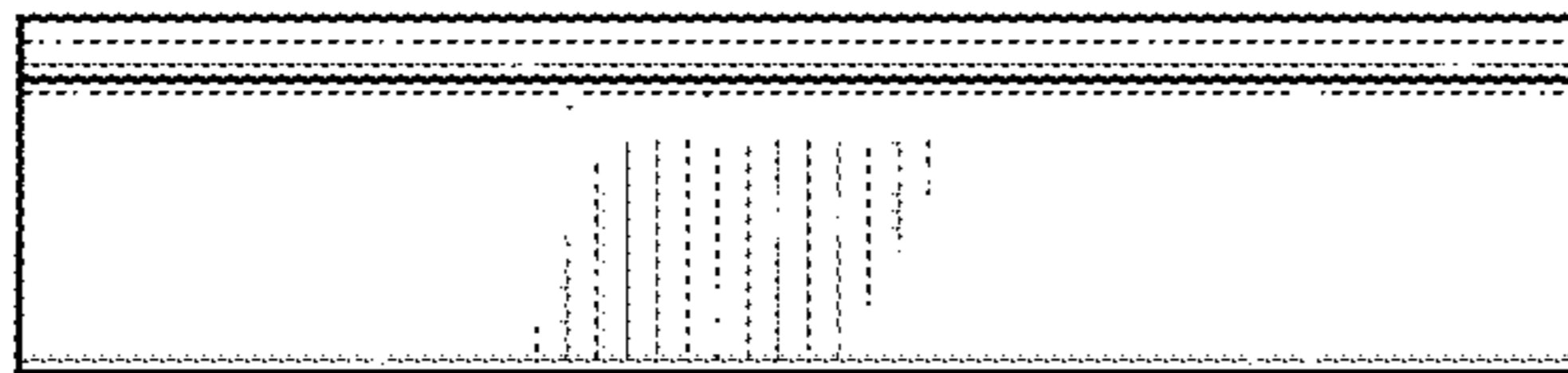

FIG. 6