



US00D857228S

(12) **United States Design Patent**
Kaplan et al.

(10) **Patent No.:** **US D857,228 S**

(45) **Date of Patent:** **** Aug. 20, 2019**

(54) **FULL FLOWCELL CARTRIDGE**

(71) Applicant: **Illumina, Inc.**, San Diego, CA (US)

(72) Inventors: **David Elliott Kaplan**, Carlsbad, CA (US); **Ashish Kumar**, San Diego, CA (US); **Anthony John de Ruyter**, San Diego, CA (US); **Lea Sandra Kobeli**, San Francisco, CA (US); **Edward Wilson Licitra**, San Francisco, CA (US)

(73) Assignee: **Illumina, Inc.**, San Diego, CA (US)

(**) Term: **15 Years**

(21) Appl. No.: **29/589,645**

(22) Filed: **Jan. 3, 2017**

(51) **LOC (12) Cl.** **24-01**

(52) **U.S. Cl.**
USPC **D24/225**

(58) **Field of Classification Search**
USPC D24/216, 223–233, 186, 107; D10/81
(Continued)

(56) **References Cited**

U.S. PATENT DOCUMENTS

D633,209 S * 2/2011 Boessneck D24/169
D668,350 S * 10/2012 Rowley D24/225
(Continued)

FOREIGN PATENT DOCUMENTS

TW D182357 4/2017

OTHER PUBLICATIONS

Illumina™ NextSeq™ Flowcell Cartridge figures, dated Jan. 3, 2016, 6 pgs.

(Continued)

Primary Examiner — Anhdao Doan

(74) *Attorney, Agent, or Firm* — Weaver Austin Villeneuve & Sampson LLP

(57) **CLAIM**

We claim the ornamental design for a full flowcell cartridge, as shown and described.

DESCRIPTION

FIG. 1 is a top view of a first embodiment of a full flowcell cartridge.

FIG. 2 is a bottom view of the first embodiment of the full flowcell cartridge.

FIG. 3 is a left side view of the first embodiment of the full flowcell cartridge.

FIG. 4 is a right side view of the first embodiment of the full flowcell cartridge.

FIG. 5 is a front view of the first embodiment of the full flowcell cartridge.

FIG. 6 is a rear view of the first embodiment of the full flowcell cartridge.

FIG. 7 is an isometric view of the first embodiment of the full flowcell cartridge.

FIG. 8 is an isometric view of the bottom of the first embodiment of the full flowcell cartridge.

FIG. 9 is a top view of a second embodiment of a full flowcell cartridge.

FIG. 10 is a bottom view of the second embodiment of the full flowcell cartridge.

FIG. 11 is a left side view of the second embodiment of the full flowcell cartridge.

FIG. 12 is a right side view of the second embodiment of the full flowcell cartridge.

FIG. 13 is a front view of the second embodiment of the full flowcell cartridge.

FIG. 14 is a rear view of the second embodiment of the full flowcell cartridge.

FIG. 15 is an isometric view of the second embodiment of the full flowcell cartridge.

FIG. 16 is an isometric view of the bottom of the second embodiment of the full flowcell cartridge.

FIG. 17 is a top view of a third embodiment of a full flowcell cartridge.

(Continued)

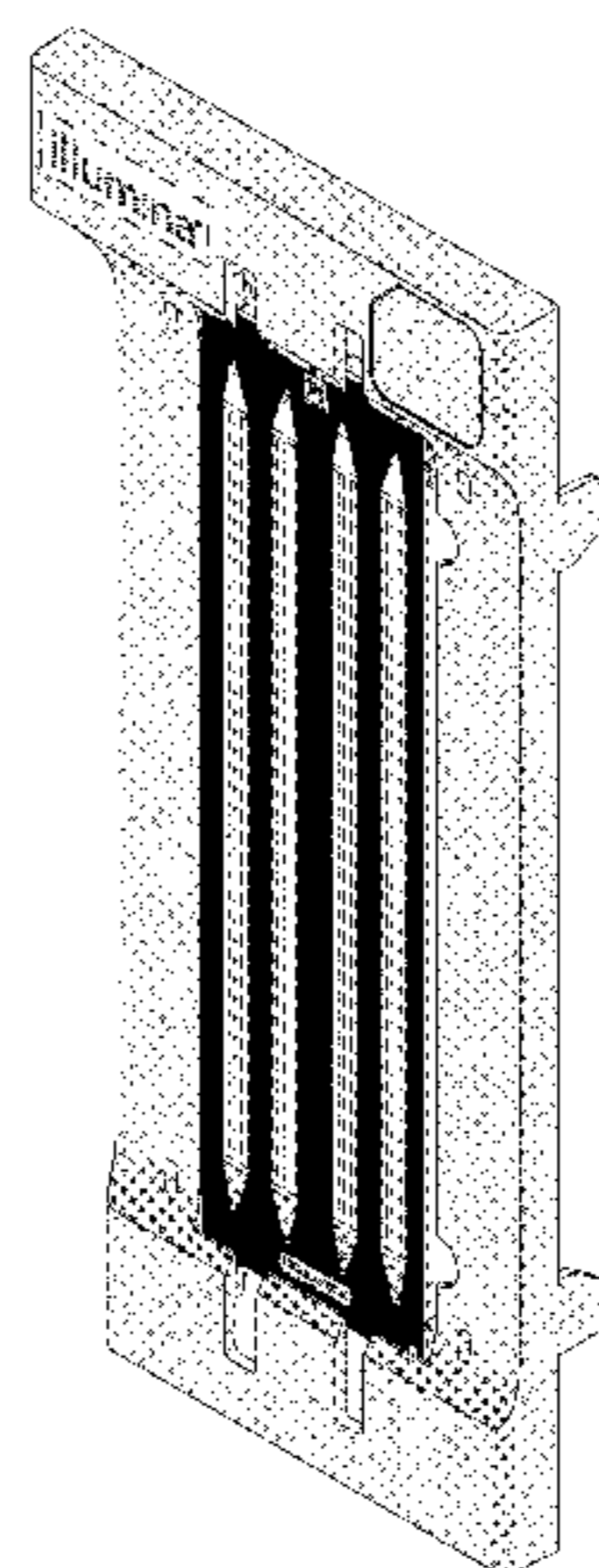

FIG. 18 is a bottom view of the third embodiment of the full flowcell cartridge.
 FIG. 19 is a left side view of the third embodiment of the full flowcell cartridge.
 FIG. 20 is a right side view of the third embodiment of the full flowcell cartridge.
 FIG. 21 is a front view of the third embodiment of the full flowcell cartridge.
 FIG. 22 is a rear view of the third embodiment of the full flowcell cartridge.
 FIG. 23 is an isometric view of the third embodiment of the full flowcell cartridge.
 FIG. 24 is an isometric view of the bottom of the third embodiment of the full flowcell cartridge.
 FIG. 25 is a top view of a fourth embodiment of a full flowcell cartridge.
 FIG. 26 is a bottom view of the fourth embodiment of the full flowcell cartridge.
 FIG. 27 is a left side view of the fourth embodiment of the full flowcell cartridge.
 FIG. 28 is a right side view of the fourth embodiment of the full flowcell cartridge.
 FIG. 29 is a front view of the fourth embodiment of the full flowcell cartridge.
 FIG. 30 is a rear view of the fourth embodiment of the full flowcell cartridge.
 FIG. 31 is an isometric view of the fourth embodiment of the full flowcell cartridge; and,
 FIG. 32 is an isometric view of the bottom of the fourth embodiment of the full flowcell cartridge.

The dash-dot-dash lines represent the bounds of the claim, and all other broken lines represent environmental subject matter. None of the broken lines form part of the claimed design.

1 Claim, 20 Drawing Sheets

(58) **Field of Classification Search**
 CPC B01L 3/5027; B01L 3/502707; B01L 9/52;
 B01L 9/523; B01L 9/527; B01L
 2300/0609; B01L 2300/0809; B01L
 2300/0877; B01L 2200/027
 See application file for complete search history.

(56) **References Cited**

U.S. PATENT DOCUMENTS

| | | | | | |
|--------------|----|---|---------|----------------|---------------|
| D734,482 | S | * | 7/2015 | Peterman | D24/216 |
| D787,700 | S | * | 5/2017 | Dunaway | D24/225 |
| D812,767 | S | * | 3/2018 | Osmus | D24/225 |
| D831,224 | S | * | 10/2018 | Hsu | D24/225 |
| 2016/0281150 | A1 | * | 9/2016 | Rawlings | C12Q 1/6837 |
| 2018/0304260 | A1 | * | 10/2018 | Thomas | B01L 3/502723 |

OTHER PUBLICATIONS

U.S. Appl. No. 29/589,646, filed Jan. 3, 2017, Kaplan et al.
 U.S. Appl. No. 29/632,284, filed Jan. 5, 2018, Kaplan et al.

* cited by examiner

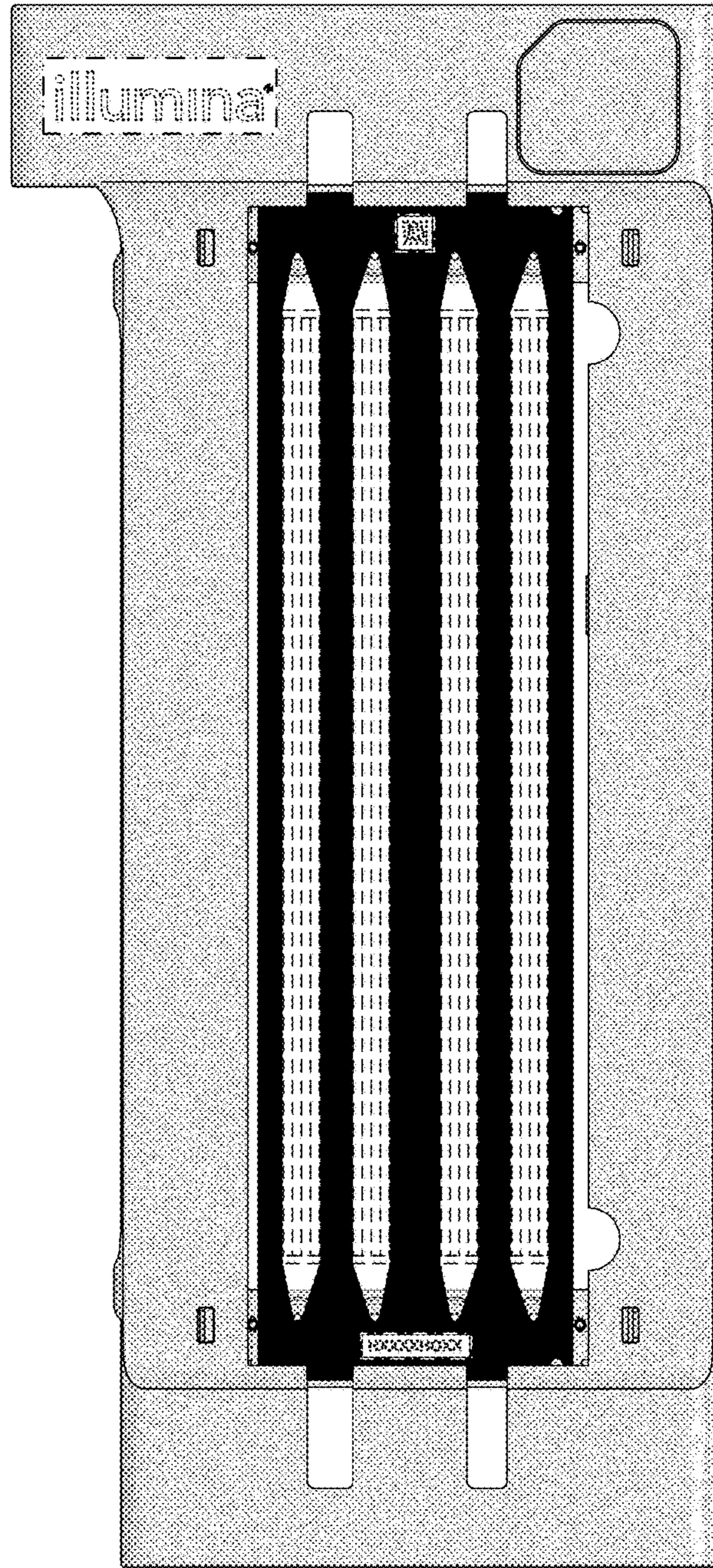

Figure 1

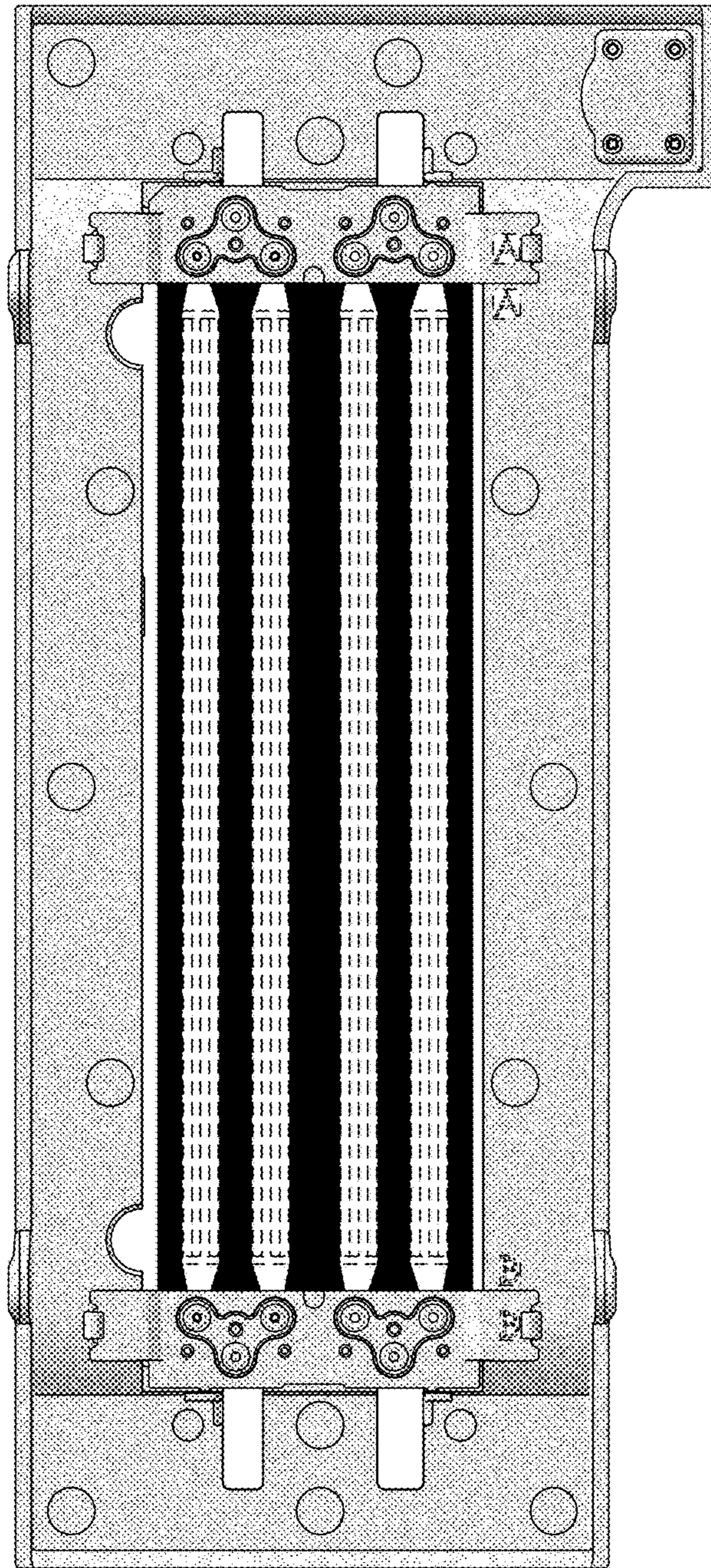

Figure 2

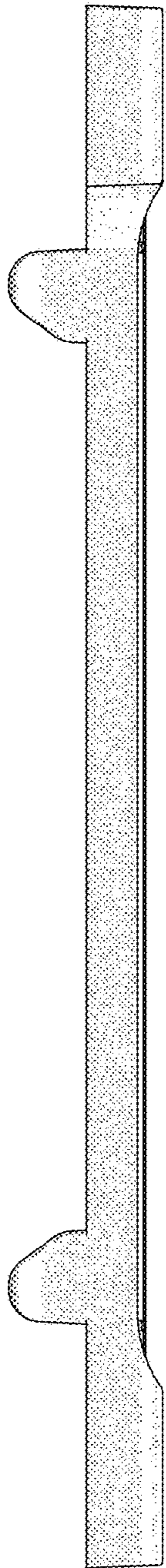

Figure 3

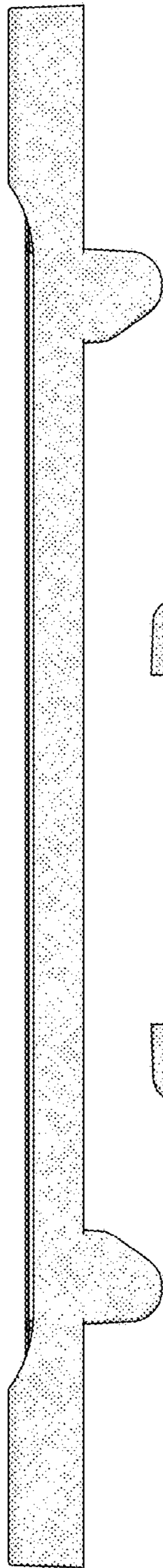

Figure 4

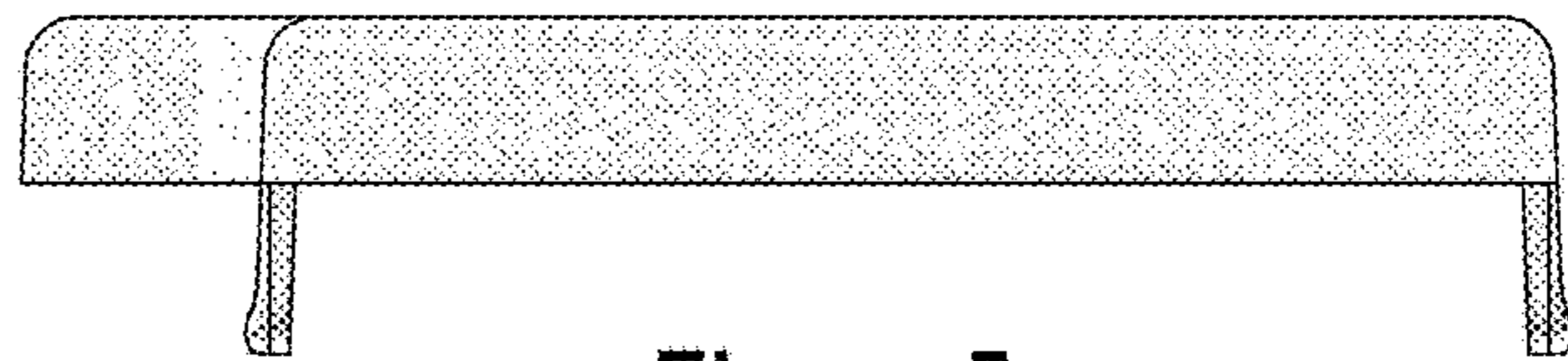

Figure 5

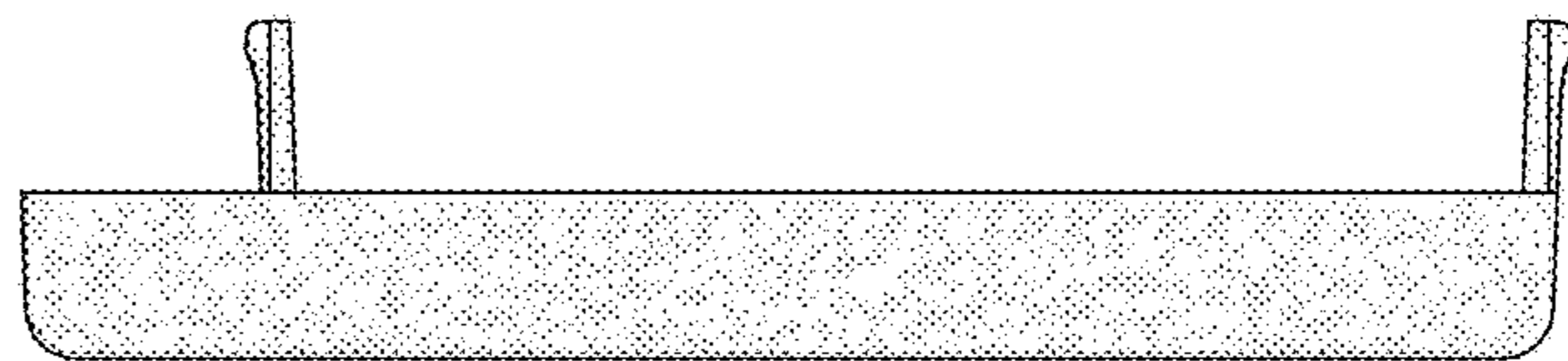

Figure 6

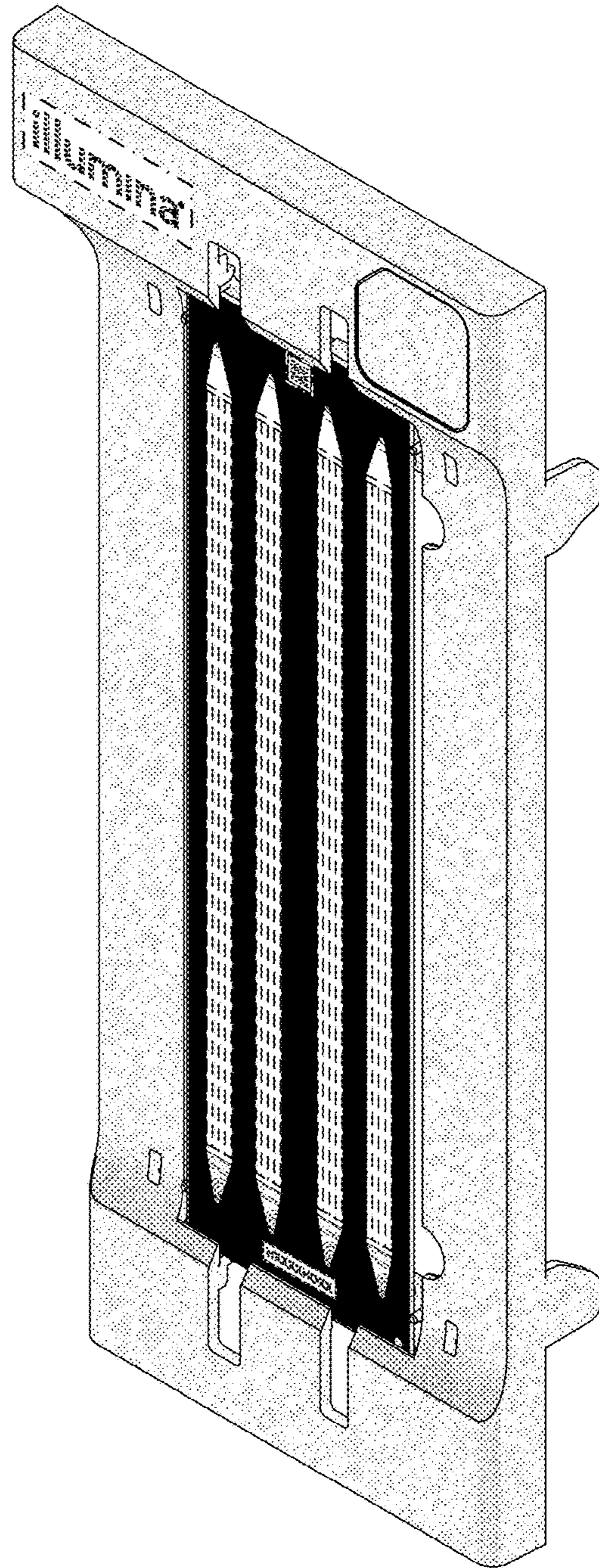

Figure 7

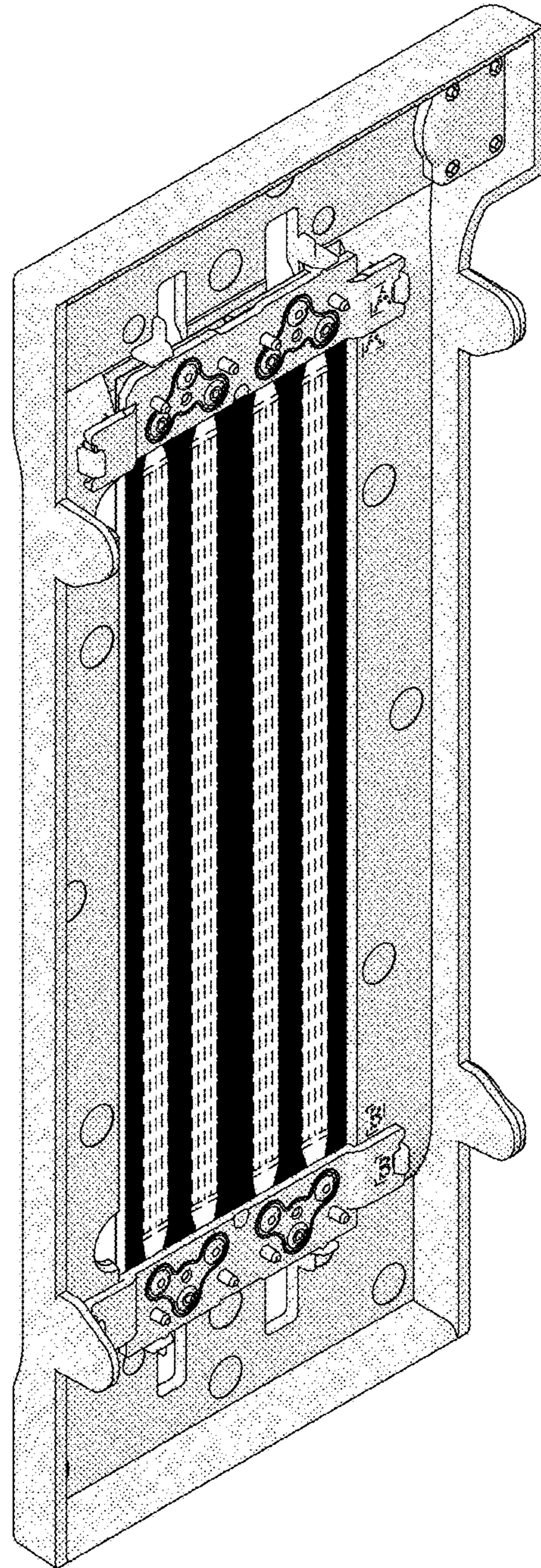

Figure 8

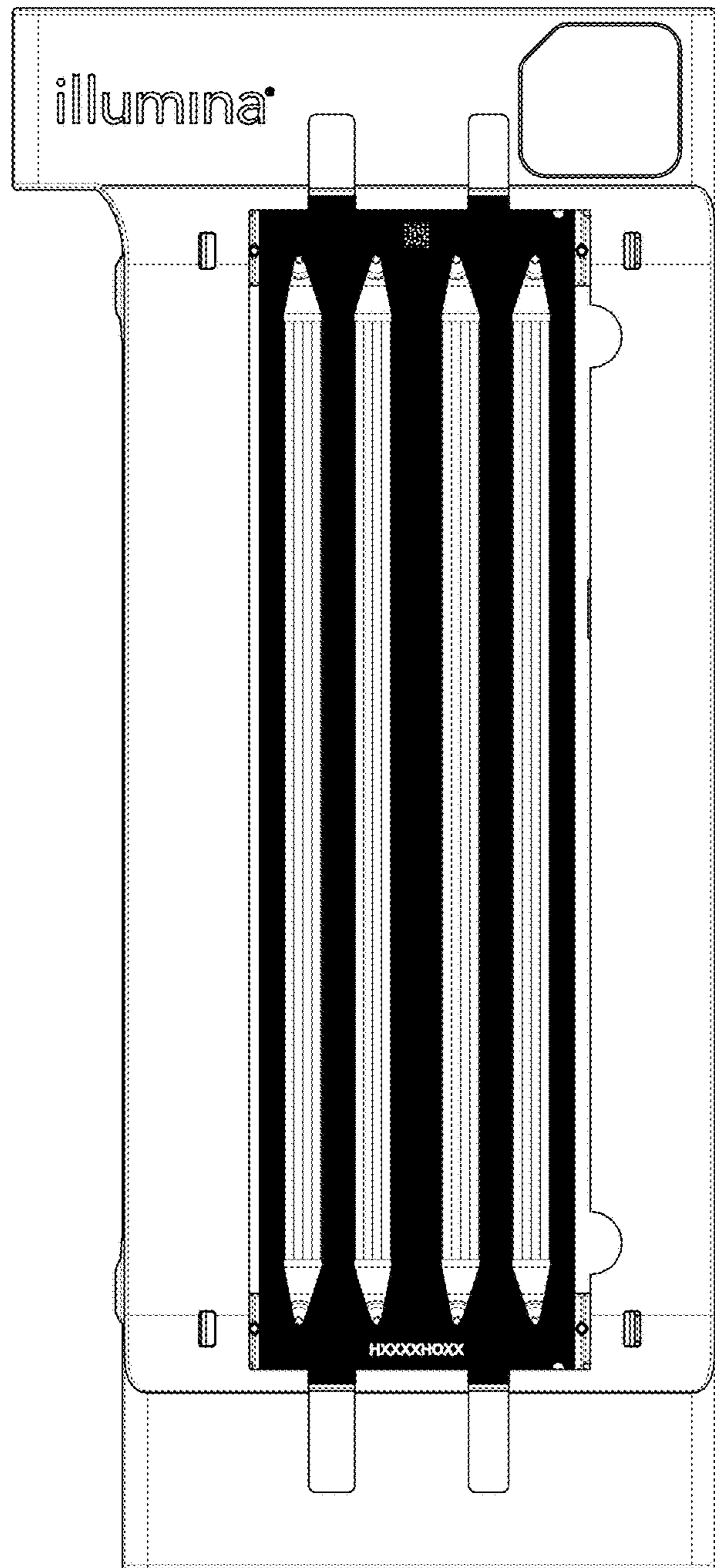

Figure 9

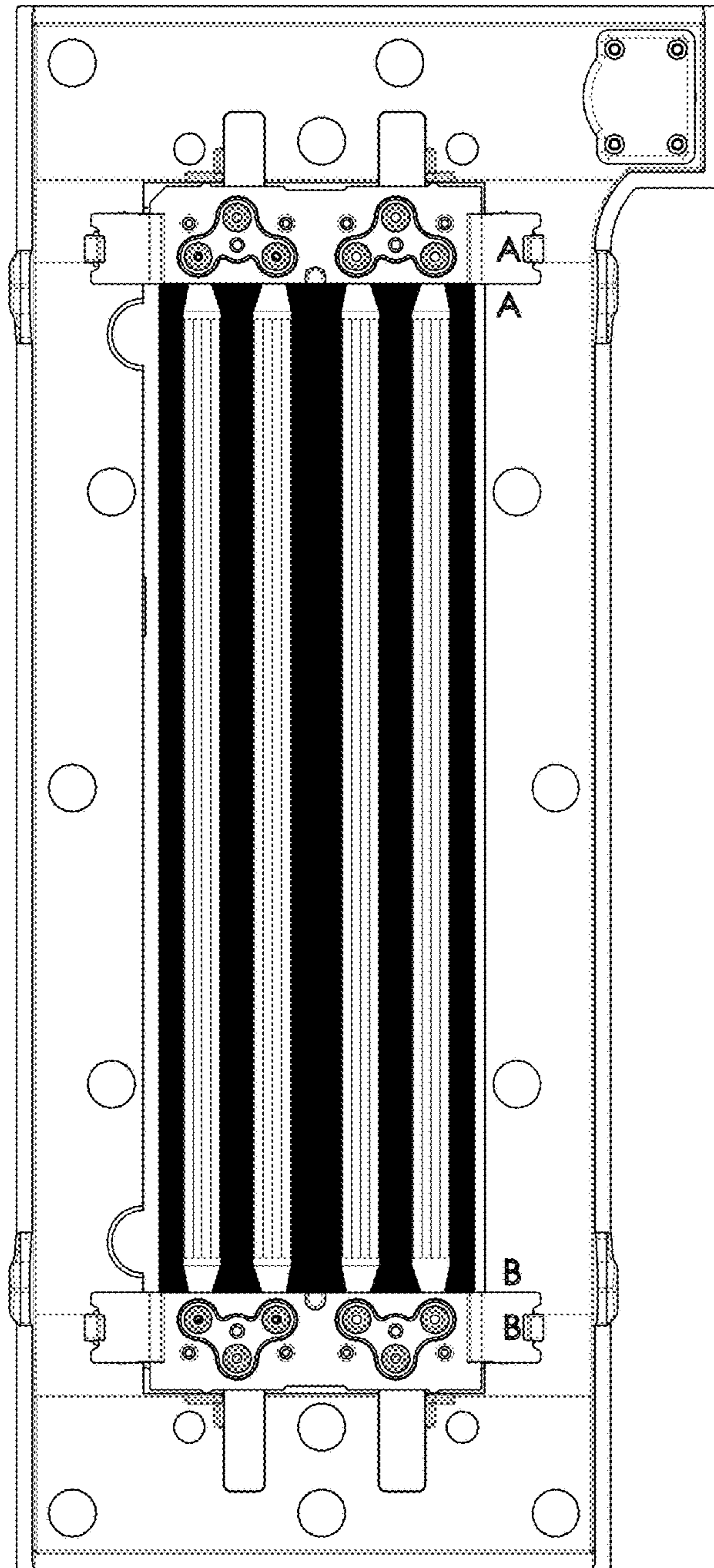

Figure 10

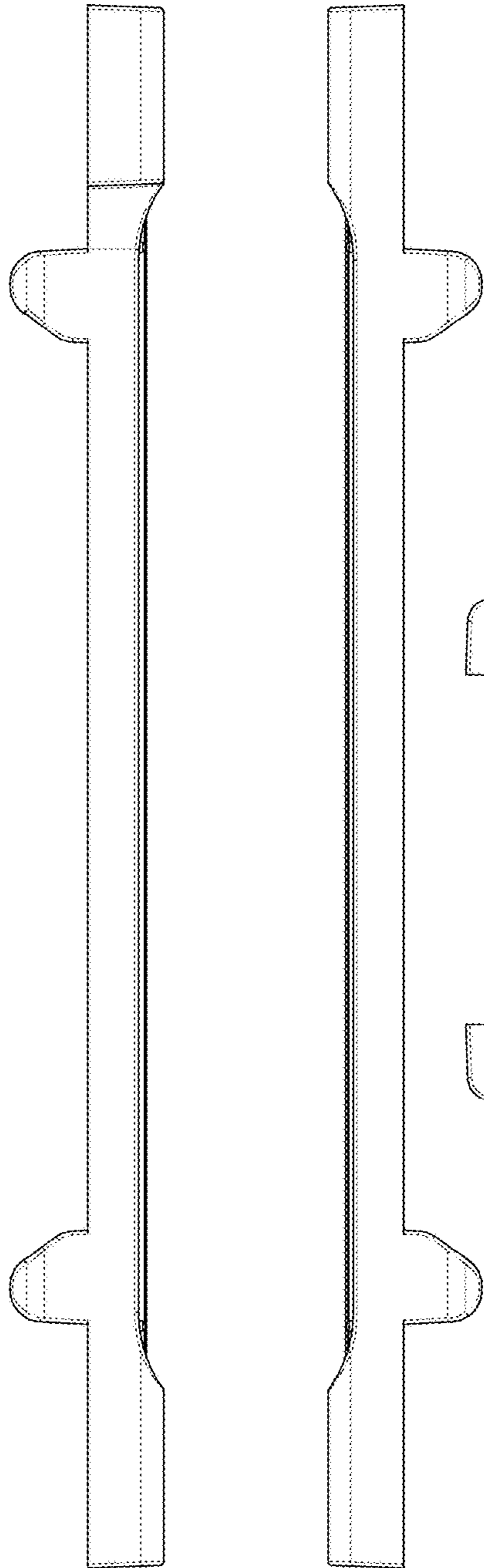

Figure 11

Figure 12

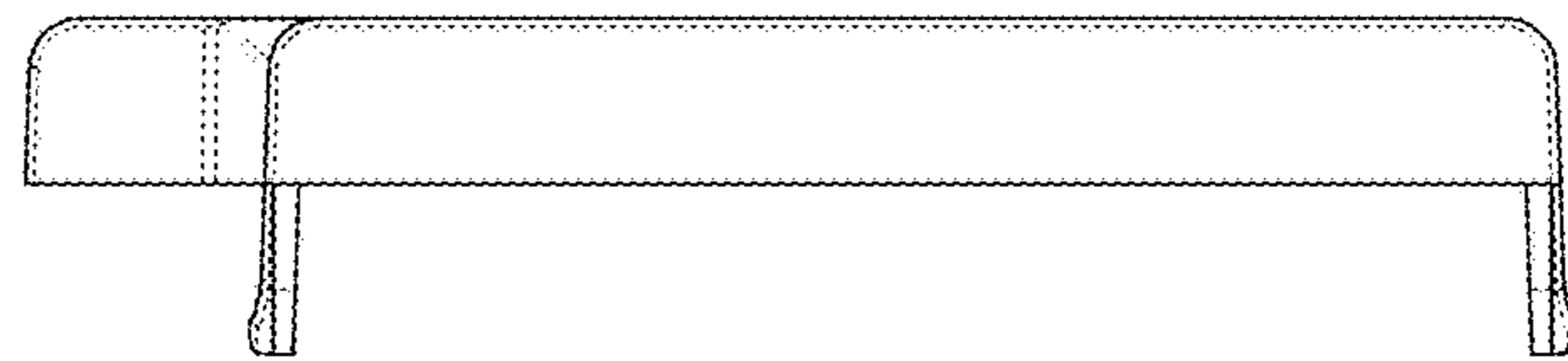

Figure 13

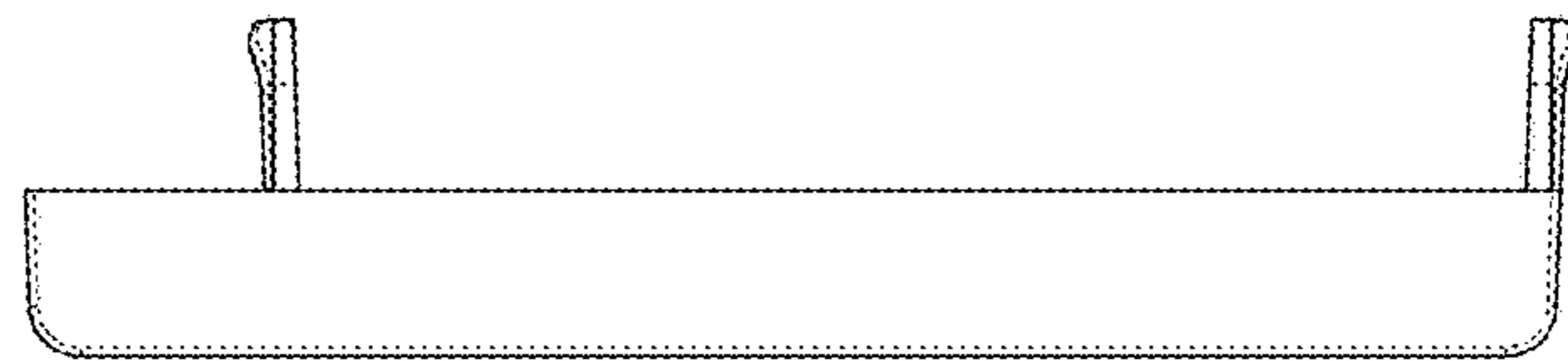

Figure 14

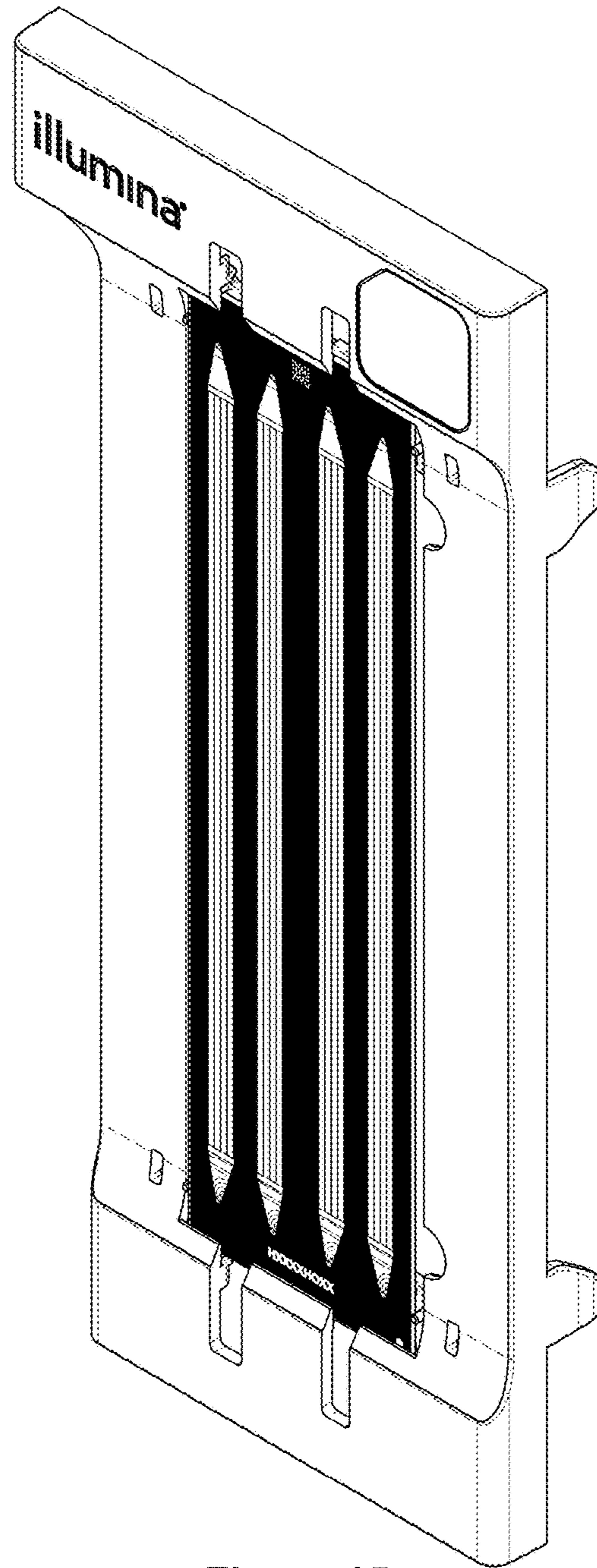

Figure 15

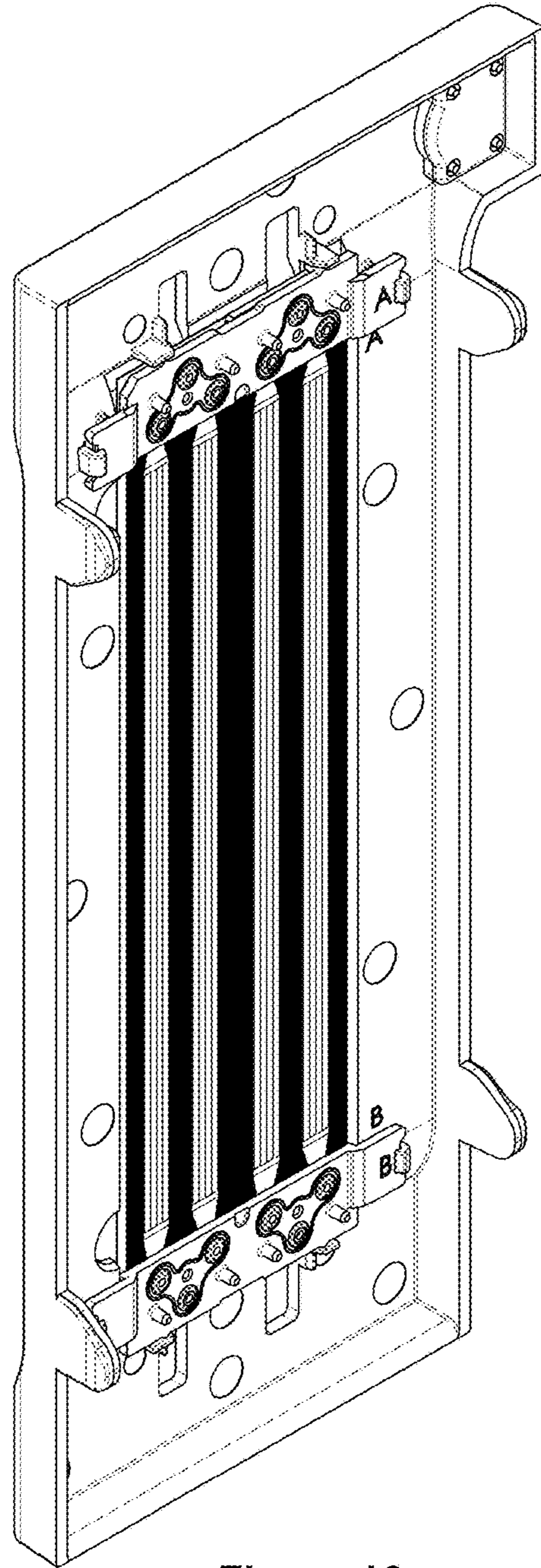

Figure 16

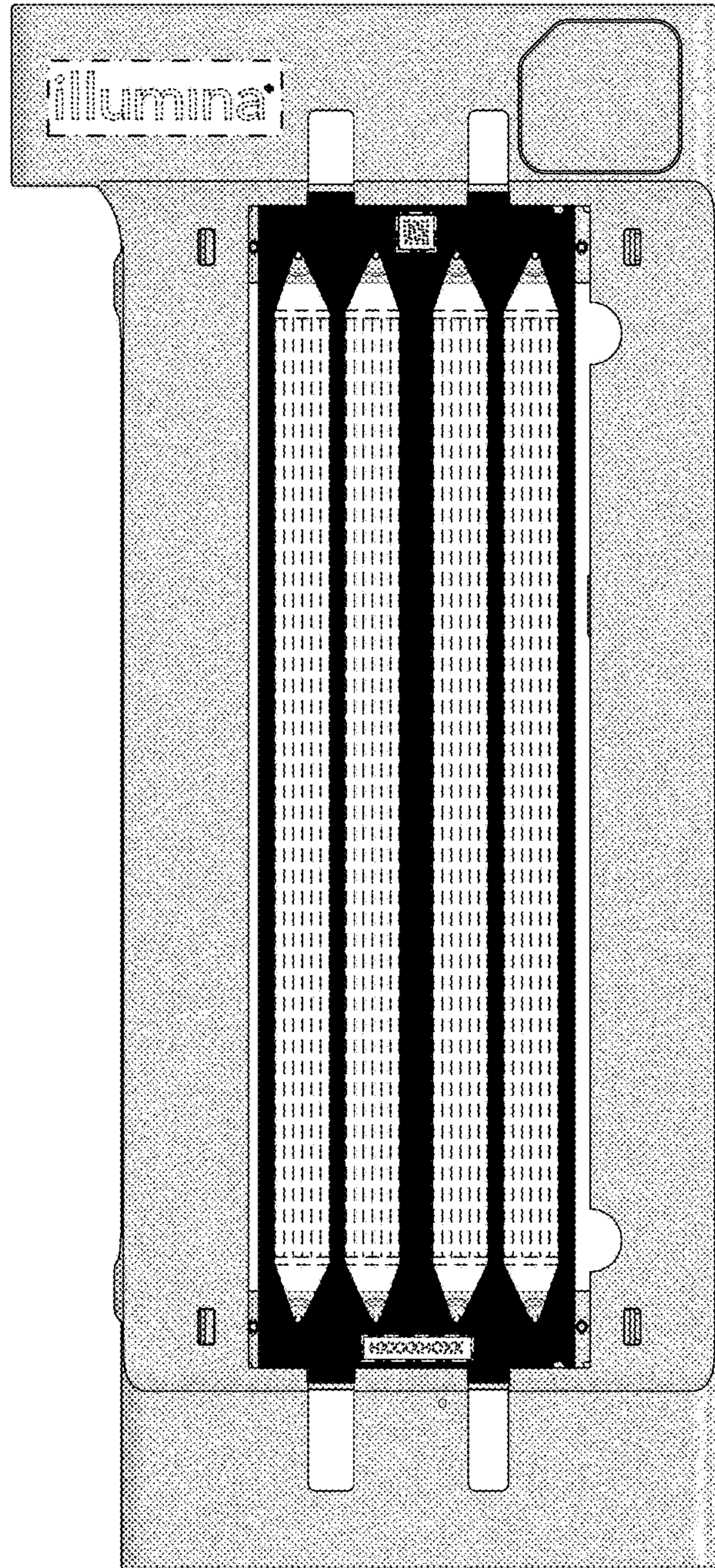

Figure 17

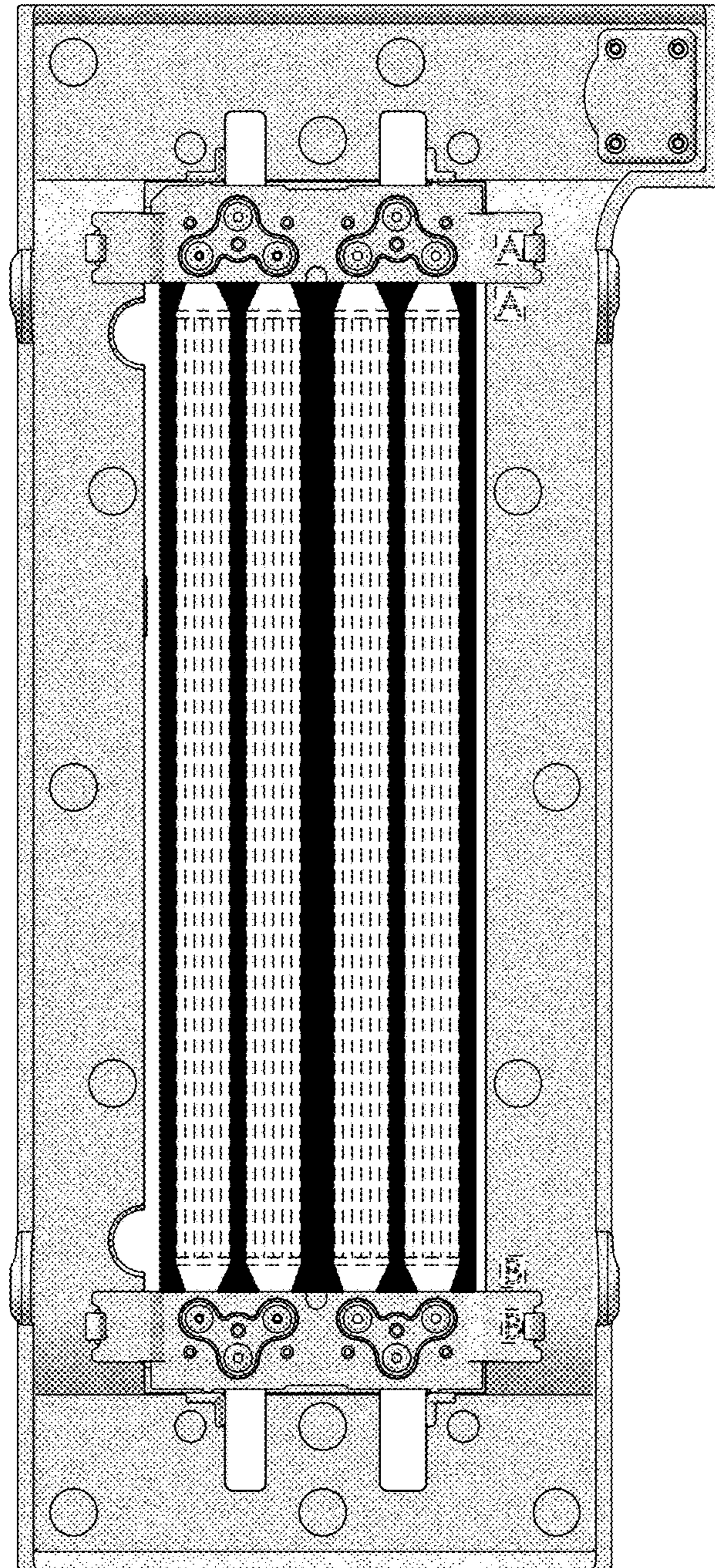

Figure 18

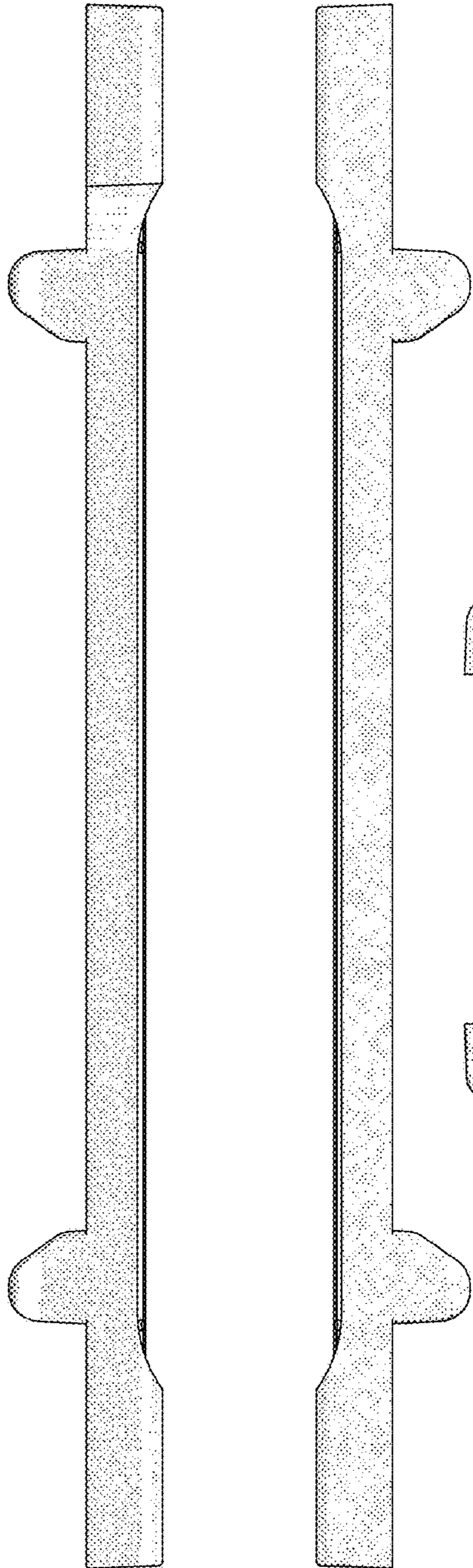

Figure 19

Figure 20

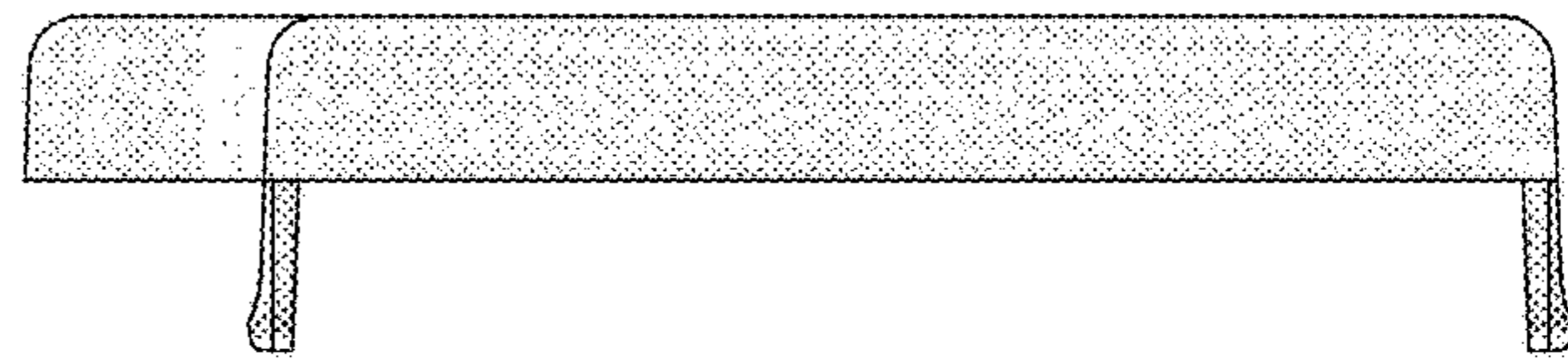

Figure 21

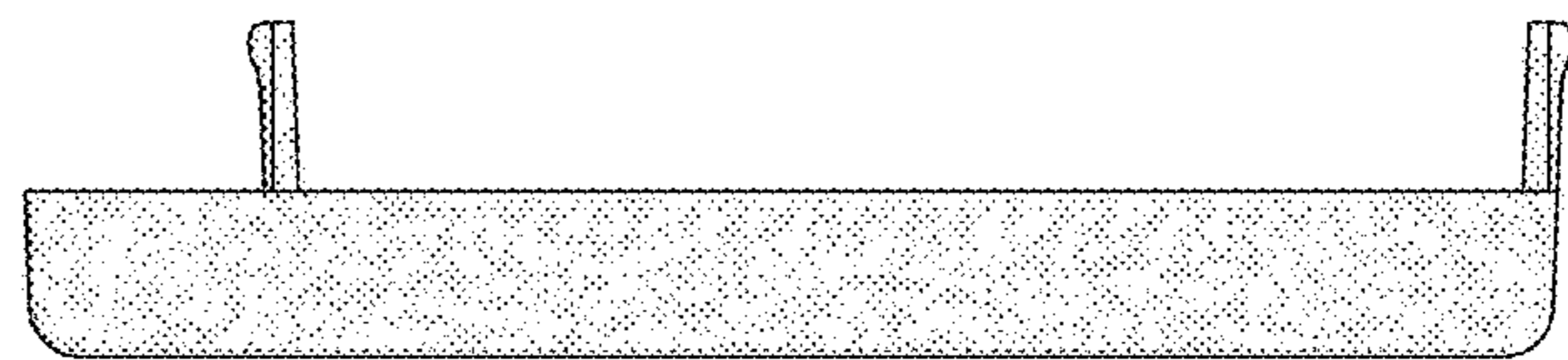

Figure 22

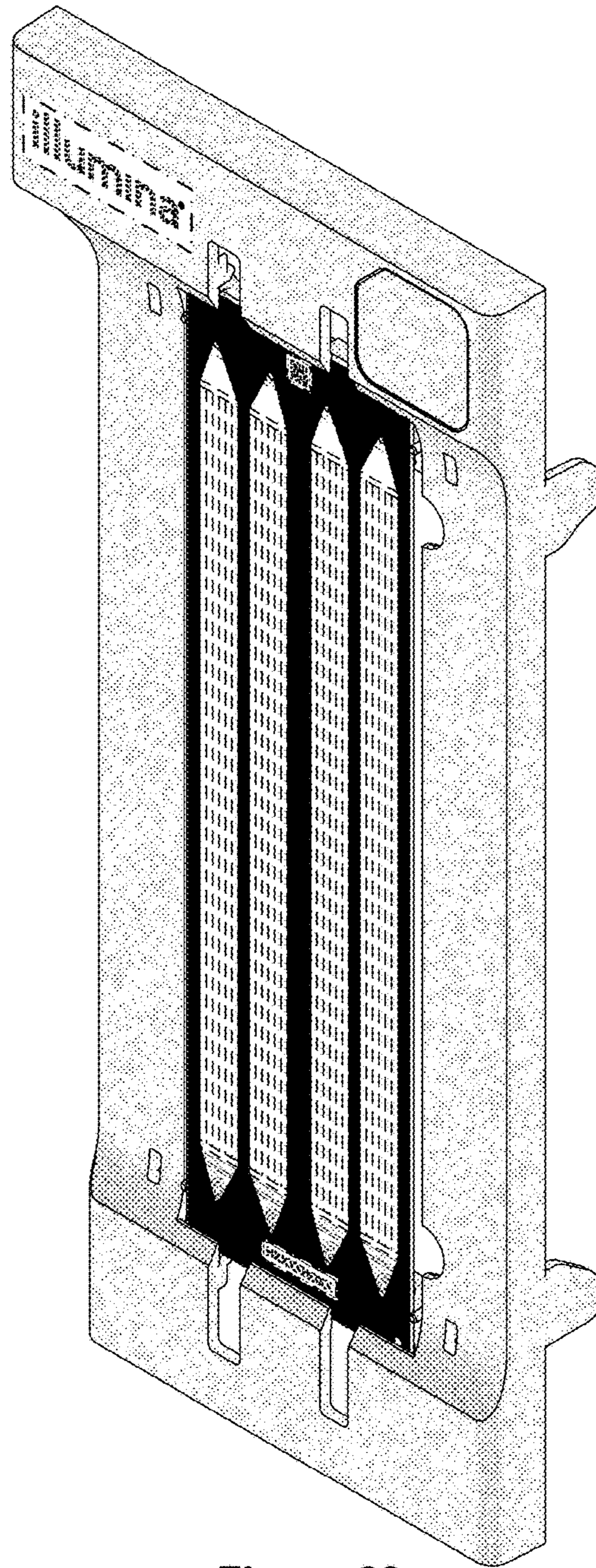

Figure 23

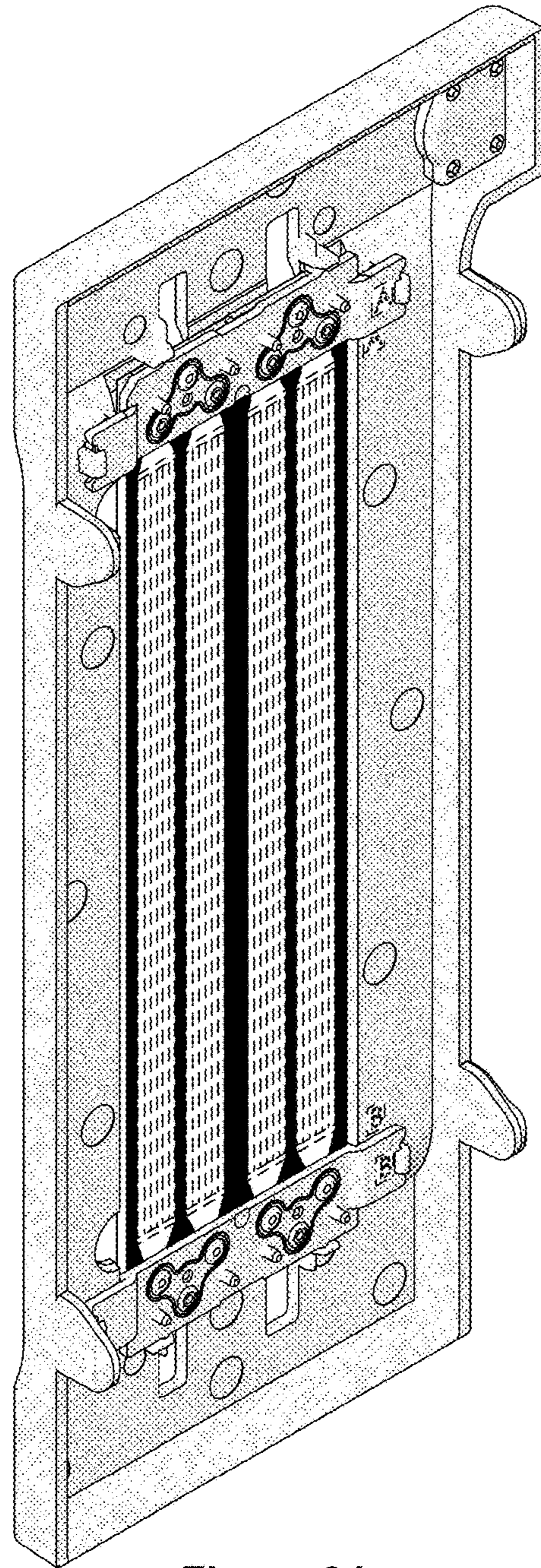

Figure 24

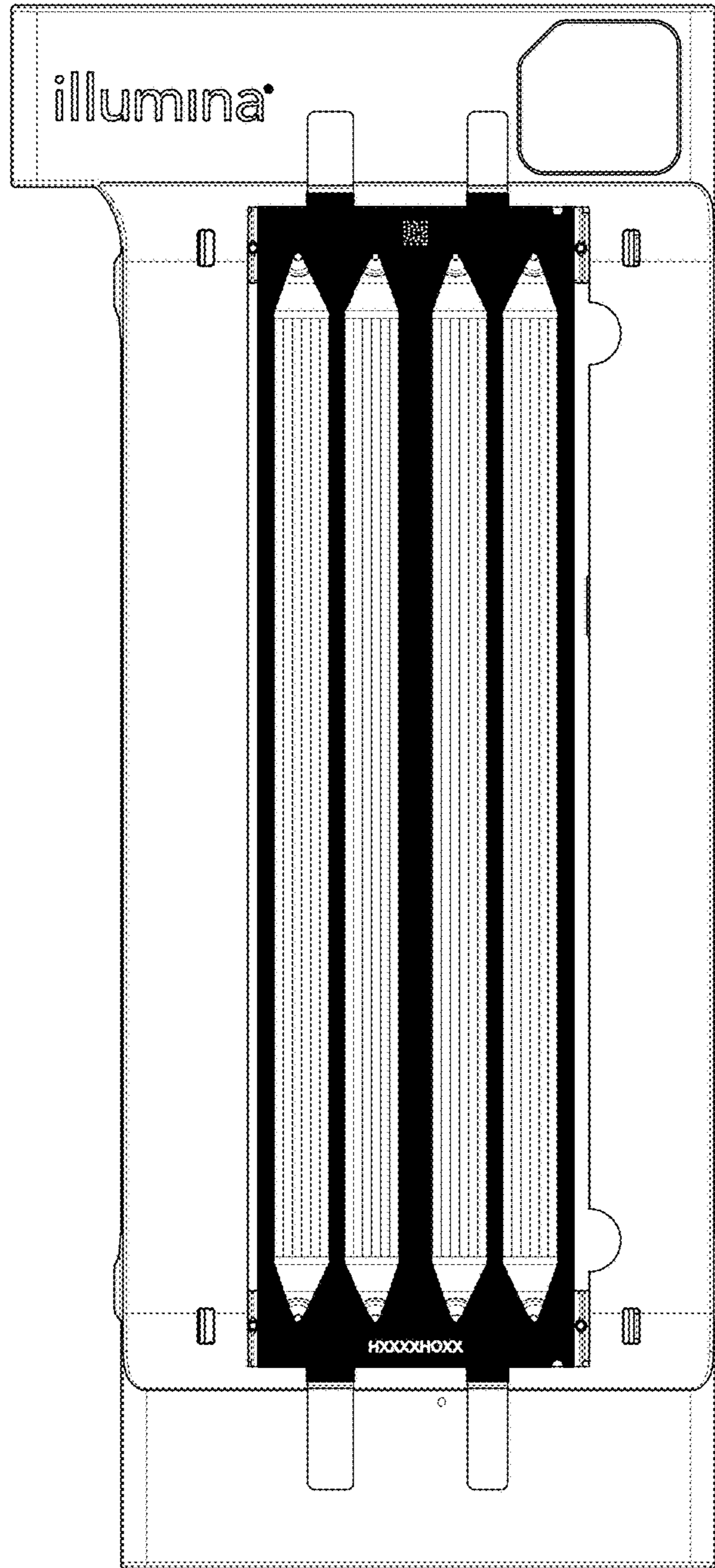

Figure 25

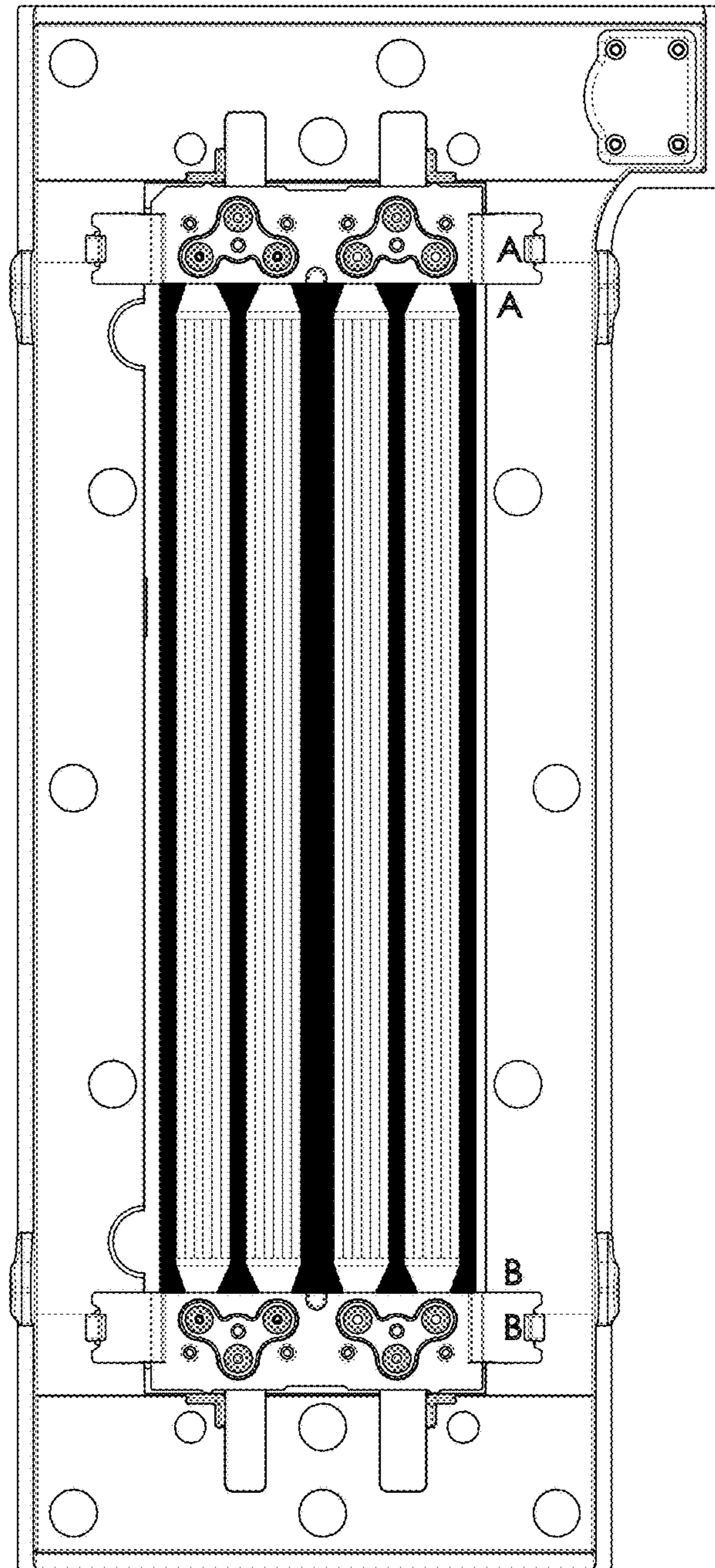

Figure 26

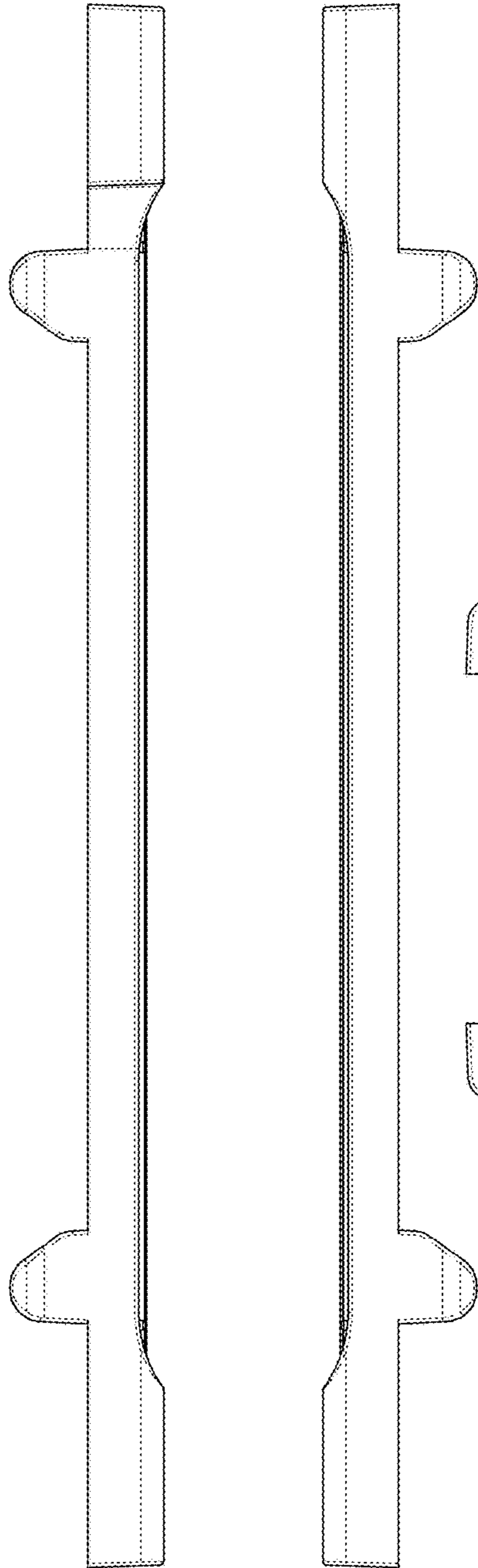

Figure 27 Figure 28

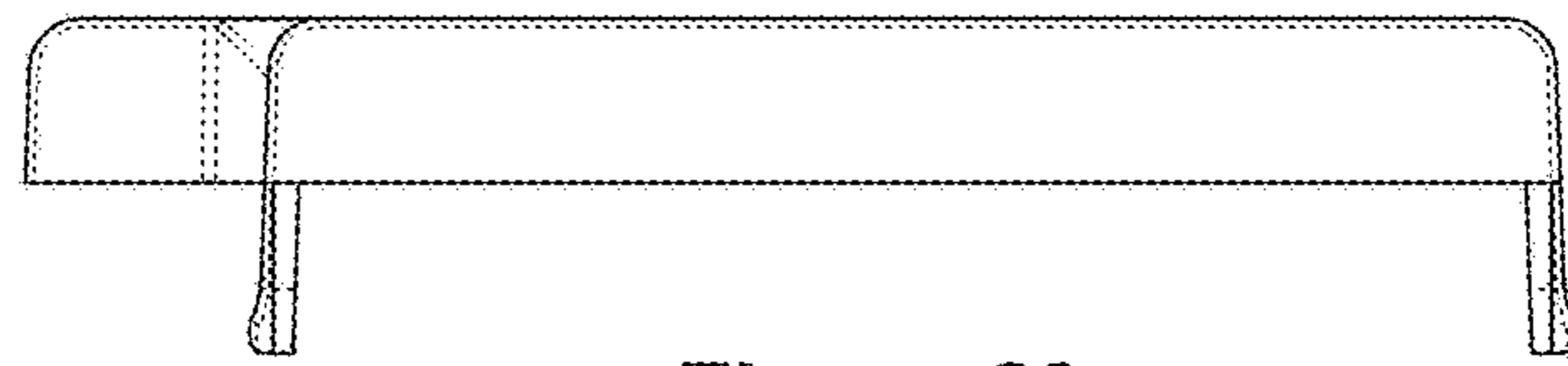

Figure 29

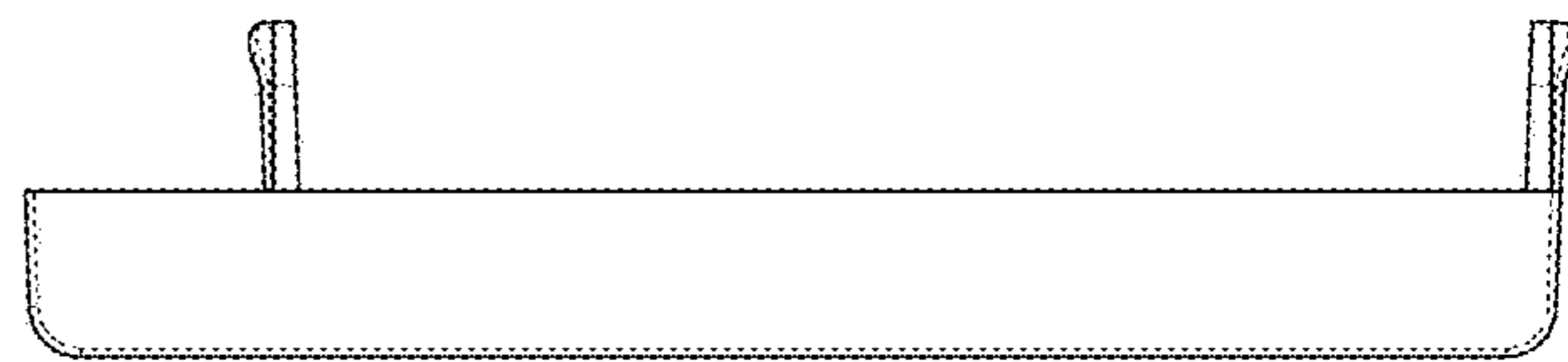

Figure 30

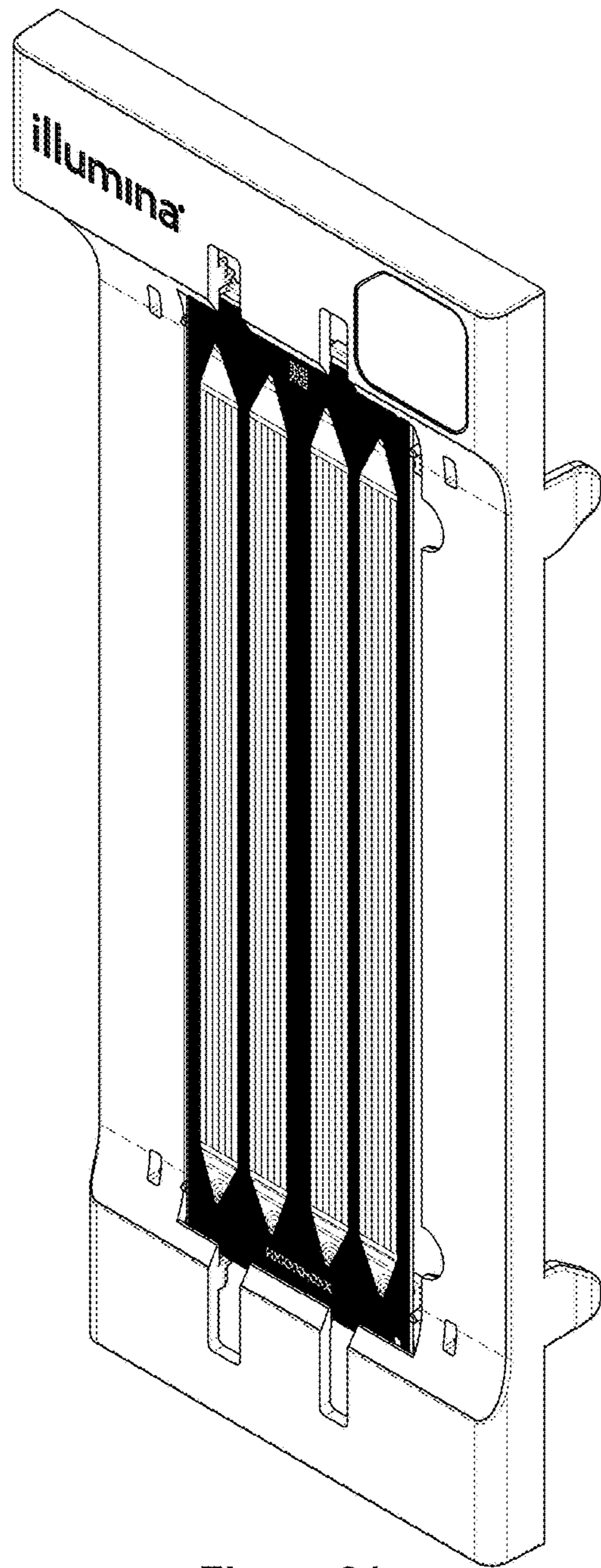

Figure 31

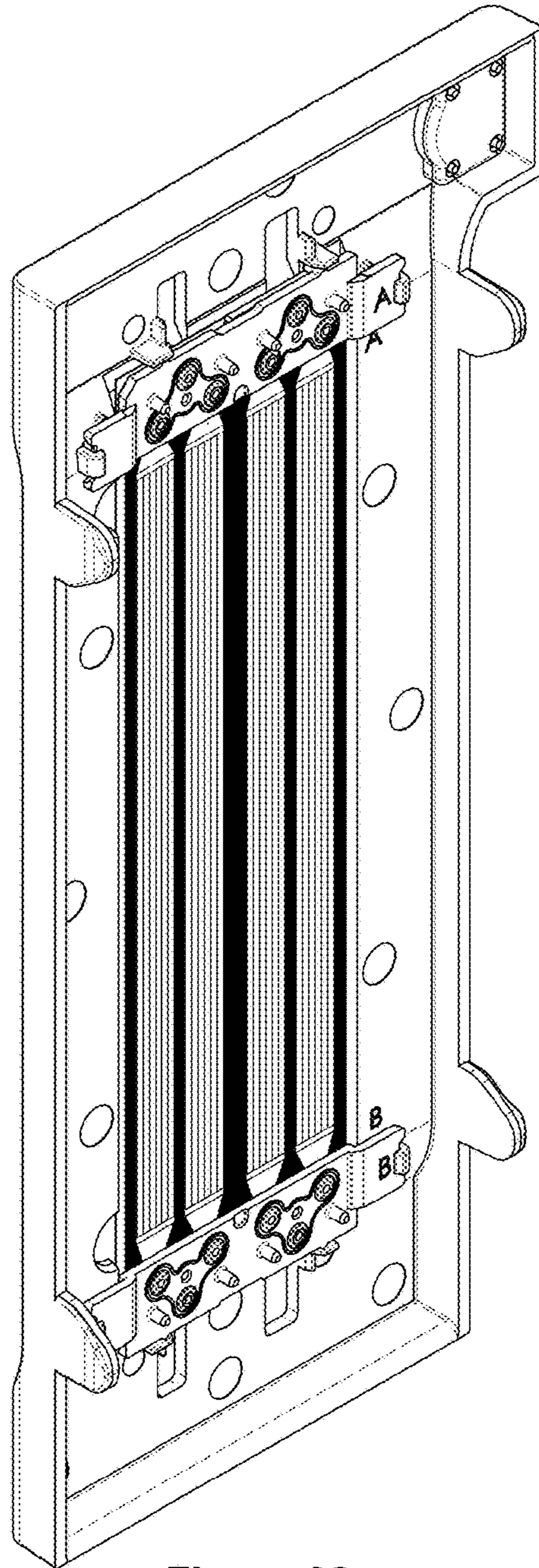

Figure 32