



US00D857169S

(12) **United States Design Patent** (10) **Patent No.:** **US D857,169 S**
Feng (45) **Date of Patent:** **** Aug. 20, 2019**

(54) **FAUCET**
(71) Applicant: **Yadong Feng**, Suzhou (CN)
(72) Inventor: **Yadong Feng**, Suzhou (CN)
(**) Term: **15 Years**
(21) Appl. No.: **29/677,995**
(22) Filed: **Jan. 25, 2019**
(51) **LOC (12) Cl.** **23-01**
(52) **U.S. Cl.**
USPC **D23/238**; D23/256
(58) **Field of Classification Search**
USPC D23/238-243, 249, 255, 257, 250, 252,
D23/254; D8/307-308; D6/550
CPC F16K 31/60; F16K 31/602; F16K 31/605;
F16K 31/607; E03C 1/0412
See application file for complete search history.

D676,938 S * 2/2013 Kwok D23/252
D732,144 S * 6/2015 Bahler
D735,014 S * 7/2015 Groleski D8/308
D790,667 S * 6/2017 Schaubach D23/252
D790,668 S * 6/2017 Schaubach D23/252
D793,839 S * 8/2017 Darmali D8/307
D794,412 S * 8/2017 Darmali D8/306
2004/0011987 A1* 1/2004 Ortega, Jr. F16K 31/602
251/291
2008/0178954 A1* 7/2008 Pinette E03C 1/0404
137/801
2019/0015927 A1* 1/2019 Bhardwaj E03C 1/04

* cited by examiner

Primary Examiner — Robert A Delehanty

(74) *Attorney, Agent, or Firm* — KA Filing LLC; Wayne V. Harper

(57) **CLAIM**

I claim the ornamental design for a faucet, as shown and described.

(56) **References Cited**

U.S. PATENT DOCUMENTS

D80,400 S * 1/1930 Schnell D8/308
D307,045 S * 4/1990 Yost D23/252
D324,416 S * 3/1992 Stairs D23/255
D385,337 S * 10/1997 Spurgeon D23/255
D467,645 S 12/2002 Panis et al.
D510,495 S * 10/2005 Gilbert D6/524
D519,608 S 4/2006 Fritz
D521,604 S 5/2006 Fritz
D524,415 S * 7/2006 Perrin D23/238
D606,170 S * 12/2009 Lammel D23/252
D608,421 S * 1/2010 Gilbert D23/255
D616,071 S * 5/2010 Fakonas D23/252
D651,287 S * 12/2011 Kwok D23/252
D654,148 S * 2/2012 Romero D23/242

DESCRIPTION

FIG. 1 is a perspective view of a faucet showing my new design;
FIG. 2 is a front side view of the faucet as shown in FIG. 1;
FIG. 3 is a back-side view of the faucet as shown in FIG. 1;
FIG. 4 is a top view of the faucet as shown in FIG. 1;
FIG. 5 is a bottom view of the faucet as shown in FIG. 1;
FIG. 6 is a left-side view of the faucet as shown in FIG. 1;
and,
FIG. 7 is a right-side view of the faucet as shown in FIG. 1.
The broken lines are only for environmental purposes and form no part of the claimed design.

1 Claim, 7 Drawing Sheets

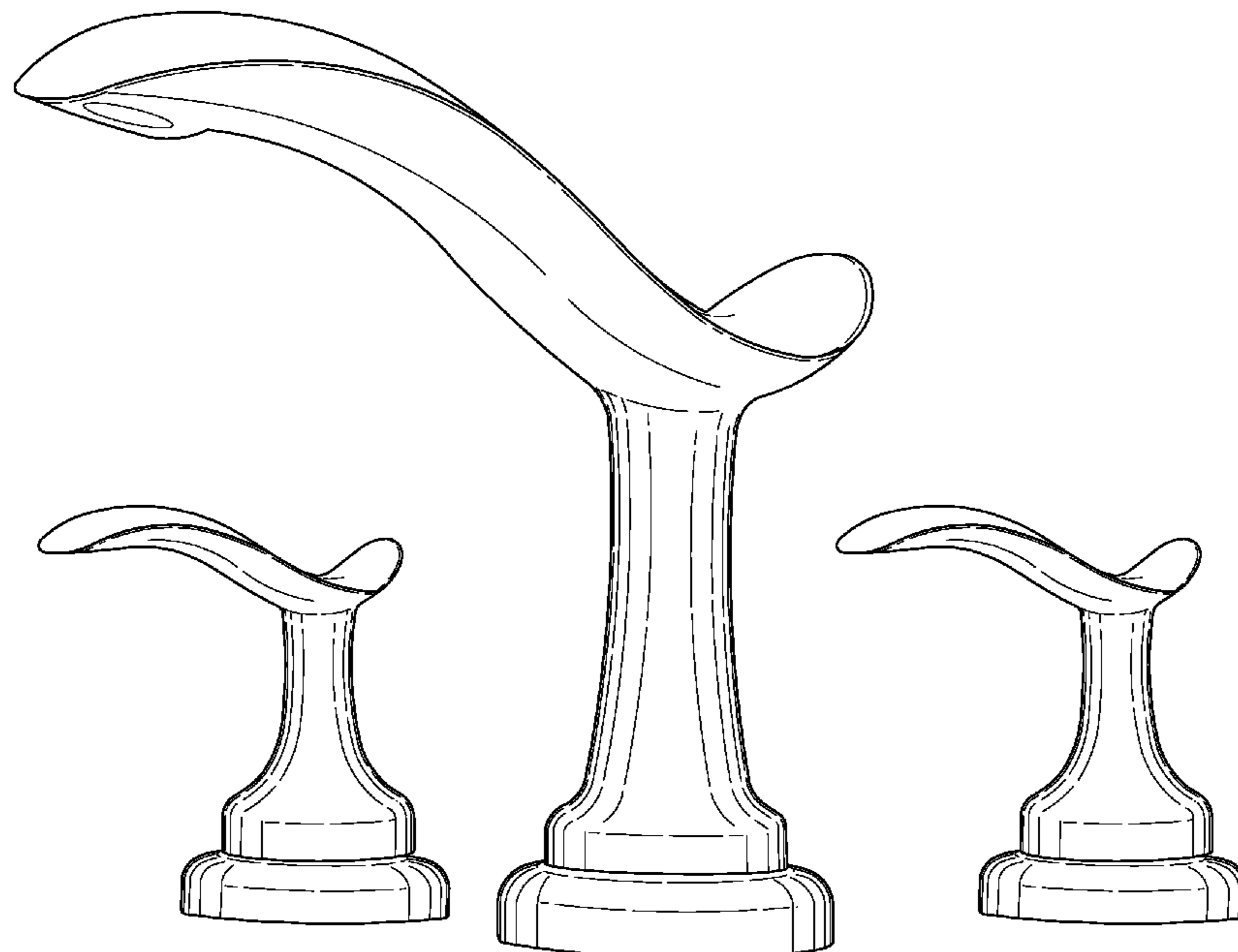

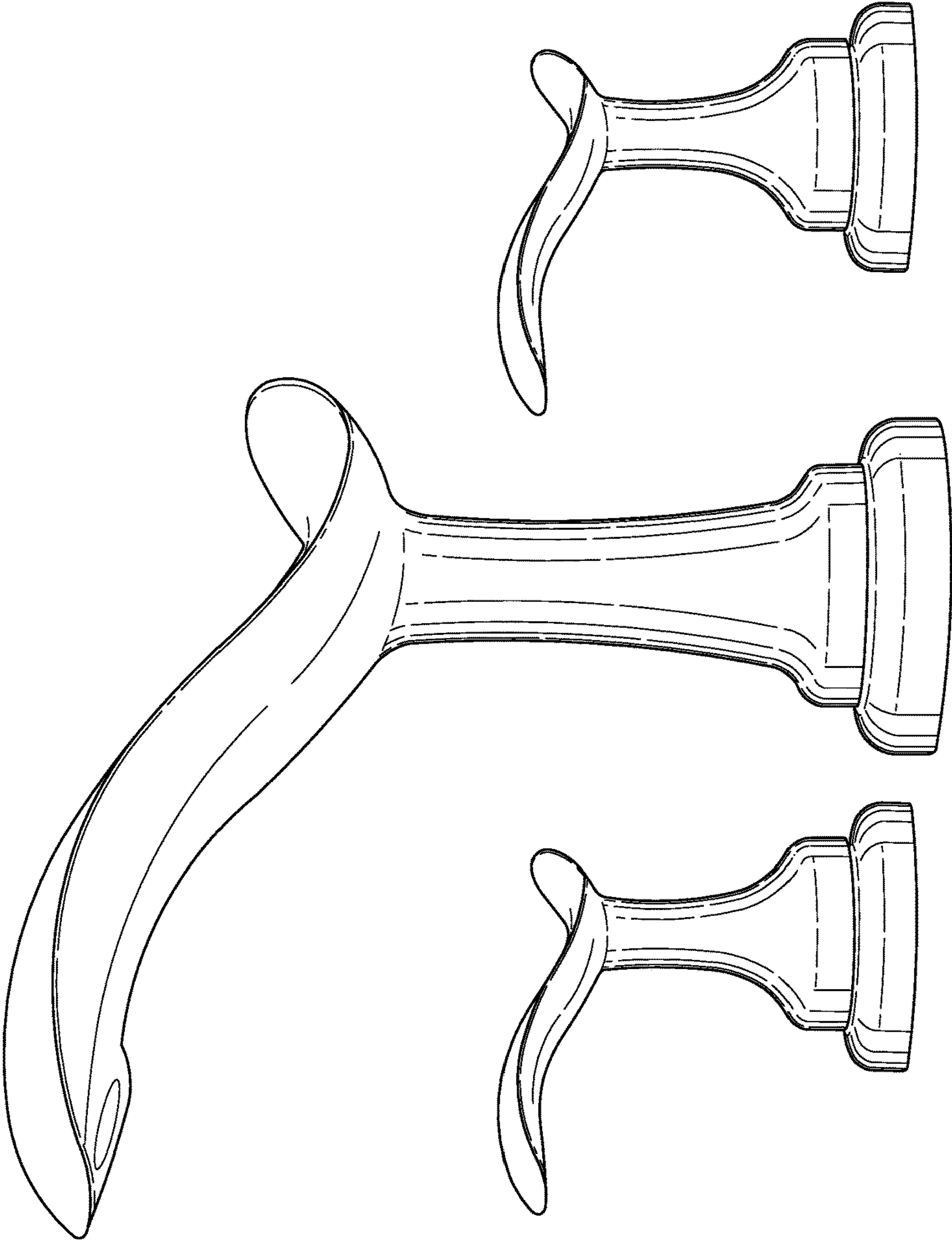

FIG. 1

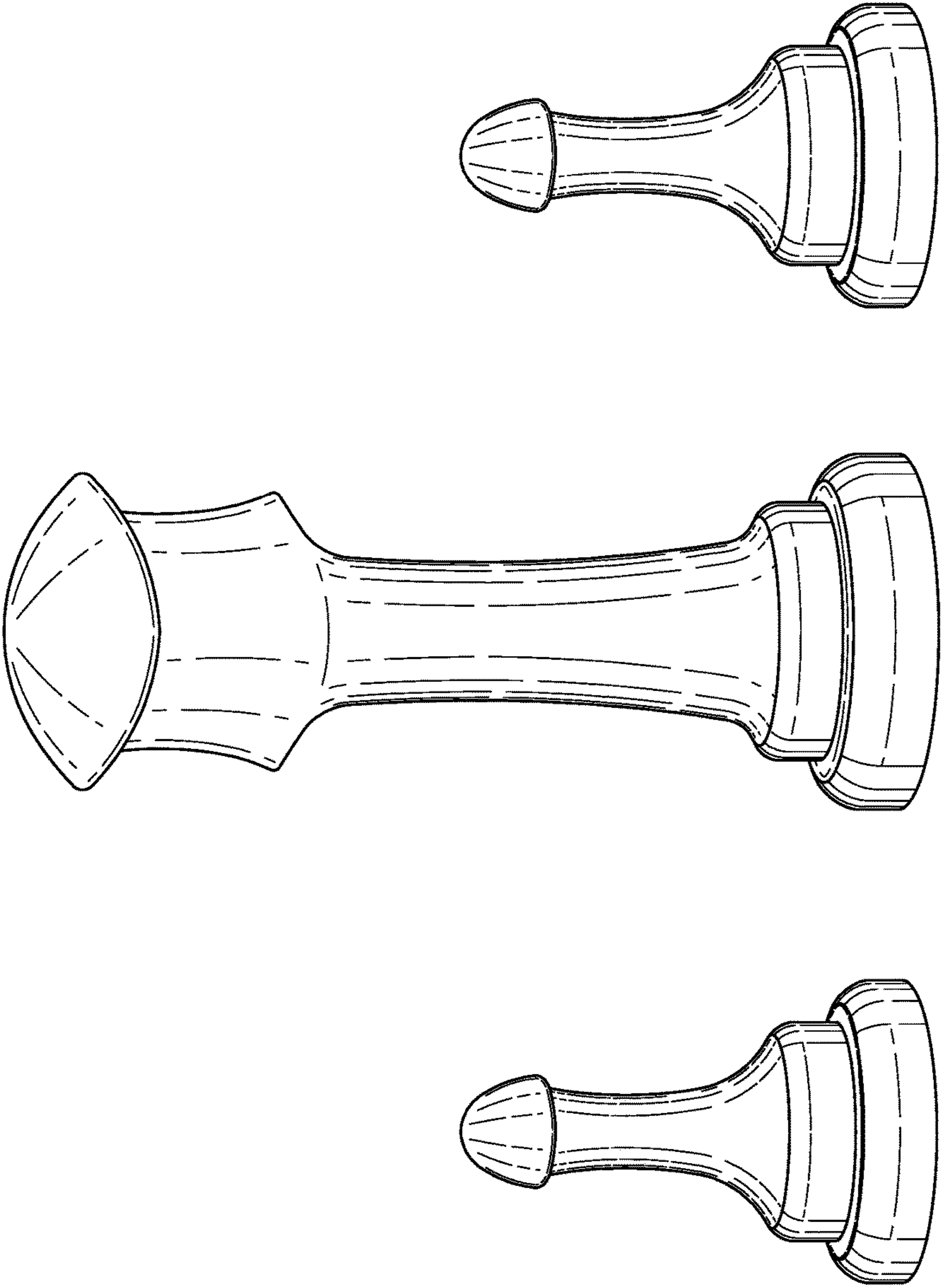

FIG. 2

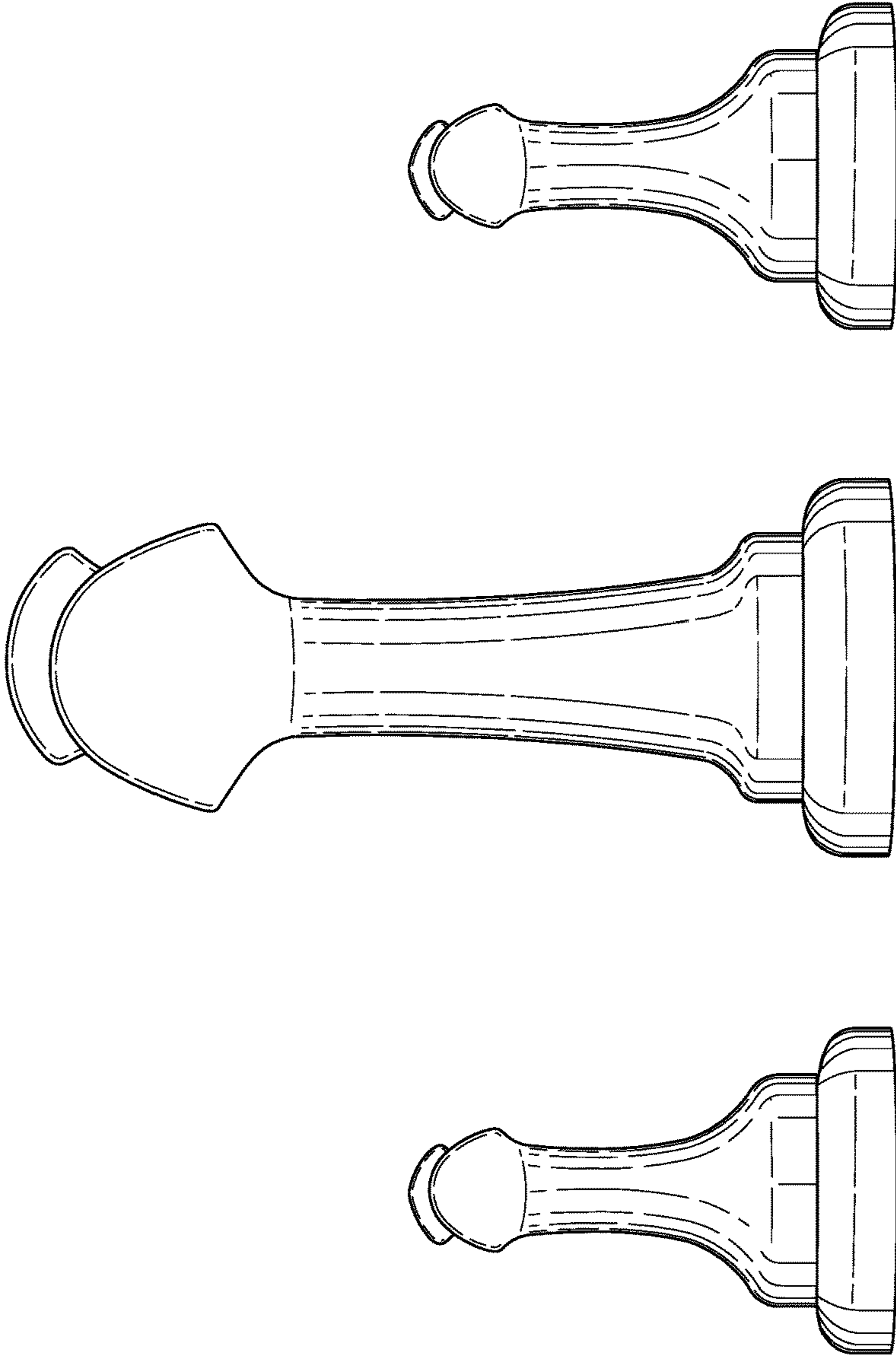

FIG. 3

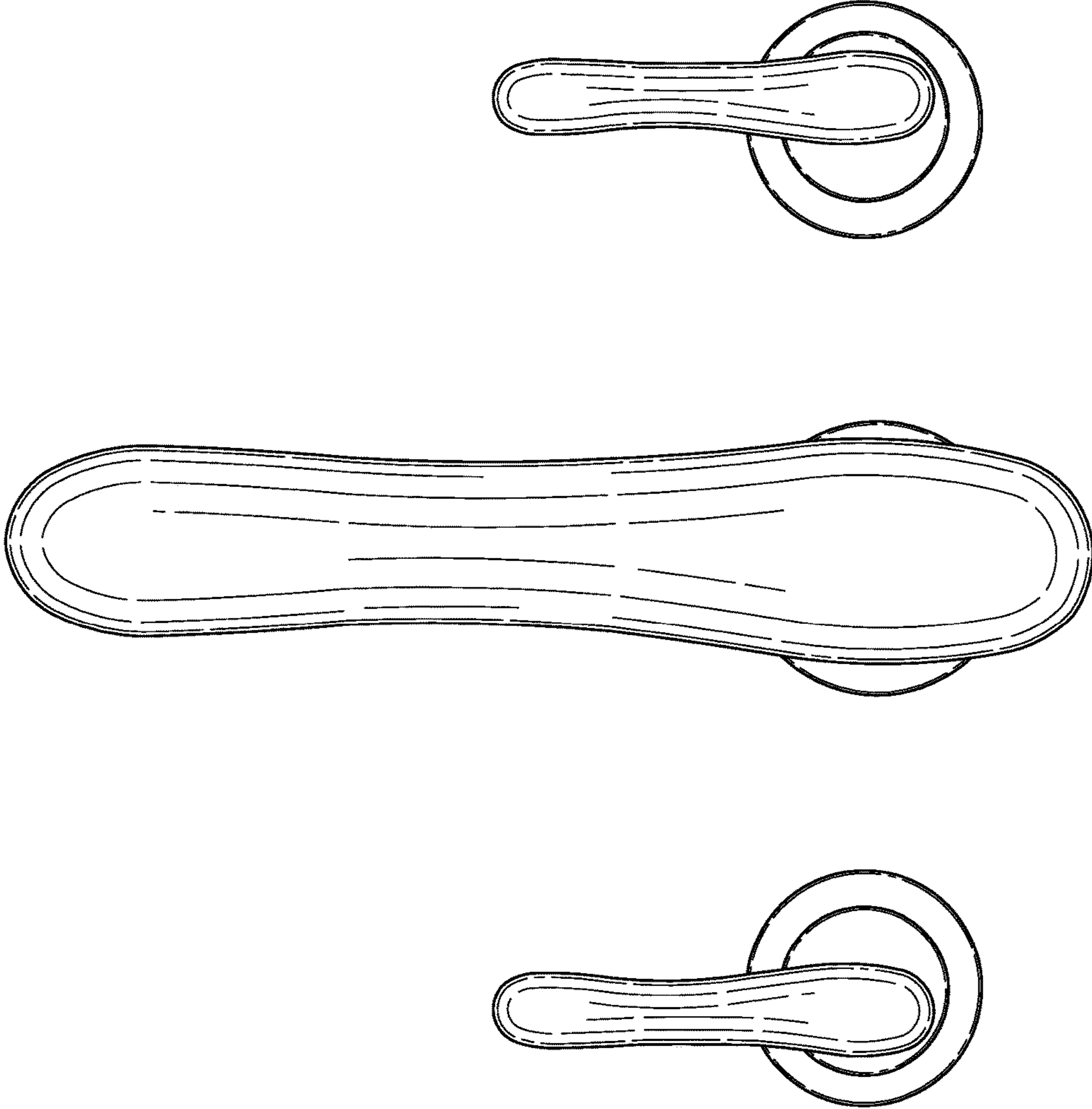

FIG. 4

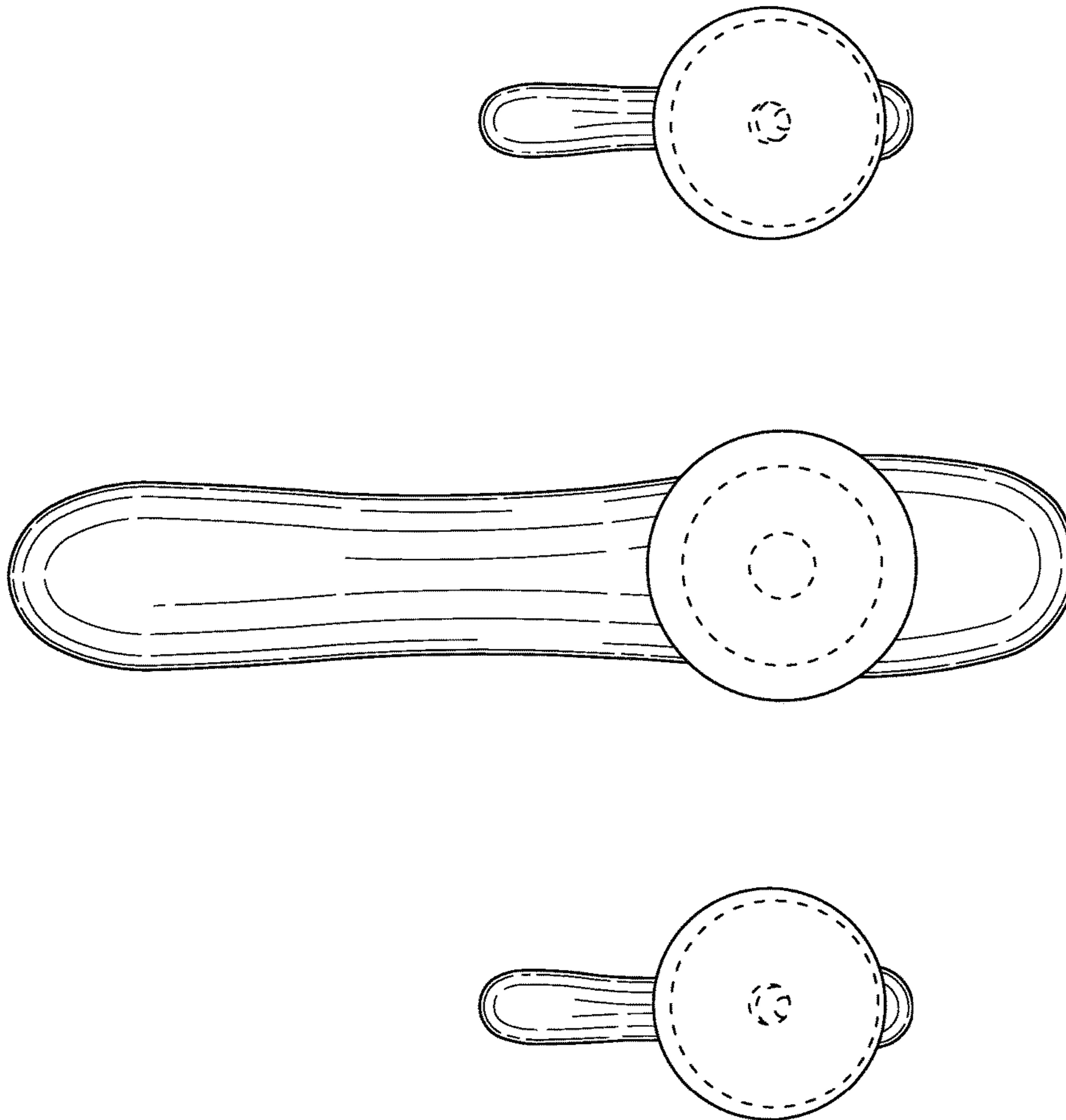

FIG. 5

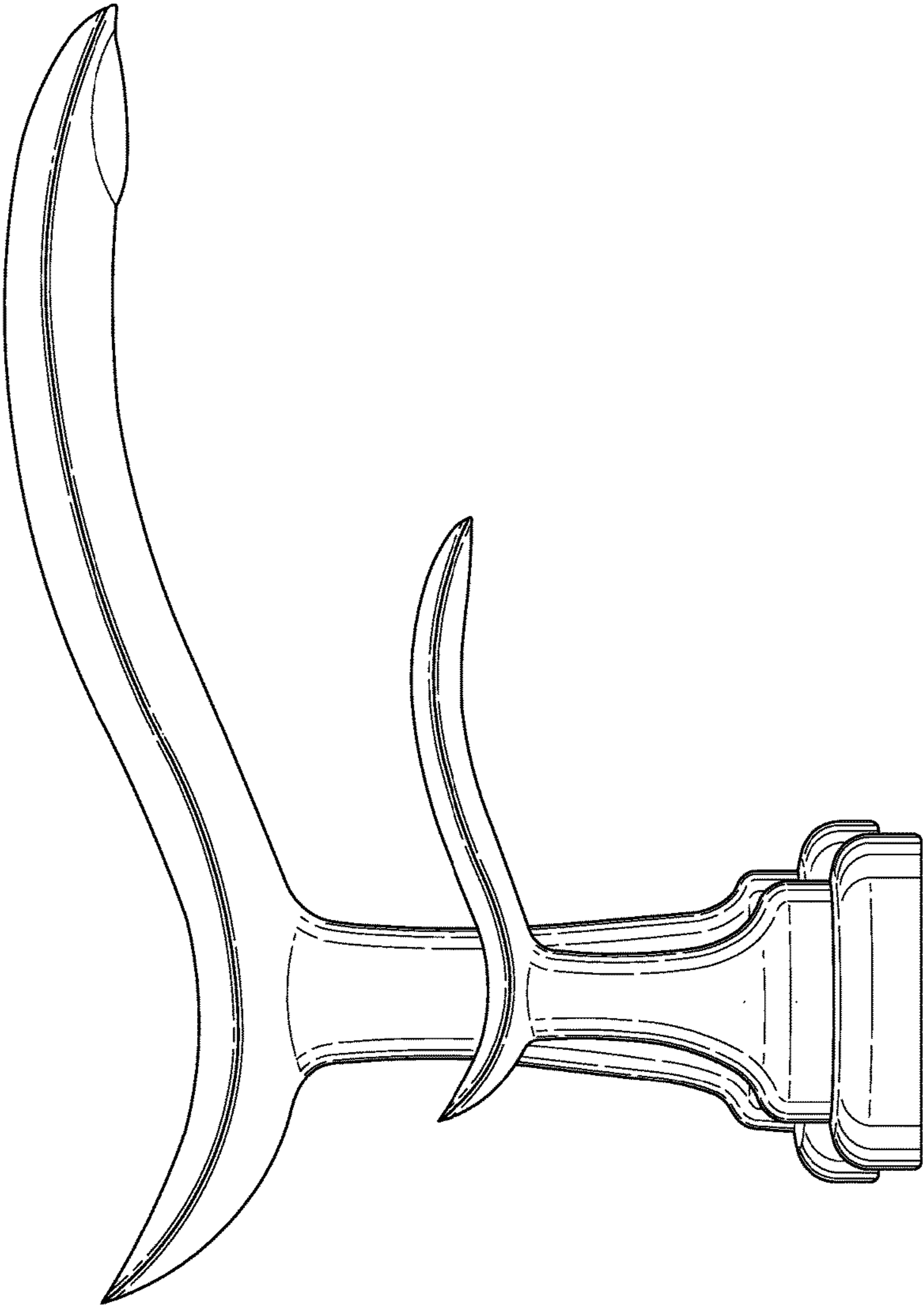

FIG. 6

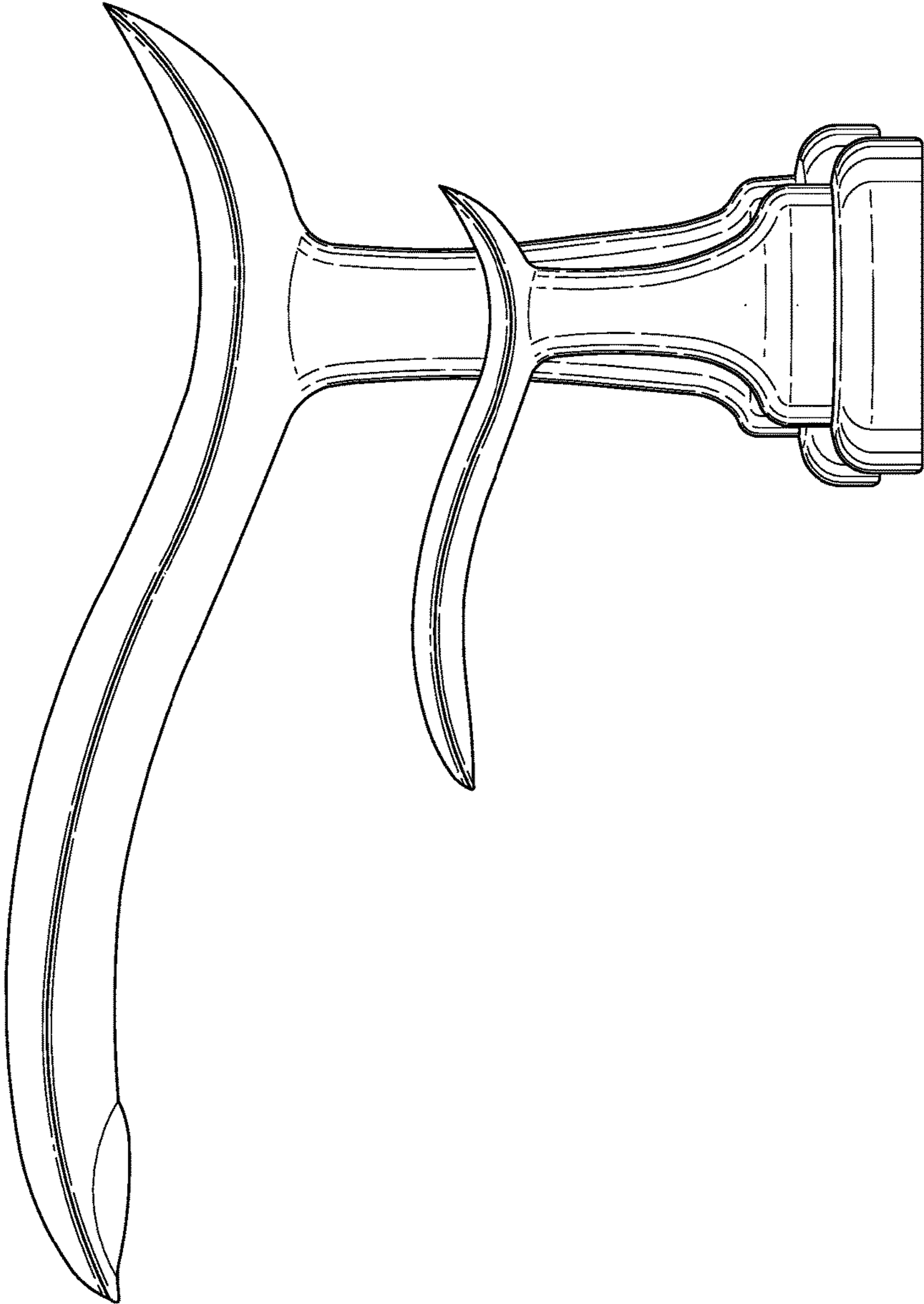

FIG. 7